











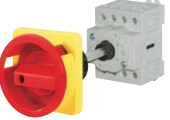

Inhalt		Seite
	Hauptschalter für Einbau 4-Lochbefestigung	280
	Umschalter mit Sperrvorrichtung für Einbau 4-Lochbefestigung	281
	Hauptschalter für Zentralbefestigung	281
	Hauptschalter für Bodenmontage	282
	Hauptschalter-Not-Aus für Einbau 4-Lochbefestigung	286
	Umschalter mit Sperrvorrichtung für Einbau 4-Lochbefestigung	287
	Hauptschalter-Not-Aus für Zentralbefestigung	287
	Hauptschalter-Not-Aus für Bodenmontage	288
	Hauptschalter-Not-Aus für Reiheneinbau	290
	Umschalter mit Sperrvorrichtung für Reiheneinbau	290
	Reparaturschalter, isolierstoffgekapselt	291
	Umschalter mit Sperrvorrichtung	291
	Lasttrennschalter für Einbau, Ein-Ausschalter	292
	Lasttrennschalter für Zentralbefestigung, Ein-Ausschalter	293
	Lasttrennschalter für Bodenmontage	293
	Lasttrennschalter für Reiheneinbau	295
	Lasttrennschalter für Einbau, isolierstoffgekapselt	296
	Zusatzmodule	297
	Technische Daten	299
	Maße	300

Nennwerte

Schutzart von vorne
im eingebauten Zustand

Einbau
4-Lochbefestigung
IP66

Zentralbefestigung
Ø22,5mm
IP66

Typ	Nennbetriebsstrom Therm.			Motor			Schild Lasttrenn- schalter mm	Einbau			Zentralbefestigung		
	I_{th} A	AC21 A	bei U_e V	AC3 3~400V kW	AC23 3~400V A	AC23 3~400V kW		EH4	EHN4	EHN1	Z	ZHN1	ZH1
LTS20	20	20	690	5,5	16	7,5	48 [□]	LTS20 E ¹⁾ ..			LTS20 Z ¹⁾ ..		
LTS25	25	25	690	7,5	20	10	48 [□]	LTS25 E ¹⁾ ..			LTS25 Z ¹⁾ ..		
LTS32	32	32	690	11	25	12,5	48 [□]	LTS32 E ¹⁾ ..			LTS32 Z ¹⁾ ..		
LTS40	40	40	690	15	32	16	48 [□]	LTS40 E ¹⁾ ..			LTS40 Z ¹⁾ ..		
LTS63	63	63	690	18,5	45	22	48 [□]	LTS63 E ¹⁾ ..			-		
LTS80	80	80	690	18,5	45	22	48 [□]	LTS80 E ¹⁾ ..			-		
LTS85	85	85	690	22	60	30	64 [□]	LTS85 E ¹⁾ ..			-		
LTS100	100	100	690	30	72	37	64 [□]	LTS100 E ¹⁾ ..			-		
LTS125	125	125	690	37	85	45	64 [□]	LTS125 E ¹⁾ ..			-		
LT160	160	160	690	45	110	55	88 [□]	LT160 E ¹⁾ ..			-		

Lasttrennschalter LT(S).. 20 - 160A

Der Einsatzbereich der Lasttrennschalter ist überall dort gegeben, wo kompakte EIN-AUS-Schalter mit großer Kontaktöffnung (Trenner) und hohem Kontaktdruck und damit größerer Kurzschlußfestigkeit benötigt werden. Die Anwendung erfolgt daher als

Hauptschalter nach IEC/EN 60204 bzw. VDE0113 mit Sperrvorrichtung, Klemmenabdeckung und zwangsweiser Kontaktbetätigung.

Trennschalter nach IEC/EN 60947-3 und VDE 0660 Teil 107 mit Trennstrecken für 690V.

Motorschalter 3-polig oder 4-polig. Entsprechend IEC/EN 60947-3 bzw. VDE 0660 Teil 107 haben die Schalter der LT(S)-Reihe hohes AC3- und AC23A-Schaltvermögen.

Schaltprogramme

Ein-Ausschalter 3-polig	A3
Ein-Ausschalter 4-polig	A4
Ein-Ausschalter 6-polig	A6
Ein-Ausschalter 8-polig	A8
Umschalter mit 0-Stellung 3-polig	U3
Umschalter mit 0-Stellung 4-polig	U4
Ein-Ausschalter 3-polig	T300 (für LT160)
Ein-Ausschalter 4-polig	T400 (für LT160)

Hauptschalter und Hauptschalter mit Not-Aus-Funktion

Jede Be- und Verarbeitungsmaschine muß nach den Vorschriften IEC/EN 60204 bzw. VDE0113 mit einem Hauptschalter ausgerüstet sein, der die gesamte elektrische Ausrüstung während Reinigungs-, Wartungs- und Reparaturarbeiten sowie bei längeren Stillstandszeiten von allen aktiven Leitern der Netzeinspeisung trennt.

Sind 2 oder mehr Hauptschalter vorgesehen, müssen entsprechende Schutzverriegelungen verwendet werden. Empfehlenswert ist jedoch die Verwendung eines vielpoligen Hauptschalters (Nockenschalter).

Der **Hauptschalter** muß einer der folgenden Arten entsprechen:

- Lasttrennschalter entsprechend IEC/EN 60947-3 und VDE 0660 Teil 107 für Anwendungskategorie AC23-B oder DC-23B.
- Trennschalter mit Hilfskontakt (z.B.: Schaltprogramm A3-10), der auf jeden Fall veranlaßt, daß Schalteinrichtungen die Last vor dem Öffnen der Hauptkontakte des Trenners abschalten.
- Das Ausschaltvermögen muß ausreichend sein, den Strom des größten Motors im blockierten Zustand zusammen mit der Summe der Betriebsströme aller übrigen Motoren und/oder Verbraucher abzuschalten.

Anforderungen:

Trennen der elektrischen Ausrüstung vom Netz, wobei nur eine Aus- und eine Ein-Stellung vorhanden ist, eindeutig gekennzeichnet mit O und I. Er muß in der Aus-Stellung abschließbar sein.

Die Netzklemmen eines Hauptschalters müssen gegen zufälliges Berühren mindestens der Schutzart IP2X entsprechen.

Farbe der Handhabe schwarz oder grau.

Der **Hauptschalter mit Not-Aus-Funktion** muß zusätzlich mit einem roten Schaltergriff ausgerüstet sein, das Frontschild hinter dem Schaltergriff muß gelb gefärbt sein, damit sich der Griff deutlich abhebt.

1) Hauptschalter (H1/H4 Hauptschalter Not-Aus (HN1/HN4))
Lasttrennschalter (ohne H(N)1/4)

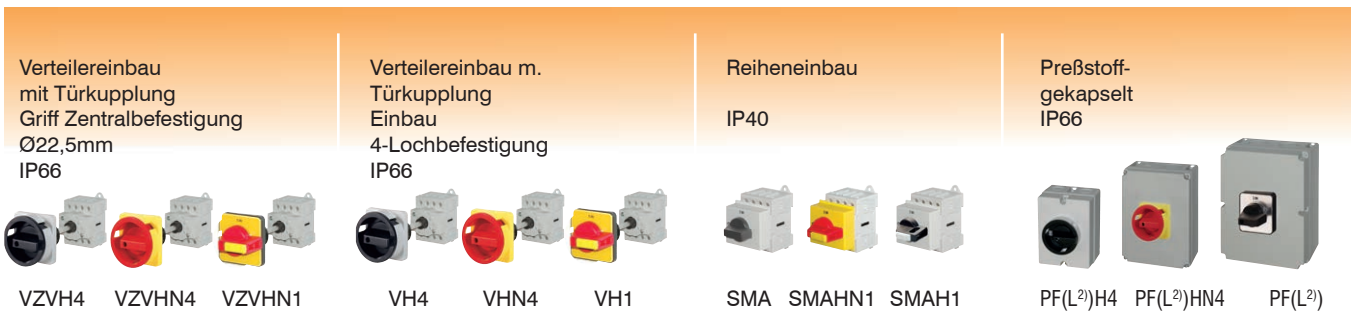

VZVH4	VZVHN4	VZVHN1	VH4	VHN4	VH1	SMA	SMAHN1	SMAH1	PF(L ²)H4	PF(L ²)HN4	PF(L ²)
LTS20 VZV ¹⁾ ..			LTS20 V ¹⁾ ..			LTS20 SMA ¹⁾ ..			LTS20 PF(L ²) ¹⁾ ..		
LTS25 VZV ¹⁾ ..			LTS25 V ¹⁾ ..			LTS25 SMA ¹⁾ ..			LTS25 PF(L ²) ¹⁾ ..		
LTS32 VZV ¹⁾ ..			LTS32 V ¹⁾ ..			LTS32 SMA ¹⁾ ..			LTS32 PF(L ²) ¹⁾ ..		
LTS40 VZV ¹⁾ ..			LTS40 V ¹⁾ ..			LTS40 SMA ¹⁾ ..			LTS40 PF(L ²) ¹⁾ ..		
LTS63 VZV ¹⁾ ..			LTS63 V ¹⁾ ..			LTS63 SMA ¹⁾ ..			LTS63 PFL ¹⁾ ..		
LTS80 VZV ¹⁾ ..			LTS80 V ¹⁾ ..			LTS80 SMA ¹⁾ ..			LTS80 PFL ¹⁾ ..		
LTS85 VZV ¹⁾ ..			LTS85 V ¹⁾ ..			LTS85 SMA ¹⁾ ..			LTS85 PFL ¹⁾ ..		
LTS100 VZV ¹⁾ ..			LTS100 V ¹⁾ ..			LTS100 SMA ¹⁾ ..			LTS100 PFL ¹⁾ ..		
LTS125 VZV ¹⁾ ..			LTS125 V ¹⁾ ..			LTS125 SMA ¹⁾ ..			LTS125 PFL ¹⁾ ..		
-			LT160 V ¹⁾ ..			-			LT160 PF ¹⁾ .. ³⁾		

Approbationen

Land	USA, Kanada / UL	Europa	Russland / EAC	CB/CCA-Zertifikate
Typ				

Lasttrennschalter (UL-Listed as MANUAL MOTOR CONTROLLER and suitable as MOTOR DISCONNECT)

Geräte	USA, Kanada / UL	Europa	Russland / EAC	CB/CCA-Zertifikate
LTS20	o	o	o	o
LTS25	o	o	o	o
LTS32	o	o	o	o
LTS40	o	o	o	o
LTS63	o	o	o	o
LTS80	o	o	o	o
LTS85	o	o	-	-
LTS100	o	o	-	-
LTS125	o	o	-	-
LT160	o	o	-	o

o in Normalausführung approbiert
 / Approbation nicht erforderlich CE
 x zur Approbation eingereicht
 - bisher nicht zur Approbation vorgesehen



Klemmenanschlußschrauben

Geräte	Anschlußart	Schraubendreher	Anzugsdrehmoment	Schutzart
Typ	Schraube mit Zugbügel		Nm	der Anschlußklemmen ⁴⁾
Lasttrennschalter				
LTS20, LTS25				IP20
LTS32, LTS40	M3,5		1,7 - 2,3	IP20
LTS63, LTS80	M5	Pz2	2,8 - 4	IP20
LTS85, LTS100, LTS125	M6	Pz3	1,7 - 4,5	IP20
LT160	M10		14	IP20



1) Hauptschalter (H1/H4 Hauptschalter Not-Aus (HN1/HN4))
 Lasttrennschalter (ohne H(N)1/4)
 2) PFL... größeres Gehäuse
 3) IP. Type..
 4) Schutzart mit angeschlossenem, isoliertem Leiter. Zusatzschutz durch entsprechende Klemmenabdeckung (KLAD).

Schütze, Motorstarter
 Leistungsschalter
 Motorschutzschalter
 Schalter
 AC-Hauptschalter
 DC-Lasttrennschalter
 Befehls- und Meldegeräte
 Vertretungen, Bezugsquellen

Hauptschalter für Einbau 4-Lochbefestigung, absperrbar IP66, us Type 3R

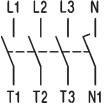
	max. Schlösser	AC21 690V	AC23 3x400V	Schild	Typ	VPE Stk.	Gewicht kg/Stk.
3-polig, Sperrvorrichtung SV1  	2						
		20A	7,5kW	48 ^{□ 1)}	LTS20 EH1 A3	1	0,15
		25A	10kW	48 ^{□ 1)}	LTS25 EH1 A3	1	0,15
		32A	12,5kW	48 ^{□ 1)}	LTS32 EH1 A3	1	0,15
		40A	16kW	48 ^{□ 1)}	LTS40 EH1 A3	1	0,15
		63A	22kW	48 ^{□ 1)}	LTS63 EH1 A3	1	0,17
		80A	22kW	48 ^{□ 1)}	LTS80 EH1 A3	1	0,17

4-polig, Sperrvorrichtung SV1  	2						
		20A	7,5kW	48 ^{□ 1)}	LTS20 EH1 A4	1	0,19
		25A	10kW	48 ^{□ 1)}	LTS25 EH1 A4	1	0,19
		32A	12,5kW	48 ^{□ 1)}	LTS32 EH1 A4	1	0,19
		40A	16kW	48 ^{□ 1)}	LTS40 EH1 A4	1	0,19
		63A	22kW	48 ^{□ 1)}	LTS63 EH1 A4	1	0,21
		80A	22kW	48 ^{□ 1)}	LTS80 EH1 A4	1	0,21

3-polig, Sperrvorrichtung SV4(34)  	3						
		20A	7,5kW	64 ^{□ 2)}	LTS20 EH4 A3	1	0,17
		25A	10kW	64 ^{□ 2)}	LTS25 EH4 A3	1	0,17
		32A	12,5kW	64 ^{□ 2)}	LTS32 EH4 A3	1	0,17
		40A	16kW	64 ^{□ 2)}	LTS40 EH4 A3	1	0,17
		63A	22kW	64 ^{□ 2)}	LTS63 EH4 A3	1	0,19
		80A	22kW	64 ^{□ 2)}	LTS80 EH4 A3	1	0,19
		80A	30kW	64 ^{□ 2)}	LTS85 EH4 A3	1	0,39
		100A	37kW	64 ^{□ 2)}	LTS100 EH4 A3	1	0,39
		125A	45kW	64 ^{□ 2)}	LTS125 EH4 A3	1	0,39

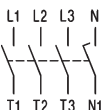
4-polig, Sperrvorrichtung SV4(34)  	3						
		20A	7,5kW	64 ^{□ 2)}	LTS20 EH4 A4	1	0,20
		25A	10kW	64 ^{□ 2)}	LTS25 EH4 A4	1	0,20
		32A	12,5kW	64 ^{□ 2)}	LTS32 EH4 A4	1	0,20
		40A	16kW	64 ^{□ 2)}	LTS40 EH4 A4	1	0,20
		63A	22kW	64 ^{□ 2)}	LTS63 EH4 A4	1	0,23
		80A	22kW	64 ^{□ 2)}	LTS80 EH4 A4	1	0,23
		80A	30kW	64 ^{□ 2)}	LTS85 EH4 A4	1	0,44
		100A	37kW	64 ^{□ 2)}	LTS100 EH4 A4	1	0,44
		125A	45kW	64 ^{□ 2)}	LTS125 EH4 A4	1	0,44

Zusatzmodule siehe Seite 297

Verlängerte Schalterwelle für Schalter für Fronteinbau Typenzusatz: **+VW“x“**

x = Paneelstärke

1) Auf Anfrage auch in Schildgröße 64 [□] erhältlich, Typenzusatz **64** z. B: LTS32 EHN**164** A3

2) Auf Anfrage auch in Schildgröße 88 [□] erhältlich, Typenzusatz **88** z. B: LTS32 EHN**488** A3

Hauptschalter für Einbau 4-Lochbefestigung, absperrrbar IP66, Type 3R

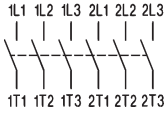
		max. Schlösser	AC21 690V	AC23 3x400V	Schild	Typ	VPE Stk.	Gewicht kg/Stk.
6-polig, Sperrvorrichtung SV4 			20A	7,5kW	64 □	LTS20 EH4 A6	1	0,30
			25A	10kW	64 □	LTS25 EH4 A6	1	0,30
			32A	12,5kW	64 □	LTS32 EH4 A6	1	0,30
			40A	16kW	64 □	LTS40 EH4 A6	1	0,30
			63A	22kW	64 □	LTS63 EH4 A6	1	0,34
			80A	22kW	64 □	LTS80 EH4 A6	1	0,34

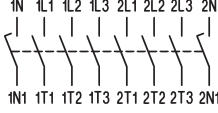
8-polig, Sperrvorrichtung SV4 			20A	7,5kW	64 □	LTS20 EH4 A8	1	0,38
			25A	10kW	64 □	LTS25 EH4 A8	1	0,38
			32A	12,5kW	64 □	LTS32 EH4 A8	1	0,38
			40A	16kW	64 □	LTS40 EH4 A8	1	0,38
			63A	22kW	64 □	LTS63 EH4 A8	1	0,42
			80A	22kW	64 □	LTS80 EH4 A8	1	0,42

Umschalter mit Sperrvorrichtung für Einbau 4-Lochbefestigung, absperrrbar IP66

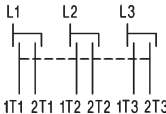
3-polig, Sperrvorrichtung SV4 			20A	7,5kW	64 □	LTS20 EH4 U3	1	0,30
			25A	10kW	64 □	LTS25 EH4 U3	1	0,30
			32A	12,5kW	64 □	LTS32 EH4 U3	1	0,30
			40A	16kW	64 □	LTS40 EH4 U3	1	0,30
			63A	22kW	64 □	LTS63 EH4 U3	1	0,34

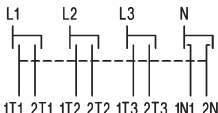
4-polig, Sperrvorrichtung SV4 			20A	7,5kW	64 □	LTS20 EH4 U4	1	0,38
			25A	10kW	64 □	LTS25 EH4 U4	1	0,38
			32A	12,5kW	64 □	LTS32 EH4 U4	1	0,38
			40A	16kW	64 □	LTS40 EH4 U4	1	0,38
			63A	22kW	64 □	LTS63 EH4 U4	1	0,42

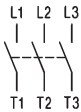

Hauptschalter für Zentralbefestigung, absperrrbar IP66, Type 4X

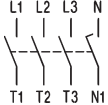
3-polig, Sperrvorrichtung SV1 			20A	7,5kW	48 □	LTS20 ZH1 A3	1	0,16
			25A	10kW	48 □	LTS25 ZH1 A3	1	0,16
			32A	12,5kW	48 □	LTS32 ZH1 A3	1	0,16
			40A	16kW	48 □	LTS40 ZH1 A3	1	0,16

4-polig, Sperrvorrichtung SV1 			20A	7,5kW	48 □	LTS20 ZH1 A4	1	0,20
			25A	10kW	48 □	LTS25 ZH1 A4	1	0,20
			32A	12,5kW	48 □	LTS32 ZH1 A4	1	0,20
			40A	16kW	48 □	LTS40 ZH1 A4	1	0,20

Zusatzmodule siehe Seite 297

Hauptschalter, Bodenmontage mit Türkupplung, Sperrvorrichtung für Zentralbefestigung Ø22mm
Einbautiefe nachträglich einstellbar (Lieferlänge, X_{max} siehe unten) IP66, cULus Type 4X

	max. Schösser	AC21 690V	AC23 3x400V	Schild	Typ	VPE Stk.	Gewicht kg/Stk.
3-polig, Sperrvorrichtung SV4 							
		20A	7,5kW	64 □	LTS20 VZVH4 A3	1	0,19
		25A	10kW	64 □	LTS25 VZVH4 A3	1	0,19
		32A	12,5kW	64 □	LTS32 VZVH4 A3	1	0,19
		40A	16kW	64 □	LTS40 VZVH4 A3	1	0,19
		63A	22kW	64 □	LTS63 VZVH4 A3	1	0,22
		80A	22kW	64 □	LTS80 VZVH4 A3	1	0,22
		85A	30kW	64 □	LTS85 VZVH4 A3	1	0,40
		100A	37kW	64 □	LTS100 VZVH4 A3	1	0,40
		125A	45kW	64 □	LTS125 VZVH4 A3	1	0,40
4-polig, Sperrvorrichtung SV4 							
		20A	7,5kW	64 □	LTS20 VZVH4 A4	1	0,20
		25A	10kW	64 □	LTS25 VZVH4 A4	1	0,20
		32A	12,5kW	64 □	LTS32 VZVH4 A4	1	0,20
		40A	16kW	64 □	LTS40 VZVH4 A4	1	0,20
		63A	22kW	64 □	LTS63 VZVH4 A4	1	0,26
		80A	22kW	64 □	LTS80 VZVH4 A4	1	0,26
		85A	30kW	64 □	LTS85 VZVH4 A4	1	0,45
		100A	37kW	64 □	LTS100 VZVH4 A4	1	0,45
		125A	45kW	64 □	LTS125 VZVH4 A4	1	0,45
6-polig, Sperrvorrichtung SV4 							
		20A	7,5kW	64 □	LTS20 VZVH4 A6	1	0,32
		25A	10kW	64 □	LTS25 VZVH4 A6	1	0,32
		32A	12,5kW	64 □	LTS32 VZVH4 A6	1	0,32
		40A	16kW	64 □	LTS40 VZVH4 A6	1	0,32
		63A	22kW	64 □	LTS63 VZVH4 A6	1	0,37
		80A	22kW	64 □	LTS80 VZVH4 A6	1	0,37
8-polig, Sperrvorrichtung SV4 							
		20A	7,5kW	64 □	LTS20 VZVH4 A8	1	0,34
		25A	10kW	64 □	LTS25 VZVH4 A8	1	0,34
		32A	12,5kW	64 □	LTS32 VZVH4 A8	1	0,34
		40A	16kW	64 □	LTS40 VZVH4 A8	1	0,34
		63A	22kW	64 □	LTS63 VZVH4 A8	1	0,45
	80A	22kW	64 □	LTS80 VZVH4 A8	1	0,45	

Einbautiefe
Zentralbefestigung Ø22mm
LTS.. VZV..

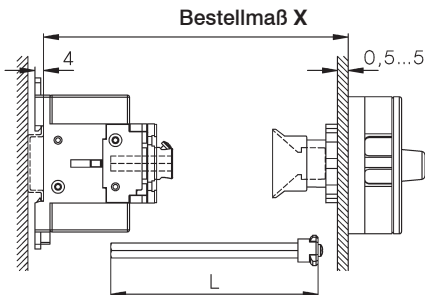

Typ		X min	X max	L
LTS20-80 VZV..	3, 4-polig	91	190	X - 40±3
LTS20-80 VZV..	6, 8-polig	111	190	X - 60±3
LTS85-125 VZV..	3, 4-polig	95	190	X - 44±3

4-Lochbefestigung
LTS.. V(H).. (3, 4-polig)

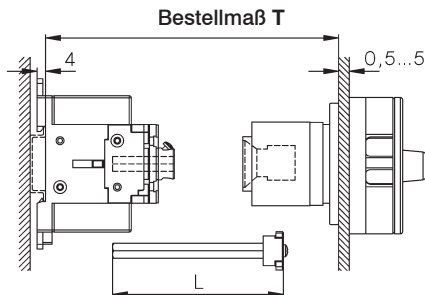

Typ		T min	T max	L	Type	T min	T max
LTS20-80 VH..		111	190	T - 60±3	LTS160 VH..	120	450
LTS85-125 VH..		115	190	T - 64±3			

größere X- und T-Maße (max. 380mm für LTS..) auf Anfrage

Hauptschalter, Bodenmontage mit Türkupplung, Sperrvorrichtung für 4-Lochbefestigung
 Einbautiefe nachträglich einstellbar (Lieferlänge, T_{max} siehe Seite 271) IP66, cUL_{us} Type 4X

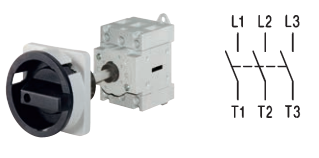
	max. Schösser	AC21 690V	AC23 3x400V	Schild	Typ	VPE Stk.	Gewicht kg/Stk.
3-polig, Sperrvorrichtung SV4(34) 							
	20A	7,5kW	64 □ ¹⁾	LTS20 VH4 A3	1	0,20	
	25A	10kW	64 □ ¹⁾	LTS25 VH4 A3	1	0,20	
	32A	12,5kW	64 □ ¹⁾	LTS32 VH4 A3	1	0,20	
	40A	16kW	64 □ ¹⁾	LTS40 VH4 A3	1	0,20	
	63A	22kW	64 □ ¹⁾	LTS63 VH4 A3	1	0,24	
	80A	22kW	64 □ ¹⁾	LTS80 VH4 A3	1	0,24	
	85A	30kW	64 □ ¹⁾	LTS85 VH4 A3	1	0,40	
	100A	37kW	64 □ ¹⁾	LTS100 VH4 A3	1	0,40	
	125A	45kW	64 □ ¹⁾	LTS125 VH4 A3	1	0,40	
	160A	55kW	88 □	LT160 VH34 T300	1	1,38	

	max. Schösser	AC21 690V	AC23 3x400V	Schild	Typ	VPE Stk.	Gewicht kg/Stk.
4-polig, Sperrvorrichtung SV4(34) 							
	20A	7,5kW	64 □ ¹⁾	LTS20 VH4 A4	1	0,21	
	25A	10kW	64 □ ¹⁾	LTS25 VH4 A4	1	0,21	
	32A	12,5kW	64 □ ¹⁾	LTS32 VH4 A4	1	0,21	
	40A	16kW	64 □ ¹⁾	LTS40 VH4 A4	1	0,21	
	63A	22kW	64 □ ¹⁾	LTS63 VH4 A4	1	0,28	
	80A	22kW	64 □ ¹⁾	LTS80 VH4 A4	1	0,28	
	85A	30kW	64 □ ¹⁾	LTS85 VH4 A4	1	0,45	
	100A	37kW	64 □ ¹⁾	LTS100 VH4 A4	1	0,45	
	125A	45kW	64 □ ¹⁾	LTS125 VH4 A4	1	0,45	
	160A	55kW	88 □	LT160 VH34 T400	1	1,77	

Hauptschalter, Bodenmontage mit Stecktürkupplung für Zentralbefestigung Ø22mm
 Einbautiefe nicht einstellbar, Maß X bei Bestellung angeben IP66, cUL_{us} Type 4X

	max. Schösser	AC21 690V	AC23 3x400V	Schild	Typ	VPE Stk.	Gewicht kg/Stk.
4-polig, Sperrvorrichtung SV4 							
	20A	7,5kW	64 □	LTS20 VZH4 A4 X..	1	0,18	
	25A	10kW	64 □	LTS25 VZH4 A4 X..	1	0,18	
	32A	12,5kW	64 □	LTS32 VZH4 A4 X..	1	0,18	
	40A	16kW	64 □	LTS40 VZH4 A4 X..	1	0,18	
	63A	22kW	64 □	LTS63 VZH4 A4 X..	1	0,25	
	80A	22kW	64 □	LTS80 VZH4 A4 X..	1	0,25	

Einbautiefe Maß X unbedingt angeben

Typ	Vorzugswerte für X
LT.. VZH..	80, 85, 104, 129 (Toleranz -3, +1,5)

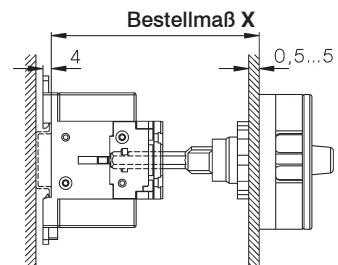



Zusatzmodule siehe Seite 297



1) Auf Anfrage auch in Schildgröße 88 □ erhältlich Typenzusatz **88** z. B: LTS32 VH4**88** A3

Schütze, Motorstarter
Leistungsschalter
Motorschutzschalter
Schalter
AC-Hauptschalter
DC-Lasttrennschalter
Befehls- und Meldegeräte
Vertretungen, Bezugsquellen



Hauptschalter, für Reiheneinbau, absperrrbar IP40,  Open Type

	max. Schlösser	AC21 690V	AC23 3x400V	Schild	Typ	VPE Stk.	Gewicht kg/Stk.
3-polig, Sperrvorrichtung SV1 							
		20A	7,5kW	52x45	LTS20 SMAH1 A3 ²⁾	1	0,15
		25A	10kW	52x45	LTS25 SMAH1 A3 ²⁾	1	0,15
		32A	12,5kW	52x45	LTS32 SMAH1 A3 ²⁾	1	0,15
		40A	16kW	52x45	LTS40 SMAH1 A3 ²⁾	1	0,15
		63A	22kW	52x45	LTS63 SMAH1 A3 ²⁾	1	0,18
		80A	22kW	52x45	LTS80 SMAH1 A3 ²⁾	1	0,18
		85A	30kW	78x45	LTS85 SMAH1 A3	1	0,37
		100A	37kW	78x45	LTS100 SMAH1 A3	1	0,37
		125A	45kW	78x45	LTS125 SMAH1 A3	1	0,37



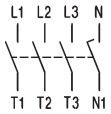

4-polig, Sperrvorrichtung SV1 							
		20A	7,5kW	52x45	LTS20 SMAH1 A4 ²⁾	1	0,16
		25A	10kW	52x45	LTS25 SMAH1 A4 ²⁾	1	0,16
		32A	12,5kW	52x45	LTS32 SMAH1 A4 ²⁾	1	0,16
		40A	16kW	52x45	LTS40 SMAH1 A4 ²⁾	1	0,16
		63A	22kW	52x45	LTS63 SMAH1 A4 ²⁾	1	0,21
		80A	22kW	52x45	LTS80 SMAH1 A4 ²⁾	1	0,21
		85A	30kW	78x45	LTS85 SMAH1 A4	1	0,42
		100A	37kW	78x45	LTS100 SMAH1 A4	1	0,42
		125A	45kW	78x45	LTS125 SMAH1 A4	1	0,42

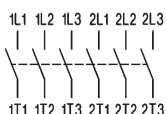

6-polig, Sperrvorrichtung SV1(64) 							
		20A	7,5kW	52x45	LTS20 SMAH1 A6	1	0,29
		25A	10kW	52x45	LTS25 SMAH1 A6	1	0,29
		32A	12,5kW	52x45	LTS32 SMAH1 A6	1	0,29
		40A	16kW	52x45	LTS40 SMAH1 A6	1	0,29
		63A	22kW	97x45	LTS63 SMAH1 A6 ¹⁾	1	0,34
		80A	22kW	97x45	LTS80 SMAH1 A6 ¹⁾	1	0,34



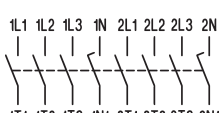

8-polig, Sperrvorrichtung SV164 							
		20A	7,5kW	97x45	LTS20 SMAH1 A8	1	0,31
		25A	10kW	97x45	LTS25 SMAH1 A8	1	0,31
		32A	12,5kW	97x45	LTS32 SMAH1 A8	1	0,31
		40A	16kW	97x45	LTS40 SMAH1 A8	1	0,31
		63A	22kW	126x45	LTS63 SMAH1 A8	1	0,42
		80A	22kW	126x45	LTS80 SMAH1 A8	1	0,42

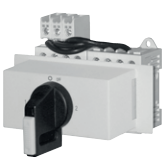

Umschalter mit Sperrvorrichtung für Reiheneinbau, absperrrbar

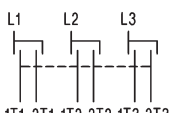
3-polig, Sperrvorrichtung SV164 							
		20A	7,5kW	97x45	LTS20 SMAH1 U3	1	0,29
		25A	10kW	97x45	LTS25 SMAH1 U3	1	0,29
		32A	12,5kW	97x45	LTS32 SMAH1 U3	1	0,29
		40A	16kW	97x45	LTS40 SMAH1 U3	1	0,29
		63A	22kW	97x45	LTS63 SMAH1 U3	1	0,34

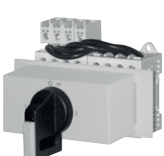

4-polig, Sperrvorrichtung SV164 							
		20A	7,5kW	97x45	LTS20 SMAH1 U4	1	0,31
		25A	10kW	97x45	LTS25 SMAH1 U4	1	0,31
		32A	12,5kW	97x45	LTS32 SMAH1 U4	1	0,31
		40A	16kW	97x45	LTS40 SMAH1 U4	1	0,31
		63A	22kW	126x45	LTS63 SMAH1 U4	1	0,42

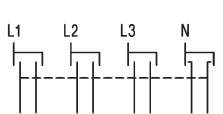











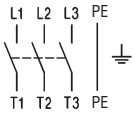

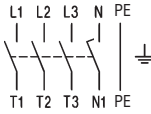
1) mit Sperrvorrichtung SV164

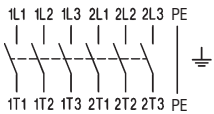
2) **Hauptschalter-Not-Aus, für Reiheneinbau**, absperrrbar mit **niedrigem Griff**, IP40

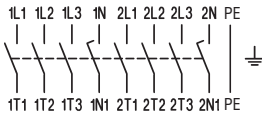

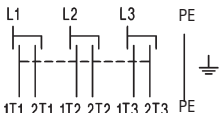

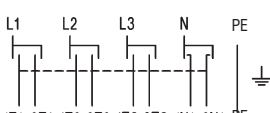





Typ mit Typenzusatz „+SV1N“ z.B.: **LTS40 SMAH1 A3 +SV1**

Reparaturschalter isolierstoffgekapselt, absperrbar IP66, cUL_{us} Type 4X

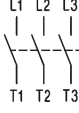
	max. Schlösser	AC21 690V	AC23 3x400V	Schild	Typ	VPE Stk.	Gewicht kg/Stk.	
3-polig, Sperrvorrichtung SV4(34) 								
 		20A	7,5kW	64 \square	LTS20 PF(L ¹)H4 A3	1	0,32	
		25A	10kW	64 \square	LTS25 PF(L ¹)H4 A3	1	0,32	
		32A	12,5kW	64 \square	LTS32 PF(L ¹)H4 A3	1	0,32	
		40A	16kW	64 \square	LTS40 PF(L ¹)H4 A3	1	0,32	
		63A	22kW	64 \square	LTS63 PFLH4 A3	1	0,60	
		80A	22kW	64 \square	LTS80 PFLH4 A3	1	0,60	
		85A	30kW	64 \square	LTS85 PFLH4 A3	1	0,78	
		100A	37kW	64 \square	LTS100 PFLH4 A3	1	0,78	
	Größeres Gehäuse Typ: ..PFL..	auf Anfrage	125A	45kW	64 \square	LTS125 PFLH4 A3	1	0,78
		auf Anfrage	160A	55kW	88 \square	LT160 PFH34 T300	1	2,09
4-polig, Sperrvorrichtung SV4(34) 								
 		20A	7,5kW	64 \square	LTS20 PF(L ¹)H4 A4	1	0,33	
		25A	10kW	64 \square	LTS25 PF(L ¹)H4 A4	1	0,33	
		32A	12,5kW	64 \square	LTS32 PF(L ¹)H4 A4	1	0,33	
		40A	16kW	64 \square	LTS40 PF(L ¹)H4 A4	1	0,33	
		63A	22kW	64 \square	LTS63 PFLH4 A4	1	0,64	
		80A	22kW	64 \square	LTS80 PFLH4 A4	1	0,64	
		85A	30kW	64 \square	LTS85 PFLH4 A4	1	0,83	
		100A	37kW	64 \square	LTS100 PFLH4 A4	1	0,83	
	Größeres Gehäuse Typenzusatz +PF3	auf Anfrage	125A	45kW	64 \square	LTS125 PFLH4 A4	1	0,83
	+PF3/M50	auf Anfrage	160A	55kW	88 \square	LT160 PFH34 T400	1	2,47
6-polig, Sperrvorrichtung SV4 								
 		20A	7,5kW	64 \square	LTS20 PFLH4 A6	1	1,39	
		25A	10kW	64 \square	LTS25 PFLH4 A6	1	1,39	
		32A	12,5kW	64 \square	LTS32 PFLH4 A6	1	1,39	
		40A	16kW	64 \square	LTS40 PFLH4 A6	1	1,39	
		63A	22kW	64 \square	LTS63 PFLH4 A6	1	1,42	
		80A	22kW	64 \square	LTS80 PFLH4 A6	1	1,42	
	Anbauerschraubung M50/40							
	+PF3/M50	auf Anfrage						
	8-polig, Sperrvorrichtung SV4 							
	 		20A	7,5kW	64 \square	LTS20 PFLH4 A8	1	1,44
		25A	10kW	64 \square	LTS25 PFLH4 A8	1	1,44	
		32A	12,5kW	64 \square	LTS32 PFLH4 A8	1	1,44	
		40A	16kW	64 \square	LTS40 PFLH4 A8	1	1,44	
		63A	22kW	64 \square	LTS63 PFLH4 A8	1	1,50	
		80A	22kW	64 \square	LTS80 PFLH4 A8	1	1,50	
Anbauerschraubung M50/40								
+PF3/M50		auf Anfrage						
Umschalter mit Sperrvorrichtung, absperrbar								
3-polig, Sperrvorrichtung SV4 								
 		20A	7,5kW	64 \square	LTS20 PFLH4 U3	1	1,39	
		25A	10kW	64 \square	LTS25 PFLH4 U3	1	1,39	
		32A	12,5kW	64 \square	LTS32 PFLH4 U3	1	1,39	
		40A	16kW	64 \square	LTS40 PFLH4 U3	1	1,39	
		63A	22kW	64 \square	LTS63 PFLH4 U3	1	1,42	
		80A	22kW	64 \square	LTS80 PFLH4 U3	1	1,42	
4-polig, Sperrvorrichtung SV4 								
 		20A	7,5kW	64 \square	LTS20 PFLH4 U4	1	1,44	
		25A	10kW	64 \square	LTS25 PFLH4 U4	1	1,44	
		32A	12,5kW	64 \square	LTS32 PFLH4 U4	1	1,44	
		40A	16kW	64 \square	LTS40 PFLH4 U4	1	1,44	
		63A	22kW	64 \square	LTS63 PFLH4 U4	1	1,50	
		80A	22kW	64 \square	LTS80 PFLH4 U4	1	1,50	

1) PFL.... größerer Anschlußraum

Hauptschalter-Not-Aus, für Einbau 4-Lochbefestigung, absperrbar IP66,  Type 3R

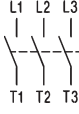
	max. Schösser	AC21 690V	AC23 3x400V	Schild	Typ	VPE Stk.	Gewicht kg/Stk.
3-polig, Sperrvorrichtung SV1 							
 	20A	7,5kW	48 ^{□ 1)}	LTS20 EHN1 A3	1	0,15	
	25A	10kW	48 ^{□ 1)}	LTS25 EHN1 A3	1	0,15	
	32A	12,5kW	48 ^{□ 1)}	LTS32 EHN1 A3	1	0,15	
	40A	16kW	48 ^{□ 1)}	LTS40 EHN1 A3	1	0,15	
	63A	22kW	48 ^{□ 1)}	LTS63 EHN1 A3	1	0,17	
	80A	22kW	48 ^{□ 1)}	LTS80 EHN1 A3	1	0,17	
	4-polig, Sperrvorrichtung SV1 						
 	20A	7,5kW	48 ^{□ 1)}	LTS20 EHN1 A4	1	0,19	
	25A	10kW	48 ^{□ 1)}	LTS25 EHN1 A4	1	0,19	
	32A	12,5kW	48 ^{□ 1)}	LTS32 EHN1 A4	1	0,19	
	40A	16kW	48 ^{□ 1)}	LTS40 EHN1 A4	1	0,19	
	63A	22kW	48 ^{□ 1)}	LTS63 EHN1 A4	1	0,21	
	80A	22kW	48 ^{□ 1)}	LTS80 EHN1 A4	1	0,21	
3-polig, Sperrvorrichtung SV4(34) 							
 	20A	7,5kW	64 ^{□ 2)}	LTS20 EHN4 A3	1	0,17	
	25A	10kW	64 ^{□ 2)}	LTS25 EHN4 A3	1	0,17	
	32A	12,5kW	64 ^{□ 2)}	LTS32 EHN4 A3	1	0,17	
	40A	16kW	64 ^{□ 2)}	LTS40 EHN4 A3	1	0,17	
	63A	22kW	64 ^{□ 2)}	LTS63 EHN4 A3	1	0,19	
	80A	22kW	64 ^{□ 2)}	LTS80 EHN4 A3	1	0,19	
	85A	30kW	64 ^{□ 2)}	LTS85 EHN4 A3	1	0,39	
	100A	37kW	64 ^{□ 2)}	LTS100 EHN4 A3	1	0,39	
125A	45kW	64 ^{□ 2)}	LTS125 EHN4 A3	1	0,39		
160A	55kW	88 [□]	LT160 EHN34 T300	1	1,16		
4-polig, Sperrvorrichtung SV4(34) 							
 	20A	7,5kW	64 ^{□ 2)}	LTS20 EHN4 A4	1	0,20	
	25A	10kW	64 ^{□ 2)}	LTS25 EHN4 A4	1	0,20	
	32A	12,5kW	64 ^{□ 2)}	LTS32 EHN4 A4	1	0,20	
	40A	16kW	64 ^{□ 2)}	LTS40 EHN4 A4	1	0,20	
	63A	22kW	64 ^{□ 2)}	LTS63 EHN4 A4	1	0,23	
	80A	22kW	64 ^{□ 2)}	LTS80 EHN4 A4	1	0,23	
	85A	30kW	64 ^{□ 2)}	LTS85 EHN4 A4	1	0,44	
	100A	37kW	64 ^{□ 2)}	LTS100 EHN4 A4	1	0,44	
125A	45kW	64 ^{□ 2)}	LTS125 EHN4 A4	1	0,44		
160A	55kW	88 [□]	LT160 EHN34 T400	1	1,55		

Zusatzmodule siehe Seite 297





Verlängerte Schalterwelle für Schalter für Fronteinbau Typenzusatz: **+VW“x“**

x = Paneelstärke



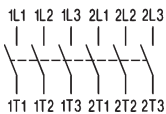

1) Auf Anfrage auch in Schildgröße 64 [□] erhältlich, Typenzusatz **64** z. B: LTS32 EHN**164** A3

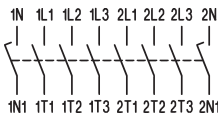
2) Auf Anfrage auch in Schildgröße 88 [□] erhältlich, Typenzusatz **88** z. B: LTS32 EHN**488** A3



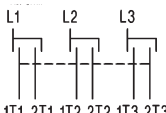

Hauptschalter-Not-Aus, für Einbau 4-Lochbefestigung, absperrbar IP66, Type 3R

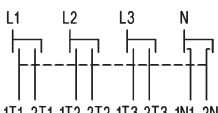
	max. Schlösser	AC21 690V	AC23 3x400V	Schild	Typ	VPE Stk.	Gewicht kg/Stk.
6-polig, Sperrvorrichtung SV4 							
		20A	7,5kW	64 □	LTS20 EHN4 A6	1	0,30
		25A	10kW	64 □	LTS25 EHN4 A6	1	0,30
		32A	12,5kW	64 □	LTS32 EHN4 A6	1	0,30
		40A	16kW	64 □	LTS40 EHN4 A6	1	0,30
		63A	22kW	64 □	LTS63 EHN4 A6	1	0,34
		80A	22kW	64 □	LTS80 EHN4 A6	1	0,34
8-polig, Sperrvorrichtung SV4 							
		20A	7,5kW	64 □	LTS20 EHN4 A8	1	0,38
		25A	10kW	64 □	LTS25 EHN4 A8	1	0,38
		32A	12,5kW	64 □	LTS32 EHN4 A8	1	0,38
		40A	16kW	64 □	LTS40 EHN4 A8	1	0,38
		63A	22kW	64 □	LTS63 EHN4 A8	1	0,42
		80A	22kW	64 □	LTS80 EHN4 A8	1	0,42

Umschalter mit Sperrvorrichtung für Einbau 4-Lochbefestigung, absperrbar IP66

	max. Schlösser	AC21 690V	AC23 3x400V	Schild	Typ	VPE Stk.	Gewicht kg/Stk.
3-polig, Sperrvorrichtung SV4 							
		20A	7,5kW	64 □	LTS20 EHN4 U3	1	0,30
		25A	10kW	64 □	LTS25 EHN4 U3	1	0,30
		32A	12,5kW	64 □	LTS32 EHN4 U3	1	0,30
		40A	16kW	64 □	LTS40 EHN4 U3	1	0,30
		63A	22kW	64 □	LTS63 EHN4 U3	1	0,34
4-polig, Sperrvorrichtung SV4 							
		20A	7,5kW	64 □	LTS20 EHN4 U4	1	0,38
		25A	10kW	64 □	LTS25 EHN4 U4	1	0,38
		32A	12,5kW	64 □	LTS32 EHN4 U4	1	0,38
		40A	16kW	64 □	LTS40 EHN4 U4	1	0,38
		63A	22kW	64 □	LTS63 EHN4 U4	1	0,42

Hauptschalter-Not-Aus, für Zentralbefestigung, absperrbar IP66 Type 4X

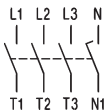
	max. Schlösser	AC21 690V	AC23 3x400V	Schild	Typ	VPE Stk.	Gewicht kg/Stk.
3-polig, Sperrvorrichtung SV1 							
		20A	7,5kW	48 □	LTS20 ZHN1 A3	1	0,16
		25A	10kW	48 □	LTS25 ZHN1 A3	1	0,16
		32A	12,5kW	48 □	LTS32 ZHN1 A3	1	0,16
		40A	16kW	48 □	LTS40 ZHN1 A3	1	0,16
4-polig, Sperrvorrichtung SV1 							
		20A	7,5kW	48 □	LTS20 ZHN1 A4	1	0,20
		25A	10kW	48 □	LTS25 ZHN1 A4	1	0,20
		32A	12,5kW	48 □	LTS32 ZHN1 A4	1	0,20
		40A	16kW	48 □	LTS40 ZHN1 A4	1	0,20

Zusatzmodule siehe Seite 297

Hauptschalter-Not-Aus, Bodenmontage mit Türkupplung für Zentralbefestigung Ø22mm
 Einbautiefe nachträglich einstellbar (Lieferlänge, X_{max} siehe unten) IP66,  us Type 4X

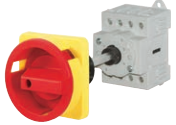
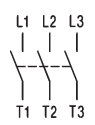
	max. Schösser	AC21 690V	AC23 3x400V	Schild	Typ	VPE Stk.	Gewicht kg/Stk.
3-polig, Sperrvorrichtung SV4  		20A	7,5kW	64 ▢	LTS20 VZVHN4 A3	1	0,19
		25A	10kW	64 ▢	LTS25 VZVHN4 A3	1	0,19
		32A	12,5kW	64 ▢	LTS32 VZVHN4 A3	1	0,19
		40A	16kW	64 ▢	LTS40 VZVHN4 A3	1	0,19
		63A	22kW	64 ▢	LTS63 VZVHN4 A3	1	0,22
		80A	22kW	64 ▢	LTS80 VZVHN4 A3	1	0,22
		85A	30kW	64 ▢	LTS85 VZVHN4 A3	1	0,40
		100A	37kW	64 ▢	LTS100 VZVHN4 A3	1	0,40
		125A	45kW	64 ▢	LTS125 VZVHN4 A3	1	0,40

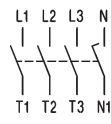
4-polig, Sperrvorrichtung SV4  		20A	7,5kW	64 ▢	LTS20 VZVHN4 A4	1	0,20
		25A	10kW	64 ▢	LTS25 VZVHN4 A4	1	0,20
		32A	12,5kW	64 ▢	LTS32 VZVHN4 A4	1	0,20
		40A	16kW	64 ▢	LTS40 VZVHN4 A4	1	0,20
		63A	22kW	64 ▢	LTS63 VZVHN4 A4	1	0,26
		80A	22kW	64 ▢	LTS80 VZVHN4 A4	1	0,26
		85A	30kW	64 ▢	LTS85 VZVHN4 A4	1	0,45
		100A	37kW	64 ▢	LTS100 VZVHN4 A4	1	0,45
		125A	45kW	64 ▢	LTS125 VZVHN4 A4	1	0,45

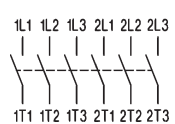
6-polig, Sperrvorrichtung SV4  		20A	7,5kW	64 ▢	LTS20 VZVHN4 A6	1	0,32
		25A	10kW	64 ▢	LTS25 VZVHN4 A6	1	0,32
		32A	12,5kW	64 ▢	LTS32 VZVHN4 A6	1	0,32
		40A	16kW	64 ▢	LTS40 VZVHN4 A6	1	0,32
		63A	22kW	64 ▢	LTS63 VZVHN4 A6	1	0,37
		80A	22kW	64 ▢	LTS80 VZVHN4 A6	1	0,37

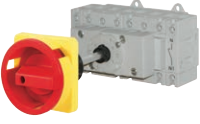
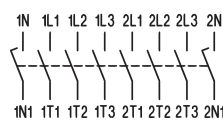
8-polig, Sperrvorrichtung SV4  		20A	7,5kW	64 ▢	LTS20 VZVHN4 A8	1	0,34
		25A	10kW	64 ▢	LTS25 VZVHN4 A8	1	0,34
		32A	12,5kW	64 ▢	LTS32 VZVHN4 A8	1	0,34
		40A	16kW	64 ▢	LTS40 VZVHN4 A8	1	0,34
		63A	22kW	64 ▢	LTS63 VZVHN4 A8	1	0,45
		80A	22kW	64 ▢	LTS80 VZVHN4 A8	1	0,45

Einbautiefe
Zentralbefestigung Ø22mm
LTS.. VZV..

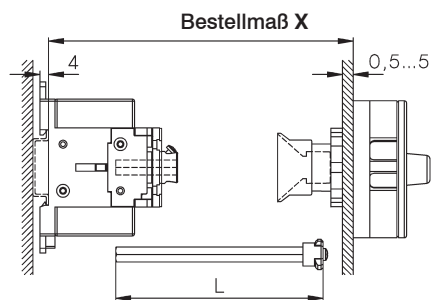

Typ		X min	X max	L
LTS20-80 VZV..	3, 4-polig	91 -	190	X - 40±3
LTS20-80 VZV..	6, 8-polig	111 -	190	X - 60±3
LTS85-125 VZV..	3, 4-polig	95-	190	X - 44±3

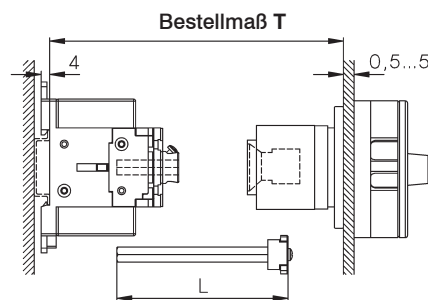

4-Lochbefestigung
LTS.. V(HN).. (3, 4-polig)



Typ		T min	T max	L	Typ	T min	T max
LTS20-80 VH..		111 -	190	T - 60±3	LTS20-80 VZV..		
LTS85-125 VH..		115 -	190	T - 64±3	LTS85-125 VZV..		
					LT160 VH..	120 -	450

größere X- und T-Maße (max. 380mm für LTS..) auf Anfrage

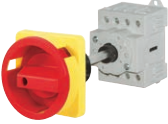
Hauptschalter-Not-Aus, Bodenmontage mit Türkupplung für 4-Lochbefestigung
Einbautiefe nachträglich einstellbar (Lieferlänge, T_{max} siehe Seite 282) IP66, cUL_{us} Type 4X

	max. Schlösser	AC21 690V	AC23 3x400V	Schild	Typ	VPE Stk.	Gewicht kg/Stk.
3-polig, Sperrvorrichtung SV4(34) ⚡⚡⚡							
 	20A	7,5kW		64 □ ¹⁾	LTS20 VHN4 A3	1	0,20
	25A	10kW		64 □ ¹⁾	LTS25 VHN4 A3	1	0,20
	32A	12,5kW		64 □ ¹⁾	LTS32 VHN4 A3	1	0,20
	40A	16kW		64 □ ¹⁾	LTS40 VHN4 A3	1	0,20
	63A	22kW		64 □ ¹⁾	LTS63 VHN4 A3	1	0,24
	80A	22kW		64 □ ¹⁾	LTS80 VHN4 A3	1	0,24
	85A	30kW		64 □ ¹⁾	LTS85 VHN4 A3	1	0,40
	100A	37kW		64 □ ¹⁾	LTS100 VHN4 A3	1	0,40
	125A	45kW		64 □ ¹⁾	LTS125 VHN4 A3	1	0,40
	160A	55kW		88 □	LT160 VHN34 T300	1	1,38

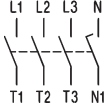
4-polig, Sperrvorrichtung SV4(34) ⚡⚡⚡⚡							
 	20A	7,5kW		64 □ ¹⁾	LTS20 VHN4 A4	1	0,21
	25A	10kW		64 □ ¹⁾	LTS25 VHN4 A4	1	0,21
	32A	12,5kW		64 □ ¹⁾	LTS32 VHN4 A4	1	0,21
	40A	16kW		64 □ ¹⁾	LTS40 VHN4 A4	1	0,21
	63A	22kW		64 □ ¹⁾	LTS63 VHN4 A4	1	0,28
	80A	22kW		64 □ ¹⁾	LTS80 VHN4 A4	1	0,28
	85A	30kW		64 □ ¹⁾	LTS85 VHN4 A4	1	0,45
	100A	37kW		64 □ ¹⁾	LTS100 VHN4 A4	1	0,45
	125A	45kW		64 □ ¹⁾	LTS125 VHN4 A4	1	0,45
	160A	55kW		88 □	LT160 VHN34 T400	1	1,77

Hauptschalter-Not-Aus, Bodenmontage mit Stecktürkupplung für Zentralbefestigung Ø22mm
Einbautiefe nicht einstellbar, Maß X bei Bestellung angeben IP66, cUL_{us} Type 4X

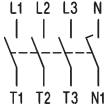
4-polig, Sperrvorrichtung SV4 ⚡⚡⚡⚡							
 	20A	7,5kW		64 □	LTS20 VZHN4 A4 X..	1	0,18
	25A	10kW		64 □	LTS25 VZHN4 A4 X..	1	0,18
	32A	12,5kW		64 □	LTS32 VZHN4 A4 X..	1	0,18
	40A	16kW		64 □	LTS40 VZHN4 A4 X..	1	0,18
	63A	22kW		64 □	LTS63 VZHN4 A4 X..	1	0,25
	80A	22kW		64 □	LTS80 VZHN4 A4 X..	1	0,25

Einbautiefe Maß X unbedingt angeben

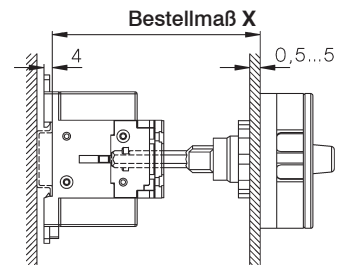

Typ	Vorzugswerte für X
LTS.. VZHN..	80, 85, 104, 129 (Toleranz -3, +1,5)







Zusatzmodule siehe Seite 297

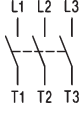

1) Auf Anfrage auch in Schildgröße 88 □ erhältlich Typenzusatz **88** z. B: LTS32 VHN**488** A3

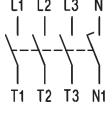
Hauptschalter-Not-Aus, für Reiheneinbau, absperrrbar IP40, Open Type

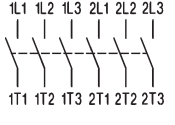

	max. Schlösser	AC21 690V	AC23 3x400V	Schild	Typ	VPE Stk.	Gewicht kg/Stk.	
3-polig, Sperrvorrichtung SV1 								
		20A	7,5kW	52x45	LTS20 SMAHN1 A3 ²⁾	1	0,15	
		25A	10kW	52x45	LTS25 SMAHN1 A3 ²⁾	1	0,15	
		32A	12,5kW	52x45	LTS32 SMAHN1 A3 ²⁾	1	0,15	
			40A	16kW	52x45	LTS40 SMAHN1 A3 ²⁾	1	0,15
			63A	22kW	52x45	LTS63 SMAHN1 A3 ²⁾	1	0,18
			80A	22kW	52x45	LTS80 SMAHN1 A3 ²⁾	1	0,18
			85A	30kW	78x45	LTS85 SMAHN1 A3	1	0,37
			100A	37kW	78x45	LTS100 SMAHN1 A3	1	0,37
		125A	45kW	78x45	LTS125 SMAHN1 A3	1	0,37	

4-polig, Sperrvorrichtung SV1 								
		20A	7,5kW	52x45	LTS20 SMAHN1 A4 ²⁾	1	0,16	
		25A	10kW	52x45	LTS25 SMAHN1 A4 ²⁾	1	0,16	
		32A	12,5kW	52x45	LTS32 SMAHN1 A4 ²⁾	1	0,16	
			40A	16kW	52x45	LTS40 SMAHN1 A4 ²⁾	1	0,16
			63A	22kW	52x45	LTS63 SMAHN1 A4 ²⁾	1	0,21
			80A	22kW	52x45	LTS80 SMAHN1 A4 ²⁾	1	0,21
			85A	30kW	78x45	LTS85 SMAHN1 A4	1	0,42
			100A	37kW	78x45	LTS100 SMAHN1 A4	1	0,42
		125A	45kW	78x45	LTS125 SMAHN1 A4	1	0,42	

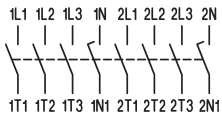
6-polig, Sperrvorrichtung SV1(64) 								
		20A	7,5kW	52x45	LTS20 SMAHN1 A6	1	0,29	
		25A	10kW	52x45	LTS25 SMAHN1 A6	1	0,29	
		32A	12,5kW	52x45	LTS32 SMAHN1 A6	1	0,29	
			40A	16kW	52x45	LTS40 SMAHN1 A6	1	0,29
			63A	22kW	97x45	LTS63 SMAHN1 A6 ¹⁾	1	0,34
			80A	22kW	97x45	LTS80 SMAHN1 A6 ¹⁾	1	0,34

8-polig, Sperrvorrichtung SV164 								
		20A	7,5kW	97x45	LTS20 SMAHN1 A8	1	0,31	
		25A	10kW	97x45	LTS25 SMAHN1 A8	1	0,31	
		32A	12,5kW	97x45	LTS32 SMAHN1 A8	1	0,31	
			40A	16kW	97x45	LTS40 SMAHN1 A8	1	0,31
			63A	22kW	126x45	LTS63 SMAHN1 A8	1	0,42
			80A	22kW	126x45	LTS80 SMAHN1 A8	1	0,42

Umschalter mit Sperrvorrichtung für Reiheneinbau, absperrrbar

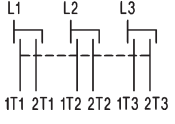
3-polig, Sperrvorrichtung SV164 								
		20A	7,5kW	97x45	LTS20 SMAHN1 U3	1	0,29	
		25A	10kW	97x45	LTS25 SMAHN1 U3	1	0,29	
		32A	12,5kW	97x45	LTS32 SMAHN1 U3	1	0,29	
			40A	16kW	97x45	LTS40 SMAHN1 U3	1	0,29
			63A	22kW	97x45	LTS63 SMAHN1 U3	1	0,34

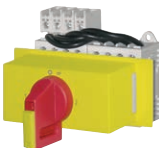
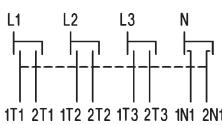







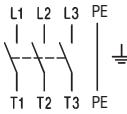

4-polig, Sperrvorrichtung SV164 								
		20A	7,5kW	97x45	LTS20 SMAHN1 U4	1	0,31	
		25A	10kW	97x45	LTS25 SMAHN1 U4	1	0,31	
		32A	12,5kW	97x45	LTS32 SMAHN1 U4	1	0,31	
			40A	16kW	97x45	LTS40 SMAHN1 U4	1	0,31
			63A	22kW	126x45	LTS63 SMAHN1 U4	1	0,42

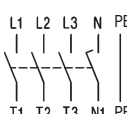
1) mit Sperrvorrichtung SV164

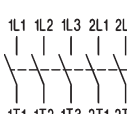
2) Hauptschalter-Not-Aus, für Reiheneinbau, absperrrbar mit **niedrigem Griff**, IP40

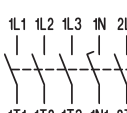

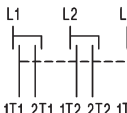

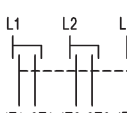



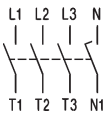

Typ mit Typenzusatz „+SV1N“ z.B.: **LTS40 SMAHN1 A3 +SV1N**

Reparaturschalter-Not-Aus isolierstoffgekapselt, absperrbar IP66, cUL_{us} Type 4X

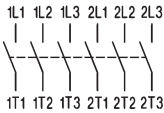

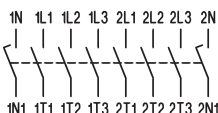
	max. Schlösser	AC21 690V	AC23 3x400V	Schild	Typ	VPE Stk.	Gewicht kg/Stk.	
3-polig, Sperrvorrichtung SV4(34)								
 		20A	7,5kW	64 [□]	LTS20 PF(L ¹)HN4 A3	1	0,32	
		25A	10kW	64 [□]	LTS25 PF(L ¹)HN4 A3	1	0,32	
		32A	12,5kW	64 [□]	LTS32 PF(L ¹)HN4 A3	1	0,32	
		40A	16kW	64 [□]	LTS40 PF(L ¹)HN4 A3	1	0,32	
		63A	22kW	64 [□]	LTS63 PFLHN4 A3	1	0,60	
		80A	22kW	64 [□]	LTS80 PFLHN4 A3	1	0,60	
		85A	30kW	64 [□]	LTS85 PFLHN4 A3	1	0,78	
		100A	37kW	64 [□]	LTS100 PFLHN4 A3	1	0,78	
	Größeres Gehäuse Typ: ..PFL..	auf Anfrage	125A	45kW	64 [□]	LTS125 PFLHN4 A3	1	0,78
		auf Anfrage	160A	55kW	88 [□]	LT160 PFHN34 T300	1	2,09
4-polig, Sperrvorrichtung SV4(34)								
 		20A	7,5kW	64 [□]	LTS20 PF(L ¹)HN4 A4	1	0,33	
		25A	10kW	64 [□]	LTS25 PF(L ¹)HN4 A4	1	0,33	
		32A	12,5kW	64 [□]	LTS32 PF(L ¹)HN4 A4	1	0,33	
		40A	16kW	64 [□]	LTS40 PF(L ¹)HN4 A4	1	0,33	
		63A	22kW	64 [□]	LTS63 PFLHN4 A4	1	0,64	
		80A	22kW	64 [□]	LTS80 PFLHN4 A4	1	0,64	
		85A	30kW	64 [□]	LTS85 PFLHN4 A4	1	0,83	
		100A	37kW	64 [□]	LTS100 PFLHN4 A4	1	0,83	
	Größeres Gehäuse Typenzusatz +PF3	auf Anfrage	125A	45kW	64 [□]	LTS125 PFLHN4 A4	1	0,83
	+PF3/M50	auf Anfrage	160A	55kW	88 [□]	LT160 PFHN34 T400	1	2,47
6-polig, Sperrvorrichtung SV4								
 		20A	7,5kW	64 [□]	LTS20 PFLHN4 A6	1	1,39	
		25A	10kW	64 [□]	LTS25 PFLHN4 A6	1	1,39	
		32A	12,5kW	64 [□]	LTS32 PFLHN4 A6	1	1,39	
		40A	16kW	64 [□]	LTS40 PFLHN4 A6	1	1,39	
		63A	22kW	64 [□]	LTS63 PFLHN4 A6	1	1,42	
		80A	22kW	64 [□]	LTS80 PFLHN4 A6	1	1,42	
	Anbauverschraubung M50/40							
	+PF3/M50	auf Anfrage						
	8-polig, Sperrvorrichtung SV4							
	 		20A	7,5kW	64 [□]	LTS20 PFLHN4 A8	1	1,44
		25A	10kW	64 [□]	LTS25 PFLHN4 A8	1	1,44	
		32A	12,5kW	64 [□]	LTS32 PFLHN4 A8	1	1,44	
		40A	16kW	64 [□]	LTS40 PFLHN4 A8	1	1,44	
		63A	22kW	64 [□]	LTS63 PFLHN4 A8	1	1,50	
		80A	22kW	64 [□]	LTS80 PFLHN4 A8	1	1,50	
Anbauverschraubung M50/40								
+PF3/M50		auf Anfrage						
Umschalter mit Sperrvorrichtung, absperrbar								
3-polig, Sperrvorrichtung SV4								
 		20A	7,5kW	64 [□]	LTS20 PFLHN4 U3	1	1,39	
		25A	10kW	64 [□]	LTS25 PFLHN4 U3	1	1,39	
		32A	12,5kW	64 [□]	LTS32 PFLHN4 U3	1	1,39	
		40A	16kW	64 [□]	LTS40 PFLHN4 U3	1	1,39	
		63A	22kW	64 [□]	LTS63 PFLHN4 U3	1	1,42	
		80A	22kW	64 [□]	LTS80 PFLHN4 U3	1	1,42	
4-polig, Sperrvorrichtung SV4								
 		20A	7,5kW	64 [□]	LTS20 PFLHN4 U4	1	1,44	
		25A	10kW	64 [□]	LTS25 PFLHN4 U4	1	1,44	
		32A	12,5kW	64 [□]	LTS32 PFLHN4 U4	1	1,44	
		40A	16kW	64 [□]	LTS40 PFLHN4 U4	1	1,44	
		63A	22kW	64 [□]	LTS63 PFLHN4 U4	1	1,50	
		80A	22kW	64 [□]	LTS80 PFLHN4 U4	1	1,50	

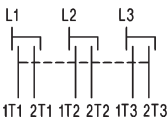
1) PFL.... größerer Anschlußraum

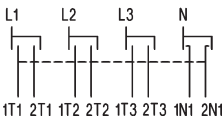



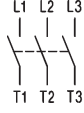

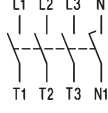
Lasttrennschalter für Einbau, IP66,  Type 3R

	AC21 690V	AC23 3x400V	Schild	Typ	VPE Stk.	Gewicht kg/Stk.
Ein-Ausschalter 3-polig						
 	20A	7,5kW	48 □	LTS20 E A3	1	0,15
	25A	10kW	48 □	LTS25 E A3	1	0,15
	32A	12,5kW	48 □	LTS32 E A3	1	0,15
	40A	16kW	48 □	LTS40 E A3	1	0,15
	63A	22kW	48 □	LTS63 E A3	1	0,17
	80A	22kW	48 □	LTS80 E A3	1	0,17
	85A	30kW	64 □	LTS85 E A3	1	0,39
	100A	37kW	64 □	LTS100 E A3	1	0,39
	125A	45kW	64 □	LTS125 E A3	1	0,39
	160A	55kW	88 □	LT160 E T300	1	1,10
Ein-Ausschalter 4-polig						
 	20A	7,5kW	48 □	LTS20 E A4	1	0,18
	25A	10kW	48 □	LTS25 E A4	1	0,18
	32A	12,5kW	48 □	LTS32 E A4	1	0,18
	40A	16kW	48 □	LTS40 E A4	1	0,18
	63A	22kW	48 □	LTS63 E A4	1	0,21
	80A	22kW	48 □	LTS80 E A4	1	0,21
	85A	30kW	64 □	LTS85 E A4	1	0,44
	100A	37kW	64 □	LTS100 E A4	1	0,44
	125A	45kW	64 □	LTS125 E A4	1	0,44
	160A	55kW	88 □	LT160 E T400	1	1,50
Ein-Ausschalter 6-polig						
 	20A	7,5kW	64 □	LTS20 E A6	1	0,30
	25A	10kW	64 □	LTS25 E A6	1	0,30
	32A	12,5kW	64 □	LTS32 E A6	1	0,30
	40A	16kW	64 □	LTS40 E A6	1	0,30
	63A	22kW	64 □	LTS63 E A6	1	0,36
	80A	22kW	64 □	LTS80 E A6	1	0,36
Ein-Ausschalter 8-polig						
 	20A	7,5kW	64 □	LTS20 E A8	1	0,32
	25A	10kW	64 □	LTS25 E A8	1	0,32
	32A	12,5kW	64 □	LTS32 E A8	1	0,32
	40A	16kW	64 □	LTS40 E A8	1	0,32
	63A	22kW	64 □	LTS63 E A8	1	0,43
	80A	22kW	64 □	LTS80 E A8	1	0,43
Umschalter 3-polig						
 	20A	7,5kW	64 □	LTS20 E U3	1	0,31
	25A	10kW	64 □	LTS25 E U3	1	0,31
	32A	12,5kW	64 □	LTS32 E U3	1	0,31
	40A	16kW	64 □	LTS40 E U3	1	0,31
	63A	22kW	64 □	LTS63 E U3	1	0,37
Umschalter 4-polig						
 	20A	7,5kW	64 □	LTS20 E U4	1	0,33
	25A	10kW	64 □	LTS25 E U4	1	0,33
	32A	12,5kW	64 □	LTS32 E U4	1	0,33
	40A	16kW	64 □	LTS40 E U4	1	0,33
	63A	22kW	64 □	LTS63 E U4	1	0,44

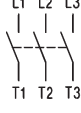
Lasttrennschalter für Zentralbefestigung, absperrrbar IP66,  Type 4X

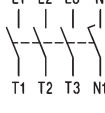
		max. Schlösser	AC21 690V	AC23 3x400V	Schild	Typ	VPE Stk.	Gewicht kg/Stk.
Ein-Ausschalter 3-polig								
 			20A	7,5kW	48 □	LTS20 Z A3	1	0,16
			25A	10kW	48 □	LTS25 Z A3	1	0,16
			32A	12,5kW	48 □	LTS32 Z A3	1	0,16
			40A	16kW	48 □	LTS40 Z A3	1	0,16
	Ein-Ausschalter 4-polig							
 			20A	7,5kW	48 □	LTS20 Z A4	1	0,20
			25A	10kW	48 □	LTS25 Z A4	1	0,20
			32A	12,5kW	48 □	LTS32 Z A4	1	0,20
			40A	16kW	48 □	LTS40 Z A4	1	0,20

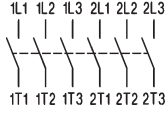
Lasttrennschalter, Bodenmontage mit Türkupplung für Zentralbefestigung Ø22mm
Einbautiefe nachträglich einstellbar (Lieferlänge, X_{max} siehe Seite 294) IP66,  Type 4X

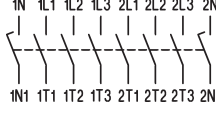
		max. Schlösser	AC21 690V	AC23 3x400V	Schild	Typ	VPE Stk.	Gewicht kg/Stk.
Ein-Ausschalter 3-polig								
 			20A	7,5kW	64 □	LTS20 VZV A3	1	0,19
			25A	10kW	64 □	LTS25 VZV A3	1	0,19
			32A	12,5kW	64 □	LTS32 VZV A3	1	0,19
			40A	16kW	64 □	LTS40 VZV A3	1	0,19
			63A	22kW	64 □	LTS63 VZV A3	1	0,22
			80A	22kW	64 □	LTS80 VZV A3	1	0,22
			85A	30kW	64 □	LTS85 VZV A3	1	0,40
			100A	37kW	64 □	LTS100 VZV A3	1	0,40
			125A	45kW	64 □	LTS125 VZV A3	1	0,40
	Ein-Ausschalter 4-polig							
 			20A	7,5kW	64 □	LTS20 VZV A4	1	0,20
			25A	10kW	64 □	LTS25 VZV A4	1	0,20
			32A	12,5kW	64 □	LTS32 VZV A4	1	0,20
			40A	16kW	64 □	LTS40 VZV A4	1	0,20
			63A	22kW	64 □	LTS63 VZV A4	1	0,26
			80A	22kW	64 □	LTS80 VZV A4	1	0,26
			85A	30kW	64 □	LTS85 VZV A4	1	0,45
			100A	37kW	64 □	LTS100 VZV A4	1	0,45
			125A	45kW	64 □	LTS125 VZV A4	1	0,45
	Ein-Ausschalter 6-polig							
 			20A	7,5kW	64 □	LTS20 VZV A6	1	0,32
			25A	10kW	64 □	LTS25 VZV A6	1	0,32
			32A	12,5kW	64 □	LTS32 VZV A6	1	0,32
			40A	16kW	64 □	LTS40 VZV A6	1	0,32
			63A	22kW	64 □	LTS63 VZV A6	1	0,37
			80A	22kW	64 □	LTS80 VZV A6	1	0,37
	Ein-Ausschalter 8-polig							
 			20A	7,5kW	64 □	LTS20 VZV A8	1	0,34
			25A	10kW	64 □	LTS25 VZV A8	1	0,34
			32A	12,5kW	64 □	LTS32 VZV A8	1	0,34
			40A	16kW	64 □	LTS40 VZV A8	1	0,34
			63A	22kW	64 □	LTS63 VZV A8	1	0,45
			80A	22kW	64 □	LTS80 VZV A8	1	0,45

Lasttrennschalter, Bodenmontage mit Türkupplung für Zentralbefestigung Ø22mm
 Einbautiefe nachträglich einstellbar (Lieferlänge, X_{max} siehe unten) IP66, cUL_{us} Type 4X

Einbautiefe
Zentralbefestigung Ø22mm
LTS.. VZV..

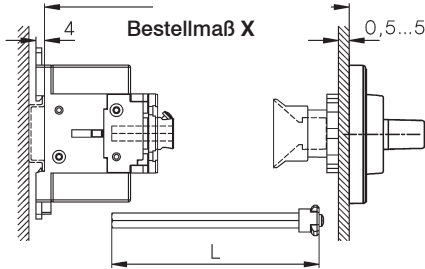

Typ		X min	X max	L
LTS20-80 VZV..	3, 4-polig	91 -	190	X - 40±3
LTS20-80 VZV..	6, 8-polig	111 -	190	X - 60±3
LTS85-125 VZV..	3, 4-polig	95-	190	X - 44±3

größere X- und T-Maße (max. 380mm für LTS..) auf Anfrage

4-Lochbefestigung
LTS.. V(HN).. (3, 4-polig)

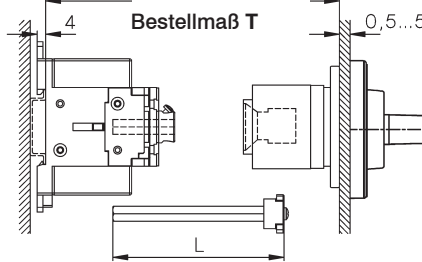

Typ		T min	T max	L	Typ	T min	T max
LTS20-80 V..		111 -	190	T - 60±3	LT160 V..		120 - 450
LTS85-125 V..		115 -	190	T - 64±3			

Lasttrennschalter, Bodenmontage mit Türkupplung für 4-Lochbefestigung
 Einbautiefe nachträglich einstellbar (Lieferlänge, T_{max} siehe oben) IP66, cUL_{us} Type 4X

	max. Schüssler	AC21 690V	AC23 3x400V	Schild	Typ	VPE Stk.	Gewicht kg/Stk.
Ein-Ausschalter 3-polig							
	20A	7,5kW	64 □ 1)	LTS20 V A3	1	0,20	
	25A	10kW	64 □ 1)	LTS25 V A3	1	0,20	
	32A	12,5kW	64 □ 1)	LTS32 V A3	1	0,20	
	40A	16kW	64 □ 1)	LTS40 V A3	1	0,20	
	63A	22kW	64 □ 1)	LTS63 V A3	1	0,24	
	80A	22kW	64 □ 1)	LTS80 V A3	1	0,24	
	85A	30kW	64 □ 1)	LTS85 V A3	1	0,40	
	100A	37kW	64 □ 1)	LTS100 V A3	1	0,40	
	125A	45kW	64 □ 1)	LTS125 V A3	1	0,40	
	160A	55kW	88 □	LT160 V T300	1	1,38	
Ein-Ausschalter 4-polig							
	20A	7,5kW	64 □ 1)	LTS20 V A4	1	0,21	
	25A	10kW	64 □ 1)	LTS25 V A4	1	0,21	
	32A	12,5kW	64 □ 1)	LTS32 V A4	1	0,21	
	40A	16kW	64 □ 1)	LTS40 V A4	1	0,21	
	63A	22kW	64 □ 1)	LTS63 V A4	1	0,28	
	80A	22kW	64 □ 1)	LTS80 V A4	1	0,28	
	85A	30kW	64 □ 1)	LTS85 V A4	1	0,45	
	100A	37kW	64 □ 1)	LTS100 V A4	1	0,45	
	125A	45kW	64 □ 1)	LTS125 V A4	1	0,45	
	160A	55kW	88 □	LT160 V T400	1	1,77	

Zusatzmodule siehe Seite 297

1) Auf Anfrage auch in Schildgröße 88 □ erhältlich Typenzusatz **88** z. B: LTS32 VHN488 A3

Lasttrennschalter, Bodenmontage mit Stecktürkupplung für Zentralbefestigung Ø22mm
 Einbautiefe nicht einstellbar, Maß X bei Bestellung angeben IP66,  Type 4X

	max. Schösser	AC21 690V	AC23 3x400V	Schild	Typ	VPE Stk.	Gewicht kg/Stk.
Ein-Ausschalter 4-polig 		20A	7,5kW	64 □	LTS20 VZ A4 X..	1	0,18
		25A	10kW	64 □	LTS25 VZ A4 X..	1	0,18
		32A	12,5kW	64 □	LTS32 VZ A4 X..	1	0,18
		40A	16kW	64 □	LTS40 VZ A4 X..	1	0,18
		63A	22kW	64 □	LTS63 VZ A4 X..	1	0,25
		80A	22kW	64 □	LTS80 VZ A4 X..	1	0,25

Einbautiefe Maß X unbedingt angeben

Typ	Vorzugsreihe für X
LTS.. VZ..	80, 85, 104, 129 (Toleranz -3, +1,5)

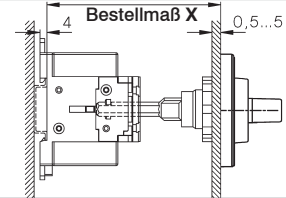



Zusatzmodule siehe Seite 297

Lasttrennschalter für Reiheneinbau IP40,  Open Type

Ein-Ausschalter 3-polig 							
	20A	7,5kW	52x45	LTS20 SMA A3	1	0,15	
	25A	10kW	52x45	LTS25 SMA A3	1	0,15	
	32A	12,5kW	52x45	LTS32 SMA A3	1	0,15	
	40A	16kW	52x45	LTS40 SMA A3	1	0,15	
	63A	22kW	52x45	LTS63 SMA A3	1	0,17	
	80A	22kW	52x45	LTS80 SMA A3	1	0,17	
	85A	30kW	78x45	LTS85 SMA A3	1	0,37	
	100A	37kW	78x45	LTS100 SMA A3	1	0,37	
	125A	45kW	78x45	LTS125 SMA A3	1	0,37	

Ein-Ausschalter 4-polig 							
	20A	7,5kW	52x45	LTS20 SMA A4	1	0,16	
	25A	10kW	52x45	LTS25 SMA A4	1	0,16	
	32A	12,5kW	52x45	LTS32 SMA A4	1	0,16	
	40A	16kW	52x45	LTS40 SMA A4	1	0,16	
	63A	22kW	52x45	LTS63 SMA A4	1	0,21	
	80A	22kW	52x45	LTS80 SMA A4	1	0,21	
	85A	30kW	78x45	LTS85 SMA A4	1	0,42	
	100A	37kW	78x45	LTS100 SMA A4	1	0,42	
	125A	45kW	78x45	LTS125 SMA A4	1	0,42	









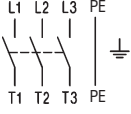

Ein-Ausschalter 6-polig 							
	20A	7,5kW	52x45	LTS20 SMA A6	1	0,29	
	25A	10kW	52x45	LTS25 SMA A6	1	0,29	
	32A	12,5kW	52x45	LTS32 SMA A6	1	0,29	
	40A	16kW	52x45	LTS40 SMA A6	1	0,29	
	63A	22kW	97x45	LTS63 SMA A6	1	0,34	
	80A	22kW	97x45	LTS80 SMA A6	1	0,34	

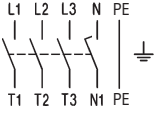
Ein-Ausschalter 8-polig 							
	20A	7,5kW	97x45	LTS20 SMA A8	1	0,31	
	25A	10kW	97x45	LTS25 SMA A8	1	0,31	
	32A	12,5kW	97x45	LTS32 SMA A8	1	0,31	
	40A	16kW	97x45	LTS40 SMA A8	1	0,31	
	63A	22kW	126x45	LTS63 SMA A8	1	0,42	
	80A	22kW	126x45	LTS80 SMA A8	1	0,42	

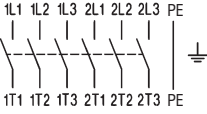

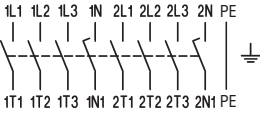

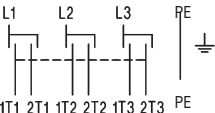

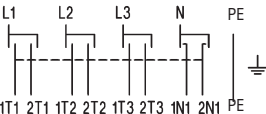



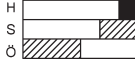

Umschalter 3-polig 							
	20A	7,5kW	97x45	LTS20 SMA U3	1	0,30	
	25A	10kW	97x45	LTS25 SMA U3	1	0,30	
	32A	12,5kW	97x45	LTS32 SMA U3	1	0,30	
	40A	16kW	97x45	LTS40 SMA U3	1	0,30	
	63A	22kW	97x45	LTS63 SMA U3	1	0,35	

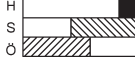
Umschalter 4-polig 							
	20A	7,5kW	97x45	LTS20 SMA U4	1	0,32	
	25A	10kW	97x45	LTS25 SMA U4	1	0,32	
	32A	12,5kW	97x45	LTS32 SMA U4	1	0,32	
	40A	16kW	97x45	LTS40 SMA U4	1	0,32	
	63A	22kW	126x45	LTS63 SMA U4	1	0,43	

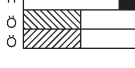
Lasttrennschalter isolierstoffgekapselt IP66, c(UL)us Type 4X

	AC21 690V	AC23 3x400V	Schild	Typ	VPE Stk.	Gewicht kg/Stk.
 	20A	7,5kW	64 □	LTS20 PF(L ¹) A3	1	0,30
	25A	10kW	64 □	LTS25 PF(L ¹) A3	1	0,30
	32A	12,5kW	64 □	LTS32 PF(L ¹) A3	1	0,30
	40A	16kW	64 □	LTS40 PF(L ¹) A3	1	0,30
	63A	22kW	64 □	LTS63 PFL A3	1	0,58
	80A	22kW	64 □	LTS80 PFL A3	1	0,58
	 	20A	7,5kW	64 □	LTS20 PF(L ¹) A4	1
25A		10kW	64 □	LTS25 PF(L ¹) A4	1	0,31
32A		12,5kW	64 □	LTS32 PF(L ¹) A4	1	0,31
40A		16kW	64 □	LTS40 PF(L ¹) A4	1	0,31
63A		22kW	64 □	LTS63 PFL A4	1	0,62
80A		22kW	64 □	LTS80 PFL A4	1	0,62
 		20A	7,5kW	64 □	LTS20 PFL A6	1
	25A	10kW	64 □	LTS25 PFL A6	1	1,39
	32A	12,5kW	64 □	LTS32 PFL A6	1	1,39
	40A	16kW	64 □	LTS40 PFL A6	1	1,39
	63A	22kW	64 □	LTS63 PFL A6	1	1,42
	80A	22kW	64 □	LTS80 PFL A6	1	1,42
	Anbauerschraubung M50/40 +PF3/M50 auf Anfrage					
 	20A	7,5kW	64 □	LTS20 PFL A8	1	1,44
	25A	10kW	64 □	LTS25 PFL A8	1	1,44
	32A	12,5kW	64 □	LTS32 PFL A8	1	1,44
	40A	16kW	64 □	LTS40 PFL A8	1	1,44
	63A	22kW	64 □	LTS63 PFL A8	1	1,50
	80A	22kW	64 □	LTS80 PFL A8	1	1,50
	Anbauerschraubung M50/40 +PF3/M50 auf Anfrage					
 	20A	7,5kW	64 □	LTS20 PFL U3	1	1,39
	25A	10kW	64 □	LTS25 PFL U3	1	1,39
	32A	12,5kW	64 □	LTS32 PFL U3	1	1,39
	40A	16kW	64 □	LTS40 PFL U3	1	1,39
	63A	22kW	64 □	LTS63 PFL U3	1	1,42
	80A	22kW	64 □	LTS80 PFL U3	1	1,42
	 	20A	7,5kW	64 □	LTS20 PFL U4	1
25A		10kW	64 □	LTS25 PFL U4	1	1,44
32A		12,5kW	64 □	LTS32 PFL U4	1	1,44
40A		16kW	64 □	LTS40 PFL U4	1	1,44
63A		22kW	64 □	LTS63 PFL U4	1	1,50
80A		22kW	64 □	LTS80 PFL U4	1	1,50















Zusatzmodule zum Anbau an Hauptschalter für Einbau und Zentralbefestigung

	für Schalter	Typ	VPE Stk.	Gewicht kg/Stk.	
	4.Pol für 3-polige Hauptschalter				
		LTS20 ... bis LTS40 ... LTS63 ... , LTS80 ...	N40E N80E	1 1	0,035 0,042
	Hilfskontaktblock 1S + 1Ö				
		LTS20 ... bis LTS125 ...	LH11	1	0,02
	Hilfskontaktblock 1S + 1Ö überlappend				
		LTS20 ... bis LTS125 ...	LH11X	1	0,02
	Hilfskontaktblock 2Ö				
		LTS20 ... bis LTS125 ...	LH20V/02E	1	0,02
	PE-Klemme				
		LTS20 ... bis LTS80 ... LT125 E.. bis LT160 E..	PE80E LTXX-E/E	1 1	0,04 0,2
	N-Klemme				
		LTS20 ... bis LTS80 ... LT125 E.. bis LT160 E..	PEN80E LTXX-N/E	1 1	0,04 0,2
	Klemmenabdeckung 3-polig				
		LTS20 ... bis LTS80 ... LTS85.. bis LTS125. LT125.. bis LT160..	KLAD70 KLAD125 XX-KLAD3	1 1 1	0,005 0,01 0,02
	Netzseitige Klemmenabdeckung für 4. Pol				
	Netzseitig Verbraucherseitig	LTS20 ... bis LTS80.. LTS20 ... bis LTS80..	KLAD70N KLAD70NI	1 1	0,002 0,002
	Klemmenabdeckung 4-polig				
		LTS85.. bis LTS125. LT125.. bis LT160..	KLAD125 XX-KLAD4	1 1	0,01 0,02

Zubehör zum Anbau an Hauptschalter für Einbau, Zentralbefestigung und Bodenmontage

	für Schalter	Typ	VPE Stk.	Gewicht kg/Stk.
	Zusatzschild gelb mit Aufschrift: HAUPTSCHALTER			
	für Schild 48' für Schild 64'	LTS.. .HN1.. LTS.. .HN4..	A91501 E91501	1 1
	Zusatzschild gelb mit Aufschrift: MAIN SWITCH			
	für Schild 48' für Schild 64'	LTS.. .HN1.. LTS.. .HN4..	A91524 E91524	1 1
	Flachsteckzunge 6,3 x 0,8mm für nachträglichen Anbau			
		LTS20 ... bis LTS40 ...	LG11073	10

Zusatzmodule zum Anbau an Hauptschalter für Bodenmontage und Reiheneinbau

	für Schalter		Typ	VPE Stk.	Gewicht kg/Stk.
	4.Pol für 3-polige Hauptschalter		LTS20 ... , LTS40 ...	N40V	1 0,035
			LTS63 ... , LTS80 ...	N80V	1 0,042
	Hilfskontaktblock 1S + 1Ö		LTS20 ... bis LTS125 ...	LH11	1 0,02
	Hilfskontaktblock 1S + 1Ö überlappend		LTS20 ... bis LTS125 ...	LH11X	1 0,02
	Hilfskontaktblock 2S		LTS20 ... bis LTS80 ...	LH20V/02E	1 0,02
	PE-Klemme		LTS20 ... bis LTS80 ...	PE80V	1 0,04
			LT125 .. bis LT160 ..	LTXE/V	1 0,2
	N-Klemme		LTS20 ... bis LTS80 ...	PEN80V	1 0,04
			LT125 .. bis LT160 ..	LTXN/V	1 0,2
	Klemmenabdeckung 3-polig		LTS20 ... bis LTS40 ...	KLAD40	1 0,005
			LTS63 ... bis LTS80 ...	KLAD70	1 0,005
			LTS85.. bis LTS125.	KLAD125	1 0,01
			LT125.. bis LT160..	XX-KLAD3	1 0,02
	Netzseitige Klemmenabdeckung für 4. Pol		Netzseitig LTS63.., LTS80..	KLAD70N	1 0,002
			Verbraucherseitig LTS63.., LTS80..	KLAD70NI	1 0,002
	Klemmenabdeckung 4-polig		LTS20 ... bis LTS40 ...	KLAD40	1 0,005
			LTS85.. bis LTS125.	KLAD125	1 0,01
			LT125.. bis LT160..	XX-KLAD4	1 0,02
	Zusatzabdeckung SMA für		4. Pol N40V, N80V	grau LG8628-2	1 0,047
			Hilfskontakt LH..	gelb LG8628-7	1 0,047
			PE und N-Klemme PE80V, PEN80V		

Technische Daten

Daten nach IEC 947-3, IEC 947-5-1, VDE 0660, EN 60947-3, EN 60947-5-1

Typ		LTS20	LTS25	LTS32	LTS40	LTS63	LTS80	LTS85	LTS100	LTS125	LT160	
Hauptkontakte												
Thermischer Bemessungsbetriebsstrom I_{th} offen	A	20	25	32	40	63	80	85	100	125	160	
Therm. Bemessungsbetriebsstrom I_{the} gekapselt	A	20	25	32	40	63	80	85	100	110	160	
Bemessungsisolationsspannung U_i ¹⁾	V	690	690	690	690	690	690	1000 ⁵⁾	1000 ⁵⁾	1000 ⁵⁾	1000 ³⁾	
Bemessungsbetriebsstrom I_e AC21A	A	20	25	32	40	63	80	85	100	125	160	
Einschaltvermögen I_{eff} 3x380-440V	A	160	190	220	300	370	440	600	725	850	1050	
Ausschaltvermögen	3x220-240V	A	160	180	200	250	330	380	480	580	680	900
	3x380-440V	A	160	180	200	250	330	380	480	580	680	850
	3x660-690V	A	80	110	140	170	190	220	250	330	420	340
Trennerbedingungen erfüllt bis	V	690	690	690	690	690	690	1000	1000	1000	1000 ³⁾	
Motorschalter AC3 3x400V	A	12	16	23	30	37	37	45	60	72	85	
Motorschalter für betriebsmäßiges Schalten	AC3 3x220-240V	kW	3	4	5,5	7,5	11	11	15	18,5	22	30
	3x380-440V	kW	5,5	7,5	11	15	18,5	18,5	22	30	37	45
	3x660-690V	kW	5,5	7,5	11	15	18,5	18,5	22	30	37	
Hauptschalter AC23 3x400V	A	16	20	25	32	45	45	60	72	85	110	
Motorschalter, AC23A, 3x220-240V	kW	4	5,5	7,5	9	15	15	18,5	22	30	30	
Hauptschalter, AC23B 3x380-440V	kW	7,5	10	12,5	16	22	22	30	37	45	55	
Reparaturschalter 3x660-690V	kW	5,5	7,5	11	15	18,5	18,5	22	30	37	37	
Bedingter Bemessungskurzschlußstrom kA_{eff}		10	10	10	10	10	10	10	10	5	30	
Maximale Vorsicherung gL (gG)	A	25	35	40	40	63	80	100	100	125	160	
Mechanische Lebensdauer $x10^3$		200	200	200	200	100	100	100	100	100	100	
Bemessungskurzzeitstromfestigkeit (1s-Strom)	A	250	300	400	500	600	850	1000	1200	1500	3000	
Verlustleistung pro Pol bei AC21 = I_{th} P/Pol [W]	E, Z	0,322	0,503	0,824	1,288	2,739	4,416	3,851	5,330	8,328		
	V, SMA, PF	0,364	0,569	0,933	1,458	2,739	4,416	3,851	5,330	8,328		
	E, Z	0,805	0,805	0,805	0,805	0,690	0,690	0,533	0,533	0,533		
	V, SMA, PF	0,911	0,911	0,911	0,911	0,690	0,690	0,533	0,533	0,533		
Zulässige Umgebungstemperatur												
Betrieb	offen	-40°C bis +60°C										
	gekapselt	-40°C bis +40°C										
Lagerung		-50°C bis +90°C										
Anschlußquerschnitte	mm ²	0,5 - 10				1 - 25 ⁶⁾		4 - 50		max.95		
ein- oder mehrdrähtig	AWG	20 - 8 (10)				16 - 4 (10)		12 - 00 (10)		max.3/0		
feindrähtig	mm ²	0,5 - 6				4 - 16 ⁶⁾		10 - 35		max.70		
	AWG	20 - 10				16 - 6		8 - 2		max.2/0		
feindrähtig mit Aderendhülse	mm ²	0,5 - 6				0,75 - 16 ⁶⁾		6 - 35		max.50		
	AWG	20 - 10				16 - 6		8 - 2		max.1/0		
Klemmschraube		M3,5				M5		M6		M10		
Anzugsdrehmoment	Nm	1,7 - 2,3				2,8 - 4		1,7 - 4,5		14		
Hilfskontakte												
Bemessungsisolationsspannung U_i ¹⁾	V	690				690		690		690		
Thermischer Bemessungsbetriebsstrom I_{th} , I_{the}	A	10				10		10		16		
Schaltvermögen	AC15 380-450V	2,5/1,5				2,5/1,5		2,5/1,5		6/4		
	DC13 60-110V	2/0,4				2/0,4		2/0,4		-		
Bedingter Bemessungskurzschlußstrom kA_{eff}		3				3		3		3		
Maximale Vorsicherung gL (gG)	A	10				10		10		16		
Anschlußquerschnitte	mm ²	0,75 - 2,5				0,75 - 2,5		0,75 - 2,5		max.4		
ein- oder mehrdrähtig	AWG	14 - 12				14 - 12		14 - 12		max.12		
feindrähtig (+ Aderendhülse)	mm ²	0,75 - 2,5 (1,5)				0,75 - 2,5 (1,5)		0,75 - 2,5 (1,5)		max.2,5		
	AWG	18 - 14				18 - 14		18 - 14		max.14		
Daten nach UL und cUL												
Typ		LTS20	LTS25	LTS32	LTS40	LTS63	LTS80	LTS85	LTS100	LTS125	LT160	
Bemessungsbetriebsspannung	V	600	600	600	600	600	600	600	600	600	600	
Ampere-Rating "General use"	A	20	25	32	40	63	80	85	100	125	200	
DOL-Rating 3-phase	110-120V	HP	1	1,5	2	2	3	5	7,5	10	15	20
	220-240V	HP	3	5	5	5	10	10	20	25	30	40
	440-480V	HP	7,5	10	10	10	20	20	40	50	60	60
	550-600V	HP	10	10	15	15	25	25	50	60	60	60
DOL-Rating 1-phase	110-120V	HP	1	1	1	1	2	2	3	5	7,5	-
	200-208V	HP	1	2	2	2	3	3	7,5	10	10	-
	220-240V	HP	2	2	3	3	5	5	10	15	15	-
Fuse size (RK5)	Manual Motor Controller	A	40	50	50	70	90	110	125	125	125	400 ⁴⁾
5kA / 600V	Motor Disconnect	A	40	50	50	50	70	70	125	125	125	400 ⁴⁾
Tightening torque	Nm	1,7-2,3	1,7-2,3	1,7-2,3	1,7-2,3	2,8-4	2,8-4	1,7-4,5	1,7-4,5	1,7-4,5	14	
	lb.inch	15-20	15-20	15-20	15-20	25-35	25-35	15-40	15-40	15-40	124	

1) gilt für: Netze mit geerdetem Sternpunkt, Überspannungskategorie I bis III, Verschmutzungsgrad 3 (Norm-Industrie): $U_{imp} = 6kV$.

2) der kleinere Wert gilt für 6-polige Schalter

3) Bei Spannungen über 690V~ nur Schalten ohne Last (AC20A)

4) Fuse RK1 / 10kA / 600V

5) $U_{imp} = 8kV$

6) LTS63..U. mehrdrähtig 16mm², feindrähtig 10mm²

Maße in mm

Hauptschalter, Lasttrennschalter LT(S)..

Einbau LT.. E(HN)..
Ein-Aus-Schalter 3-polig, 4-polig

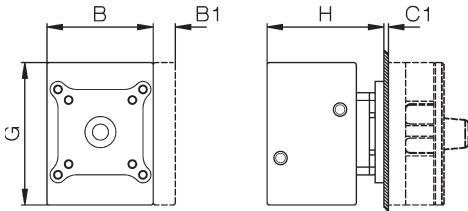

Ein-Aus-Schalter 6-polig, 8-polig
Umschalter 3-polig, 4-polig

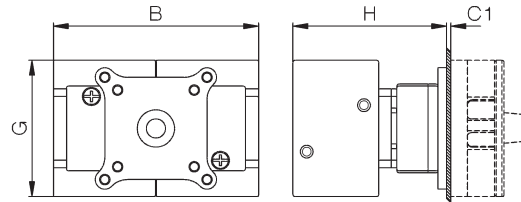

Bohrplan

Montageschraube: J3631N M=1,2-1,4 Nm

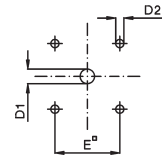

Zentralbefestigung LTS.. Z(HN)..
Ein-Aus-Schalter 3-polig, 4-polig

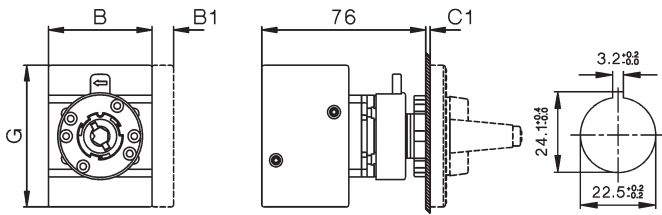

Bohrplan

Montage der Zusatzmodule LTS20 - LTS80
Einbau, Zentralbefestigung

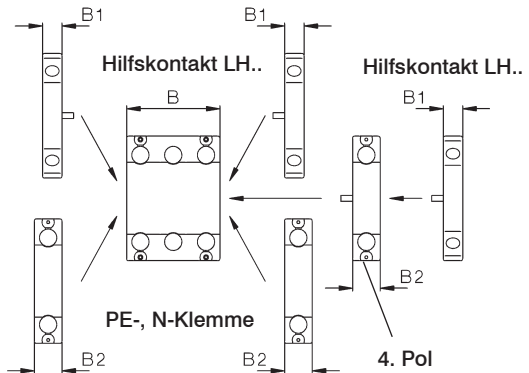

Typ	Umschalter Ausschalter Schild oder Sperrvorrichtung	3-polig		4-polig		Hilfs- kontakte B1	4.Pol			3,4-polig			3-polig		6-polig	
		A	B	B	B		B	PE B2	C1	D1	D2	E	F	G	H	H
LTS20-80..	48 □, SV1	48	48	62,5	-	-	10	14,5	1-5	9	5	36	-	64	54	-
LTS20-80..	64 □, SV4, SV164	64	48	62,5	97	126	10	14,5	1-5	9	5	48	-	64	54	74
LTS85-125..	64 □, SV4	64	78	78	-	-	10	-	1-5	9	5	48	-	85	60	-
LTS85-125..	88 □, SV488	88	78	78	-	-	10	-	1-5	9	6	68	-	85	60	-
LT160	88 □, SV34	88	112	150	224	-	-	-	1-4	13-17	6	68	49,3	108	96	98

Schild
48 □

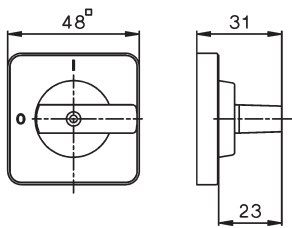

Sperrvorrichtungen
SV1

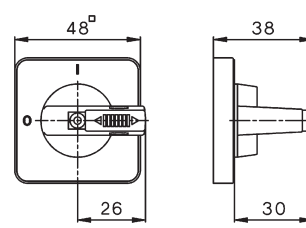

SV164

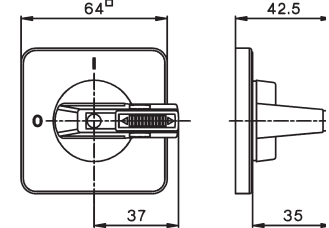

Sperrvorrichtungen
SV4

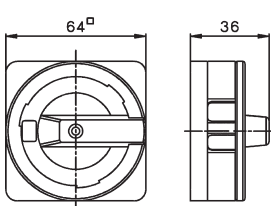

SV488

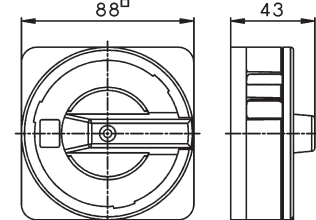

SV34

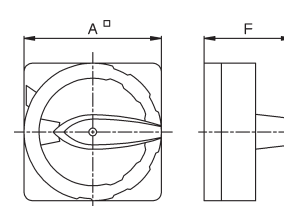

Verlängerte Schalterwelle
+VW"x"

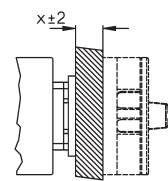

Maße in mm

Hauptschalter, Lasttrennschalter LT(S)..

Bodenmontage LTS.. VZV(HN)..

Ein-Aus-Schalter 3-polig, 4-polig

L = X - 40 ± 3 für LTS20 - 80

L = X - 44 ± 3 für LTS85 - 125

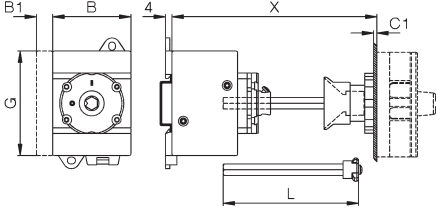

6-polig
nur für LTS20 - 40
L = X - 40 ± 3

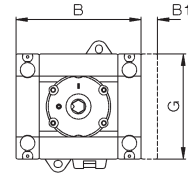

Ein-Aus-Schalter 6-polig, 8-polig
Umschalter 3-polig, 4-polig
L = X - 60 ± 3

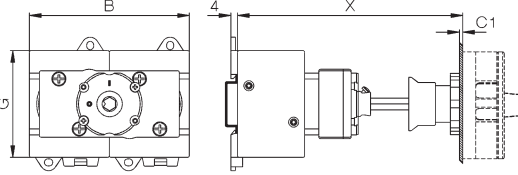

Bohrplan

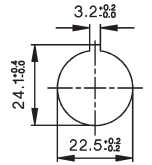

Bodenmontage LT(S).. V(HN)..

Ein-Aus-Schalter 3-polig, 4-polig

L = T - 60 ± 3 für LTS20 - 80

L = T - 64 ± 3 für LTS85 - 125

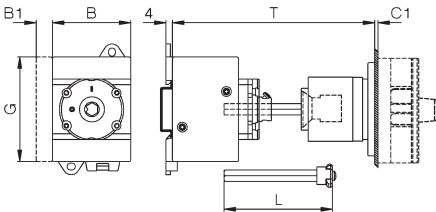

6-polig
nur für LTS20 - 40
L = T - 60 ± 3

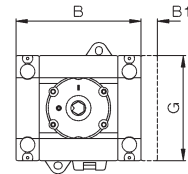

Ein-Aus-Schalter 6-polig, 8-polig
Umschalter 3-polig, 4-polig
L = T - 80 ± 3 gilt nur für Schalter LTS..

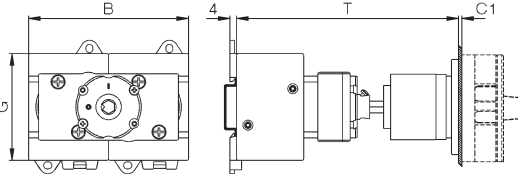

Bohrplan

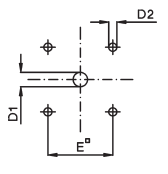

Bodenmontage LTS.. VZ(HN)..

Ein-Aus-Schalter 3-polig, 4-polig

Vorzugswerte für X: 80, 85, 104, 129

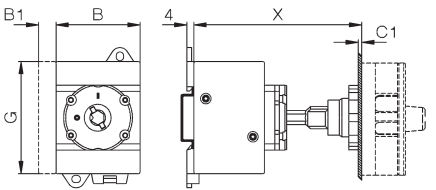

6-polig
nur für LTS20 - 40

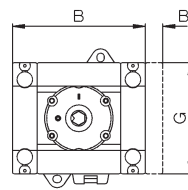

Ein-Aus-Schalter 6-polig, 8-polig
Umschalter 3-polig, 4-polig

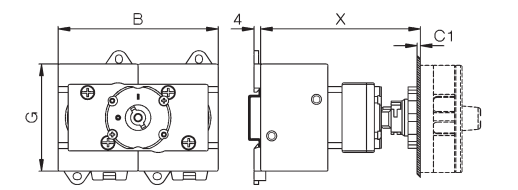

Bohrplan

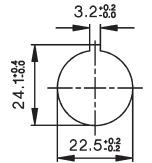

Typ	Umschalter Ausschalter Schild oder Sperrvorrichtung	3,4-polig					Hilfs- kontakte B1	4. Pol PE B2	C1	D1	D2	D3	E	G	K	K1	J
		3-polig	4-polig	6-polig	8-polig	B											
LTS20 - 40	64 □, SV4, SV164	64	48	48	77	97	10	14,5	1-5	9	5	M4	48	64	25	48	70
LTS63, 80	64 □, SV4, SV164	64	48	62,5	97	126	10	14,5	1-5	9	5	M4	48	64	25	48	70
LTS85-125..	64 □, SV4	64	78	78	-	-	10	-	1-5	9	5	M4	48	85	38	-	90
LT125/160	88 □, SV34	88	112	150	224	-	-	-	1-4	13/27 ²⁾	6	M6	68	108	36	-	120

**Bodenmontage
Ein-Aus-Schalter LTS20 - LTS80**

3-polig, 4-polig
6-polig LTS20 - 40

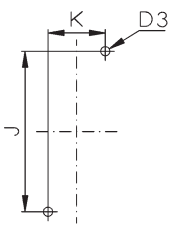

6-polig, 8-polig
Umschalter

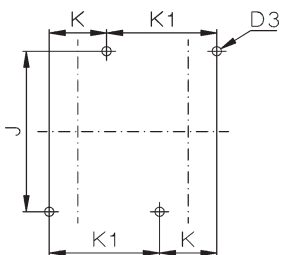

**LTS85-125, LT160
3-polig, 4-polig**

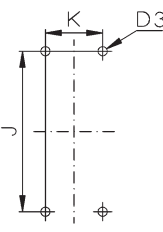

**Montage der Zusatzmodule LTS20 - LTS80
Bodenmontage, Reiheneinbau**

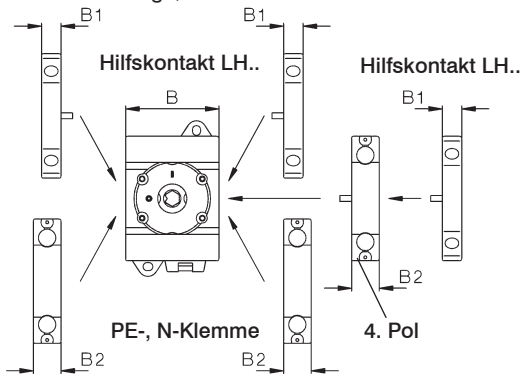

1) Ø 22-25 nur für LT80(100) VH(N)34 ..
2) Ø 26-30 nur für LT125(160) VH(N)34 ..

Maße in mm

Hauptschalter, Lasttrennschalter LT(S)..

Reiheneinbau LT(S).. SMA(HN)..

Ein-Aus-Schalter 3-polig, 4-polig

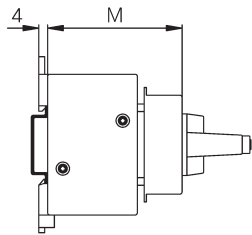
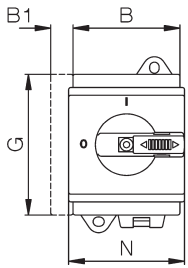

Ein-Aus-Schalter 6-polig
nur für LTS20 - LTS40

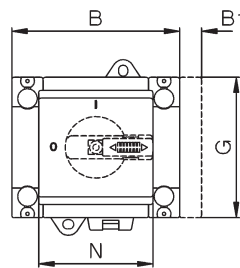

Ein-Aus-Schalter 6-polig, 8-polig
Umschalter 3-polig, 4-polig

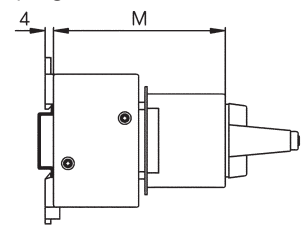
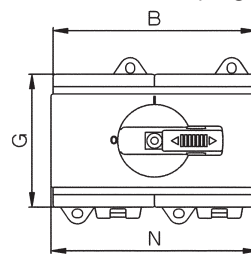

Typ	Sperrvorrichtung	Umschalter						G	3,4-polig			3,4-polig		
		Ausschalter	3-polig	4-polig	6-polig	8-polig	Hilfs- kontakte		4.Pol PE	3-polig 4-polig	6-polig	8-polig	3-polig 4-polig	6-polig
		B	B	B	B	B1	B2		M	M	M	N	N	N
LTS20 - 40	SV1, SV164	48	48	77	96	10	14,5	64	60	60	74	52	52	97 ²⁾
LTS63, 80	SV1, SV164	48	62,5	96	125	10	14,5	64	60	74	74	52	97 ²⁾	126 ¹⁾
LTS85-125..	SV164	78	78	-	-	10	-	85	60	-	-	78	-	-

Reiheneinbau mit niedrigem Griff LTS SMAHN1.. +SV1N

Hauptschalter 3-polig, 4-polig LTS20 - LTS80

Sperrvorrichtung SV1

Sperrvorrichtung SV164

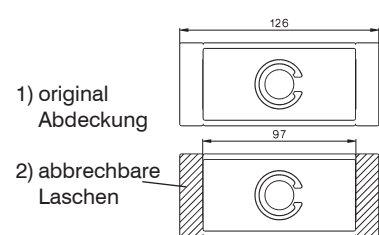
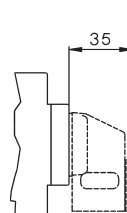
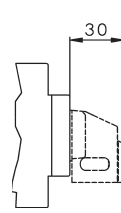
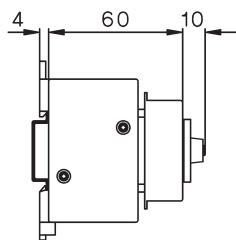
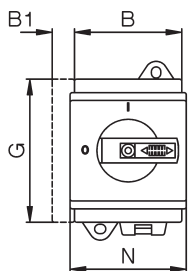

Reparaturschalter isolierstoffgekapselt LT(S)..PF..

Typ	Pole	Größe	A	B	C	D1	D2	E	F	H
LTS20 PFH.. A. - LTS40 PFH.. A. ³⁾	3, 4	PF1	130	98	120	2x25,5/20,5	-	75	100	76
LTS20 PFLH.. A., LTS40 PFLH A. ³⁾	3, 4	PFL	180	98	170	2x25,5/20,5 / 16,5/12,5-	-	75	150	76
LTS20 PFLH.. A. - LTS40 PFLH.. A. ⁴⁾	6	PFL2	200	140	188,5	40,5/32,5+16,5+12,5 -	-	100	160	86
LTS63 PFLH.. A. - LTS80 PFLH.. A. ⁴⁾	3, 4	PFL2	200	140	188,5	40,5/32,5+16,5+12,5 -	-	100	160	86
+ PF3	3, 4	PFL3	240	176	228,5	2x40,5/32,5	-	120	200	120
+ PF3/M50	3, 4	PFL3	240	176	228,5	50,5/40,5	-	120	200	120
LTS85 PFLH.. A. - LTS125 PFLH..A. ⁴⁾	3, 4	PFL2	200	140	188,5	40,5/32,5+16,5+12,5 -	-	100	160	86
LTS20 PFLH.. A. - LTS40 PFLH.. A. ⁵⁾	8	PFL3	240	176	228,5	2x40,5/32,5	-	120	200	120
LTS63 PFLH.. A. - LTS80 PFLH.. A. ⁵⁾	6, 8	PFL3	240	176	228,5	2x40,5/32,5	-	120	200	120
LTS85 PFLH.. A. - LTS125 PFLH..A. ⁵⁾	3, 4	PFL3	240	176	228,5	50,5/40,5	-	120	200	120
LT160 PF..	3	PF4	300	200	-	2x50,5	25,5	172	272	172
LT160 PF..	4	PF5	300	280	-	2x50,5	-	254	254	180

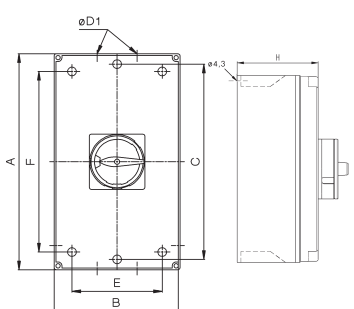

Lasttrennschalter isolierstoffgekapselt LTS..PF..

Typ	Pole	Größe	A	B	C	D1	E	F	H
LTS20 PF A., LTS40 PF A. ³⁾	3, 4	PF1	130	98	121	2x25,5/20,5	75	100	76
LTS20 PFL A., LTS40 PFL A. ³⁾	3, 4	PFL	180	98	170	2x25,5/20,5 / 16,5/12,5	75	150	76
LTS63 PFL A., LTS80 PFL A. ⁴⁾	3, 4	PFL2	200	140	188,5	40,5/32,5+16,5+12,5	100	160	86
+ PF3	3, 4	PFL3	240	176	228,5	2x40,5/32,5	120	200	120
+ PF3/M50	3, 4	PFL3	240	176	228,5	50,5/40,5	120	200	120

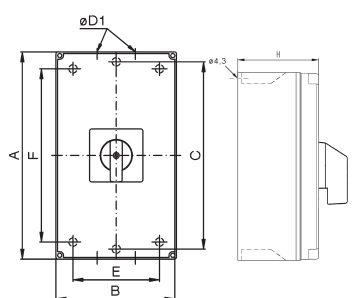

Maximale Bestückung in diesem Gehäuse

3) LTS40 PF. A5 + LH11

4) LTS40 PFL.. A6, LTS80 PFL.. A5 + LH11, LTS125 PFL.. A4 + LH11

5) LTS40 PFL.. A10, LTS40 PFL.. U4 + LH11, LTS80 PFL.. A8, LTS80 PFL..; A6 + LH11, LTS80 PFL.. U4, LTS40 PFL.. U3 + LH11; LTS125 PFL.. A4+LH11