

# Mini DC - Isolators for Photovoltaic

acc. to IEC 60364-7-712

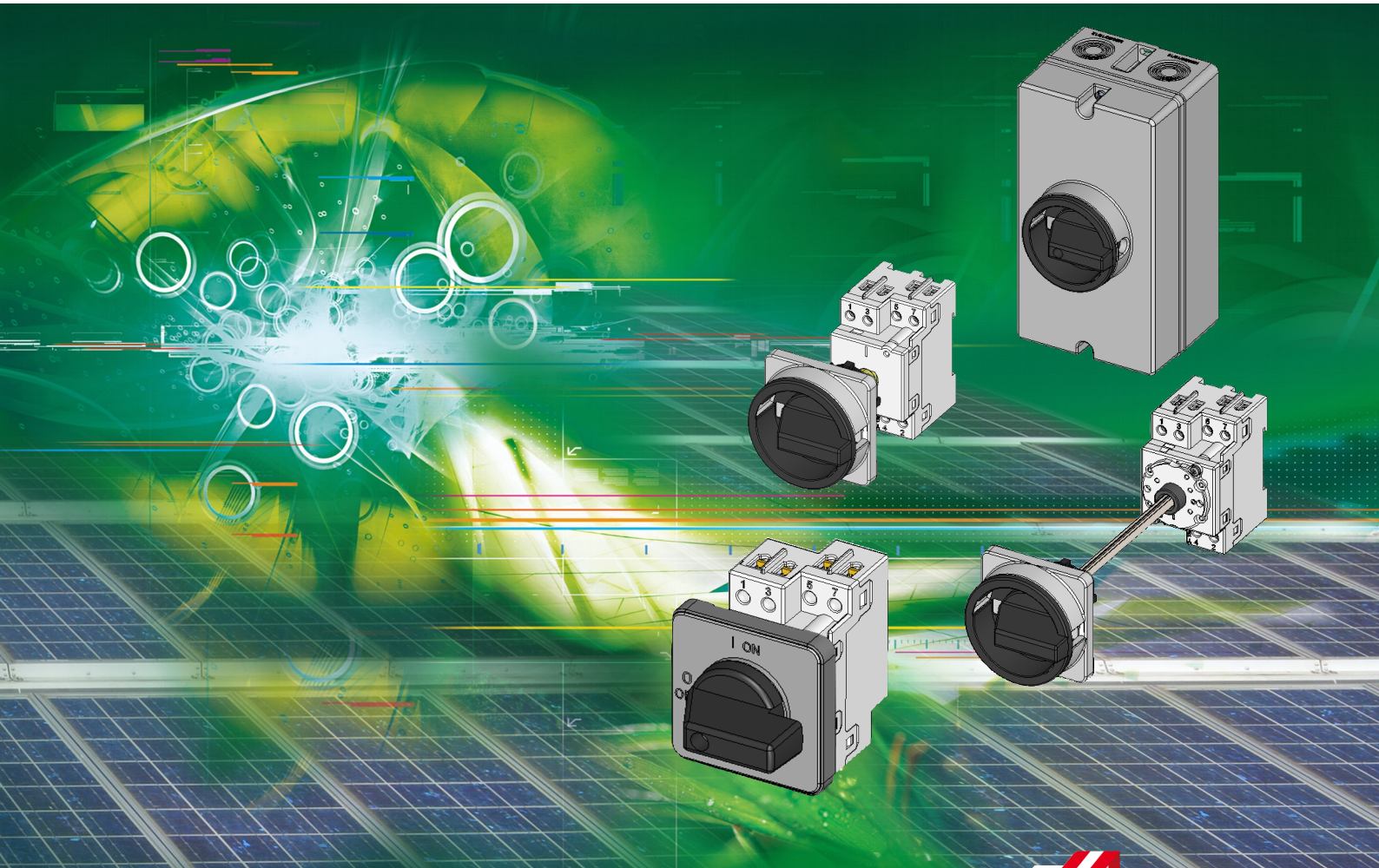

Quality made in 

D1024E171



**Contactors  
Motor-Starters**

Mini-Contactors  
Contactors  
Overload Relays  
Compacitor Switching Contactors  
Motor-Starters  
Modular Contactors

Catalogue **D677E..**



**Circuit  
Breakers**

M4-32T.. up to 32A  
M4-32R.. up to 32A  
M4-63R.. up to 63A  
M4-100R.. up to 100A

Catalogue **D795E..**



**Switches**

On-Off-Switches  
Changeover Switches  
Motor Switches  
Step Switches  
Main Switches  
Modular Switches  
Key Operated Switches

Catalogue **D371E..**



**Main  
Switches**

Emergency Off  
Main Switches  
On-Off-Switches  
Add-On-Module

Catalogue **D656E..**



**Capacitor Switching  
Contactors**

Contactors for reactive and non reactive capacitor banks

Catalogue **D385E..**

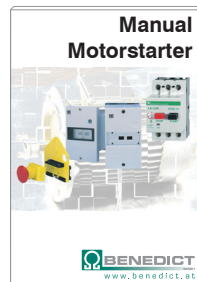

**Manual  
Motorstarter**

MU25A up to 32A  
Auxiliary Contact Blocks  
Trip Alarm Auxiliary Switches  
Busbar Connectors  
Enclosure

Catalogue **D509E..**



**Push Buttons**

Push Buttons  
Emergency Stop  
Key Operated Rotary Switches  
Rotary Knobs  
Illuminated Push Buttons  
Assembled Stations

Catalogue **D580E..**

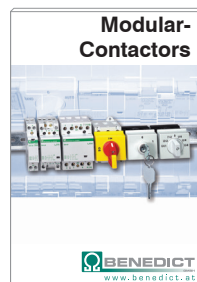

**Modular-  
Contactors**

Modular Contactors  
Accessories  
Emergency Off Switches  
Main Switches  
On-Off Switches  
Control Switches

Catalogue **D681E..**

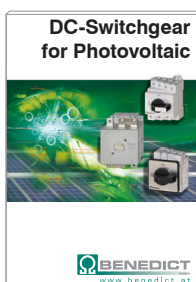

**DC-Switchgear  
for Photovoltaic**

Main Switches  
On-Off-Switches  
Contactors for DC-Switching

Catalogue **D911E..**



**Low Voltage  
Control Gear**

Contactors  
D.O.L. Starter  
Overload Relays  
Manual Motor Starter  
Main Switches  
Cam Switches  
Push Buttons  
Emergency Stop

Catalogue **D651E..**



## Ratings

### Rated Current

Type	$I_{th}$ open A	DC21B(DC-PV1) 4 poles in series A	at $U_e$ V
LSM16	16	16	1000
LSM25	25	25	1000

## Mini DC-Switch Disconnectors

Design	Panel mounting Four hole mounting IP66 <sup>1)</sup>	Panel mounting Two hole mounting IP66 <sup>1)</sup>	Single hole with door coupling Ø22,5mm, IP66 <sup>1)</sup>	Single hole with door coupling Ø16mm, IP66 <sup>1)</sup>

LSM16	16	16	1000	..E, EH4..	..E2, E2H1..	..Z(O), ZH1..	..Z16, Z16H4..
LSM25	25	25	1000	..E, EH4..	..E2, E2H1..	..Z(O), ZH1..	..Z16, Z16H4..

## Mini Switch Disconnectors for Photovoltaic

Mini Switch Disconnectors „LSM“ are switch gears for interrupting the DC/AC-Inverter from solar-panels. Photovoltaic-Installations have to be equipped with DC-Isolators acc. to IEC 60364-7-712.

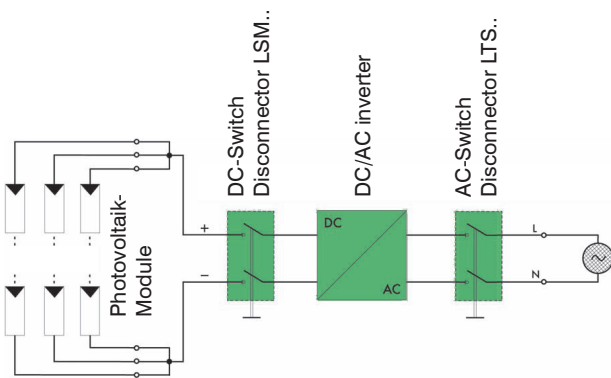

Mini Switch Disconnectors LSM ensure a reliable switching up to 25A at 1500V in the category DC21B (DC-PV1).

The construction of the contacts and the material selection guarantee that no oxidations develop (because of small switching frequency) and further it is prevented that inadmissible heating-up is effected.

Mini Switch Disconnectors LSM are equipped with 2 or 4 switchable, singular contacts. By serial or parallel wiring of the contacts the contact rating will be increased.

The switching speed by the manually driven handle does not have an effect on the switching attitude of the contacts.

## Switching programs

Type	2-pole	2+2-pole 2 poles in series + 2 Pole parallel	4-pole	4-pole with jumpers Input on top Output bottom	4-pole 2 jumpers top Input and Output bottom	4-pole 2 jumpers bottom Input and Output top
LSM16	.. A2	.. A2+2	.. A4(2 x A2)	.. A4B	.. A4O	.. A4U
LSM25	.. A2	.. A2+2	.. A4(2 x A2)	.. A4B	.. A4O	.. A4U

Contact  
Wiring diagram

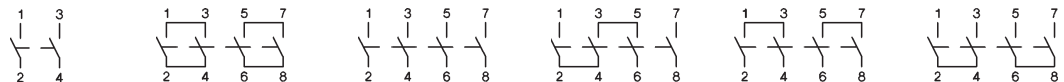

Switching example

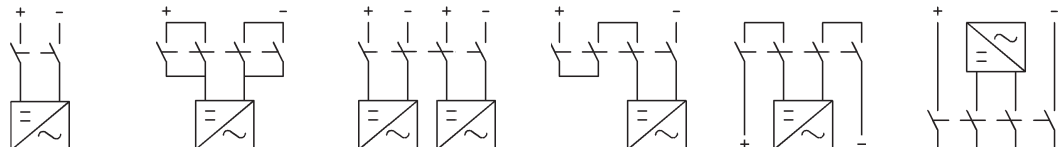

## Ordering

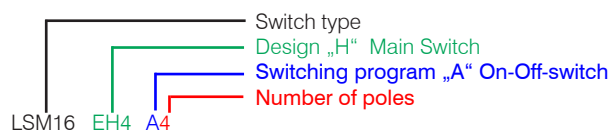

1) Protection in front and built in

## Mini DC-Switch Disconnectors

Base mounting with door coupling, single hole, Ø22,5mm, IP66<sup>1)</sup>



Modular Switch IP40<sup>1)</sup>

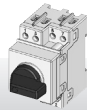

Plastic enclosed PFL..IP67<sup>1)</sup>



..VZV, VZVH4..  
..VZV, VZVH4..

..SMA, SMAH1..  
..SMA, SMAH1..

..PFLH4..  
..PFLH4..

### Technical data for DC, according to IEC 60947-3, VDE0660

Typ	Diagram	Type	DC21A/B (DC-PV1)								DC22B			
			500V	600V	700V	800V	900V	1000V	1200V	1500V	500V	600V	800V	1000V
2 Pole in Serie		<b>LSM16..</b> <b>LSM25..</b>	16A 25A	16A 25A	16A 25A	16A 19A	16A 17A	10A 11,5A	7A 8,5A	3A 5A	7A 8A	5,5A 6A	2A 2,5A	1A 1,5A
2 Pole in Serie + 2 parallel		<b>LSM16..</b> <b>LSM25..</b>	29A 45A	29A 36A	22A 27A	17A 19A	16A 17A	10A 12A	7A 9A	3A 5A	-	-	-	-
4 Pole in Serie		<b>LSM16..</b> <b>LSM25..</b>	16A 25A	16A 25A	16A 25A	16A 25A	16A 25A	16A 25A	16A 25A	16A 25A	16A 25A	16A 25A	11,5A 12A	8A 9A

**Isolated jumper LSMV..** for series and parallel switching of contacts (terminals 1-3, 5-7, 2-4, 6-8)

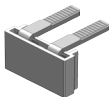





Type	Pack	Weight
<b>LSM16, LSM25</b>	<b>LSMV-B1</b>	100
		6,0 g/pc.

1) Protection in front and built in

# Technical Data

Kind of current	Category	Typical applications	Test conditions for the number of on-load operating cycles (normal service)						Test conditions for making and breaking capacities (operation in fault case)								
			Make		Break		L/R		Make		Break		L/R				
			I/le	U/Ue	L/R	Ic/le	Ur/Ue	L/R	I/le	U/Ue	L/R	Ic/le	Ur/Ue	L/R			
Direct current	<b>DC21A</b> frequent operation	<b>DC21B</b> infrequent operation	Switching of resistive loads including moderate overloads			1	1	1ms	1	1	1ms	1,5	1,05	1ms	1,5	1,05	1ms
	<b>DC22A</b> frequent operation	<b>DC22B</b> infrequent operation	Switching of mixed resistive a.induct. loads incl. moderate overloads (shunt motors)			1	1	2ms	1	1	2ms	4	1,05	2,5ms	4	1,05	2,5ms
	<b>DC-PV1</b>		Switching of single PV string(s) without reverse- and overcurrents.			1	1	1ms	1	1	1ms	1,5	1,05	1ms	1,5	1,05	1ms
	<b>DC-PV2</b>		Switching of several PV strings with reverse- and overcurrents.			1	1	1ms	1	1	1ms	4	1,05	1ms	4	1,05	1ms

## Data according to IEC 60947-3, VDE 0660, GB14048.3 (CCC China)

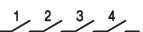

Main contacts		Type	LSM16	LSM25	
Rated thermal current $I_{th}$		A	16	25	
Rated insulation voltage $U_i$ <sup>1)</sup>		V	1000	1000	
Rated insulation voltage $U_i$ <sup>2)</sup>		V	1500	1500	
Distance of contacts (per pole)		mm	8	8	
<b>Rated operational current <math>I_e</math></b>					
1 pole					
	300V	A	16	23	
	400V	A	12	14	
<b>DC21A and DC21B</b>	A1 	500V	A	9	11
		600V	A	6	8
		700V	A	4,5	6
		800V	A	3	4
		900V	A	2,5	3
		1000V	A	1,5	2
2 poles in series					
	500V	A	16	25	
	600V	A	16	25	
	700V	A	16	23	
		800V	A	16	20
		900V	A	13	16
		1000V	A	9	11
		1200V	A	6	8
		1500V	A	3	4
2 poles in series + 2 poles parallel					
	500V	A	29	45	
	600V	A	29	45	
	700V	A	16	23	
		800V	A	16	20
		900V	A	13	16
		1000V	A	9	11
		1200V	A	6	8
	1500V	A	3	4	
4 poles in series					
	500V	A	16	25	
	600V	A	16	25	
	700V	A	16	25	
		800V	A	16	25
		900V	A	16	25
		1000V	A	16	25
		1200V	A	16	25
	1500V	A	16	20	
<b>Rated operational current <math>I_e</math></b>					
<b>AC21B</b>	A2, A4	$U_e$ max. 440V	A	16	25
	A2 + 2	$U_e$ max. 440V	A	29	45

1) Suitable at overvoltage category I to III, pollution degree 3 (standard-industry):  $U_{imp} = 8kV$ .

2) Suitable at overvoltage category I to III, pollution degree 2 (min. IP55):  $U_{imp} = 8kV$ .

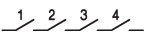

# Technical Data

Data according to IEC 60947-3, VDE 0660

Main contacts		Type	LSM16	LSM25		
<b>DC-PV1</b> Rated operational current I <sub>e</sub>	300V	A	16	23		
	1 pole 400V	A	14	22		
	A1 500V	A	10	17		
		600V	A	7	12	
		700V	A	5	6	
		800V	A	3	4	
		900V	A	3	3	
		1000V	A	2	2	
		2 poles in series A2	500V	A	16	25
			600V	A	16	25
	700V		A	16	25	
	800V		A	16	19	
	900V		A	16	17	
	1000V		A	10	11,5	
	1100V		A	8	10	
	1200V		A	7	8,5	
	1300V		A	6	7	
	1400V		A	5	6	
	1500V		A	3	5	
2 poles in series + 2 poles parallel A2+2	500V		A	29	45	
	600V	A	29	36		
	700V	A	22	27		
	800V	A	17	19		
	900V	A	16	17		
	1000V	A	10	11,5		
	1100V	A	8	10		
	1200V	A	7	8,5		
	1300V	A	6	7		
	1400V	A	5	6		
	1500V	A	3	5		
4 poles in series A4	500V	A	16	25		
	600V	A	16	25		
	700V	A	16	25		
	800V	A	16	25		
	900V	A	16	25		
	1000V	A	16	25		
	1100V	A	16	25		
	1200V	A	16	25		
	1300V	A	16	25		
	1400V	A	16	25		
	1500V	A	16	25		

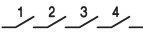

# Technical Data

Data according to IEC 60947-3, VDE 0660

Main contacts		Typ	LSM16	LSM25		
<b>Rated operational current I<sub>e</sub></b> <b>DC-PV2</b>	1 polel	300V	A	16	23	
		400V	A	15	18	
	A1 	500V	A	10	12	
		600V	A	5	6	
		700V	A	1,5	2	
		800V	A	1,5	2	
		900V	A	1	1,5	
		1000V	A	1	1,5	
		2 poles in series A2 	500V	A	16	25
			600V	A	14	21
	700V		A	13	19	
	800V		A	12	15	
	900V		A	8	10	
	1000V		A	4	5	
	1100V		A	3	4	
	1200V		A	2	3	
	1300V		A	1,5	2	
	1400V		A	1	2	
	1500V	A	1	1,5		
2 poles in series + 2 poles parallel A2+2 	500V	A	25	39		
	600V	A	20	32		
	700V	A	13	19		
	800V	A	12	15		
	900V	A	8	10		
	1000V	A	4	5		
	1100V	A	3	4		
	1200V	A	2	3		
	1300V	A	1,5	2		
	1400V	A	1	2		
	1500V	A	1	1,5		
	4poles in series A4 	500V	A	16	25	
		600V	A	16	25	
700V		A	16	25		
800V		A	16	25		
900V		A	16	25		
1000V		A	16	25		
1100V		A	16	25		
1200V		A	13,5	21		
1300V		A	12	19		
1400V		A	10,5	16		
1500V		A	9	14		

# Technical Data

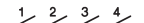

Data according to IEC 60947-3, VDE 0660

Main contacts		Type	LSM16	LSM25
<b>Rated operational current I<sub>e</sub></b>	500V	A	1	1,25
<b>DC22B</b> 1 pole A1 	600V	A	0,5	0,75
	800V	A	0,3	0,4
	1000V	A	0,15	0,2
	1200V	A	-	-
	1500V	A	-	-
2 poles in series A2 	500V	A	7	8
	600V	A	5,5	6
	800V	A	2	2,5
	1000V	A	1	1,5
	1200V	A	-	-
	1500V	A	-	-
4 poles in series A4 	500V	A	16	25
	600V	A	16	25
	800V	A	11,5	12
	1000V	A	8	9
	1200V	A	-	-
	1500V	A	-	-
<b>Rated conditional short-circuit current</b>		kA <sub>eff</sub>	5	5
Max. fuse size	gL (gG)	A	40	63
Mechanical life		x10 <sup>3</sup>	10	10
Rated short-time withstand current (1s)	lcw	A2, A4	800	900
		A2+2	1300	1500
Short circuit making capacity	lcm	A2, A4	800	900
		A2+2	1300	1500
<b>Maximum cable cross sections</b> (incl. jumper LSMV-B1)				
solid or stranded		mm <sup>2</sup>	1,5 - 10	4 - 10
flexible		mm <sup>2</sup>	1,5 - 6	4 - 10
flexible (+ multicore cable end)		mm <sup>2</sup>	1,5 - 6	4 - 10
Size of terminal screw		Nm	M3,5 Pz1	M3,5 Pz1
Tightening torque			1,4	1,4
2 cables per clamp without jumper LSMV-B1				
solid or stranded		mm <sup>2</sup>	10+(1,5-2,5) / 6+(1,5-6) / 4+(1,5-4)	
flexible		mm <sup>2</sup>	(0,5-6)+(0,5-6)	
stranded		AWG	6+(20-14) / 8+(20-12) / 10+(20-10) 12+(20-12)	
solid		AWG	10+(16-10) / 12+(16-12) 14+(16-14)	
<b>Maximum ambient temperature</b>				
Operation	open	°C	-40 to +65	
	enclosed	°C	-40 to +45	
Storage		°C	-50 to +90	
<b>Power loss</b> per switch at I <sub>e</sub> max.			A	A
A2	(A)/ W	(16)/	1	(25)/ 2,3
A4	(A)/ W	(16)/	2	(25)/ 4,6
A2+2	(A)/ W	(29)/	1,5	(45)/ 3,7
<b>Contact resistance</b> per pole			mΩ	
			1,75	1,75





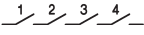

# Technical Data

Data according to UL508I  File E359344, Category no.: NMSJ, and UL508  File E332938, Category no.: NRNT2, NRNT8

Type			LSM16	LSM25	
Ampere-Rating "General use"  1 Pol	DC				
	350V	A	4	5	
	500V	A	4	5	
	600V	A	4	5	
	700V	A	-	-	
	800V	A	-	-	
	900V	A	-	-	
	1000V	A	-	-	
	 2 Pole in Serie A2	350V	A	16	25
		500V	A	16	25
600V		A	16	25	
700V		A	-	-	
800V		A	-	-	
900V		A	-	-	
1000V		A	-	-	
 2 Pole in Serie + 2 Pole parallel A2+2		350V	A	29	45
		400V	A	-	-
		500V	A	29	38
	600V	A	21	27	
	700V	A	-	-	
	800V	A	-	-	
	900V	A	-	-	
	1000V	A	-	-	
	 4 Pole in Serie A4	350V	A	16	25
		500V	A	16	25
600V		A	16	25	
700V		A	-	-	
800V		A	-	-	
900V		A	-	-	
Fuse size (RK5)Industrial Control Switch 5kA / 600V	A		40	60	
	<b>Maximum cable cross sections</b> (incl. jumper LSMV-B1)				
solid or stranded	AWG		16 - 10	16 - 10	
flexible	AWG		20 - 6	20 - 6	
flexible (+ multicore cable end)	AWG		20 - 6	20 - 6	
Size of terminal screw			M3,5 Pz1	M3,5 Pz1	
Tightening torque	lb.inch		12,4	12,4	
Protection class of terminals <sup>1)</sup>			IP20	IP20	

1) Protection degree of the terminals with connected insulated conductor.

## Approvals

Country	USA, UL508I 	US, Canada UL508 	Europe 	China CCC 	CB- certificates	EAC 
Type						
LSM16	x	x	/	x	x	o
LSM25	x	x	/	x	x	o

o In standard version approved / No testing required CE x pending - not provided for testing till now

# Technical Data

## Maximum current according to ambient temperature and cable cross section

Switch open LSM16..., 2 contacts in series (A2)

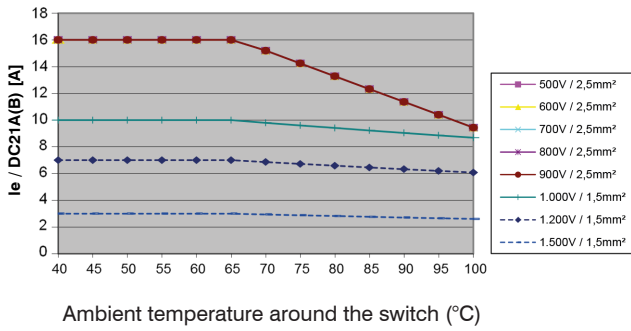

Switch open LSM16 ..., 2 contacts in series + 2 parallel (A2+2)

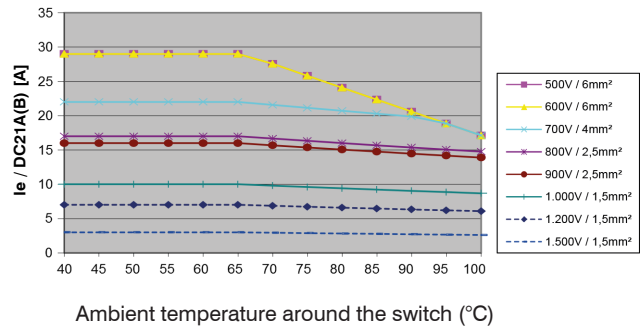

Switch open LSM16..., 4 contacts in series (A4x)

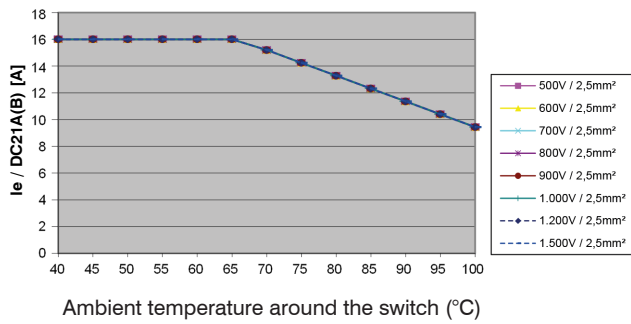

Switch enclosed LSM16 PFL..., 2 contacts in series (A2)

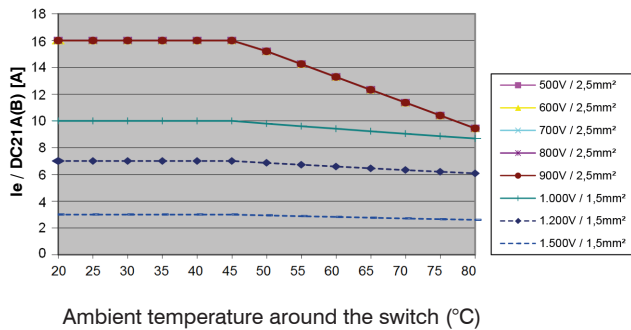

Switch enclosed LSM16 PFL..., 2 contacts in series + 2 parallel (A2+2)

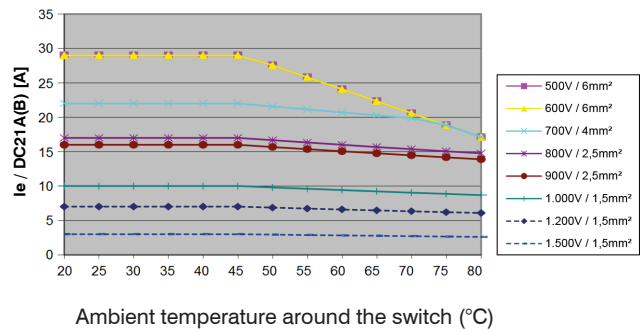

Switch enclosed LSM16 PFL..., 4 contacts in series (A4x)

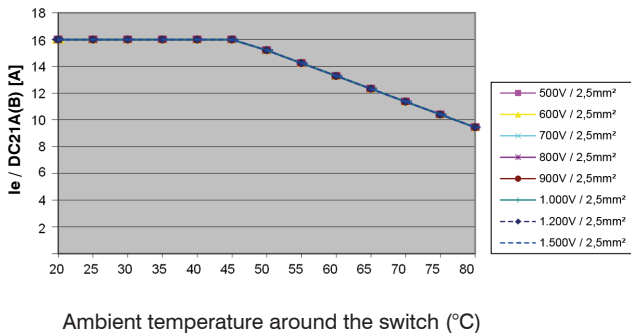

# Technical Data

## Maximum current according to ambient temperature and cable cross section

Switch open LSM25..., 2 contacts in series (A2)

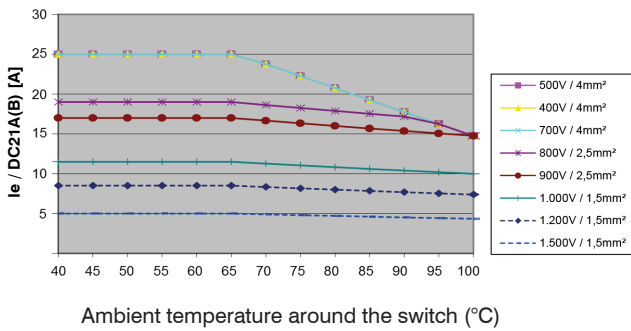

Switch open LSM25 ..., 2 contacts in series + 2 parallel (A2+2)

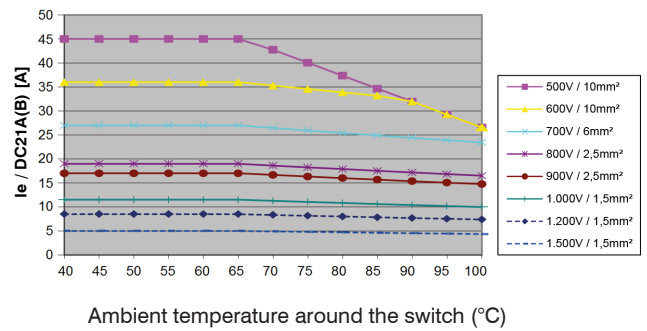

Switch open LSM25..., 4 contacts in series (A4x)

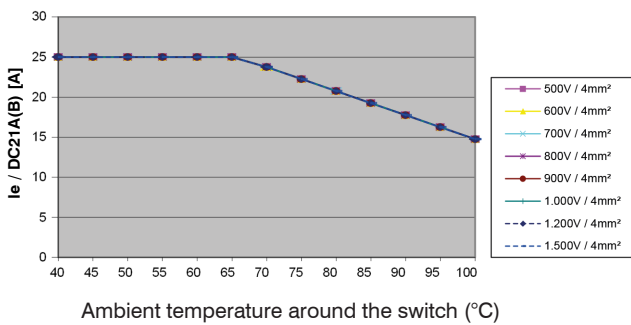

Switch enclosed LSM25 PFL..., 2 contacts in series (A2)

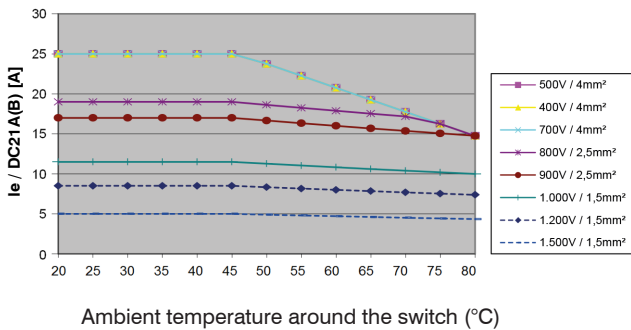

Switch enclosed LSM25 PFL..., 2 contacts in series + 2 parallel (A2+2)

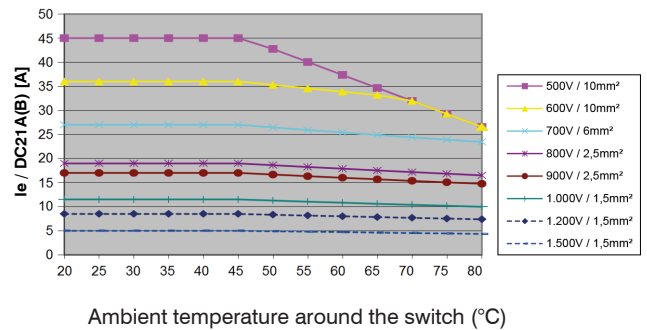

Switch enclosed LSM25 PFL..., 4 contacts in series (A4x)

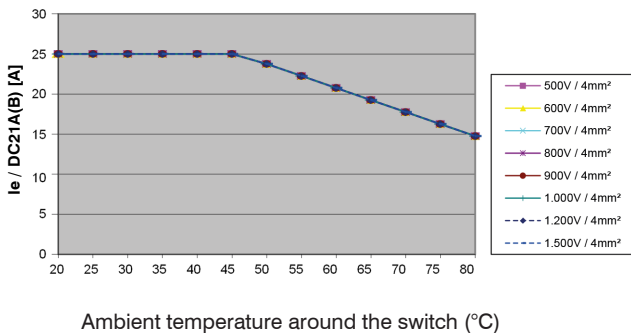

**Dimensions:**

**LSM16 E..., LSM25 E...,  
..A2**

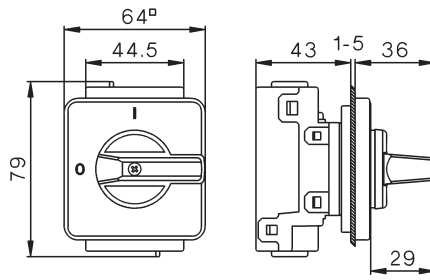

Mounting hole

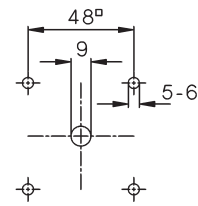

**LSM16 E..., LSM25 E...,  
..A2+2, ..A4**

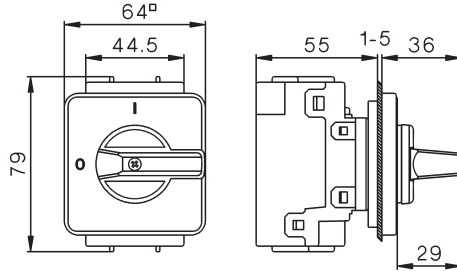

Mounting hole

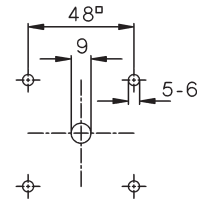

**LSM16 E2..., LSM25 E2...,  
..A2**

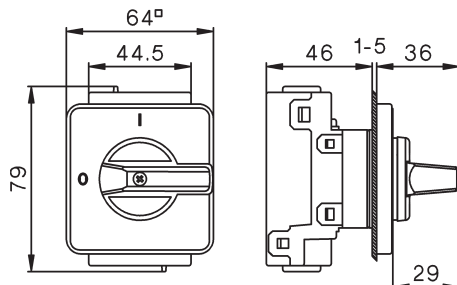

Mounting hole

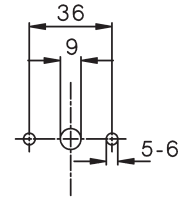

**LSM16 E2..., LSM25 E2...,  
..A2+2, ..A4**

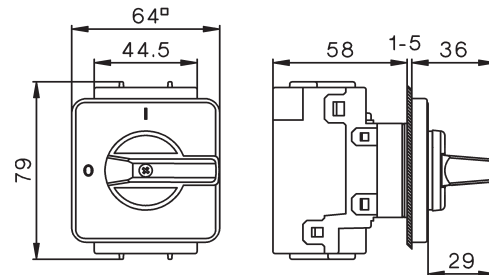

Mounting hole

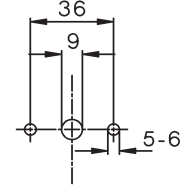

**LSM16 Z..., LSM25 Z...,  
..A2**

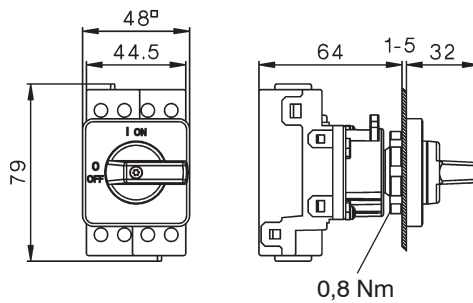

Mounting hole

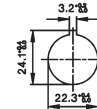

**LSM16 Z..., LSM25 Z...,  
..A2+2, ..A4**

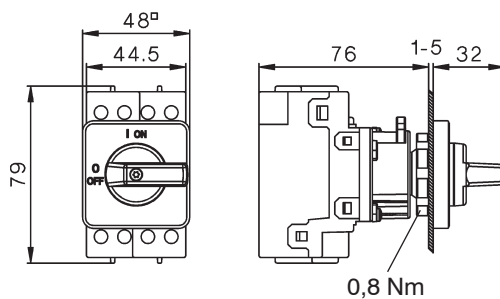

Mounting hole

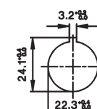

**Dimensions:**

**LSM16 Z16..., LSM25 Z16..., ..A2**

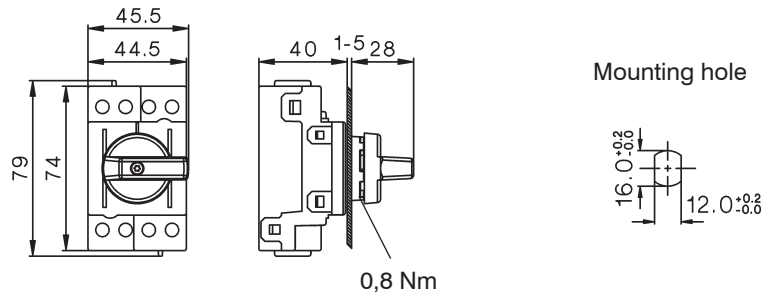

**LSM16 Z16..., LSM25 Z16..., ..A2+2, ..A4**

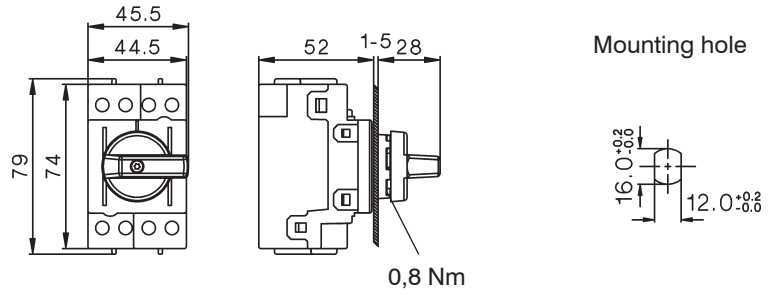

**LSM16 VZV16..., LSM25 VZV..., ..A2**

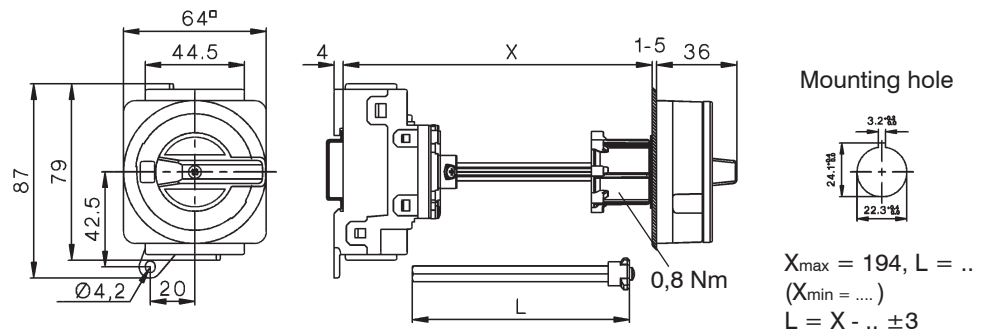

**LSM16 VZV16..., LSM25 VZV..., ..A2+2, ..A4**

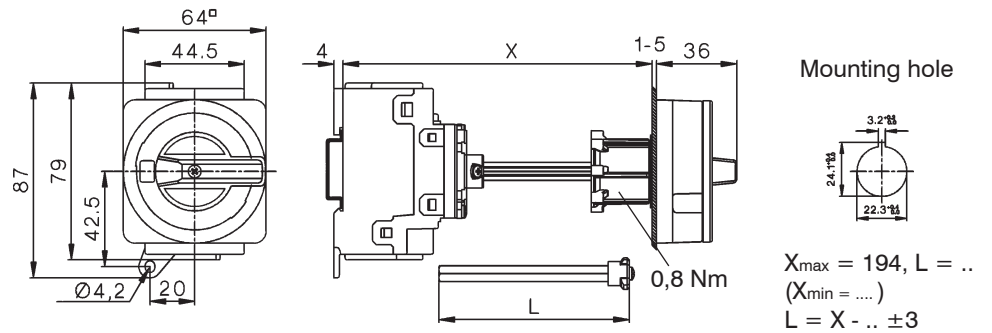

**Dimensions:**

**LSM16 SMAH1N..., LSM25 SMAH1N...,  
..A2**

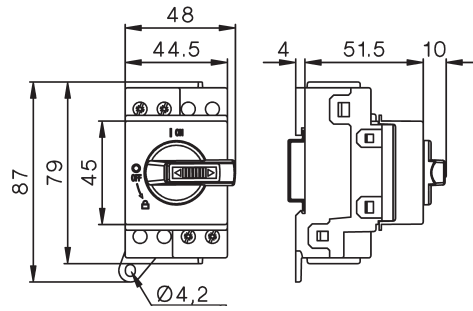

**LSM16 SMAH1N..., LSM25 SMAH1N...,  
..A2+2, ..A4**

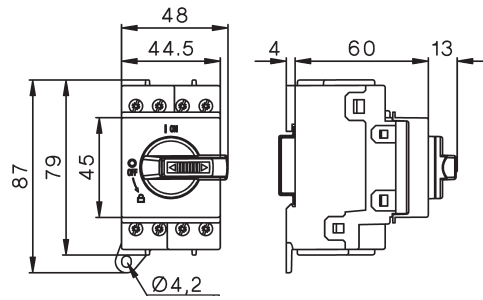

**LSM16 PFLH4..., LSM25 PFLH4...,  
..A2, ..A2+2, ..A4**

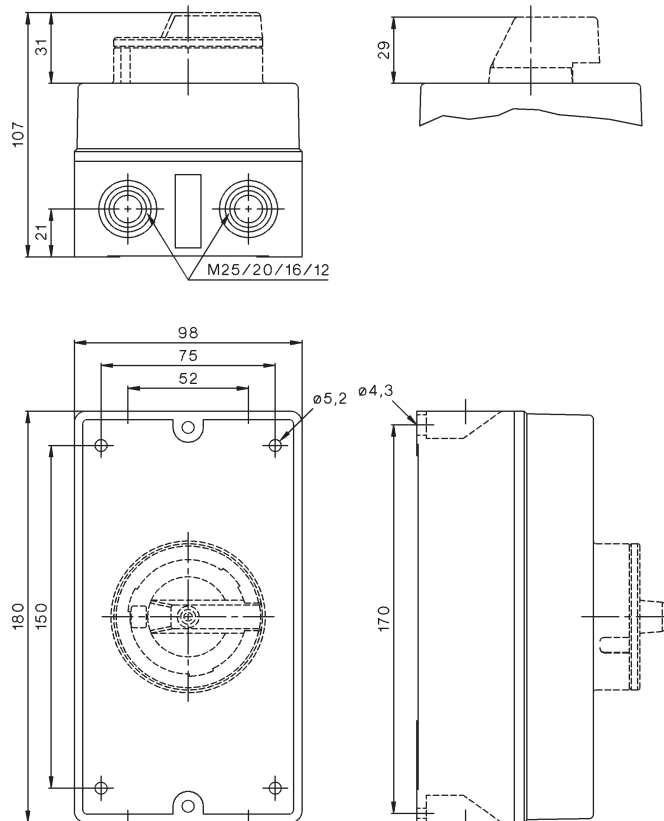



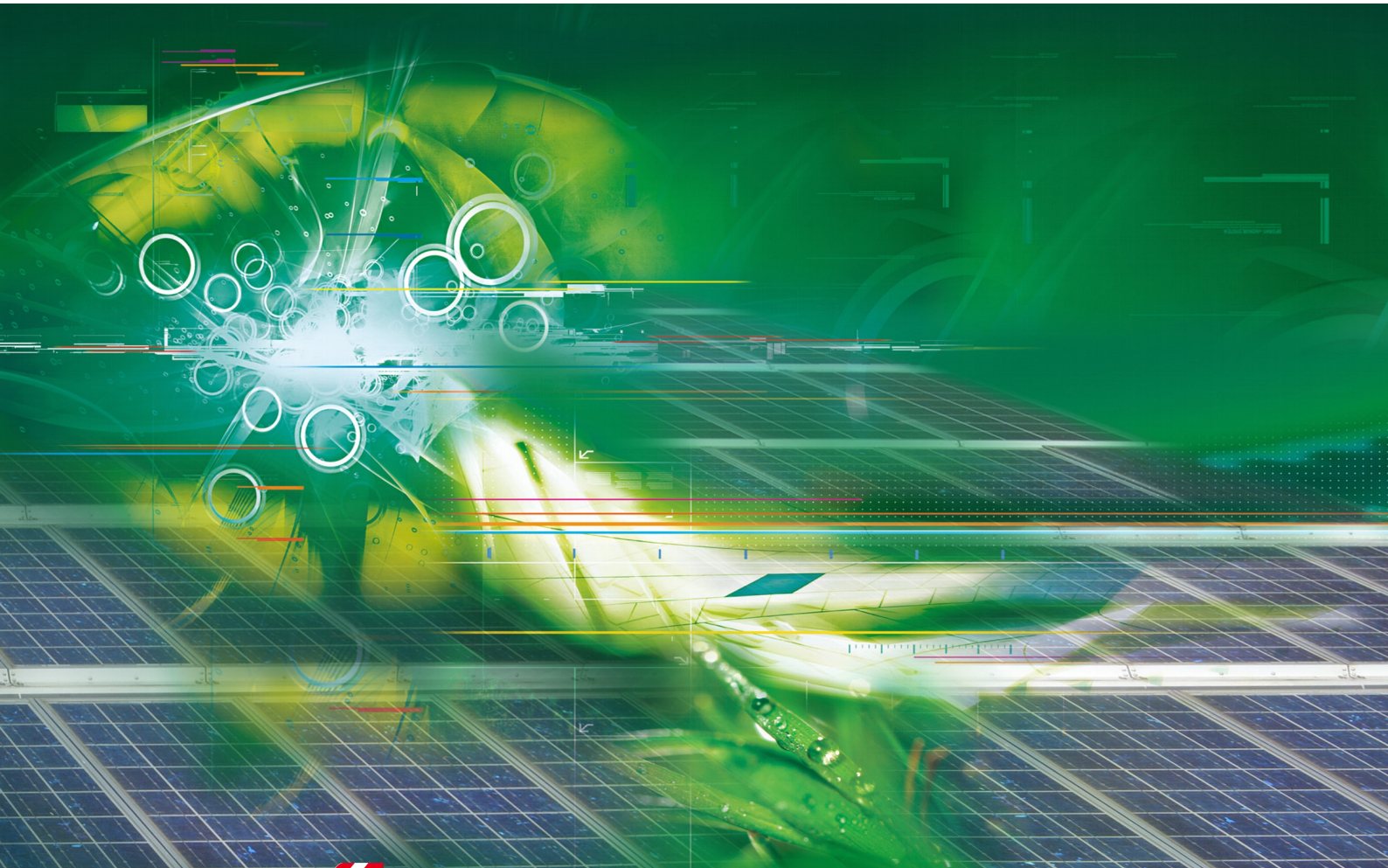

Quality made in 

D1024E171



Lieblgasse 7, A-1220 Vienna  
Phone: +43 1 251 51- 0  
Fax: +43 1 251 51-89  
e-mail: sales@benedict.at  
**www.benedict.at**

