

Inhalt

Seite



EIN-AUS-Schalter für Einbau 4-Lochbefestigung

306



EIN-AUS-Schalter für Zentralbefestigung

307



EIN-AUS-Schalter für Bodenmontage

308



EIN-AUS-Schalter für Reiheneinbau

309



Hauptschalter für Einbau 4-Lochbefestigung

310



Hauptschalter für Zentralbefestigung

311



Hauptschalter für Bodenmontage

312



Hauptschalter für Reiheneinbau

313



Hauptschalter, isolierstoffgekapselt

314



Technische Daten
Approbationen

315

319

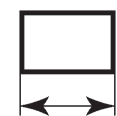

Maße

325

Schütze, Motorstarter
Leistungsschalter
Motorschutzschalter
Schalter
AC-Hauptschalter
DC-Laststromschalter
Befehls- und Meldegeräte
Vertretungen, Bezugsquellen

Nennwerte				DC-Lasttrennschalter			
Nennbetriebsstrom				Bauformen			
Typ	I _{th} offen A	DC21B(DC-PV1) bei U _e		Fronteinbau Vierlochbefestigung IP66 ¹⁾ Type 3R	Zentral- mit Tür- kupplung Ø22,5mm IP66 ¹⁾ Type 4X	Verteilereinbau IP66 ¹⁾ Type 4X	Reiheneinbau IP40 ¹⁾ Open Type
		A	4 Kontakte in Serie	V			
LS16	16	16	1500	.. E Z(O) VZV SMA ..
LS25	25	25	1500	.. E Z(O) VZV SMA ..
LS32	32	32	1500	.. E Z(O) VZV SMA ..
LS38	38	38	1500	.. E Z(O) VZV SMA ..
LS40	40	40	1500	.. E ..	-	.. VZV SMA ..
LS55	55	55	1500	.. E ..	-	.. VZV SMA ..

Lasttrennschalter für Photovoltaik

Gemäß IEC 60364-7-712 „Errichten von Photovoltaik-Versorgungssystemen“ ist eine Einrichtung zum Trennen (= Lasttrennschalter) der Photovoltaik-Module vom Wechselrichter verbindlich vorgeschrieben.

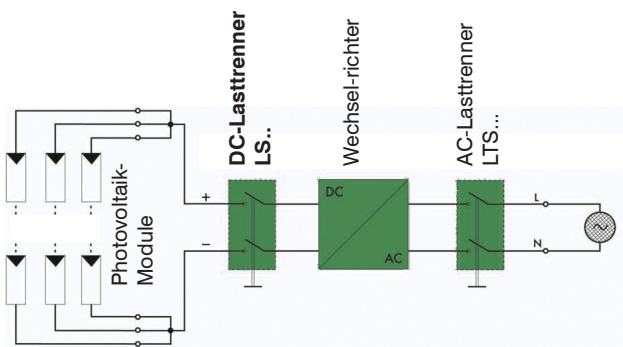

Lasttrennschalter „LS“ gewährleisten ein zuverlässiges Schalten von bis zu 85A bei 1500V in der Kategorie DC21B (DC-PV1).

Die Kontakte sind gegen Oxidation (geringe Schalthäufigkeit) und somit gegen unzulässige Erwärmung geschützt.

Der Lasttrennschalter ist mit 2, 4, 6 oder 8 schaltbaren, einzelnen Kontakten ausgestattet. Durch Serien- und Parallelschaltung der Kontakte kann die Schaltleistung entsprechend erhöht werden.

Die hohe Schaltgeschwindigkeit der Kontakte ist unabhängig von der Betätigungsgeschwindigkeit des Handgriffes.

Schaltprogramme

Typ	2-polig	2+2-polig 2 Pole in Serie + 2 Pole parallel	4-polig	4-polig mit Brücken Einspeisung oben Abgang unten	4-polig 2 Brücken oben Einspeisung und Abgang unten	4-polig 2 Brücken unten Einspeisung und Abgang oben
LS16 ... LS55	.. A2	.. A2+2	.. A4(2 x A2)	.. A4B	.. A4O	.. A4U

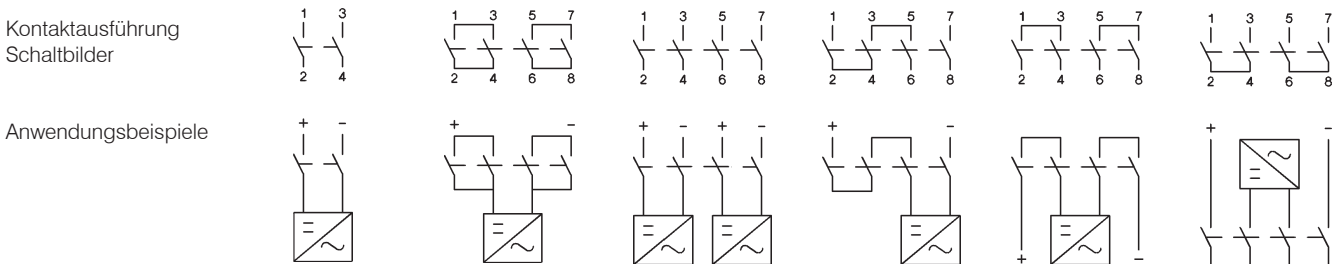

Bestellanleitung

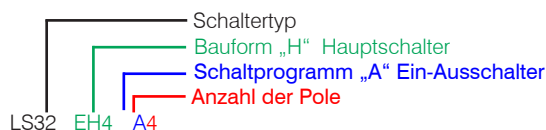

1) Schutzart von vorne im eingebauten Zustand

DC-Hauptschalter

Fronteinbau
Vierlochbefestigung
IP66¹⁾ Type 3R



Zentralbefestigung
Ø22,5mm
IP66¹⁾ Type 4X



Verteilereinbau
mit Türkupplung
IP66¹⁾ Type 4X



Reiheneinbau
IP40¹⁾ Open Type



Preßstoffgekapself
PFL..IP66/67 Type 4X



.. EH4 Z(O)H1 VZVH4 SMAH1 PFLH4 ..
.. EH4 Z(O)H1 VZVH4 SMAH1 PFLH4 ..
.. EH4 Z(O)H1 VZVH4 SMAH1 PFLH4 ..
.. EH4 Z(O)H1 VZVH4 SMAH1 PFLH4 ..
.. EH4 ..	-	.. VZVH4 SMAH1 PFLH4 ..
.. EH4 ..	-	.. VZVH4 SMAH1 PFLH4 ..

Technische Daten für DC, nach IEC 60947-3, VDE0660, weitere Daten siehe Seite 315

Typ		DC21B (DC-PV1)							DC22B				
		500V	600V	700V	800V	900V	1000V	1200V	1500V	500V	600V	800V	1000V
2 Pole in Serie 	LS16.. A	16	16	16	16	16	10	7	3	7	5,5	2	1
	LS25.. A	25	25	25	20	17	11,5	8,5	5	8	6	2,5	1,5
	LS32.. A	32	32	32	23	20	13	10	6	9	6,5	3	2
	LS38.. A	45	45	-	30	-	20	-	-	-	-	-	-
	LS40.. A	48	48	37	35	31	29	11	7,5	-	-	-	-
	LS55.. A	55	55	55	55	43	36	17	10	-	-	-	-
2 Pole in Serie+2 parallel 	LS16.. A	29	29	22	17	16	10	7	3	-	-	-	-
	LS25.. A	45	36	27	19	17	11,5	8,5	5	-	-	-	-
	LS32.. A	58	55	32	23	20	13	10	6	-	-	-	-
	LS38.. A	-	-	-	30	-	20	-	-	-	-	-	-
	LS40.. A	72	68	49	42	31	29	11	7,5	-	-	-	-
	LS55.. A	85	85	77	63	43	36	17	10	-	-	-	-
4 Pole in Serie 	LS16.. A	16	16	16	16	16	16	16	16	16	16	11,5	8
	LS25.. A	25	25	25	25	25	25	25	25	25	25	12	9
	LS32.. A	32	32	32	32	32	32	32	32	32	32	12,5	10
	LS38.. A	45	45	-	-	-	-	-	-	-	-	-	-
	LS40.. A	48	48	40	40	40	40	40	40	40	40	40	40
	LS55.. A	55	55	55	55	55	55	55	55	55	55	55	55
4 Pole in Serie+2 parallel 	LS16.. A	29	29	29	29	29	29	29	20	-	-	-	-
	LS25.. A	45	45	45	45	45	45	45	26	-	-	-	-
	LS32.. A	58	58	58	58	58	58	50	32	-	-	-	-
	LS38.. A	-	-	-	-	-	-	-	-	-	-	-	-
	LS40.. A	72	72	72	72	72	72	56	42	-	-	-	-
	LS55.. A	85	85	85	85	85	85	65	55	-	-	-	-

Typ	6-polig	3+2-polig 3 Pole in Serie +2 Pole parallel	8-polig	4+2-polig 4 Pole in serie +2 Pole parallel
LS16 ... LS55	...A6	.. A3+2	...A8	.. A4+2

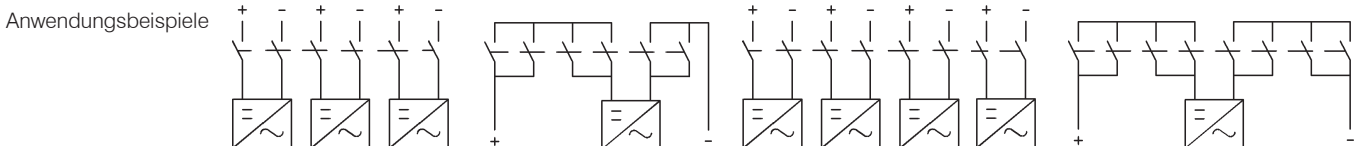
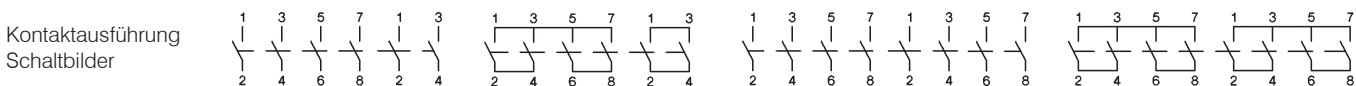

Isolierte Verbinder LSV.. für Serien- und Parallelschaltung von Kontakten



Typ	VPE	Gewicht
LS16, LS25, LS32, LS38 LSV-B1-1 ¹⁾	100	6,60 g/Stk.
LS16, LS25, LS32, LS38 LSV-B1-2 ¹⁾	100	5,90 g/Stk.
LS40, LS55 LSV-B2 ¹⁾	100	9,64 g/Stk.
LS40, LS55 LSV-B2-1 ¹⁾	100	7,50 g/Stk.

1) Auswahl und Details zu den Verbindern siehe S. 329

Ein-Aus-Schalter, Fronteinbau m. Vierlochbefestigung, Schild 64', Schutzart IP66, Type 3R



DC21B / DC-PV1		Anzahl Pole in Serie	Anzahl Strings	Typ	VPE Stk.	Gewicht kg/Stk.
600V DC	1000V DC					
16A	10A	2	1	LS16 E A2	1	0,20
25A	11,5A	2	1	LS25 E A2	1	0,20
32A	13A	2	1	LS32 E A2	1	0,20
45A	20A	2	1	LS38 E A2	1	0,20
48A	29A	2	1	LS40 E A2	1	0,41
55A	36A	2	1	LS55 E A2	1	0,41

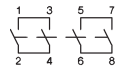

29A	10A	2	1	LS16 E A2+2	1	0,25
36A	11,5A	2	1	LS25 E A2+2	1	0,25
55A	13A	2	1	LS32 E A2+2	1	0,25
-	20A	2	1	LS38 E A2+2	1	0,25
68A	29A	2	1	LS40 E A2+2	1	0,54
85A	36A	2	1	LS55 E A2+2	1	0,54

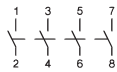

16A	10A	2	2	LS16 E A4	1	0,23
25A	11,5A	2	2	LS25 E A4	1	0,23
32A	13A	2	2	LS32 E A4	1	0,23
45A	20A	2	2	LS38 E A4	1	0,23
48A	29A	2	2	LS40 E A4	1	0,49
55A	36A	2	2	LS55 E A4	1	0,49

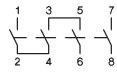

16A	16A	4	1	LS16 E A4B	1	0,24
25A	25A	4	1	LS25 E A4B	1	0,24
32A	32A	4	1	LS32 E A4B	1	0,24
45A	-	4	1	LS38 E A4B	1	0,24
48A	40A	4	1	LS40 E A4B	1	0,52
55A	55A	4	1	LS55 E A4B	1	0,52

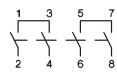

16A	16A	4	1	LS16 E A4O	1	0,24
25A	25A	4	1	LS25 E A4O	1	0,24
32A	32A	4	1	LS32 E A4O	1	0,24
45A	-	4	1	LS38 E A4O	1	0,24
48A	40A	4	1	LS40 E A4O	1	0,52
55A	55A	4	1	LS55 E A4O	1	0,52

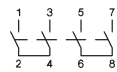

16A	16A	4	1	LS16 E A4U	1	0,24
25A	25A	4	1	LS25 E A4U	1	0,24
32A	32A	4	1	LS32 E A4U	1	0,24
45A	-	4	1	LS38 E A4U	1	0,24
48A	40A	4	1	LS40 E A4U	1	0,52
55A	55A	4	1	LS55 E A4U	1	0,52

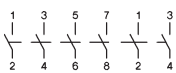

16A	10A	2	3	LS16 E A6	1	0,36
25A	11,5A	2	3	LS25 E A6	1	0,36
32A	13A	2	3	LS32 E A6	1	0,36
45A	20A	2	3	LS38 E A6	1	0,36
48A	29A	2	3	LS40 E A6	1	0,99
55A	36A	2	3	LS55 E A6	1	0,99

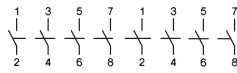

16A	10A	2	4	LS16 E A8	1	0,41
25A	11,5A	2	4	LS25 E A8	1	0,41
32A	13A	2	4	LS32 E A8	1	0,41
45A	20A	2	4	LS38 E A8	1	0,41
48A	29A	2	4	LS40 E A8	1	1,09
55A	36A	2	4	LS55 E A8	1	1,09

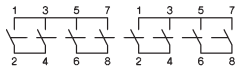

29A	29A	4	1	LS16 E A4+2	1	0,46
45A	45A	4	1	LS25 E A4+2	1	0,46
58A	58A	4	1	LS32 E A4+2	1	0,46
-	-	4	1	LS38 E A4+2	1	0,46
72A	72A	4	1	LS40 E A4+2	1	1,20
85A	85A	4	1	LS55 E A4+2	1	1,20













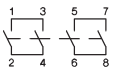

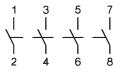

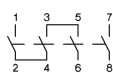
Verlängerte Schalterwelle für Schalter für Fronteinbau

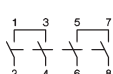
Typenzusatz

+VW"x"

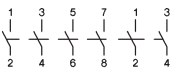
x = Panelstärke

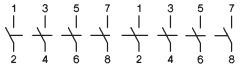
Ein-Aus-Schalter, Zentralbefestigung Ø22mm, Schild 48^r, Schutzart IP66, US Type 4X

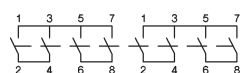
	DC21B / DC-PV1		Anzahl Pole in Serie	Anzahl Strings	Typ	VPE Stk.	Gewicht kg/Stk.
	600V DC	1000V DC					
			2	1	LS16 Z A2	1	0,21
	16A	10A	2	1	LS25 Z A2	1	0,21
	25A	11,5A	2	1	LS32 Z A2	1	0,21
	32A	13A	2	1	LS38 Z A2	1	0,21
			2	1	LS16 Z A2+2	1	0,26
	29A	10A	2	1	LS25 Z A2+2	1	0,26
	36A	11,5A	2	1	LS32 Z A2+2	1	0,26
	55A	13A	2	1	LS38 Z A2+2	1	0,26
			2	2	LS16 Z A4	1	0,23
	16A	10A	2	2	LS25 Z A4	1	0,23
	25A	11,5A	2	2	LS32 Z A4	1	0,23
	32A	13A	2	2	LS38 Z A4	1	0,23
			4	1	LS16 Z A4B	1	0,25
	16A	16A	4	1	LS25 Z A4B	1	0,25
	25A	25A	4	1	LS32 Z A4B	1	0,25
	32A	32A	4	1	LS38 Z A4B	1	0,25
			4	1	LS16 Z A4O	1	0,25
	16A	16A	4	1	LS25 Z A4O	1	0,25
	25A	25A	4	1	LS32 Z A4O	1	0,25
	32A	32A	4	1	LS38 Z A4O	1	0,25
			4	1	LS16 Z A4U	1	0,25
	16A	16A	4	1	LS25 Z A4U	1	0,25
	25A	25A	4	1	LS32 Z A4U	1	0,25
	32A	32A	4	1	LS38 Z A4U	1	0,25
			2	3	LS16 Z A6	1	0,38
	16A	10A	2	3	LS25 Z A6	1	0,38
	25A	11,5A	2	3	LS32 Z A6	1	0,38
	32A	13A	2	3	LS38 Z A6	1	0,38
			2	4	LS16 Z A8	1	0,43
	16A	10A	2	4	LS25 Z A8	1	0,43
	25A	11,5A	2	4	LS32 Z A8	1	0,43
	32A	13A	2	4	LS38 Z A8	1	0,43
			4	1	LS16 Z A4+2	1	0,48
	29A	29A	4	1	LS25 Z A4+2	1	0,48
	45A	45A	4	1	LS32 Z A4+2	1	0,48
	58A	58A	4	1	LS38 Z A4+2	1	0,48
			4	1	LS38 Z A4+2	1	0,48

Ein-Aus-Schalter, Zentralbefestigung Ø22mm, ohne Schild, Schutzart IP66, US Typ 4X



bei Type „Z“ durch „ZO“ ersetzen

LS.. ZO A.

Ein-Aus-Schalter, Bodenmontage, Türkupplung für Zentralbefestigung, Schild 64', IP66, Type 4X





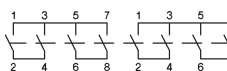
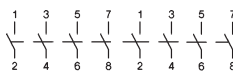
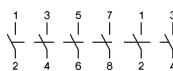
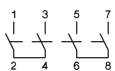
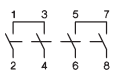
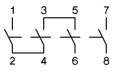
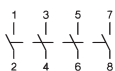
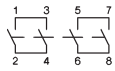





Einbautiefe einstellbar

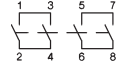

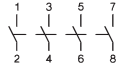
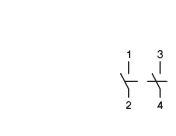
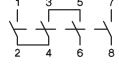
DC21B / DC-PV1		Anzahl Pole in Serie	Anzahl Strings	Typ	VPE Stk.	Gewicht kg/Stk.
600V DC	1000V DC					
16A	10A	2	1	LS16 VZV A2	1	0,22
25A	11,5A	2	1	LS25 VZV A2	1	0,22
32A	13A	2	1	LS32 VZV A2	1	0,22
45A	20A	2	1	LS38 VZV A2	1	0,22
48A	29A	2	1	LS40 VZV A2	1	0,51
55A	36A	2	1	LS55 VZV A2	1	0,51
29A	10A	2	1	LS16 VZV A2+2	1	0,27
36A	11,5A	2	1	LS25 VZV A2+2	1	0,27
55A	13A	2	1	LS32 VZV A2+2	1	0,27
-	20A	2	1	LS38 VZV A2+2	1	0,27
68A	29A	2	1	LS40 VZV A2+2	1	0,55
85A	36A	2	1	LS55 VZV A2+2	1	0,55
16A	10A	2	2	LS16 VZV A4	1	0,25
25A	11,5A	2	2	LS25 VZV A4	1	0,25
32A	13A	2	2	LS32 VZV A4	1	0,25
45A	20A	2	2	LS38 VZV A4	1	0,25
48A	29A	2	2	LS40 VZV A4	1	0,56
55A	36A	2	2	LS55 VZV A4	1	0,56
16A	16A	4	1	LS16 VZV A4B	1	0,26
25A	25A	4	1	LS25 VZV A4B	1	0,26
32A	32A	4	1	LS32 VZV A4B	1	0,26
45A	-	4	1	LS38 VZV A4B	1	0,26
48A	40A	4	1	LS40 VZV A4B	1	0,58
55A	55A	4	1	LS55 VZV A4B	1	0,58
16A	16A	4	1	LS16 VZV A4O	1	0,26
25A	25A	4	1	LS25 VZV A4O	1	0,26
32A	32A	4	1	LS32 VZV A4O	1	0,26
45A	-	4	1	LS38 VZV A4O	1	0,26
48A	40A	4	1	LS40 VZV A4O	1	0,58
55A	55A	4	1	LS55 VZV A4O	1	0,58
16A	16A	4	1	LS16 VZV A4U	1	0,26
25A	25A	4	1	LS25 VZV A4U	1	0,26
32A	32A	4	1	LS32 VZV A4U	1	0,26
45A	-	4	1	LS38 VZV A4U	1	0,26
48A	40A	4	1	LS40 VZV A4U	1	0,58
55A	55A	4	1	LS55 VZV A4U	1	0,58
16A	10A	2	3	LS16 VZV A6	1	0,38
25A	11,5A	2	3	LS25 VZV A6	1	0,38
32A	13A	2	3	LS32 VZV A6	1	0,38
45A	20A	2	3	LS38 VZV A6	1	0,38
48A	29A	2	3	LS40 VZV A6	1	1,00
55A	36A	2	3	LS55 VZV A6	1	1,00
16A	10A	2	4	LS16 VZV A8	1	0,43
25A	11,5A	2	4	LS25 VZV A8	1	0,43
32A	13A	2	4	LS32 VZV A8	1	0,43
45A	20A	2	4	LS38 VZV A8	1	0,43
48A	29A	2	4	LS40 VZV A8	1	1,10
55A	36A	2	4	LS55 VZV A8	1	1,10
29A	29A	4	1	LS16 VZV A4+2	1	0,48
45A	45A	4	1	LS25 VZV A4+2	1	0,48
58A	58A	4	1	LS32 VZV A4+2	1	0,48
-	-	4	1	LS38 VZV A4+2	1	0,48
72A	72A	4	1	LS40 VZV A4+2	1	1,21
85A	85A	4	1	LS55 VZV A4+2	1	1,21

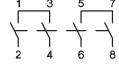
Ein-Aus-Schalter, Reiheneinbau, Schutzart IP40, Open Type

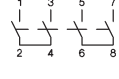
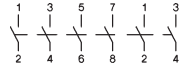
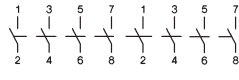
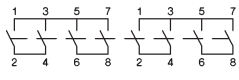
		DDC21B / DC-PV1 600V DC 1000V DC	Anzahl Pole in Serie	Anzahl Strings	Typ	VPE Stk.	Gewicht kg/Stk.
		16A 10A	2	1	LS16 SMA A2	1	0,19
		25A 11,5A	2	1	LS25 SMA A2	1	0,19
		32A 13A	2	1	LS32 SMA A2	1	0,19
		45A 20A	2	1	LS38 SMA A2	1	0,19
		48A 29A	2	1	LS40 SMA A2	1	0,41
		55A 36A	2	1	LS55 SMA A2	1	0,41
		29A 10A	2	1	LS16 SMA A2+2	1	0,24
		36A 11,5A	2	1	LS25 SMA A2+2	1	0,24
		55A 13A	2	1	LS32 SMA A2+2	1	0,24
		- 20A	2	1	LS38 SMA A2+2	1	0,24
		68A 29A	2	1	LS40 SMA A2+2	1	0,52
		85A 36A	2	1	LS55 SMA A2+2	1	0,52
		16A 10A	2	2	LS16 SMA A4	1	0,22
		25A 11,5A	2	2	LS25 SMA A4	1	0,22
		32A 13A	2	2	LS32 SMA A4	1	0,22
		45A 20A	2	2	LS38 SMA A4	1	0,22
		48A 29A	2	2	LS40 SMA A4	1	0,45
		55A 36A	2	2	LS55 SMA A4	1	0,45
		16A 16A	4	1	LS16 SMA A4B	1	0,23
		25A 25A	4	1	LS25 SMA A4B	1	0,23
		32A 32A	4	1	LS32 SMA A4B	1	0,23
		45A -	4	1	LS32 SMA A4B	1	0,23
		48A 40A	4	1	LS40 SMA A4B	1	0,49
		55A 55A	4	1	LS55 SMA A4B	1	0,49
		16A 16A	4	1	LS16 SMA A4O	1	0,23
		25A 25A	4	1	LS25 SMA A4O	1	0,23
		32A 32A	4	1	LS32 SMA A4O	1	0,23
		45A -	4	1	LS38 SMA A4O	1	0,23
		48A 40A	4	1	LS40 SMA A4O	1	0,49
		55A 55A	4	1	LS55 SMA A4O	1	0,49
		16A 16A	4	1	LS16 SMA A4U	1	0,23
		25A 25A	4	1	LS25 SMA A4U	1	0,23
		32A 32A	4	1	LS32 SMA A4U	1	0,23
		45A -	4	1	LS38 SMA A4U	1	0,23
		48A 40A	4	1	LS40 SMA A4U	1	0,49
		55A 55A	4	1	LS55 SMA A4U	1	0,49
		16A 10A	2	3	LS16 SMA A6	1	0,35
		25A 11,5A	2	3	LS25 SMA A6	1	0,35
		32A 13A	2	3	LS32 SMA A6	1	0,35
		45A 20A	2	3	LS38 SMA A6	1	0,35
		48A 29A	2	3	LS40 SMA A6	1	0,89
		55A 36A	2	3	LS55 SMA A6	1	0,89
		16A 10A	2	4	LS16 SMA A8	1	0,40
		25A 11,5A	2	4	LS25 SMA A8	1	0,40
		32A 13A	2	4	LS32 SMA A8	1	0,40
		45A 20A	2	4	LS38 SMA A8	1	0,40
		48A 29A	2	4	LS40 SMA A8	1	0,99
		55A 36A	2	4	LS55 SMA A8	1	0,99
		29A 29A	4	1	LS16 SMA A4+2	1	0,43
		45A 45A	4	1	LS25 SMA A4+2	1	0,43
		58A 58A	4	1	LS32 SMA A4+2	1	0,43
		- -	4	1	LS38 SMA A4+2	1	0,43
		72A 72A	4	1	LS40 SMA A4+2	1	1,01
		85A 85A	4	1	LS55 SMA A4+2	1	1,01

Schütze, Motorstarter
Leistungsschalter
Motorschutzschalter
Schalter
AC-Hauptschalter
DC-Lasttrennschalter
Befehls- und Meldegeräte
Vertretungen, Bezugsquellen

Hauptschalter, Fronteinbau m. Vierlochbefestigung, Schild 64r, Schutzart IP66,



Sperrvorrichtung SV4

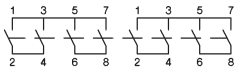
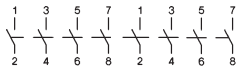
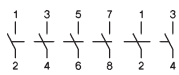
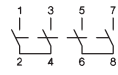
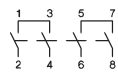
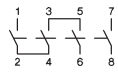
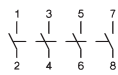
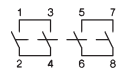

DC21B / DC-PV1 600V DC 1000V DC	Anzahl Pole in Serie	Anzahl Strings	Typ	VPE Stk.	Gewicht kg/Stk.
16A 10A	2	1	LS16 EH4 A2	1	0,21
25A 11,5A	2	1	LS25 EH4 A2	1	0,21
32A 13A	2	1	LS32 EH4 A2	1	0,21
45A 20A	2	1	LS38 EH4 A2	1	0,21
48A 29A	2	1	LS40 EH4 A2	1	0,43
55A 36A	2	1	LS55 EH4 A2	1	0,43
29A 10A	2	1	LS16 EH4 A2+2	1	0,26
36A 11,5A	2	1	LS25 EH4 A2+2	1	0,26
55A 13A	2	1	LS32 EH4 A2+2	1	0,26
- 20A	2	1	LS38 EH4 A2+2	1	0,26
68A 29A	2	1	LS40 EH4 A2+2	1	0,57
85A 36A	2	1	LS55 EH4 A2+2	1	0,57
16A 10A	2	2	LS16 EH4 A4	1	0,24
25A 11,5A	2	2	LS25 EH4 A4	1	0,24
32A 13A	2	2	LS32 EH4 A4	1	0,24
45A 20A	2	2	LS38 EH4 A4	1	0,24
48A 29A	2	2	LS40 EH4 A4	1	0,50
55A 36A	2	2	LS55 EH4 A4	1	0,50
16A 16A	4	1	LS16 EH4 A4B	1	0,25
25A 25A	4	1	LS25 EH4 A4B	1	0,25
32A 32A	4	1	LS32 EH4 A4B	1	0,25
45A -	4	1	LS38 EH4 A4B	1	0,25
48A 40A	4	1	LS40 EH4 A4B	1	0,53
55A 55A	4	1	LS55 EH4 A4B	1	0,53
16A 16A	4	1	LS16 EH4 A4O	1	0,25
25A 25A	4	1	LS25 EH4 A4O	1	0,25
32A 32A	4	1	LS32 EH4 A4O	1	0,25
45A -	4	1	LS38 EH4 A4O	1	0,25
48A 40A	4	1	LS40 EH4 A4O	1	0,53
55A 55A	4	1	LS55 EH4 A4O	1	0,53
16A 16A	4	1	LS16 EH4 A4U	1	0,25
25A 25A	4	1	LS25 EH4 A4U	1	0,25
32A 32A	4	1	LS32 EH4 A4U	1	0,25
45A -	4	1	LS38 EH4 A4U	1	0,25
48A 40A	4	1	LS40 EH4 A4U	1	0,53
55A 55A	4	1	LS55 EH4 A4U	1	0,53
16A 10A	2	3	LS16 EH4 A6	1	0,37
25A 11,5A	2	3	LS25 EH4 A6	1	0,37
32A 13A	2	3	LS32 EH4 A6	1	0,37
45A 20A	2	3	LS38 EH4 A6	1	0,37
48A 29A	2	3	LS40 EH4 A6	1	0,53
55A 36A	2	3	LS55 EH4 A6	1	0,53
16A 10A	2	4	LS16 EH4 A8	1	0,42
25A 11,5A	2	4	LS25 EH4 A8	1	0,42
32A 13A	2	4	LS32 EH4 A8	1	0,42
45A 20A	2	4	LS38 EH4 A8	1	0,42
48A 29A	2	4	LS40 EH4 A8	1	1,10
55A 36A	2	4	LS55 EH4 A8	1	1,10
29A 29A	4	1	LS16 EH4 A4+2	1	0,47
45A 45A	4	1	LS25 EH4 A4+2	1	0,47
58A 58A	4	1	LS32 EH4 A4+2	1	0,47
- -	4	1	LS38 EH4 A4+2	1	0,47
72A 72A	4	1	LS40 EH4 A4+2	1	1,21
85A 85A	4	1	LS55 EH4 A4+2	1	1,21







Verlängerte Schalterwelle für Schalter für Fronteinbau

Typenzusatz

+VW"x"

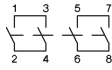
x = Panelstärke

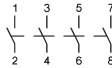
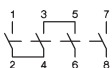
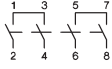
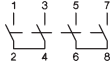
Hauptschalter, Zentralbefestigung Ø22mm, Schild 48°, Schutzart IP66,

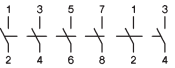
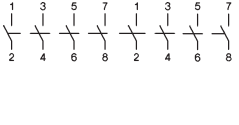
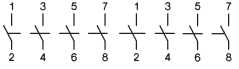
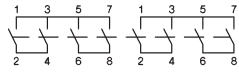
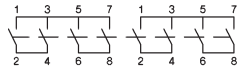
	DC21B / DC-PV1		Anzahl Pole in Serie	Anzahl Strings	Typ	VPE Stk.	Gewicht kg/Stk.
	600V DC	1000V DC					
			2	1	LS16 ZH1 A2	1	0,21
	16A	10A	2	1	LS25 ZH1 A2	1	0,21
	25A	11,5A	2	1	LS32 ZH1 A2	1	0,21
	32A	13A	2	1	LS38 ZH1 A2	1	0,21
	45A	20A	2	1	LS38 ZH1 A2	1	0,21
Sperrvorrichtung SV1			2	1	LS16 ZH1 A2+2	1	0,27
	29A	10A	2	1	LS25 ZH1 A2+2	1	0,27
	36A	11,5A	2	1	LS32 ZH1 A2+2	1	0,27
	55A	13A	2	1	LS32 ZH1 A2+2	1	0,27
	-	20A	2	1	LS38 ZH1 A2+2	1	0,27
			2	2	LS16 ZH1 A4	1	0,24
	16A	10A	2	2	LS25 ZH1 A4	1	0,24
	25A	11,5A	2	2	LS32 ZH1 A4	1	0,24
	32A	13A	2	2	LS32 ZH1 A4	1	0,24
	45A	20A	2	2	LS38 ZH1 A4	1	0,24
			4	1	LS16 ZH1 A4B	1	0,25
	16A	16A	4	1	LS25 ZH1 A4B	1	0,25
	25A	25A	4	1	LS32 ZH1 A4B	1	0,25
	32A	32A	4	1	LS32 ZH1 A4B	1	0,25
	45A	-	4	1	LS38 ZH1 A4B	1	0,25
			4	1	LS16 ZH1 A4O	1	0,25
	16A	16A	4	1	LS25 ZH1 A4O	1	0,25
	25A	25A	4	1	LS32 ZH1 A4O	1	0,25
	32A	32A	4	1	LS32 ZH1 A4O	1	0,25
	45A	-	4	1	LS38 ZH1 A4O	1	0,25
		4	1	LS16 ZH1 A4U	1	0,25	
16A	16A	4	1	LS25 ZH1 A4U	1	0,25	
25A	25A	4	1	LS32 ZH1 A4U	1	0,25	
32A	32A	4	1	LS32 ZH1 A4U	1	0,25	
45A	-	4	1	LS38 ZH1 A4U	1	0,25	
			2	3	LS16 ZH1 A6	1	0,39
	16A	10A	2	3	LS25 ZH1 A6	1	0,39
	25A	11,5A	2	3	LS32 ZH1 A6	1	0,39
	32A	13A	2	3	LS32 ZH1 A6	1	0,39
	45A	20A	2	3	LS38 ZH1 A6	1	0,39
			2	4	LS16 ZH1 A8	1	0,44
	16A	10A	2	4	LS25 ZH1 A8	1	0,44
	25A	11,5A	2	4	LS32 ZH1 A8	1	0,44
	32A	13A	2	4	LS32 ZH1 A8	1	0,44
	45A	20A	2	4	LS38 ZH1 A8	1	0,44
			4	1	LS16 ZH1 A4+2	1	0,49
	29A	29A	4	1	LS25 ZH1 A4+2	1	0,49
	45A	45A	4	1	LS32 ZH1 A4+2	1	0,49
	58A	58A	4	1	LS32 ZH1 A4+2	1	0,49
	-	-	4	1	LS38 ZH1 A4+2	1	0,49

Hauptschalter, Zentralbefestigung Ø22mm, ohne Schild, Schutzart IP66,

bei Type „ZH1“ durch „ZOH1“ ersetzen **LS.. ZOH1 A.**

Hauptschalter, Bodenmontage, Türkupplung für Zentralbefestigung, Schild 64, Schutzart IP66, Type 4X



DC21B / DC-PV1		Anzahl Pole in Serie	Anzahl Strings	Typ	VPE Stk.	Gewicht kg/Stk.
600V DC	1000V DC					
16A	10A	2	1	LS16 VZVH4 A2	1	0,23
25A	11,5A	2	1	LS25 VZVH4 A2	1	0,23
32A	13A	2	1	LS32 VZVH4 A2	1	0,23
45A	20A	2	1	LS38 VZVH4 A2	1	0,23
48A	29A	2	1	LS40 VZVH4 A2	1	0,51
55A	36A	2	1	LS55 VZVH4 A2	1	0,51

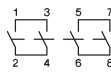

29A	10A	2	1	LS16 VZVH4 A2+2	1	0,28
36A	11,5A	2	1	LS25 VZVH4 A2+2	1	0,28
55A	13A	2	1	LS32 VZVH4 A2+2	1	0,28
-	20A	2	1	LS38 VZVH4 A2+2	1	0,28
68A	29A	2	1	LS40 VZVH4 A2+2	1	0,65
85A	36A	2	1	LS55 VZVH4 A2+2	1	0,65

Einbautiefe einstellbar

Sperrvorrichtung SV4

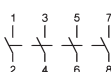

16A	10A	2	2	LS16 VZVH4 A4	1	0,26
25A	11,5A	2	2	LS25 VZVH4 A4	1	0,26
32A	13A	2	2	LS32 VZVH4 A4	1	0,26
45A	20A	2	2	LS38 VZVH4 A4	1	0,26
48A	29A	2	2	LS40 VZVH4 A4	1	0,58
55A	36A	2	2	LS55 VZVH4 A4	1	0,58

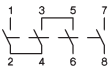

16A	16A	4	1	LS16 VZVH4 A4B	1	0,27
25A	25A	4	1	LS25 VZVH4 A4B	1	0,27
32A	32A	4	1	LS32 VZVH4 A4B	1	0,27
45A	-	4	1	LS38 VZVH4 A4B	1	0,27
48A	40A	4	1	LS40 VZVH4 A4B	1	0,62
55A	55A	4	1	LS55 VZVH4 A4B	1	0,62

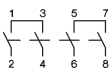

16A	16A	4	1	LS16 VZVH4 A4O	1	0,27
25A	25A	4	1	LS25 VZVH4 A4O	1	0,27
32A	32A	4	1	LS32 VZVH4 A4O	1	0,27
45A	-	4	1	LS38 VZVH4 A4O	1	0,27
48A	40A	4	1	LS40 VZVH4 A4O	1	0,62
55A	55A	4	1	LS55 VZVH4 A4O	1	0,62

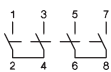

16A	16A	4	1	LS16 VZVH4 A4U	1	0,27
25A	25A	4	1	LS25 VZVH4 A4U	1	0,27
32A	32A	4	1	LS32 VZVH4 A4U	1	0,27
45A	-	4	1	LS38 VZVH4 A4U	1	0,27
48A	40A	4	1	LS40 VZVH4 A4U	1	0,62
55A	55A	4	1	LS55 VZVH4 A4U	1	0,62

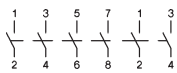

16A	10A	2	3	LS16 VZVH4 A6	1	0,39
25A	11,5A	2	3	LS25 VZVH4 A6	1	0,39
32A	13A	2	3	LS32 VZVH4 A6	1	0,39
45A	20A	2	3	LS38 VZVH4 A6	1	0,39
48A	29A	2	3	LS40 VZVH4 A6	1	1,00
55A	36A	2	3	LS55 VZVH4 A6	1	1,00

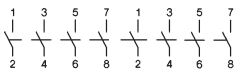

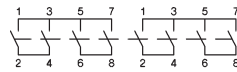

16A	10A	2	4	LS16 VZVH4 A8	1	0,44
25A	11,5A	2	4	LS25 VZVH4 A8	1	0,44
32A	13A	2	4	LS32 VZVH4 A8	1	0,44
45A	20A	2	4	LS38 VZVH4 A8	1	0,44
48A	29A	2	4	LS40 VZVH4 A8	1	1,11
55A	36A	2	4	LS55 VZVH4 A8	1	1,11



29A	29A	4	1	LS16 VZVH4 A4+2	1	0,49
45A	45A	4	1	LS25 VZVH4 A4+2	1	0,49
58A	58A	4	1	LS32 VZVH4 A4+2	1	0,49
-	-	4	1	LS38 VZVH4 A4+2	1	0,49
72A	72A	4	1	LS40 VZVH4 A4+2	1	1,22
85A	85A	4	1	LS55 VZVH4 A4+2	1	1,22

Hauptschalter, Reiheneinbau, versperbar, Schutzart IP40, Open Type

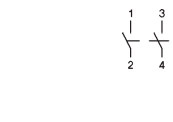
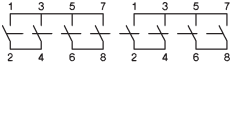
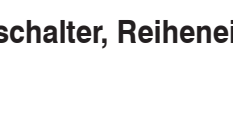
	DC21B / DC-PV1		Anzahl Pole in Serie	Anzahl Strings	Typ	VPE Stk.	Gewicht kg/Stk.
	600V DC	1000V DC					
							
Sperrvorrichtung SV1 							
							
							
							
							

1) Hauptschalter, Reiheneinbau mit niedrigem Griff, versperbar, Schutzart IP40, Open Type

Typ mit Typenzusatz „+SV1N“ z.B.: **LS.. SMAH1 A2+2 +SV1N**

Hauptschalter, isolierstoffgekapselt, Schild 64^r, Schutzart IP66/67, Type 4X



Sperrvorrichtung SV4

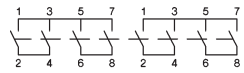
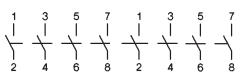
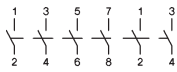
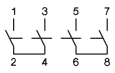
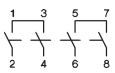
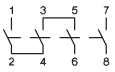
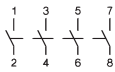
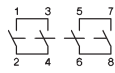

DC21B / DC-PV1 600V DC 1000V DC	Anzahl Pole in Serie	Anzahl Strings	Typ	VPE Stk.	Gewicht kg/Stk.
16A 10A	2	1	LS16 PFLH4 A2 ¹⁾	1	0,43
25A 11,5A	2	1	LS25 PFLH4 A2 ¹⁾	1	0,43
32A 13A	2	1	LS32 PFLH4 A2 ¹⁾	1	0,43
45A 20A	2	1	LS38 PFLH4 A2 ¹⁾	1	0,43
48A 29A	2	1	LS40 PFLH4 A2	1	1,59
55A 36A	2	1	LS55 PFLH4 A2	1	1,59
29A 10A	2	1	LS16 PFLH4 A2+2 ¹⁾	1	0,49
36A 11,5A	2	1	LS25 PFLH4 A2+2 ¹⁾	1	0,49
55A 13A	2	1	LS32 PFLH4 A2+2 ¹⁾	1	0,49
- 20A	2	1	LS38 PFLH4 A2+2 ¹⁾	1	0,49
68A 29A	2	1	LS40 PFLH4 A2+2	1	1,74
85A 36A	2	1	LS55 PFLH4 A2+2	1	1,74
16A 10A	2	2	LS16 PFLH4 A4 ¹⁾	1	0,46
25A 11,5A	2	2	LS25 PFLH4 A4 ¹⁾	1	0,46
32A 13A	2	2	LS32 PFLH4 A4 ¹⁾	1	0,46
45A 20A	2	2	LS38 PFLH4 A4 ¹⁾	1	0,46
48A 29A	2	2	LS40 PFLH4 A4	1	1,67
55A 36A	2	2	LS55 PFLH4 A4	1	1,67
16A 16A	4	1	LS16 PFLH4 A4B ¹⁾	1	0,47
25A 25A	4	1	LS25 PFLH4 A4B ¹⁾	1	0,47
32A 32A	4	1	LS32 PFLH4 A4B ¹⁾	1	0,47
45A -	4	1	LS38 PFLH4 A4B ¹⁾	1	0,47
48A 40A	4	1	LS40 PFLH4 A4B	1	1,70
55A 55A	4	1	LS55 PFLH4 A4B	1	1,70
16A 16A	4	1	LS16 PFLH4 A4O ¹⁾	1	0,47
25A 25A	4	1	LS25 PFLH4 A4O ¹⁾	1	0,47
32A 32A	4	1	LS32 PFLH4 A4O ¹⁾	1	0,47
45A -	4	1	LS38 PFLH4 A4O ¹⁾	1	0,47
48A 40A	4	1	LS40 PFLH4 A4O	1	1,70
55A 55A	4	1	LS55 PFLH4 A4O	1	1,70
16A 16A	4	1	LS16 PFLH4 A4U ¹⁾	1	0,47
25A 25A	4	1	LS25 PFLH4 A4U ¹⁾	1	0,47
32A 32A	4	1	LS32 PFLH4 A4U ¹⁾	1	0,47
45A -	4	1	LS38 PFLH4 A4U ¹⁾	1	0,47
48A 40A	4	1	LS40 PFLH4 A4U	1	1,70
55A 55A	4	1	LS55 PFLH4 A4U	1	1,70
16A 10A	2	3	LS16 PFLH4 A6	1	1,53
25A 11,5A	2	3	LS25 PFLH4 A6	1	1,53
32A 13A	2	3	LS32 PFLH4 A6	1	1,53
45A 20A	2	3	LS38 PFLH4 A6	1	1,53
48A 29A	2	3	LS40 PFLH4 A6	1	1,87
55A 36A	2	3	LS55 PFLH4 A6	1	1,87
16A 10A	2	4	LS16 PFLH4 A8	1	1,58
25A 11,5A	2	4	LS25 PFLH4 A8	1	1,58
32A 13A	2	4	LS32 PFLH4 A8	1	1,58
45A 20A	2	4	LS38 PFLH4 A8	1	1,58
48A 29A	2	4	LS40 PFLH4 A8	1	1,94
55A 36A	2	4	LS55 PFLH4 A8	1	1,94
29A 29A	4	1	LS16 PFLH4 A4+2	1	1,63
45A 45A	4	1	LS25 PFLH4 A4+2	1	1,63
58A 58A	4	1	LS32 PFLH4 A4+2	1	1,63
- -	4	1	LS38 PFLH4 A4+2	1	1,63
72A 72A	4	1	LS40 PFLH4 A4+2	1	2,07
85A 85A	4	1	LS55 PFLH4 A4+2	1	2,07

Technische Daten

Stromart	Gebrauchskategorie		Typische Anwendungsfälle	Prüfungsbedingungen für Elektrische Lebensdauer (Normale Beanspruchung)						Prüfungsbedingungen für Ein- und Ausschaltvermögen (Beanspruchung im Störfall)					
				Einschalten		Ausschalten		L/R		Einschalten		Ausschalten		L/R	
	I _{le}	U _{/Ue}	L/R	I _{le}	U _{/Ue}	L/R	I _{le}	U _{/Ue}	L/R	I _{le}	U _{/Ue}	L/R	I _{le}	U _{/Ue}	L/R
Gleichstrom	DC21A häufige Betätigung	DC21B gelegentl. Betätigung	Schalten von ohmscher Last einschließlich geringer Überlast.	1	1	1ms	1	1	1ms	1,5	1,05	1ms	1,5	1,05	1ms
	DC22A häufige Betätigung	DC22B gelegentl. Betätigung	Schalten von gemischter ohmscher und induktiver Last einschließl. geringer Überlast.	1	1	2ms	1	1	2ms	4	1,05	2,5ms	4	1,05	2,5ms
	DC-PV1		Schalten eines einzelnen PV String(s) ohne Rück- und Überströme.	1	1	1ms	1	1	1ms	1,5	1,05	1ms	1,5	1,05	1ms
	DC-PV2		Schalten von mehreren PV Strings mit Rück- und Überströmen.	1	1	1ms	1	1	1ms	4	1,05	1ms	4	1,05	1ms

Daten nach IEC 60947-3, VDE 0660, GB/T14048.3 (CCC China)



Hauptkontakte		Typ	LS16	LS25	LS32	LS38	LS40	LS55	
Thermischer Bemessungsbetriebsstrom I _{th}		A	16	25	32	45	48	55	
Bemessungsisolationsspannung U _i ¹⁾		V	1000	1000	1000	1000	1500	1500	
Bemessungsisolationsspannung U _i ²⁾		V	1500	1500	1500	1500	1500	1500	
Kontaktabstand (pro Pol)		mm	8	8	8	8	8	8	
DC21A und DC21B	1 Pol	300V A	16	23	27		40	55	
		400V A	12/14	14/22	16/25		30/33	40/44	
	A1	500V A	9/10	11/17	13/20		19/24	25/32	
		600V A	6/7	8/12	10/15		15/19	20/25	
	1	700V A	4,5/5	6	7,5/7		10/12	15/18	
		800V A	3	4	5		8/10	10/13	
	900V A	2,5/3	3	4		6/8	8/10		
		1000V A	1,5/2	2	2,5/3		4/5	6/8	
	nur DC21B	2 Pole in Serie	500V A	16	25	32	- /45	48	55
			600V A	16	25	32	- /45	48	55
A2		700V A	16	23/25	27/32		35/37	55	
		800V A	16/16	20	- /23	- /30	35	45/55	
1 2		900V A	13/16	16/17	- /20		25/31	35/43	
		1000V A	9/10	11/11,5	13	- /20	25/29	- /36	
1200V A		6/7	8/8,5	10		10/11	15/17		
		1500V A	3	4/5	5/6		6/7,5	7,5/10	
2 Pole in Serie + 2 Pole parallel A2+2		500V A	29	45	58		72	85	
		600V A	29	45	50/55		64/68	80/85	
	700V A	16/22	23/27	27/32		35/49	55/77		
	800V A	16/17	20	- /23	- /30	35/42	45/63		
	900V A	13/16	16/17	- /20		25/31	35/43		
	1000V A	9/10	11/11,5	13	- /20	23/29	25/36		
	1200V A	6/7	8/8,5	10		10/11	15/17		
	1500V A	3	4/5	5/6		6/7,5	7,5/10		
	3 Pole in Serie + 2 Pole parallel A3+2	500V A	29	45	58		72	85	
		600V A	29	45	50/58		72	85	
700V A		29	38/43	45/55		72	85		
800V A		29	38/40	- /51		68	85		
900V A		29	- /38	- /47		62	78		
1000V A		29	- /38	- /45		58	70		
1200V A		12	14/25	16/28					
1500V A		9	11/14	13/20					
4 Pole in Serie A4		500V A	16	25	32	- /45	48	55	
		600V A	16	25	32	- /45	48	55	
	700V A	16	25	32		40	55		
	800V A	16	25	32		40	55		
	900V A	16	25	32		40	55		
	1000V A	16	25	32		40	55		
	1200V A	16	25	32		40	55		
	1500V A	16	20/25	23/32		30/40	40/55		
	4 Pole in Serie + 2 Pole parallel A4+2	500V A	29	45	58		72	85	
		600V A	29	45	58		72	85	
700V A		29	45	- /58		72	85		
800V A		29	45	- /58		72	85		
900V A		29	45	- /58		72	85		
1000V A		29	- /45	- /58		- /72	- /85		
1200V A		29	- /45	50		- /56	- /65		
1500V A		16	20/26	23/32		- /42	- /55		
Bemessungsbetriebsstrom I_e									
AC21B		A2, A4	U _e max. 440V	A	16	25	32	45	48
	A2+2	U _e max. 440V	A	29	45	58		72	85

1) Gilt für: Überspannungskategorie I bis III, Verschmutzungsgrad 3 (Norm-Industrie): U_{imp} = 8kV.

2) Gilt für: Überspannungskategorie I bis III, Verschmutzungsgrad 2 (min. IP55): U_{imp} = 8kV.

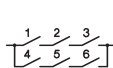
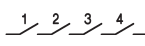
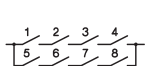

Technische Daten

Daten nach IEC 60947-3, VDE 0660

Hauptkontakte	Typ		LS16	LS25	LS32	LS38	LS40	LS55
Bemessungsbetriebsstrom I_e	300V	A	16	23	27		40	55
DC-PV1	400V	A	14	22	25		33	44
1 Pol	500V	A	10	17	20		24	32
A1	600V	A	7	12	15		19	25
	700V	A	5	6	7,5		12	18
	800V	A	3	4	5		10	13
	900V	A	3	3	4		8	10
	1000V	A	2	2	3		5	8
2 Pole in Serie	500V	A	16	25	32	45	48	55
A2	600V	A	16	25	32	45	48	55
	700V	A	16	25	32		37	55
	800V	A	16	20	23	30	35	55
	900V	A	16	17	20		31	43
	1000V	A	10	11,5	13	20	29	36
	1100V	A	8	10	11,5		19	25
	1200V	A	7	8,5	10		11	17
	1300V	A	6	7	8		10	14
	1400V	A	5	6	7		9	12
	1500V	A	3	5	6		7,5	10
2 Pole in Serie + 2 Pole parallel	500V	A	29	45	58		72	85
A2+2	600V	A	29	45	55		68	85
	700V	A	22	27	32		49	77
	800V	A	17	20	23	30	42	63
	900V	A	16	17	20		31	43
	1000V	A	10	11,5	13	20	29	36
	1100V	A	8	10	11,5		19	25
	1200V	A	7	8,5	10		11	17
	1300V	A	6	7	8		10	14
	1400V	A	5	6	7		9	12
	1500V	A	3	5	6		7,5	10
3 Pole in Serie + 2 Pole parallel	500V	A	29	45	58		72	85
A3+2	600V	A	29	45	58		72	85
	700V	A	29	43	55		72	85
	800V	A	29	40	51		68	85
	900V	A	29	38	47		62	78
	1000V	A	29	38	45		58	70
	1100V	A	19	27	37		-	-
	1200V	A	17	25	28		-	-
	1300V	A	15	21	25		-	-
	1400V	A	12	18	22		-	-
	1500V	A	10	14	20		-	-
4 Pole in Serie	500V	A	16	25	32	45	48	55
A4	600V	A	16	25	32	45	48	55
	700V	A	16	25	32		40	55
	800V	A	16	25	32		40	55
	900V	A	16	25	32		40	55
	1000V	A	16	25	32		40	55
	1100V	A	16	25	32		40	55
	1200V	A	16	25	32		40	55
	1300V	A	16	25	32		40	55
	1400V	A	16	25	32		40	55
	1500V	A	16	25	32		40	55
4 Pole in Serie + 2 Pole parallel	500V	A	29	45	58		72	85
A4+2	600V	A	29	45	58		72	85
	700V	A	29	45	58		72	85
	800V	A	29	45	58		72	85
	900V	A	29	45	58		72	85
	1000V	A	29	45	58		72	85
	1100V	A	29	45	54		60	68
	1200V	A	29	45	50		56	65
	1300V	A	26	39	44		50	61
	1400V	A	23	33	38		46	58
	1500V	A	20	26	32		42	55

Technische Daten

Daten nach IEC 60947-3, VDE 0660

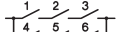
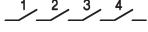
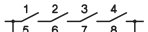
Hauptkontakte	Typ		LS16	LS25	LS32	LS38	LS40	LS55	
Bemessungsbetriebsstrom I_e DC-PV2 1 Pol A1 	300V A		16	23	27		40	55	
	400V A		14	18	20		30	40	
	500V A		10	12	14		19	25	
	600V A		5	6	8		10	13	
	700V A		1,5	2	3		7	10	
	800V A		1,5	2	3		6	8	
	900V A		1	1,5	2		5	6	
	1000V A		1	1,5	2		3	4	
	2 Pole in Serie A2 	500V A		16	25	32		40	55
		600V A		14	21	27		40	55
700V A			13	19	22		35	55	
800V A			12	15	17		33	49	
900V A			8	10	12		25	35	
1000V A			4	5	6		16	20	
1100V A			3	4	5		11	15	
1200V A			2	3	4		8	12	
1300V A			1,5	2	3		7	10	
1400V A			1	2	3		7	9	
1500V A			1	1,5	2		6	8	
2 Pole in Serie + 2 Pole parallel A2+2 		500V A		25	39	50		72	85
		600V A		20	32	35		60	75
	700V A		13	19	22		38	60	
	800V A		12	15	17		33	49	
	900V A		8	10	12		25	35	
	1000V A		4	5	6		16	20	
	1100V A		3	4	5		11	15	
	1200V A		2	3	4		8	12	
	1300V A		1,5	2	3		7	10	
	1400V A		1	2	3		7	9	
	1500V A		1	1,5	2		6	8	
	3 Pole in Serie + 2 Pole parallel A3+2 	500V A		24	45	58		72	85
		600V A		22	34	44	72	78	
700V A			20	28	34		62	69	
800V A			18	24	29		53	61	
900V A			16	20	24	44	55		
1000V A			14	18	20		35	50	
1100V A			-	-	-		-	-	
1200V A			11	13	15	-	-	-	
1300V A			-	-	-		-	-	
1400V A			-	-	-		-	-	
1500V A		4	6	8		-	-		
4 Pole in Serie A4 	500V A		16	25	32		40	55	
	600V A		16	25	32		40	55	
	700V A		16	25	32		40	55	
	800V A		16	25	32		40	55	
	900V A		16	25	32		40	55	
	1000V A		16	25	32		40	55	
	1100V A		15	25	32		40	55	
	1200V A		13,5	21	27		40	55	
	1300V A		12	19	24		36	50	
	1400V A		10,5	16	21		33	45	
1500V A		9	14	18		30	40		
4 Pole in Serie + 2 Pole parallel A4+2 	500V A		29	45	58		72	85	
	600V A		29	45	58		72	85	
	700V A		25	40	53		72	80	
	800V A		21	35	45		67	75	
	900V A		18	30	37		59	70	
	1000V A		16	25	32		52	64	
	1100V A		-	-	-		44	59	
	1200V A		13,5	21	27		40	55	
	1300V A		-	-	-		36	50	
	1400V A		-	-	-		33	45	
1500V A		9	14	18		30	40		

Schütze, Motorstarter

Leistungschalter

Motorschutzschalter

Schalter

AC-Hauptschalter

DC-Lasttrennschalter

Befehls- und Meldegeräte

Vertretungen, Bezugsquellen

Technische Daten





Daten nach IEC 60947-3, VDE 0660

Hauptkontakte		Typ	LS16	LS25	LS32	LS38	LS40	LS55
Bemessungsbetriebsstrom I_e DC22B	1 Pol	500V A	1	1,25	1,5	x	x	2,5
	A1	600V A	0,5	0,75	1	x	x	2,0
	<u>1</u>	800V A	0,3	0,4	0,5	x	x	1,5
	2 Pole in Serie	1000V A	0,15	0,2	0,25	x	x	1,0
	A2	1200V A	-	-	-	x	x	x
	<u>1</u> <u>2</u>	1500V A	-	-	-	x	x	x
	2 Pole in Serie	500V A	7	8	9	x	x	x
	A2	600V A	5,5	6	6,5	x	x	x
	<u>1</u> <u>2</u>	800V A	2	2,5	3	x	x	x
	2 Pole in Serie	1000V A	1	1,5	2	x	x	x
	A2	1200V A	-	-	-	x	x	x
	<u>1</u> <u>2</u>	1500V A	-	-	-	x	x	x
	4 Pole in Serie	500V A	16	25	32	x	x	x
	A4	600V A	16	25	27,5	x	x	x
	<u>1</u> <u>2</u> <u>3</u> <u>4</u>	800V A	11,5	12	12,5	x	x	x
4 Pole in Serie	1000V A	8	9	10	x	x	x	
A4	1200V A	-	-	-	x	x	x	
<u>1</u> <u>2</u> <u>3</u> <u>4</u>	1500V A	-	-	-	x	x	x	
Bedingter Bemessungskurzschlußstrom	kA _{eff}	5	5	5	5	10	10	
Maximale Vorsicherung	gL (gG)	A	40	63	80	80	125	160
Mechanische Lebensdauer	x10 ³		10	10	10	10	10	10
Bemessungskurzzeitstromfestigkeit (1s)	I _{cw} A2, A4, A6, A8 A2+2, A3+2, A4+2	A	800	900	1000	1000	A2, A4: 1200 A2+2: 2000	A2, A4: 1400 A2+2: 2400
Bemessungskurzschluß-einschaltvermögen	I _{cm} A2, A4, A6, A8 A2+2, A3+2, A4+2	A	800	900	1000	1000	A2, A4: 1200 A2+2: 2000	A2, A4: 1400 A2+2: 2400
Anschlußquerschnitte (inkl. Verbinder)			LSV-B1	LSV-B1	LSV-B1	LSV-B1	LSV-B2	LSV-B2
ein- oder mehrdrähtig	mm ²		4 - 16	4 - 16	4 - 16	4-16	2,5 - 25	2,5 - 25
feindrähtig	mm ²		4 - 10	4 - 10	4 - 10	4-10	2,5 - 16	2,5 - 16
feindrähtig (+ Aderendhülse)	mm ²		4 - 10	4 - 10	4 - 10	4-10	1,5 - 16	1,5 - 16
Klemmschraube	Nm		M4 Pz2	M4 Pz2	M4 Pz2	M4 Pz2	M5 Pz2	M5 Pz2
Anzugsdrehmoment			1,7 - 1,8	1,7 - 1,8	1,7 - 1,8	1,7 - 1,8	2,5 - 2,8	2,5 - 2,8
2 Leiter pro Klemme ohne Verbinder	mm ²		16+(1,5-2,5) / 10+(1,5-6) / 6+(1,5-10) / 4+(1,5-10)				16+(1,5-2,5) / 10+(1,5-10) / 6+(1,5-10) / 4+(1,5-10)	
ein- oder mehrdrähtig								
feindrähtig & feindrähtig + Aderendhülse	mm ²		16+(1,5-2,5) / 10+(1,5-4) / 6+(1,5-6)				16+(1,5-6) / 10+(1,5-10) / 6+(1,5-16) / 4+(1,5-16)	
stranded	AWG		8+(16-12) / 10+(16-10) / 12+(16-8) 14+(16-8)				3+(18-10) / 4+(18-10) / 6+(18-8) 8+(18-8)	
solid	AWG		10+(16-12) / 12+(16-10) 14+(16-10)				10+(16-10) / 12+(16-10) / 14+(16-10) 12+(16-10) / 14+(16-10)	
Zulässige Umgebungstemperatur								
Betrieb	offen	°C						-40 to +65
	gekapselt	°C						-40 to +45
Lagerung		°C						-50 to +90
Verlustleistung pro Schalter bei I _e max.			A	A	A		A	A
A2	(A)/W		(16)/ 1	(25)/ 2,3	(32)/ 3,7		(40)/ 4	(55)/ 7,5
A4	(A)/W		(16)/ 2	(25)/ 4,6	(32)/ 7,4		(40)/ 8	(55)/ 15
A6	(A)/W		(16)/ 3	(25)/ 6,9	(32)/ 11,1		(40)/ 12	(55)/ 22,5
A8	(A)/W		(16)/ 4	(25)/ 9,2	(32)/ 14,8		(40)/ 16	(55)/ 30
A2+2	(A)/W		(29)/1,5	(45)/ 3,7	(58)/ 6		(72)/ 6,5	(85)/ 9
A3+2	(A)/W		(29)/2,3	(45)/ 5,6	(58)/ 9		(72)/ 9,8	(85)/ 14
A4+2	(A)/W		(29)/3	(45)/ 7,4	(58)/ 12		(72)/ 13	(85)/ 18
Kontaktwiderstand pro Po	mΩ		1,75	1,75	1,75		1,25	1,25

x zur Approbation eingereicht



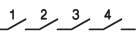
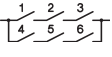
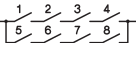

Technische Daten

Daten nach UL508I  File E359344 Category np.: NMSJ, und UL508  File E332938, Category no.: NRNT2, NRNT8

Typ			LS16	LS25	LS32	LS38	LS40	LS55	
Ampere-Rating "General use" 1 Pol 	DC								
	350V	A	4	5	6	6	7,1	10,0	
	500V	A	4	5	6	6	5,7	7,0	
	600V	A	4	5	6	6	5,0	5,8	
	700V	A	-	-	-	-	3,9	5,0	
	800V	A	-	-	-	-	3,2	4,4	
	900V	A	-	-	-	-	2,5	3,5	
	1000V	A	-	-	-	-	1,5	2,0	
	2 Pole in Serie A2 	350V	A	16	25	32	38	40	55
		500V	A	16	25	32	38	40	55
600V		A	16	25	32	36	40	55	
700V		A	-	-	-	-	32	46	
800V		A	-	-	-	-	26	37	
900V		A	-	-	-	-	20	28	
1000V		A	-	-	-	-	16	20	
2 Pole in Serie + 2 Pole parallel A2+2 	350V	A	29	45	58	58	72	85	
	400V	A	-	-	-	-	67	79	
	500V	A	29	38	40	45	53	66	
	600V	A	21	27	32	36	42	55	
	700V	A	-	-	-	-	35	47	
	800V	A	-	-	-	-	30	40	
	900V	A	-	-	-	-	26	32	
	1000V	A	-	-	-	-	22	25	
4 Pole in Serie A4 	350V	A	16	25	32	38	40	55	
	500V	A	16	25	32	38	40	55	
	600V	A	16	25	32	36	40	55	
	700V	A	-	-	-	-	40	55	
	800V	A	-	-	-	-	40	55	
	900V	A	-	-	-	-	40	55	
3 Pole in Serie + 2 Pole parallel A3+2 	350V	A	29	45	58	58	72	85	
	500V	A	29	38	50	50	56	80	
	600V	A	21	38	45	45	52	65	
	700V	A	-	-	-	-	46	58	
	800V	A	-	-	-	-	40	51	
	900V	A	-	-	-	-	36	45	
	1000V	A	-	-	-	-	33	42	
4 Pole in Serie + 2 Pole parallel A4+2 	350V	A	29	45	58	58	80	85	
	500V	A	29	45	58	58	71	85	
	600V	A	29	45	50	50	65	85	
	700V	A	-	-	-	-	58	76	
	800V	A	-	-	-	-	51	71	
	900V	A	-	-	-	-	45	67	
	1000V	A	-	-	-	-	42	64	
AC-Rating "General use" 2 Pole in Serie  2 Pole in Serie + 2 Pole parallel  3 Pole parallel	600V	A	16	25	32	-	40	55	
	277V	A	-	-	50	-	72	85	
	3x480V	A	-	-	32	-	40	55	
Fuse size (RK5) Industrial Control Switch									
5kA / 600V	A	40	60	80	80	-	-	-	
5kA/1000V	A	-	-	-	-	160	160	-	
Max. Anschlußquerschnitte inkl. Verbinder LSV-B1 / LSV-B2									
eindrätig	AWG	12 - 10	12 - 10	12 - 10	12 - 10	16 - 10	16 - 10	16 - 10	
feindrätig + mehrdrätig	AWG	12 - 6	12 - 6	12 - 6	12 - 6	14 - 4	14 - 4	14 - 4	
feindrätig (+ Aderendhülse)	AWG	12 - 6	12 - 6	12 - 6	12 - 6	-	-	-	
Klemmschraube		M4 Pz2	M4 Pz2	M4 Pz2	M4 Pz2	M5 Pz2	M5 Pz2	M5 Pz2	
Anzugsdrehmoment	lb.inch	9-16	9 - 16	9 - 16	9 - 16	22 - 25	22 - 25	22 - 25	
Schutzart der Anschlußklemmen ¹⁾		IP20	IP20	IP20	IP20	IP20	IP20	IP20	

1) Schutzart der Anschlußklemmen mit angeschlossenen, isolierten Leitern.

Approbationen

Land	USA, UL508I 	USA, Kanada UL508 	Europa 	China CCC 	CB- Zertifikate	EAC 
Type						
LS16	o	o	/	o	o	o
LS25	o	o	/	o	o	o
LS32	o	o	/	o	o	o
LS38	o	o	/	x	x	o
LS40	o	o	/	-	o	o
LS55	o	o	/	-	o	o

o In Normalausführung approbiert / Approbation nicht erforderlich CE x zur Approbation eingereicht - nicht zur Approbation vorgesehen

Technische Daten

Maximal zulässiger Strom, abhängig von Umgebungstemperatur und Anschlußquerschnitten

Schalter offen LS16..., 2 Kontakte in Serie (A2)

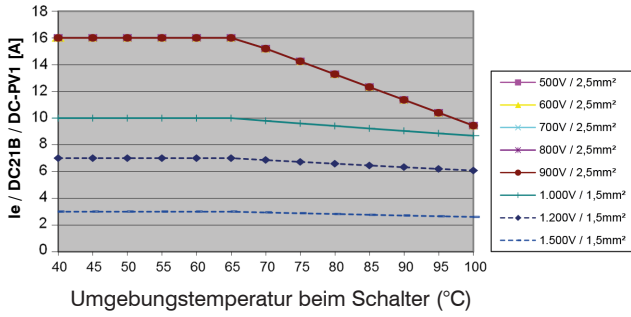

Schalter offen LS16 ..., 2 Kontakte in Serie + 2 parallel (A2+2)

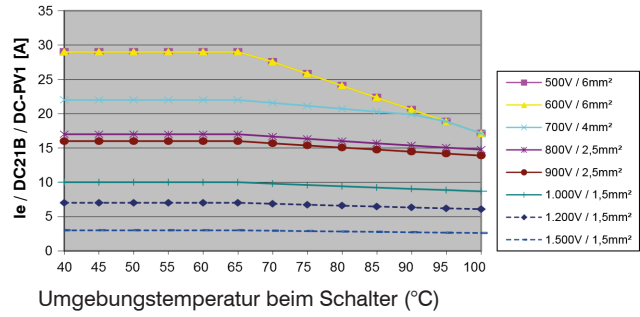

Schalter offen LS16..., 4 Kontakte in Serie (A4x)

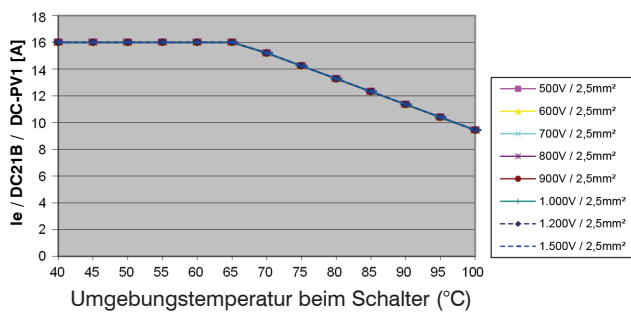

Schalter offen LS16..., 4 Kontakte in Serie + 2 parallel (A4+2)

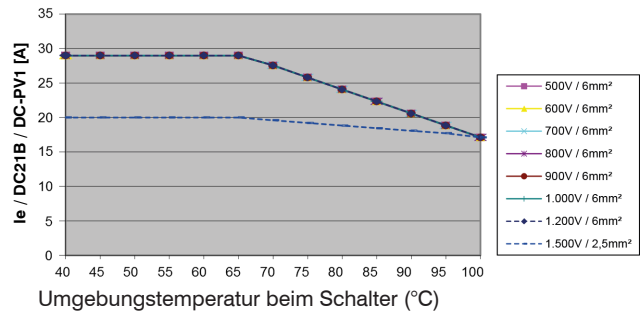

Schalter gekapselt LS16 PFL..., 2 Kontakte in Serie (A2)

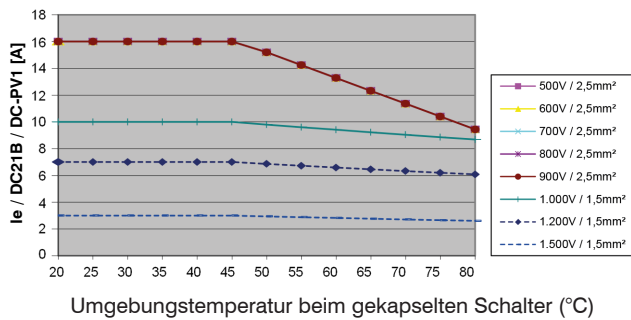

Schalter gekapselt LS16 PFL..., 2 Kontakte in Serie + 2 parallel (A2+2)

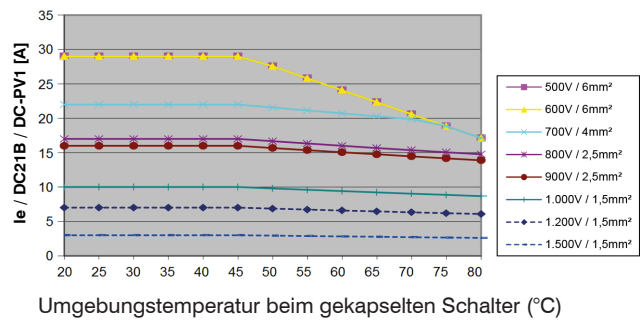

Schalter gekapselt LS16 PFL... 4 Kontakte in Serie (A4x)

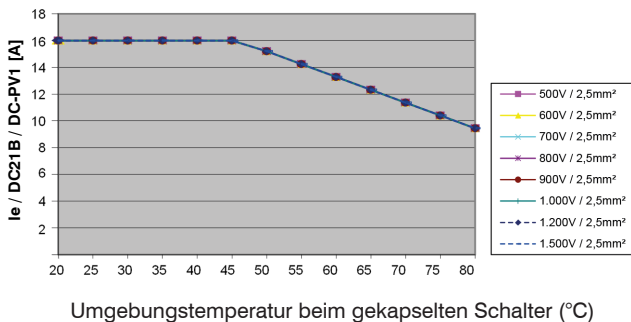

Schalter gekapselt LS16 PFL... 4 Kontakte in Serie + 2 parallel (A4+2)

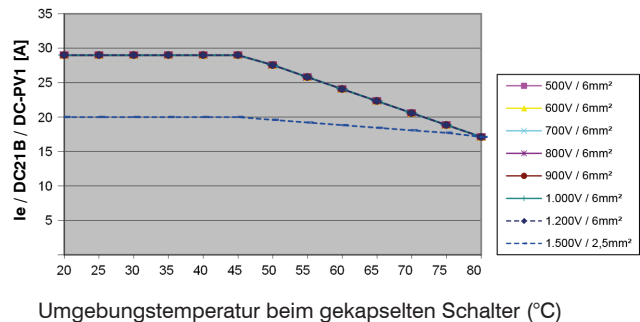

Technische Daten

Maximal zulässiger Strom, abhängig von Umgebungstemperatur und Anschlußquerschnitten

Schalter offen LS25..., 2 Kontakte in Serie (A2)

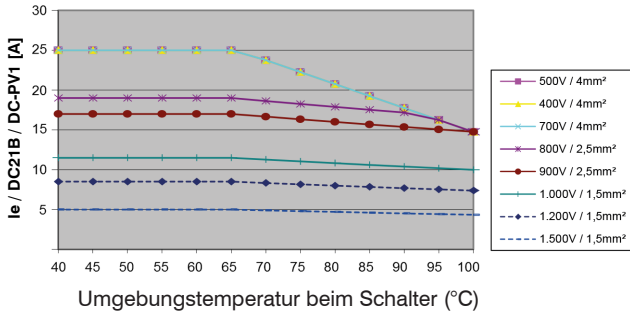

Schalter offen LS25 ..., 2 Kontakte in Serie + 2 parallel (A2+2)

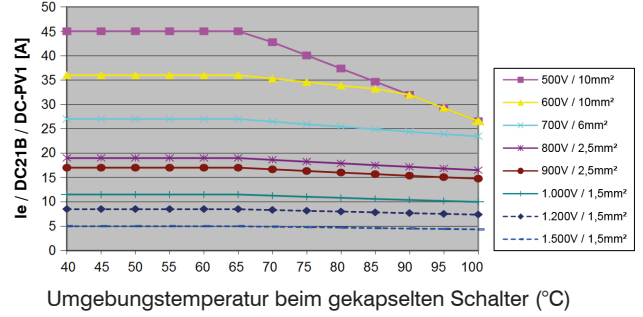

Schalter offen LS25..., 4 Kontakte in Serie (A4x)

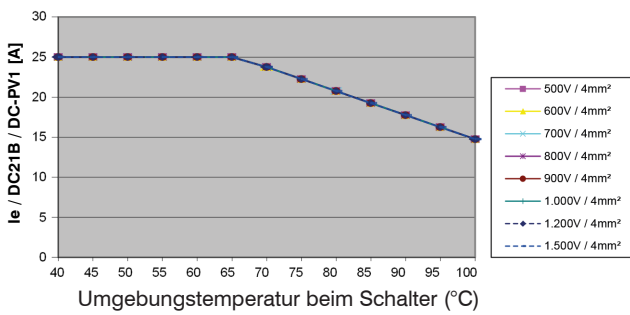

Schalter offen LS25..., 4 Kontakte in Serie + 2 parallel (A4+2)

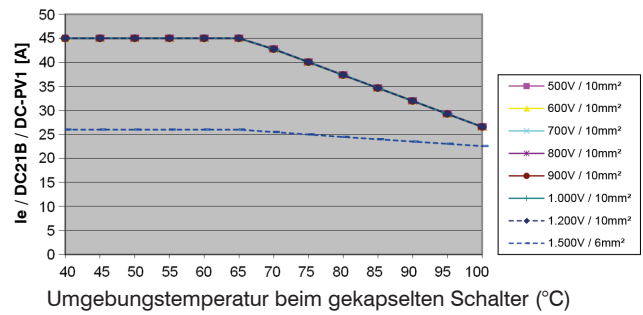

Schalter gekapselt LS25 PFL..., 2 Kontakte in Serie (A2)

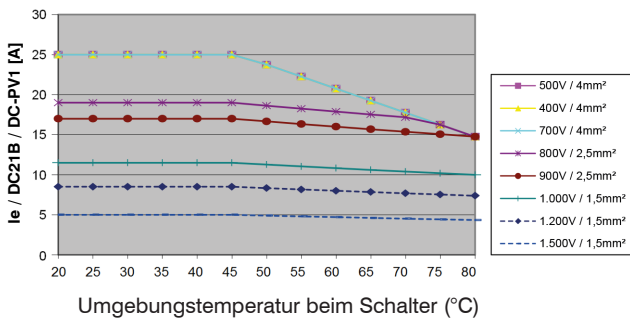

Schalter gekapselt LS25 PFL..., 2 Kontakte in Serie + 2 parallel (A2+2)

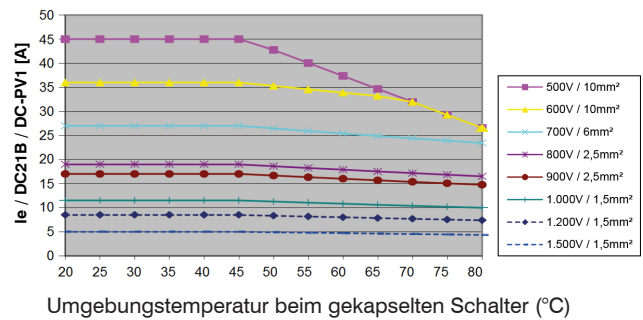

Schalter gekapselt LS25 PFL..., 4 Kontakte in Serie (A4x)

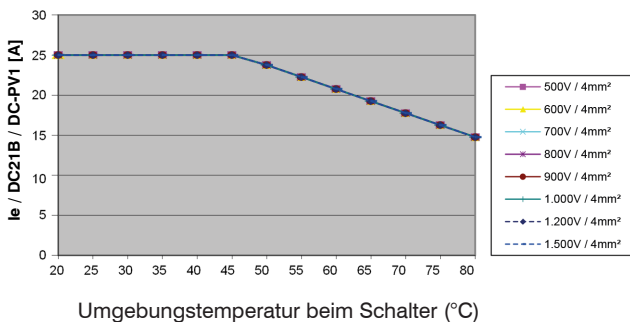

Schalter gekapselt LS25PFL..., 4 Kontakte in Serie + 2 parallel (A4+2)

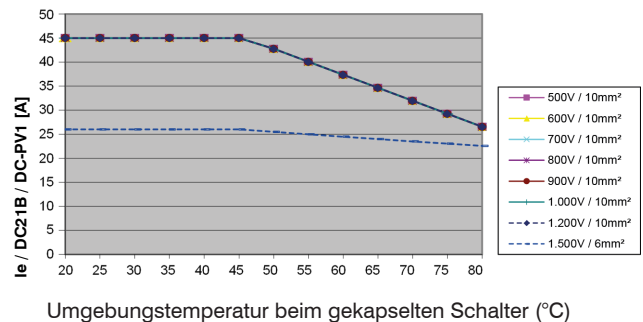

Technische Daten

Maximal zulässiger Strom, abhängig von Umgebungstemperatur und Anschlußquerschnitten

Schalter offen LS32..., 2 Kontakte in Serie (A2)

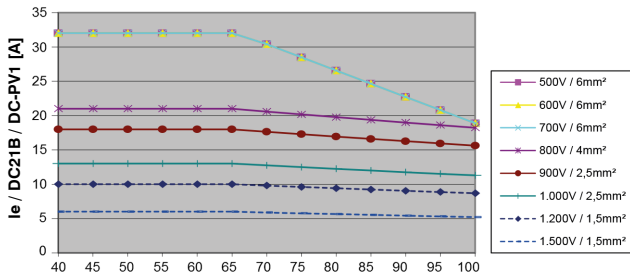

Umgebungstemperatur beim Schalter (°C)

Schalter offen LS32 ..., 2 Kontakte in Serie + 2 parallel (A2+2)

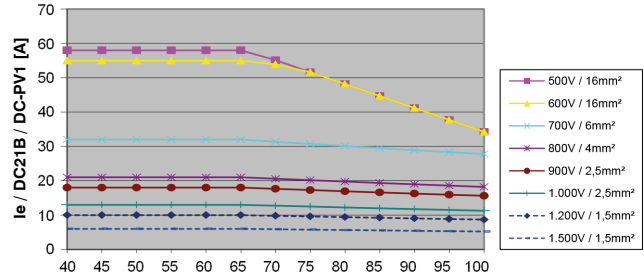

Umgebungstemperatur beim Schalter (°C)

Schalter offen LS32..., 4 Kontakte in Serie (A4x)

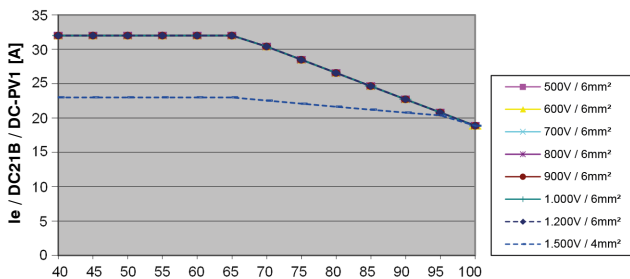

Umgebungstemperatur beim Schalter (°C)

Schalter offen LS32..., 4 Kontakte in Serie + 2 parallel (A4+2)

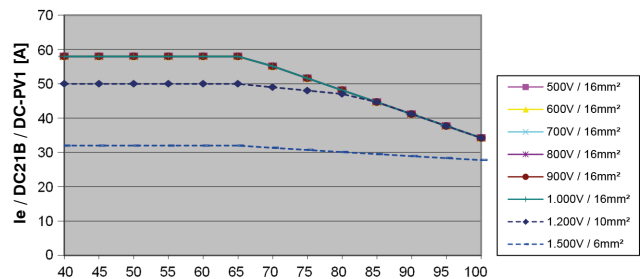

Umgebungstemperatur beim Schalter (°C)

Schalter gekapselt LS32 PFL..., 2 Kontakte in Serie (A2)

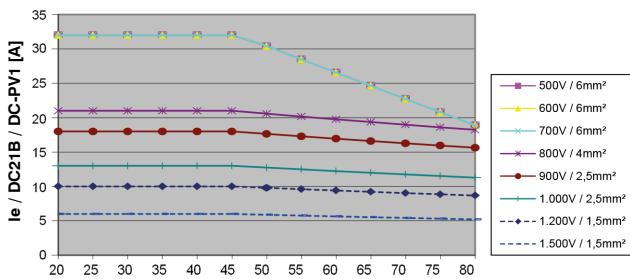

Umgebungstemperatur beim gekapselten Schalter (°C)

Schalter gekapselt LS32 PFL..., 2 Kontakte in Serie + 2 parallel (A2+2)

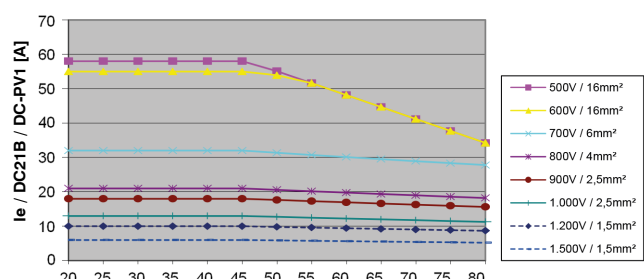

Umgebungstemperatur beim gekapselten Schalter (°C)

Schalter gekapselt LS32 PFL..., 4 Kontakte in Serie (A4x)

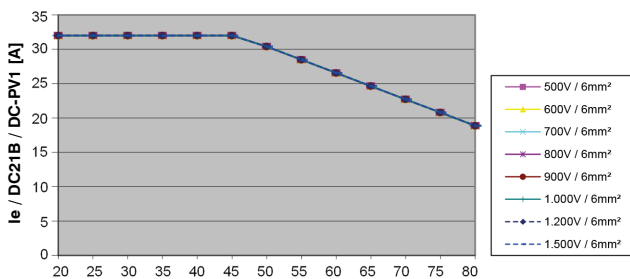

Umgebungstemperatur beim gekapselten Schalter (°C)

Schalter gekapselt LS32PFL..., 4 Kontakte in Serie + 2 parallel (A4+2)

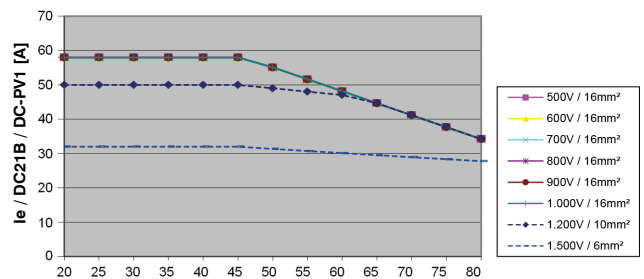

Umgebungstemperatur beim gekapselten Schalter (°C)

Technische Daten

Maximal zulässiger Strom, abhängig von Umgebungstemperatur und Anschlußquerschnitten

Schalter offen LS40..., 2 Kontakte in Serie (A2)

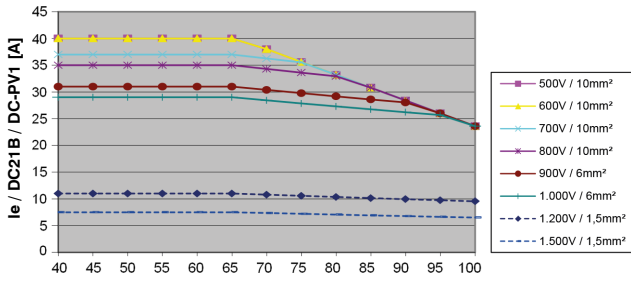

Umgebungstemperatur beim Schalter (°C)

Schalter offen LS40 ..., 2 Kontakte in Serie + 2 parallel (A2+2)

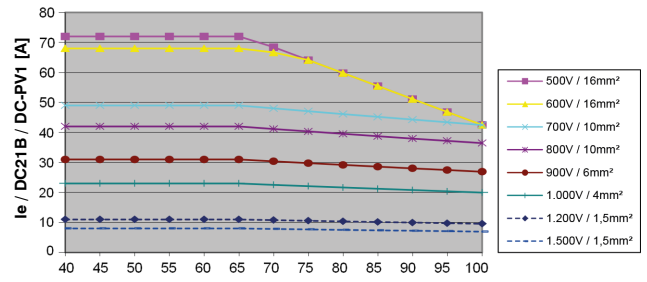

Umgebungstemperatur beim Schalter (°C)

Schalter offen LS40..., 4 Kontakte in Serie (A4x)

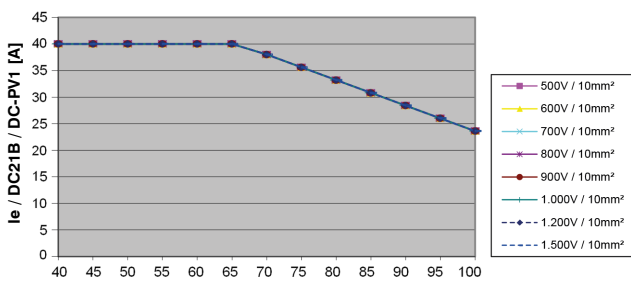

Umgebungstemperatur beim Schalter (°C)

Schalter offen LS32..., 4 Kontakte in Serie + 2 parallel (A4+2)

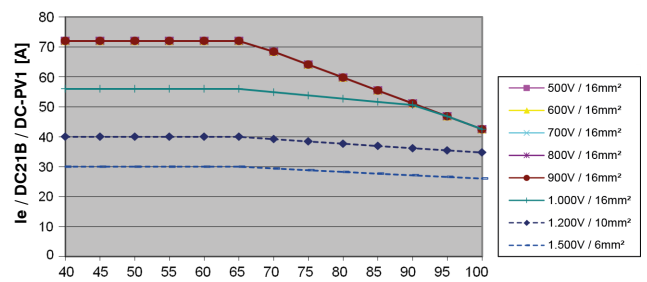

Umgebungstemperatur beim Schalter (°C)

Schalter gekapselt LS40 PFL..., 2 Kontakte in Serie (A2)

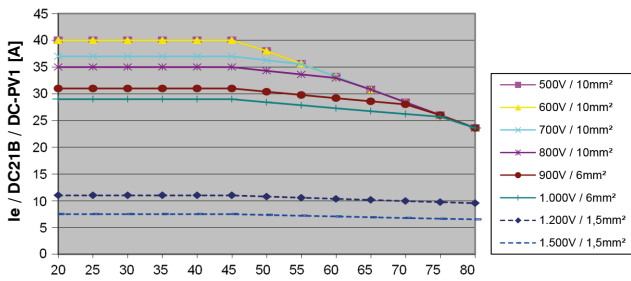

Umgebungstemperatur beim Schalter (°C)

Schalter gekapselt LS40 PFL..., 2 Kontakte in Serie + 2 parallel (A2+2)

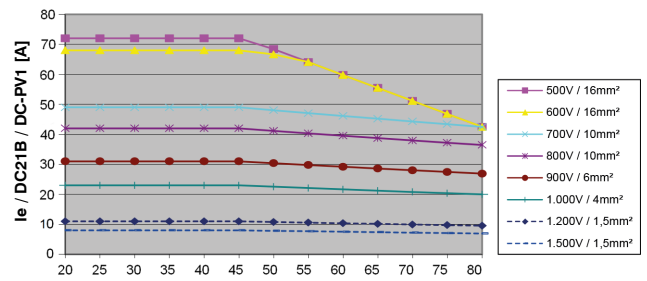

Umgebungstemperatur beim Schalter (°C)

Schalter gekapselt LS40 PFL..., 4 Kontakte in Serie (A4x)

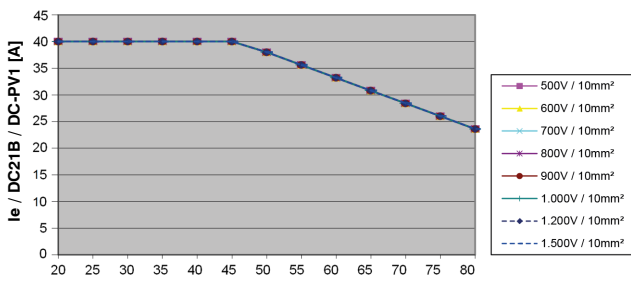

Umgebungstemperatur beim Schalter (°C)

Schalter gekapselt LS40 PFL..., 4 Kontakte in Serie + 2 parallel (A4+2)

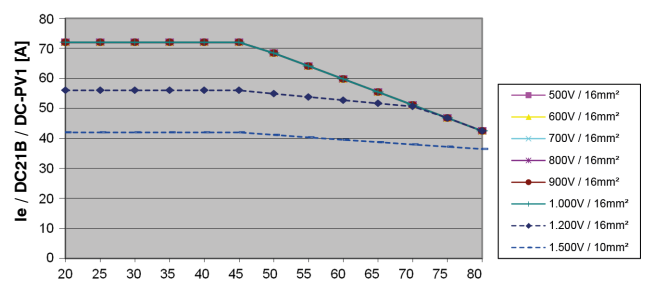

Umgebungstemperatur beim Schalter (°C)

Technische Daten

Maximal zulässiger Strom, abhängig von Umgebungstemperatur und Anschlußquerschnitten

Schalter offen LS55..., 2 Kontakte in Serie (A2)

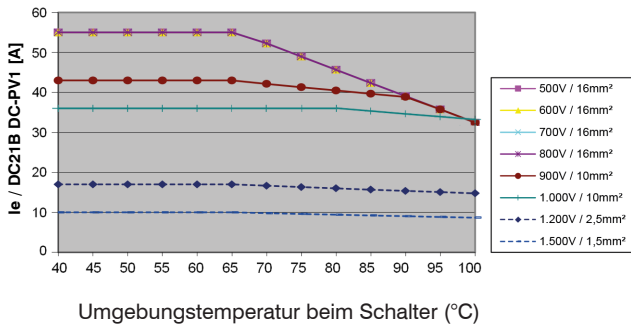

Schalter offen LS55 ..., 2 Kontakte in Serie + 2 parallel (A2+2)

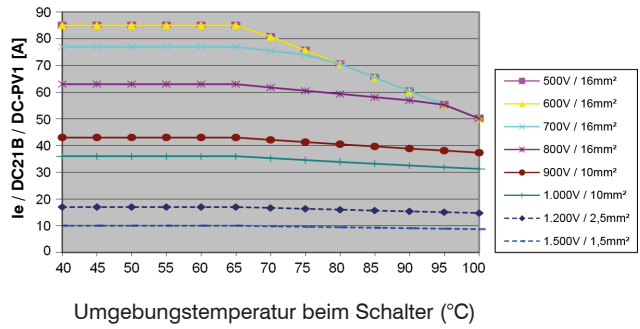

Schalter offen LS55..., 4 Kontakte in Serie (A4x)

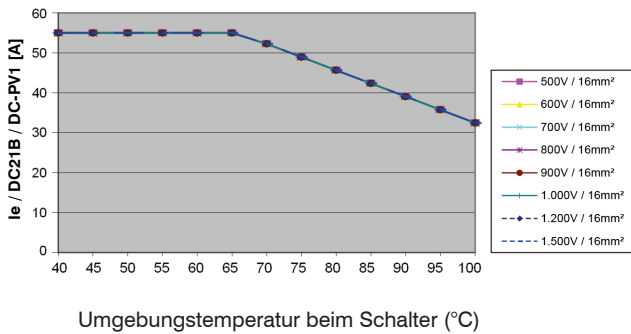

Schalter offen LS55 ..., 4 Kontakte in Serie + 2 parallel (A4+2)

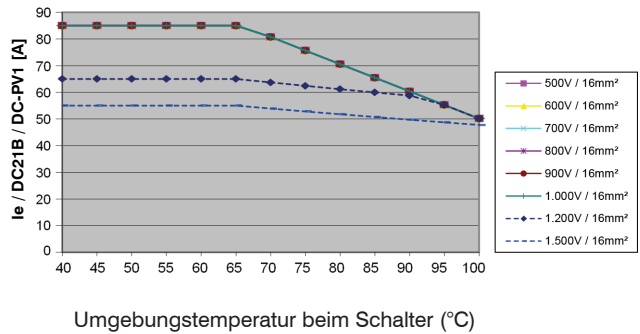

Schalter gekapselt LS55 PFL..., 2 Kontakte in Serie (A2)

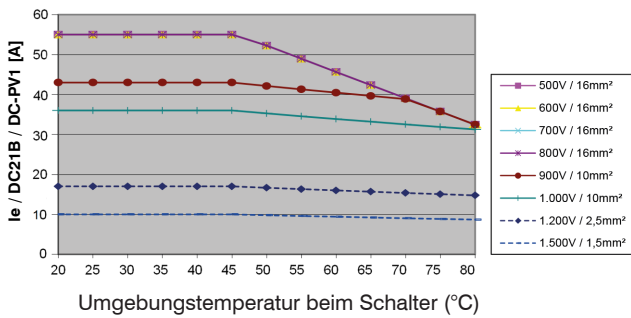

Schalter gekapselt LS55 PFL..., 2 Kontakte in Serie + 2 parallel (A2+2)

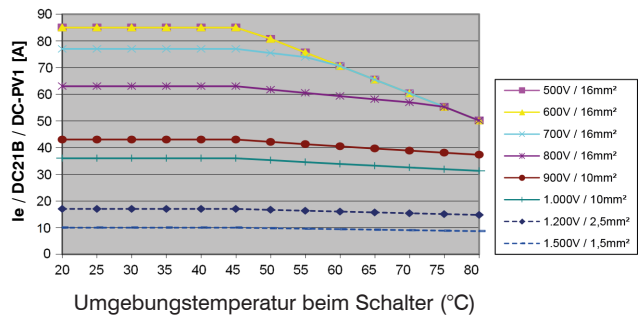

Schalter gekapselt LS55 PFL..., 4 Kontakte in Serie (A4x)

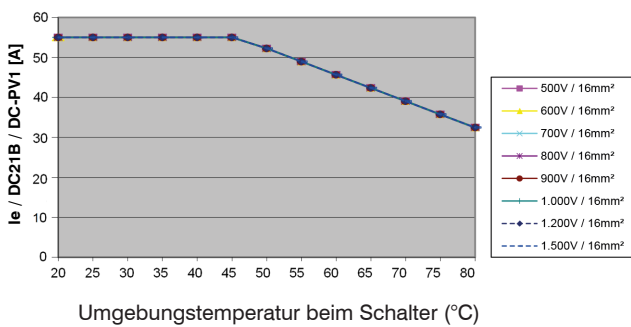

Schalter gekapselt LS55 PFL..., 4 Kontakte in Serie + 2 parallel (A4+2)

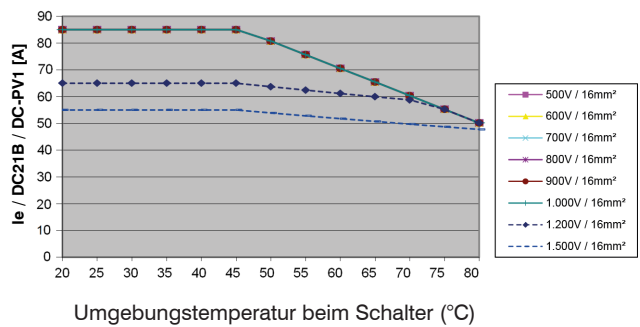

Abmessungen

LS16 E., LS25 E., LS32 E., LS38E.,
..A2

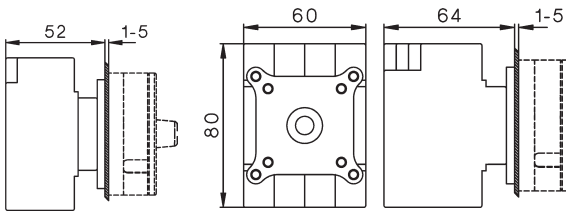

LS16 E., LS25 E., LS32 E., LS38E.,
..A6, ..A8, ..A3+2, ..A4+2

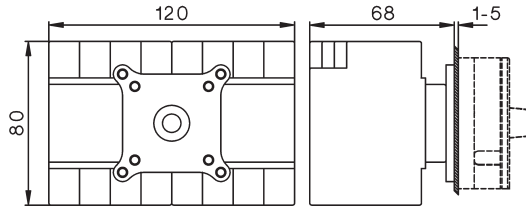

LS... +VW"x"
Verlängerte Schalterwelle

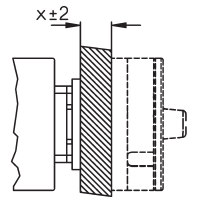

LS40 E., LS55 E..
..A2, ..A2+2, ..A4

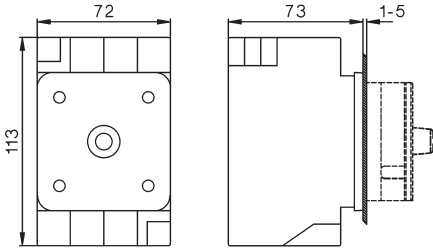

LS40 E., LS55 E..
..A6, ..A8, ..A3+2, ..A4+2

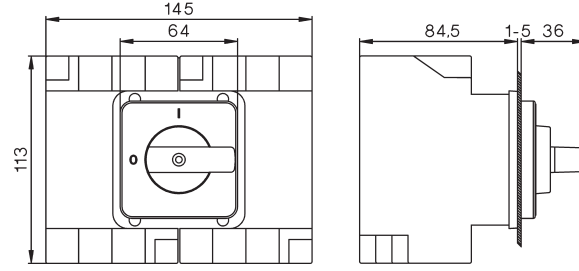

Bohrplan
Montageschraube
S3631N M=1,2-1,4 Nm

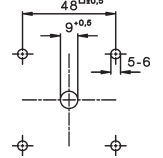

Schild 64r
Griff

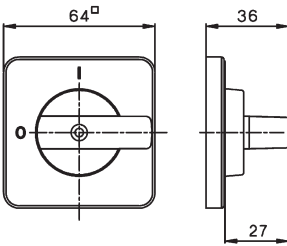

Sperrvorrichtung SV1

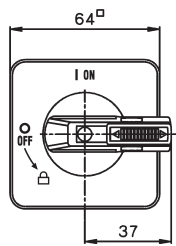

Sperrvorrichtung SV4

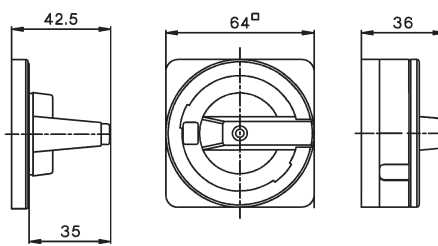

LS16 Z., LS25 Z., LS32 Z., LS38Z.,
..A2

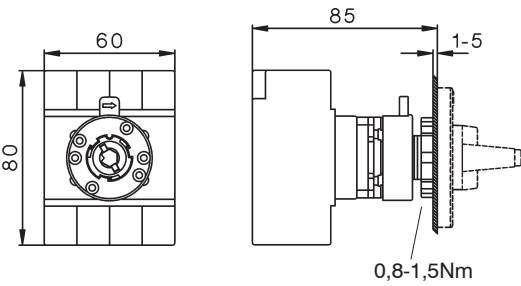

..A2+2, ..A4

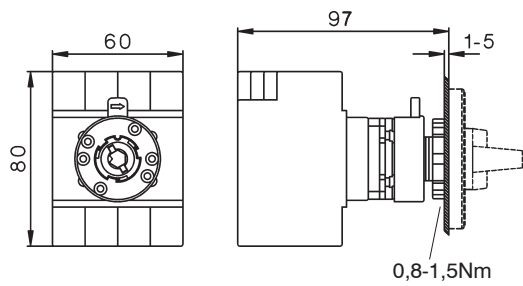

Bohrplan

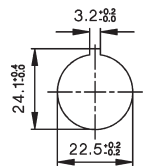

Schild 48r
Griff

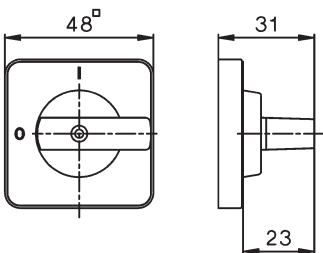

Sperrvorrichtung SV1

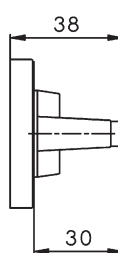
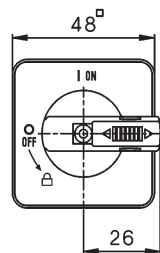

Abmessungen

LS16 Z., LS25 Z., LS32 Z., LS38 Z.,
..A6, ..A8, ..A3+2, ..A4+2

LS.. ZO..

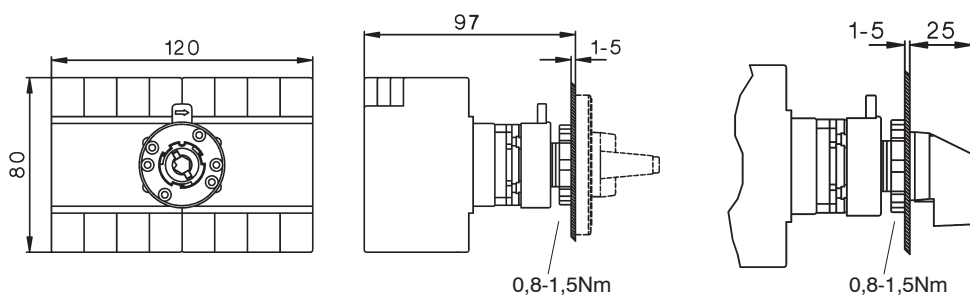

LS16 VZV., LS25 VZV., LS32 VZV., LS38 VZV.,
..A2, ..A2+2, ..A4

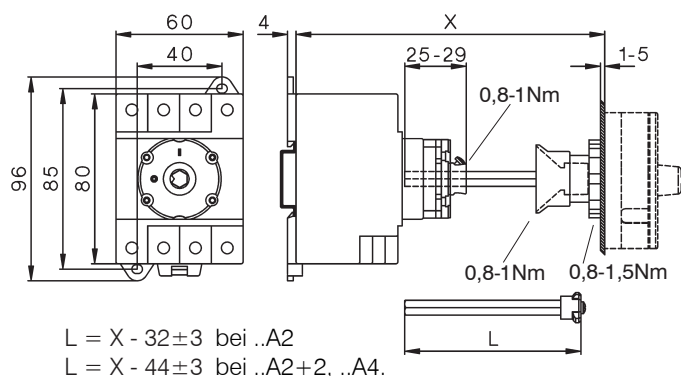

$$L = X - 32 \pm 3 \text{ bei } \dots A2$$

$$L = X - 44 \pm 3 \text{ bei } \dots A2+2, \dots A4.$$

Lieferlänge bei: ..A2
 $X_{max} = 182$, $L = 150$
 $(X_{min} = 77)$

Lieferlänge bei: ..A2+2, ..A4.
 $X_{max} = 194$, $L = 150$
 $(X_{min} = 89)$

größere X-Maße auf Anfrage

LS16 VZV., LS25 VZV., LS32 VZV., LS38 VZV.,
..A6, ..A8, ..A3+2, ..A4+2

Bohrplan

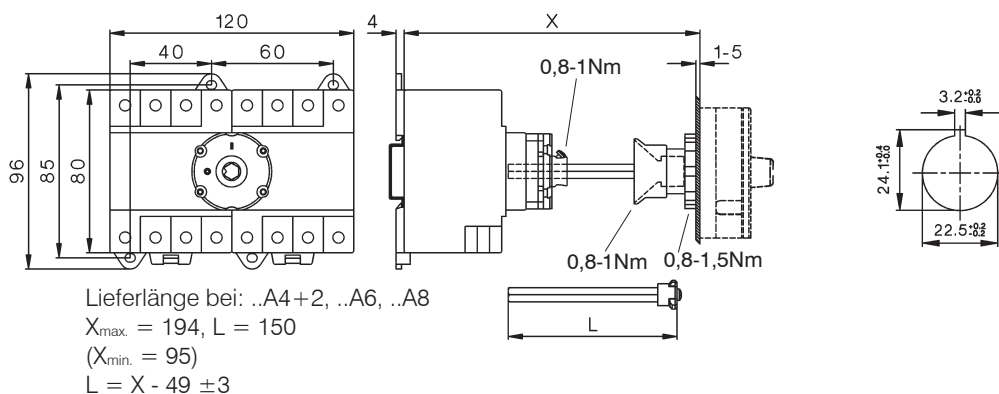

Lieferlänge bei: ..A4+2, ..A6, ..A8
 $X_{max} = 194$, $L = 150$
 $(X_{min} = 95)$
 $L = X - 49 \pm 3$

LS40 VZV., LS55 VZV.,
..A2, ..A2+2, ..A4

LS40 VZV., LS55 VZV.,
..A6, ..A8, ..A3+2, ..A4+2

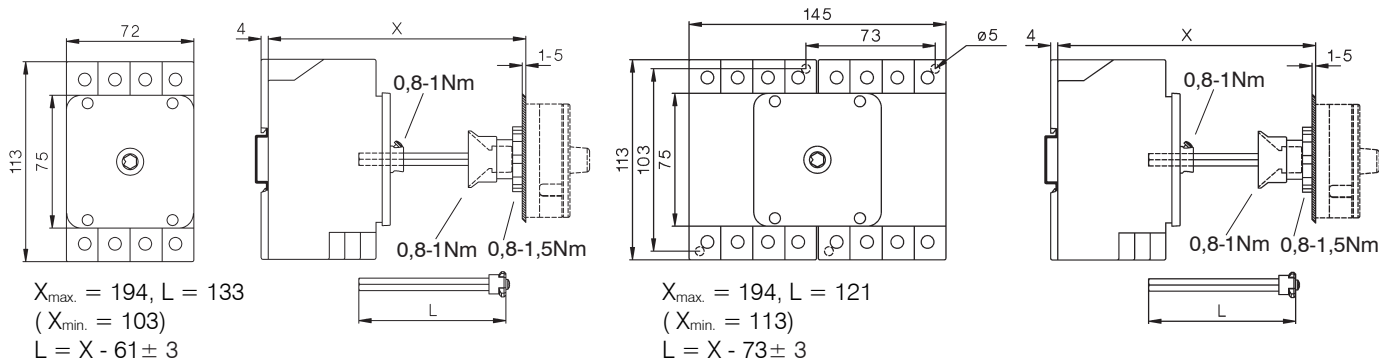

$X_{max} = 194$, $L = 133$
 $(X_{min} = 103)$
 $L = X - 61 \pm 3$

$X_{max} = 194$, $L = 121$
 $(X_{min} = 113)$
 $L = X - 73 \pm 3$

Abmessungen

LS16 SMA..., LS25 SMA..., LS32 SMA..., LS38 SMA...,
..A2 ..

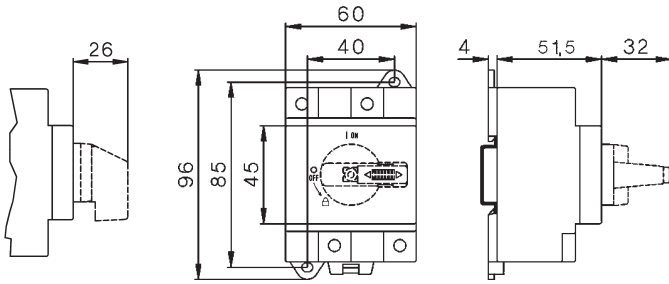

A2+2, ..A4

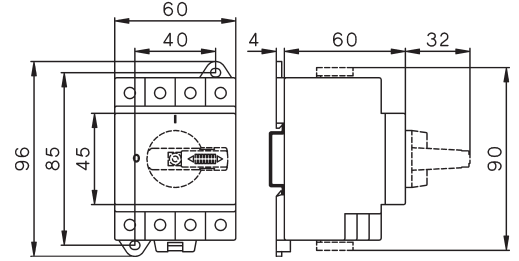

LS40 SMA..., LS55 SMA..
..A2, ..A2+2, ..A4

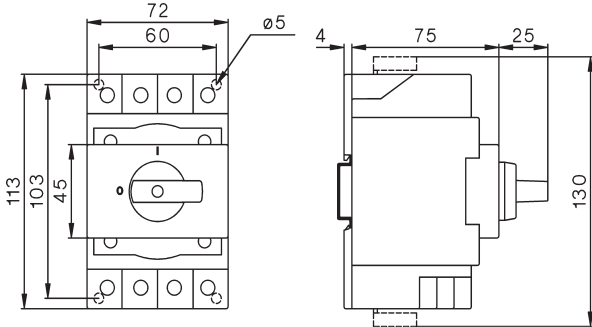

LS40 SMA..., LS55 SMA..
..A6, ..A8, ..A3+2, ..A4+2

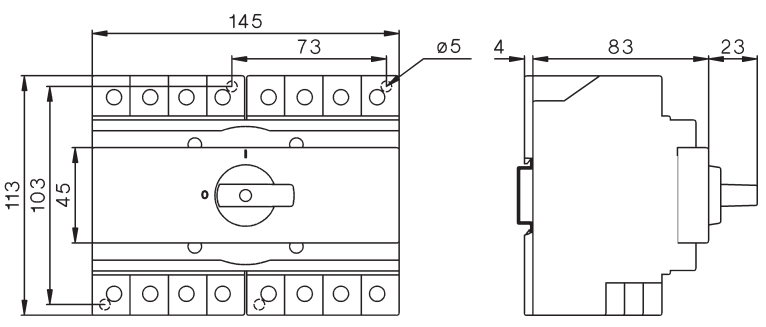

LS16 SMA..., LS25 SMA..., LS32 SMA..., LS38 SMA...,
..A6, ..A8, ..A3+2, ..A4+2

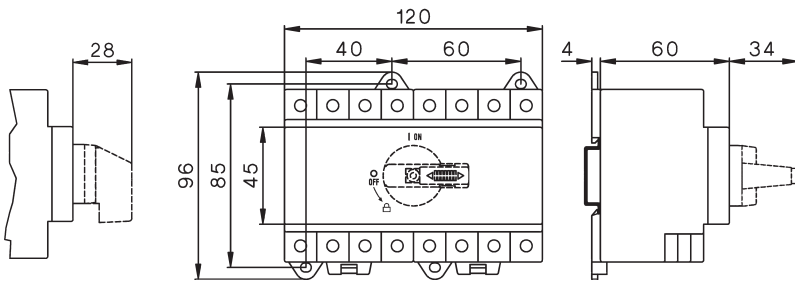

LS.. SMAH1.. mit niedrigem Griff
A2 +SV1N

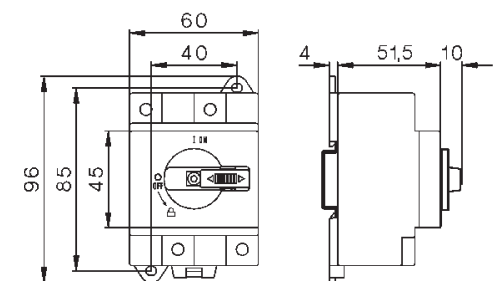

LS16 SMAH1..., LS25 SMAH1..., LS32 SMAH1..., LS38 SMAH1..
A2+2 +SV1N, A4 +SV1N mit niedrigem Griff

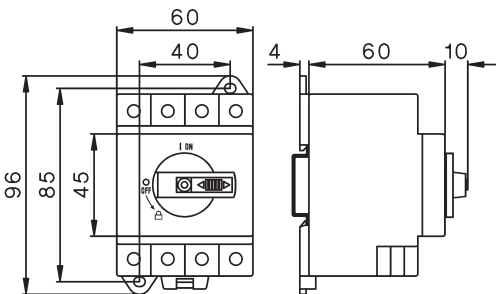

mit niedrigem Griff
A4+2 +SV1N, A6 +SV1N, A8 +SV1N

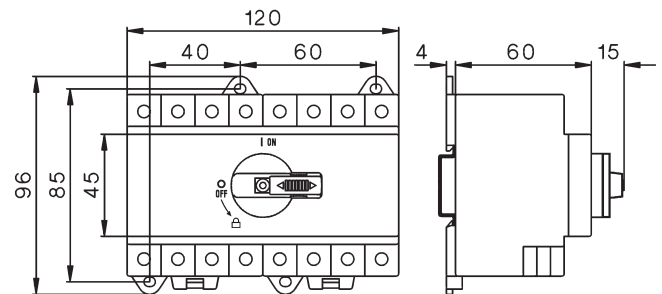

Abmessungen

LS16 PFL..., LS25 PFL..., LS32 PFL..., LS38 PFL..
..A2, ..A2+2, ..A4

Hauptschalter (versperrbar)
LS..PFLH4 A..

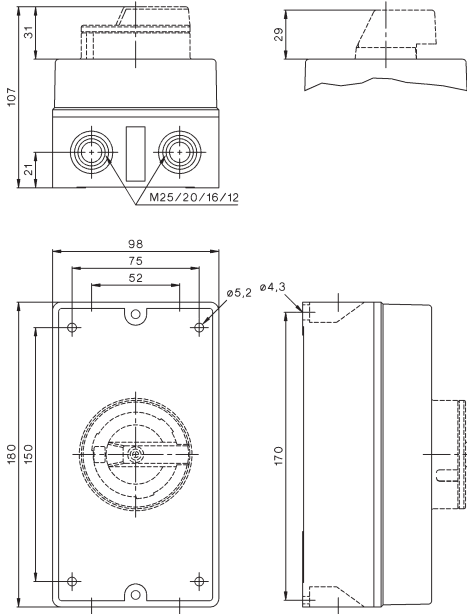

LS16 PFL..., LS25 PFL..., LS32 PFL..., LS38 PFL..
..A2, ..A2+2, ..A4
+ M25

Hauptschalter (versperrbar)
LS..PFLH4 A..

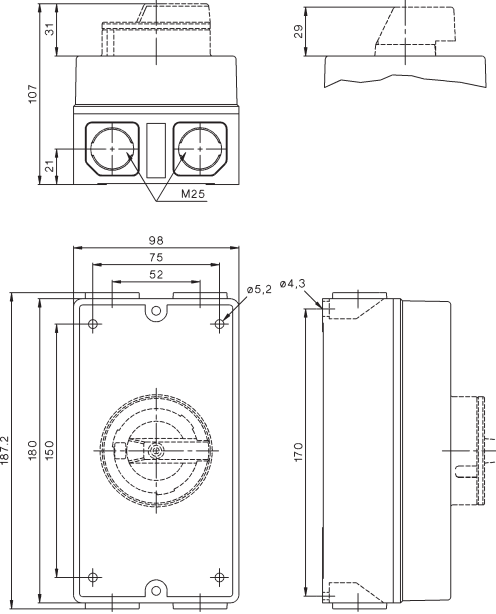

LS16 PFL..., LS25 PFL..., LS32 PFL..., LS38 PFL...,
..A6, ..A8, ..A3+2, ..A4+2
Hauptschalter (versperrbar)
LS..PFLH4 A..

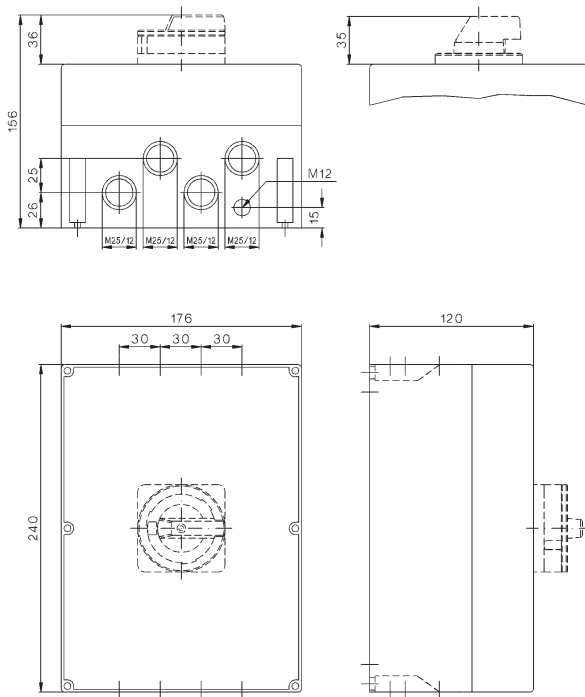

LS40 PFL..., LS55 PFL..
..A2, ..A4, ..A6, ..A8, ..A2+2, ..A3+2, ..A4+2

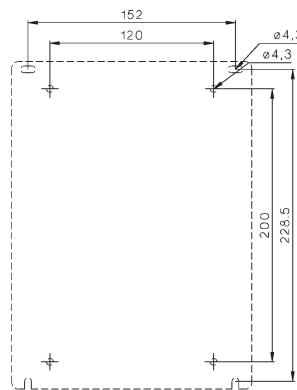

Isolierte Verbinder LSV-.. für Serien- und Parallelschaltung von Kontakten:

LS16.., LS25.., LS32.., LS38..

LSV-B1-1



und LSV-B1-2



LS.. E A2+2

LSV-B1-1

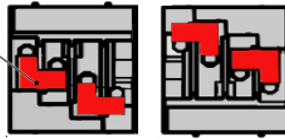

LS.. E A3+2

LSV-B1-1

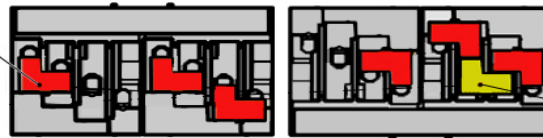

LSV-B1-2

LS.. V A4+2U

LSV-B1-1

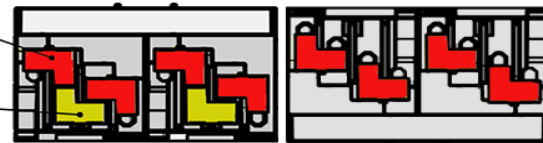

LSV-B1-2

LS40.., LS55..

LSV-B2-1



+



= LSV-B2



LS.. E A2+2

LSV-B2-1

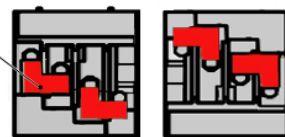

LS.. E A3+2

LSV-B2-1

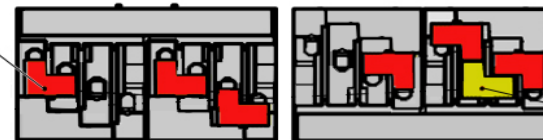

LSV-B2

LS.. V A4+2U

LSV-B2-1



LSV-B2

