

# Index

Page

	Main Switches for Panel Mounting	280
	Changover Switches for Panel Mounting	281
	Main Switches for Single Hole Mounting	281
	Main Switches for Base Mounting with Door Clutch	282
	Main Switches-Emergency-Stop for Panel Mounting	286
	Changover Switches-Emergency-Stop for Panel Mounting	287
	Main Switches-Emergency-Stop for Single Hole Mounting	287
	Main Switches-Emergency-Stop for Base Mounting	288
	Main Switches-Emergency-Stop for Distribution Boards	290
	Changover Switches-Emergency-Stop for Distribution Boards	290
	Maintenance and Safety Switches, in Plastic Enclosure	291
	Changover Safety Switches, in Plastic Enclosure	291
	Switch Disconnectors for Panel Mounting	292
	Switch Disconnectors for Single Hole Mounting	293
	Switch Disconnectors for Base Mounting	293
	Switch Disconnectors for Distribution Boards	295
	Switch Disconnectors in Plastic Enclosure	296
	Add-on modules	297
	Technical Data	299
	Dimensions	300

Contactors, Motor-Starters

Circuit Breakers

Manual Motor-Starters

Switches

AC-Main Switches

DC-Switch Disconnectors

Push Buttons

Representatives, Suppliers

Ratings								Panel mounting 4 hole mount. IP66	Single hole mount. Ø22,5mm IP66				
Type	Rated current			Motor			Plate Switch						
	Therm. I <sub>th open</sub> A	AC21 A	at U <sub>e</sub> V	AC3 3~400V kW	AC23 3~400V A	AC23 3~400V kW		EH4	EHN4	EHN1	Z	ZHN1	ZH1
LTS20	20	20	690	5,5	16	7,5	48□	LTS20 E <sup>1)</sup> ..			LTS20 Z <sup>1)</sup> ..		
LTS25	25	25	690	7,5	20	10	48□	LTS25 E <sup>1)</sup> ..			LTS25 Z <sup>1)</sup> ..		
LTS32	32	32	690	11	25	12,5	48□	LTS32 E <sup>1)</sup> ..			LTS32 Z <sup>1)</sup> ..		
LTS40	40	40	690	15	32	16	48□	LTS40 E <sup>1)</sup> ..			LTS40 Z <sup>1)</sup> ..		
LTS63	63	63	690	18,5	45	22	48□	LTS63 E <sup>1)</sup> ..			-		
LTS80	80	80	690	18,5	45	22	48□	LTS80 E <sup>1)</sup> ..			-		
LTS85	85	85	690	22	60	30	64□	LTS85 E <sup>1)</sup> ..			-		
LTS100	100	100	690	30	72	37	64□	LTS100 E <sup>1)</sup> ..			-		
LTS125	125	125	690	37	85	45	64□	LTS125 E <sup>1)</sup> ..			-		
LT160	160	160	690	45	110	55	88□	LT160 E <sup>1)</sup> ..			-		

### Switch disconnecter LT.. 20 - 160A

Switch disconnectors are to be used as an ON-OFF-switch where a high breaking capacity with high contact pressure and in fact better short circuit behavior is necessary. These applications are:

**Main switches** according to IEC/EN 60204 respectively VDE0113 with interlocking device, terminal protection and restrictive contacts.

**Switch disconnectors** according to IEC/EN 60947-3 and VDE 0660 part 107 with break distance for 690V.

**Motor switches** 3-pole or 4-pole; according to IEC/EN 60947-3 respectively VDE 0660 part 107, motor switches series LT are dimensioned for switching high rated current AC3 and AC23A.

### Switch program

On-Off Switch 3-pole	.. ...	A3
On-Off Switch 4-pole	.. ...	A4
On-Off Switch 6-pole	.. ...	A6
On-Off Switch 8-pole	.. ...	A8
Changeover Switches 3-pole	.. ...	U3
Changeover Switches 4-pole	.. ...	U4
On-Off Switch 3-pole	.. ...	T300 (for LT160)
On-Off Switch 4-pole	.. ...	T400 (for LT160)

### Main switches and Main switches with Emergency-Stop function

According to standards IEC/EN60204 or VDE0113, all electrical equipment of industrial machines must be equipped with a main switch. This must permit disconnection of all the electrical equipment during cleaning, maintenance and repair work, and other extended periods when it is stationary. In case of two or more main switches, an interlock system must be used. It is recommended to use a multiple-pole main switch (cam switch).

**Main switches** have to correspond to:

- Switch disconnecter according to IEC/EN 60947-3 and VDE 0660 part 107 for utilization category AC23-B or DC-23B.
- Disconnectors are selected according to thermal rated current. They must possess a contact that ensures load switching via the contactors (see switching program A3-10). This contact must have a sufficient AC15 switching capacity.
- The interruption capacity of the switch must equal or exceed the locked rotor current of the largest motor plus the total current of all other electrical equipment in the circuit.

Requirements:

Interruption of the electrical equipment, with only on and off positions clearly marked with O and I.

It must be lockable in the off setting.

The line terminals of the main switch must be protected according to utilization category IP2X.

Colour of handle black or grey.

**Main switches with Emergency-Off function** are additional supplied with red handles and contrasting yellow escutcheon plates.

1) Main Switches (H1/H4 Main Switches-Emergency-Stop (HN1/HN4))  
Switch Disconnectors (without H(N)1/4)

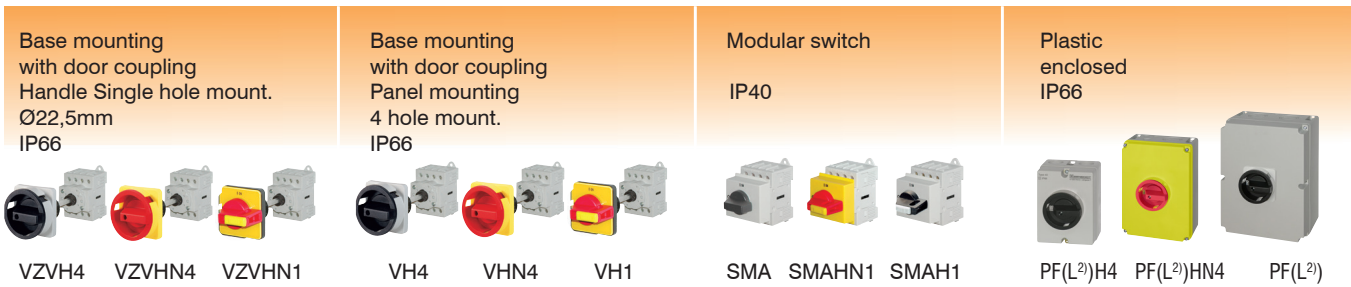

LTS20 VZV <sup>(1)</sup> ..	LTS20 V <sup>(1)</sup> ..	LTS20 SMA <sup>(1)</sup> ..	LTS20 PF(L <sup>2</sup> ) <sup>(1)</sup> ..
LTS25 VZV <sup>(1)</sup> ..	LTS25 V <sup>(1)</sup> ..	LTS25 SMA <sup>(1)</sup> ..	LTS25 PF(L <sup>2</sup> ) <sup>(1)</sup> ..
LTS32 VZV <sup>(1)</sup> ..	LTS32 V <sup>(1)</sup> ..	LTS32 SMA <sup>(1)</sup> ..	LTS32 PF(L <sup>2</sup> ) <sup>(1)</sup> ..
LTS40 VZV <sup>(1)</sup> ..	LTS40 V <sup>(1)</sup> ..	LTS40 SMA <sup>(1)</sup> ..	LTS40 PF(L <sup>2</sup> ) <sup>(1)</sup> ..
LTS63 VZV <sup>(1)</sup> ..	LTS63 V <sup>(1)</sup> ..	LTS63 SMA <sup>(1)</sup> ..	LTS63 PFL <sup>(1)</sup> ..
LTS80 VZV <sup>(1)</sup> ..	LTS80 V <sup>(1)</sup> ..	LTS80 SMA <sup>(1)</sup> ..	LTS80 PFL <sup>(1)</sup> ..
LTS85 VZV <sup>(1)</sup> ..	LTS85 V <sup>(1)</sup> ..	LTS85 SMA <sup>(1)</sup> ..	LTS85 PFL <sup>(1)</sup> ..
LTS100 VZV <sup>(1)</sup> ..	LTS100 V <sup>(1)</sup> ..	LTS100 SMA <sup>(1)</sup> ..	LTS100 PFL <sup>(1)</sup> ..
LTS125 VZV <sup>(1)</sup> ..	LTS125 V <sup>(1)</sup> ..	LTS125 SMA <sup>(1)</sup> ..	LTS125 PFL <sup>(1)</sup> ..
-	LT160 V <sup>(1)</sup> ..	-	LT160 PF <sup>(1)</sup> .. <sup>3)</sup>

### Approvals

Area	USA, Canada / UL	Europe	Russia / EAC	CB/CCA-Certificates
Type				

**Switch disconnecter** (UL-Listed as MANUAL MOTOR CONTROLLER and suitable as MOTOR DISCONNECT)

LTS20	o	/	o	o
LTS25	o	/	o	o
LTS32	o	/	o	o
LTS40	o	/	o	o
LTS63	o	/	o	o
LTS80	o	/	o	o
LTS85	o	/	-	-
LTS100	o	/	-	-
LTS125	o	/	-	-
LT160	o	/	-	o

o in standard version approved  
/ No testing required CE  
x in test  
- Not provided for test till now









### Terminal screws

Devices	Kind of connection		Tightening torque		Protection class of terminals <sup>4)</sup>
	screw with clamp box	Screwdriver	Nm	lb. inch	
<b>Switch Disconnectors</b>					
LTS20, LTS25	M3,5	Pz2	1,7 - 2,3	15 - 20	IP20
LTS32, LTS40	M5	Pz2	2,8 - 4	25 - 35	IP20
LTS63, LTS80	M6	Pz3	1,7 - 4,5	15 - 40	IP20
LTS85, LTS100, LTS125					
LT160	M10		14	124	IP20

1) Main Switches (H1/H4 Main Switches-Emergency-Stop (HN1/HN4)) and Switch Disconnectors (without H(N)1/4)  
 2) PFL... larger enclosure  
 3) IP. Type..  
 4) Protection degree of the terminals with connected insulated conductor. Additional protection with terminal cover (KLAD).

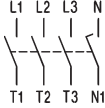
Contactors, Motor-Starters  
 Circuit Breakers  
 Manual Motor-Starters  
 Switches  
 AC-Main Switches  
 DC-Switch Disconnecter  
 Push Buttons  
 Representatives, Suppliers

## Main Switches for Panel Mounting, lockable IP66, Type 3R

	max. padlocks	AC21 690V	AC23 3x400V	Plate	Type	Pack pcs.	Weight kg/pcs.
<b>3-pole, padlock device SV1</b> 							
		20A	<b>7,5kW</b>	48 □ <sup>1)</sup>	LTS20 EH1 A3	1	0,15
		25A	<b>10kW</b>	48 □ <sup>1)</sup>	LTS25 EH1 A3	1	0,15
		32A	<b>12,5kW</b>	48 □ <sup>1)</sup>	LTS32 EH1 A3	1	0,15
		40A	<b>16kW</b>	48 □ <sup>1)</sup>	LTS40 EH1 A3	1	0,15
		63A	<b>22kW</b>	48 □ <sup>1)</sup>	LTS63 EH1 A3	1	0,17
		80A	<b>22kW</b>	48 □ <sup>1)</sup>	LTS80 EH1 A3	1	0,17
<b>4-pole, padlock device SV1</b> 							
		20A	<b>7,5kW</b>	48 □ <sup>1)</sup>	LTS20 EH1 A4	1	0,19
		25A	<b>10kW</b>	48 □ <sup>1)</sup>	LTS25 EH1 A4	1	0,19
		32A	<b>12,5kW</b>	48 □ <sup>1)</sup>	LTS32 EH1 A4	1	0,19
		40A	<b>16kW</b>	48 □ <sup>1)</sup>	LTS40 EH1 A4	1	0,19
		63A	<b>22kW</b>	48 □ <sup>1)</sup>	LTS63 EH1 A4	1	0,21
		80A	<b>22kW</b>	48 □ <sup>1)</sup>	LTS80 EH1 A4	1	0,21
<b>3-pole, padlock device SV4(34)</b> 							
		20A	<b>7,5kW</b>	64 □ <sup>2)</sup>	LTS20 EH4 A3	1	0,17
		25A	<b>10kW</b>	64 □ <sup>2)</sup>	LTS25 EH4 A3	1	0,17
		32A	<b>12,5kW</b>	64 □ <sup>2)</sup>	LTS32 EH4 A3	1	0,17
		40A	<b>16kW</b>	64 □ <sup>2)</sup>	LTS40 EH4 A3	1	0,17
		63A	<b>22kW</b>	64 □ <sup>2)</sup>	LTS63 EH4 A3	1	0,19
		80A	<b>22kW</b>	64 □ <sup>2)</sup>	LTS80 EH4 A3	1	0,19
		80A	<b>30kW</b>	64 □ <sup>2)</sup>	LTS85 EH4 A3	1	0,39
		100A	<b>37kW</b>	64 □ <sup>2)</sup>	LTS100 EH4 A3	1	0,39
		125A	<b>45kW</b>	64 □ <sup>2)</sup>	LTS125 EH4 A3	1	0,39
		160A	<b>55kW</b>	88 □	LT160 EH34 T300	1	1,16
<b>4-pole, padlock device SV4(34)</b> 							
		20A	<b>7,5kW</b>	64 □ <sup>2)</sup>	LTS20 EH4 A4	1	0,20
		25A	<b>10kW</b>	64 □ <sup>2)</sup>	LTS25 EH4 A4	1	0,20
		32A	<b>12,5kW</b>	64 □ <sup>2)</sup>	LTS32 EH4 A4	1	0,20
		40A	<b>16kW</b>	64 □ <sup>2)</sup>	LTS40 EH4 A4	1	0,20
		63A	<b>22kW</b>	64 □ <sup>2)</sup>	LTS63 EH4 A4	1	0,23
		80A	<b>22kW</b>	64 □ <sup>2)</sup>	LTS80 EH4 A4	1	0,23
		80A	<b>30kW</b>	64 □ <sup>2)</sup>	LTS85 EH4 A4	1	0,44
		100A	<b>37kW</b>	64 □ <sup>2)</sup>	LTS100 EH4 A4	1	0,44
		125A	<b>45kW</b>	64 □ <sup>2)</sup>	LTS125 EH4 A4	1	0,44
		160A	<b>55kW</b>	88 □	LT160 EH34 T400	1	1,55

**Add-on modules** see page 297







**Extended Switch Shaft for switches for panel mounting** type suffix +VW"x"

x = panel thickness



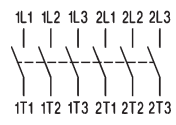

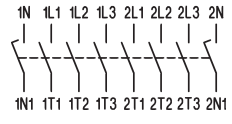

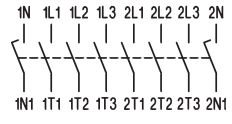
1) Types with padlock device 64 □ type suffix **64**, ordering example: LTS32 EH1**64** A3, on request

2) Types with padlock device 88 □ type suffix **88**, ordering example: LTS32 EH4**88** A3, on request



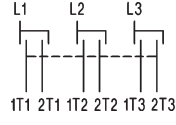

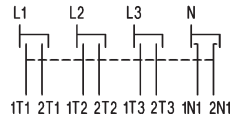

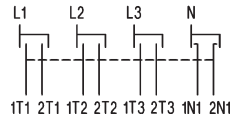
## Main Switches for Panel Mounting, lockable IP66, Type 3R

		max. padlocks	AC21 690V	AC23 3x400V	Plate	Type	Pack pcs.	Weigh kg/pcs.
<b>6-pole, padlock device SV4</b> 								
			20A	<b>7,5kW</b>	64 □	LTS20 EH4 A6	1	0,30
			25A	<b>10kW</b>	64 □	LTS25 EH4 A6	1	0,30
			32A	<b>12,5kW</b>	64 □	LTS32 EH4 A6	1	0,30
			40A	<b>16kW</b>	64 □	LTS40 EH4 A6	1	0,30
			63A	<b>22kW</b>	64 □	LTS63 EH4 A6	1	0,34
			80A	<b>22kW</b>	64 □	LTS80 EH4 A6	1	0,34
<b>8-pole, padlock device SV4</b> 								
			20A	<b>7,5kW</b>	64 □	LTS20 EH4 A8	1	0,38
			25A	<b>10kW</b>	64 □	LTS25 EH4 A8	1	0,38
			32A	<b>12,5kW</b>	64 □	LTS32 EH4 A8	1	0,38
			40A	<b>16kW</b>	64 □	LTS40 EH4 A8	1	0,38
			63A	<b>22kW</b>	64 □	LTS63 EH4 A8	1	0,42
			80A	<b>22kW</b>	64 □	LTS80 EH4 A8	1	0,42

## Changeover Switches with padlockdevice for Panel Mounting, lockable IP66

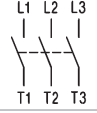
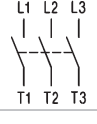

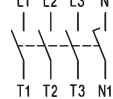
<b>3-pole, padlock device SV4</b> 								
			20A	<b>7,5kW</b>	64 □	LTS20 EH4 U3	1	0,30
			25A	<b>10kW</b>	64 □	LTS25 EH4 U3	1	0,30
			32A	<b>12,5kW</b>	64 □	LTS32 EH4 U3	1	0,30
			40A	<b>16kW</b>	64 □	LTS40 EH4 U3	1	0,30
			63A	<b>22kW</b>	64 □	LTS63 EH4 U3	1	0,34
<b>4-pole, padlock device SV4</b> 								
			20A	<b>7,5kW</b>	64 □	LTS20 EH4 U4	1	0,38
			25A	<b>10kW</b>	64 □	LTS25 EH4 U4	1	0,38
			32A	<b>12,5kW</b>	64 □	LTS32 EH4 U4	1	0,38
			40A	<b>16kW</b>	64 □	LTS40 EH4 U4	1	0,38
			63A	<b>22kW</b>	64 □	LTS63 EH4 U4	1	0,42

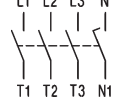
## Main Switches for Single Hole Mounting IP66, Type 4X

		max. padlocks	AC21 690V	AC23 3x400V	Plate	Type	Pack pcs.	Weigh kg/pcs.
<b>3-pole, padlock device SV1</b> 								
			20A	<b>7,5kW</b>	48 □	LTS20 ZH1 A3	1	0,16
			25A	<b>10kW</b>	48 □	LTS25 ZH1 A3	1	0,16
			32A	<b>12,5kW</b>	48 □	LTS32 ZH1 A3	1	0,16
			40A	<b>16kW</b>	48 □	LTS40 ZH1 A3	1	0,16
<b>4-pole, padlock device SV1</b> 								
			20A	<b>7,5kW</b>	48 □	LTS20 ZH1 A4	1	0,20
			25A	<b>10kW</b>	48 □	LTS25 ZH1 A4	1	0,20
			32A	<b>12,5kW</b>	48 □	LTS32 ZH1 A4	1	0,20
			40A	<b>16kW</b>	48 □	LTS40 ZH1 A4	1	0,20

Add-on modules see page 297

Main Switches, Base Mounting with Door Clutch for Single-Hole Mounting  
 Depth X is adjustable (delivered with X<sub>max</sub> see below), IP66,  Type 4X

	max. padlocks	AC21 690V	AC23 3x400V	Plate	Type	Pack pcs.	Weight kg/pcs.
<b>3-pole, padlock device SV4</b> 							
		20A	<b>7,5kW</b>	64 □	LTS20 VZVH4 A3	1	0,19
		25A	<b>10kW</b>	64 □	LTS25 VZVH4 A3	1	0,19
		32A	<b>12,5kW</b>	64 □	LTS32 VZVH4 A3	1	0,19
		40A	<b>16kW</b>	64 □	LTS40 VZVH4 A3	1	0,19
		63A	<b>22kW</b>	64 □	LTS63 VZVH4 A3	1	0,22
		80A	<b>22kW</b>	64 □	LTS80 VZVH4 A3	1	0,22
		85A	<b>30kW</b>	64 □	LTS85 VZVH4 A3	1	0,40
		100A	<b>37kW</b>	64 □	LTS100 VZVH4 A3	1	0,40
		125A	<b>45kW</b>	64 □	LTS125 VZVH4 A3	1	0,40
<b>4-pole, padlock device SV4</b> 							
		20A	<b>7,5kW</b>	64 □	LTS20 VZVH4 A4	1	0,20
		25A	<b>10kW</b>	64 □	LTS25 VZVH4 A4	1	0,20
		32A	<b>12,5kW</b>	64 □	LTS32 VZVH4 A4	1	0,20
		40A	<b>16kW</b>	64 □	LTS40 VZVH4 A4	1	0,20
		63A	<b>22kW</b>	64 □	LTS63 VZVH4 A4	1	0,26
		80A	<b>22kW</b>	64 □	LTS80 VZVH4 A4	1	0,26
		85A	<b>30kW</b>	64 □	LTS85 VZVH4 A4	1	0,45
		100A	<b>37kW</b>	64 □	LTS100 VZVH4 A4	1	0,45
		125A	<b>45kW</b>	64 □	LTS125 VZVH4 A4	1	0,45
<b>6-pole, padlock device SV4</b> 							
		20A	<b>7,5kW</b>	64 □	LTS20 VZVH4 A6	1	0,32
		25A	<b>10kW</b>	64 □	LTS25 VZVH4 A6	1	0,32
		32A	<b>12,5kW</b>	64 □	LTS32 VZVH4 A6	1	0,32
		40A	<b>16kW</b>	64 □	LTS40 VZVH4 A6	1	0,32
		63A	<b>22kW</b>	64 □	LTS63 VZVH4 A6	1	0,37
		80A	<b>22kW</b>	64 □	LTS80 VZVH4 A6	1	0,37
<b>8-pole, padlock device SV4</b> 							
		20A	<b>7,5kW</b>	64 □	LTS20 VZVH4 A8	1	0,34
		25A	<b>10kW</b>	64 □	LTS25 VZVH4 A8	1	0,34
		32A	<b>12,5kW</b>	64 □	LTS32 VZVH4 A8	1	0,34
		40A	<b>16kW</b>	64 □	LTS40 VZVH4 A8	1	0,34
		63A	<b>22kW</b>	64 □	LTS63 VZVH4 A8	1	0,45
		80A	<b>22kW</b>	64 □	LTS80 VZVH4 A8	1	0,45

**Depth**  
 Single Hole Mounting Ø22mm  
 LTS.. VZV..

**4-Hole Mounting**  
 LTS.. V(H).. (3, 4-pole)

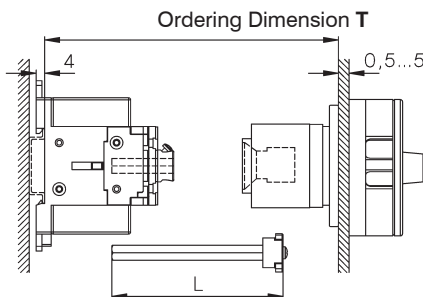
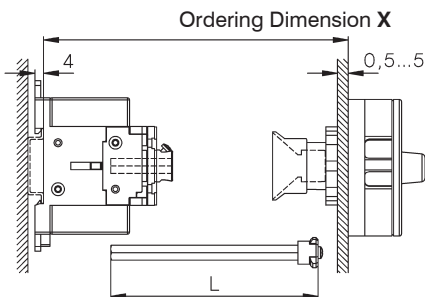



Type		X min	X max	L
LTS20-80 VZV..	3, 4-pole	91	190	<b>X - 40±3</b>
LTS20-80 VZV..	6, 8-pole	111	190	<b>X - 60±3</b>
LTS85-125 VZV..	3, 4-pole	95	190	<b>X - 44±3</b>

Type		T min	T max	L	Type	T min	T max
LTS20-80 VH..		111	190	<b>T - 60±3</b>	LT160 VH..	120	450
LTS85-125 VH..		115	190	<b>T - 64±3</b>			

greater X- and T-Dimensions (max. 380mm for LTS..) on request

Main Switches, Base Mounting with Door Clutch, Padlock Device for 4-Hole Mounting  
 Depth T is adjustable (delivered with T<sub>max</sub> see page 271), IP66, cUL<sub>us</sub> Type 4X

	max. padlocks	AC21 690V	AC23 3x400V	Plate	Type	Pack pcs.	Weight kg/pcs.	
<b>3-pole, padlock device SV4(34)</b>  								
			20A	<b>7,5kW</b>	64 □ <sup>1)</sup>	LTS20 VH4 A3	1	0,20
			25A	<b>10kW</b>	64 □ <sup>1)</sup>	LTS25 VH4 A3	1	0,20
			32A	<b>12,5kW</b>	64 □ <sup>1)</sup>	LTS32 VH4 A3	1	0,20
			40A	<b>16kW</b>	64 □ <sup>1)</sup>	LTS40 VH4 A3	1	0,20
			63A	<b>22kW</b>	64 □ <sup>1)</sup>	LTS63 VH4 A3	1	0,24
			80A	<b>22kW</b>	64 □ <sup>1)</sup>	LTS80 VH4 A3	1	0,24
			85A	<b>30kW</b>	64 □ <sup>1)</sup>	LTS85 VH4 A3	1	0,40
			100A	<b>37kW</b>	64 □ <sup>1)</sup>	LTS100 VH4 A3	1	0,40
			125A	<b>45kW</b>	64 □ <sup>1)</sup>	LTS125 VH4 A3	1	0,40
		160A	<b>55kW</b>	88 □	LT160 VH34 T300	1	1,38	

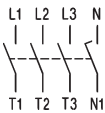
	max. padlocks	AC21 690V	AC23 3x400V	Plate	Type	Pack pcs.	Weight kg/pcs.	
<b>4-pole, padlock device SV4(34)</b>  								
			20A	<b>7,5kW</b>	64 □ <sup>1)</sup>	LTS20 VH4 A4	1	0,21
			25A	<b>10kW</b>	64 □ <sup>1)</sup>	LTS25 VH4 A4	1	0,21
			32A	<b>12,5kW</b>	64 □ <sup>1)</sup>	LTS32 VH4 A4	1	0,21
			40A	<b>16kW</b>	64 □ <sup>1)</sup>	LTS40 VH4 A4	1	0,21
			63A	<b>22kW</b>	64 □ <sup>1)</sup>	LTS63 VH4 A4	1	0,28
			80A	<b>22kW</b>	64 □ <sup>1)</sup>	LTS80 VH4 A4	1	0,28
			85A	<b>30kW</b>	64 □ <sup>1)</sup>	LTS85 VH4 A4	1	0,45
			100A	<b>37kW</b>	64 □ <sup>1)</sup>	LTS100 VH4 A4	1	0,45
			125A	<b>45kW</b>	64 □ <sup>1)</sup>	LTS125 VH4 A4	1	0,45
		160A	<b>55kW</b>	88 □	LT160 VH34 T400	1	1,77	

Emergency-Stop-Main Switches, Base Mounting with Door Clutch for Single-Hole Mounting  
 Depth X is not adjustable, declare depth X when ordering, IP66, cUL<sub>us</sub> Type 4X

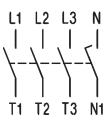
	max. padlocks	AC21 690V	AC23 3x400V	Plate	Type	Pack pcs.	Weight kg/pcs.	
<b>4-pole, padlock device SV4</b>  								
			20A	<b>7,5kW</b>	64 □	LTS20 VZH4 A4 X..	1	0,18
			25A	<b>10kW</b>	64 □	LTS25 VZH4 A4 X..	1	0,18
			32A	<b>12,5kW</b>	64 □	LTS32 VZH4 A4 X..	1	0,18
			40A	<b>16kW</b>	64 □	LTS40 VZH4 A4 X..	1	0,18
			63A	<b>22kW</b>	64 □	LTS63 VZH4 A4 X..	1	0,25
			80A	<b>22kW</b>	64 □	LTS80 VZH4 A4 X..	1	0,25

Declare depth X when ordering

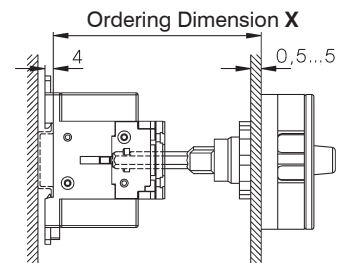

Type	Preference values for X
LT.. VZH..	80, 85, 104, 129 (tolerance -3, +1,5)







Add-on modules see page 297

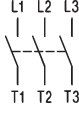

1) Types with padlock device 88 'type suffix **88**, ordering example: LTS32 VHN**488** A3, on request

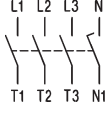
# Main Switches for Distribution Boards, lockable IP40, Open Type

		max. padlocks	AC21 690V	AC23 3x400V	Plate	Type	Pack pcs.	Weight kg/pcs.
<b>3-pole, padlock device SV1</b> 								
			20A	<b>7,5kW</b>	52x45	LTS20 SMAH1 A3 <sup>2)</sup>	1	0,15
			25A	<b>10kW</b>	52x45	LTS25 SMAH1 A3 <sup>2)</sup>	1	0,15
			32A	<b>12,5kW</b>	52x45	LTS32 SMAH1 A3 <sup>2)</sup>	1	0,15
			40A	<b>16kW</b>	52x45	LTS40 SMAH1 A3 <sup>2)</sup>	1	0,15
			63A	<b>22kW</b>	52x45	LTS63 SMAH1 A3 <sup>2)</sup>	1	0,18
			80A	<b>22kW</b>	52x45	LTS80 SMAH1 A3 <sup>2)</sup>	1	0,18
			85A	<b>30kW</b>	78x45	LTS85 SMAH1 A3	1	0,37
			100A	<b>37kW</b>	78x45	LTS100 SMAH1 A3	1	0,37
	125A	<b>45kW</b>	78x45	LTS125 SMAH1 A3	1	0,37		

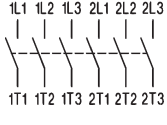

<b>4-pole, padlock device SV1</b> 								
			20A	<b>7,5kW</b>	52x45	LTS20 SMAH1 A4 <sup>2)</sup>	1	0,16
			25A	<b>10kW</b>	52x45	LTS25 SMAH1 A4 <sup>2)</sup>	1	0,16
			32A	<b>12,5kW</b>	52x45	LTS32 SMAH1 A4 <sup>2)</sup>	1	0,16
			40A	<b>16kW</b>	52x45	LTS40 SMAH1 A4 <sup>2)</sup>	1	0,16
			63A	<b>22kW</b>	52x45	LTS63 SMAH1 A4 <sup>2)</sup>	1	0,21
			80A	<b>22kW</b>	52x45	LTS80 SMAH1 A4 <sup>2)</sup>	1	0,21
			85A	<b>30kW</b>	78x45	LTS85 SMAH1 A4	1	0,42
			100A	<b>37kW</b>	78x45	LTS100 SMAH1 A4	1	0,42
	125A	<b>45kW</b>	78x45	LTS125 SMAH1 A4	1	0,42		

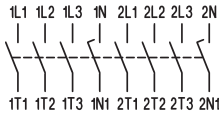
<b>6-pole, padlock device SV1 (64)</b> 								
			20A	<b>7,5kW</b>	52x45	LTS20 SMAH1 A6	1	0,29
			25A	<b>10kW</b>	52x45	LTS25 SMAH1 A6	1	0,29
			32A	<b>12,5kW</b>	52x45	LTS32 SMAH1 A6	1	0,29
			40A	<b>16kW</b>	52x45	LTS40 SMAH1 A6	1	0,29
			63A	<b>22kW</b>	97x45	LTS63 SMAH1 A6 <sup>1)</sup>	1	0,34
			80A	<b>22kW</b>	97x45	LTS80 SMAH1 A6 <sup>1)</sup>	1	0,34

<b>8-pole, padlock device SV164</b> 								
			20A	<b>7,5kW</b>	97x45	LTS20 SMAH1 A8	1	0,31
			25A	<b>10kW</b>	97x45	LTS25 SMAH1 A8	1	0,31
			32A	<b>12,5kW</b>	97x45	LTS32 SMAH1 A8	1	0,31
			40A	<b>16kW</b>	97x45	LTS40 SMAH1 A8	1	0,31
			63A	<b>22kW</b>	126x45	LTS63 SMAH1 A8	1	0,42
			80A	<b>22kW</b>	126x45	LTS80 SMAH1 A8	1	0,42

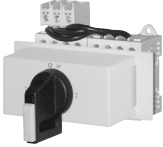
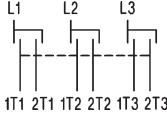
## Changeover Switch with Padlock Device for Distribution Boards, lockable

<b>3-pole, padlock device SV164</b> 								
			20A	<b>7,5kW</b>	97x45	LTS20 SMAH1 U3	1	0,29
			25A	<b>10kW</b>	97x45	LTS25 SMAH1 U3	1	0,29
			32A	<b>12,5kW</b>	97x45	LTS32 SMAH1 U3	1	0,29
			40A	<b>16kW</b>	97x45	LTS40 SMAH1 U3	1	0,29
			63A	<b>22kW</b>	97x45	LTS63 SMAH1 U3	1	0,34

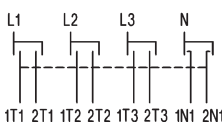









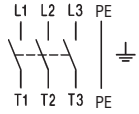

<b>4-pole, padlock device SV164</b> 								
			20A	<b>7,5kW</b>	97x45	LTS20 SMAH1 U4	1	0,31
			25A	<b>10kW</b>	97x45	LTS25 SMAH1 U4	1	0,31
			32A	<b>12,5kW</b>	97x45	LTS32 SMAH1 U4	1	0,31
			40A	<b>16kW</b>	97x45	LTS40 SMAH1 U4	1	0,31
			63A	<b>22kW</b>	126x45	LTS63 SMAH1 U4	1	0,42

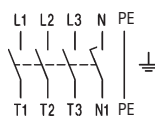
1) With padlock device SV164

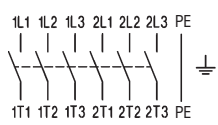
2) Emergency-Stop-Main Switches for Distribution Boards, lockable with low height handle, IP40  
Type with Type-suffix „+SV1N“ e.g.: **LTS40 SMAHN1 A3 +SV1N**

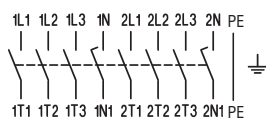

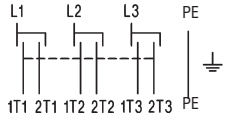

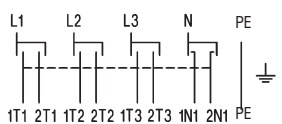





# Maintenance and Safety Switches, in Plastic Enclosure, lockable IP66, Type 4X

	max. padlocks	AC21 690V	AC23 3x400V	Plate	Type	Pack pcs.	Weight kg/pcs.
<b>3-pole, padlock device SV4(34)</b> 							
 		20A	<b>7,5kW</b>	64 □	LTS20 PF(L <sup>1</sup> )H4 A3	1	0,32
		25A	<b>10kW</b>	64 □	LTS25 PF(L <sup>1</sup> )H4 A3	1	0,32
		32A	<b>12,5kW</b>	64 □	LTS32 PF(L <sup>1</sup> )H4 A3	1	0,32
		40A	<b>16kW</b>	64 □	LTS40 PF(L <sup>1</sup> )H4 A3	1	0,32
		63A	<b>22kW</b>	64 □	LTS63 PFLH4 A3	1	0,60
		80A	<b>22kW</b>	64 □	LTS80 PFLH4 A3	1	0,60
		85A	<b>30kW</b>	64 □	LTS85 PFLH4 A3	1	0,78
		100A	<b>37kW</b>	64 □	LTS100 PFLH4 A3	1	0,78
		125A	<b>45kW</b>	64 □	LTS125 PFLH4 A3	1	0,78
		160A	<b>55kW</b>	88 □	LT160 PFH34 T300	1	2,09
Larger enclosure Type: ..PFL..	on request						
<b>4-pole, padlock device SV4(34)</b> 							
 		20A	<b>7,5kW</b>	64 □	LTS20 PF(L <sup>1</sup> )H4 A4	1	0,33
		25A	<b>10kW</b>	64 □	LTS25 PF(L <sup>1</sup> )H4 A4	1	0,33
		32A	<b>12,5kW</b>	64 □	LTS32 PF(L <sup>1</sup> )H4 A4	1	0,33
		40A	<b>16kW</b>	64 □	LTS40 PF(L <sup>1</sup> )H4 A4	1	0,33
		63A	<b>22kW</b>	64 □	LTS63 PFLH4 A4	1	0,64
		80A	<b>22kW</b>	64 □	LTS80 PFLH4 A4	1	0,64
		85A	<b>30kW</b>	64 □	LTS85 PFLH4 A4	1	0,83
		100A	<b>37kW</b>	64 □	LTS100 PFLH4 A4	1	0,83
		125A	<b>45kW</b>	64 □	LTS125 PFLH4 A4	1	0,83
		160A	<b>55kW</b>	88 □	LT160 PFH34 T400	1	2,47
Larger enclosure Type appendix +PF3 +PF3/M50	on request on request						
<b>6-pole, padlock device SV4</b> 							
 		20A	<b>7,5kW</b>	64 □	LTS20 PFLH4 A6	1	1,39
		25A	<b>10kW</b>	64 □	LTS25 PFLH4 A6	1	1,39
		32A	<b>12,5kW</b>	64 □	LTS32 PFLH4 A6	1	1,39
		40A	<b>16kW</b>	64 □	LTS40 PFLH4 A6	1	1,39
		63A	<b>22kW</b>	64 □	LTS63 PFLH4 A6	1	1,42
		80A	<b>22kW</b>	64 □	LTS80 PFLH4 A6	1	1,42
knockoutlets M50/40 +PF3/M50	on request						
<b>8-pole, padlock device SV4</b> 							
 		20A	<b>7,5kW</b>	64 □	LTS20 PFLH4 A8	1	1,44
		25A	<b>10kW</b>	64 □	LTS25 PFLH4 A8	1	1,44
		32A	<b>12,5kW</b>	64 □	LTS32 PFLH4 A8	1	1,44
		40A	<b>16kW</b>	64 □	LTS40 PFLH4 A8	1	1,44
		63A	<b>22kW</b>	64 □	LTS63 PFLH4 A8	1	1,50
		80A	<b>22kW</b>	64 □	LTS80 PFLH4 A8	1	1,50
knockoutlets M50/40 +PF3/M50	on request						
<b>Changeover Switch with Padlock Device, lockable</b>							
<b>3-pole, padlock device SV4</b> 							
 		20A	<b>7,5kW</b>	64 □	LTS20 PFLH4 U3	1	1,39
		25A	<b>10kW</b>	64 □	LTS25 PFLH4 U3	1	1,39
		32A	<b>12,5kW</b>	64 □	LTS32 PFLH4 U3	1	1,39
		40A	<b>16kW</b>	64 □	LTS40 PFLH4 U3	1	1,39
		63A	<b>22kW</b>	64 □	LTS63 PFLH4 U3	1	1,42
<b>4-pole, padlock device SV4</b> 							
 		20A	<b>7,5kW</b>	64 □	LTS20 PFLH4 U4	1	1,44
		25A	<b>10kW</b>	64 □	LTS25 PFLH4 U4	1	1,44
		32A	<b>12,5kW</b>	64 □	LTS32 PFLH4 U4	1	1,44
		40A	<b>16kW</b>	64 □	LTS40 PFLH4 U4	1	1,44
		63A	<b>22kW</b>	64 □	LTS63 PFLH4 U4	1	1,50

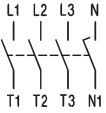
1) PFL.... larger enclosure

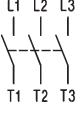
## Emergency-Stop-Main Switches for Panel Mounting, lockable IP66, Type 3R

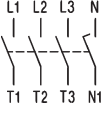
	max. padlocks	AC21 690V	AC23 3x400V	Plate	Type	Pack pcs.	Weighth kg/pcs.
<b>3-pole, padlock device SV1</b> 							
		20A	<b>7,5kW</b>	48 □ <sup>1)</sup>	LTS20 EHN1 A3	1	0,15
		25A	<b>10kW</b>	48 □ <sup>1)</sup>	LTS25 EHN1 A3	1	0,15
		32A	<b>12,5kW</b>	48 □ <sup>1)</sup>	LTS32 EHN1 A3	1	0,15
		40A	<b>16kW</b>	48 □ <sup>1)</sup>	LTS40 EHN1 A3	1	0,15
		63A	<b>22kW</b>	48 □ <sup>1)</sup>	LTS63 EHN1 A3	1	0,17
		80A	<b>22kW</b>	48 □ <sup>1)</sup>	LTS80 EHN1 A3	1	0,17
							
<b>4-pole, padlock device SV1</b> 							
		20A	<b>7,5kW</b>	48 □ <sup>1)</sup>	LTS20 EHN1 A4	1	0,19
		25A	<b>10kW</b>	48 □ <sup>1)</sup>	LTS25 EHN1 A4	1	0,19
		32A	<b>12,5kW</b>	48 □ <sup>1)</sup>	LTS32 EHN1 A4	1	0,19
		40A	<b>16kW</b>	48 □ <sup>1)</sup>	LTS40 EHN1 A4	1	0,19
		63A	<b>22kW</b>	48 □ <sup>1)</sup>	LTS63 EHN1 A4	1	0,21
		80A	<b>22kW</b>	48 □ <sup>1)</sup>	LTS80 EHN1 A4	1	0,21
							
<b>3-pole, padlock device SV4(34)</b> 							
		20A	<b>7,5kW</b>	64 □ <sup>2)</sup>	LTS20 EHN4 A3	1	0,17
		25A	<b>10kW</b>	64 □ <sup>2)</sup>	LTS25 EHN4 A3	1	0,17
		32A	<b>12,5kW</b>	64 □ <sup>2)</sup>	LTS32 EHN4 A3	1	0,17
		40A	<b>16kW</b>	64 □ <sup>2)</sup>	LTS40 EHN4 A3	1	0,17
		63A	<b>22kW</b>	64 □ <sup>2)</sup>	LTS63 EHN4 A3	1	0,19
		80A	<b>22kW</b>	64 □ <sup>2)</sup>	LTS80 EHN4 A3	1	0,19
		85A	<b>30kW</b>	64 □ <sup>2)</sup>	LTS85 EHN4 A3	1	0,39
		100A	<b>37kW</b>	64 □ <sup>2)</sup>	LTS100 EHN4 A3	1	0,39
		125A	<b>45kW</b>	64 □ <sup>2)</sup>	LTS125 EHN4 A3	1	0,39
		160A	<b>55kW</b>	88 □	LT160 EHN34 T300	1	1,16
							
<b>4-pole, padlock device SV4(34)</b> 							
		20A	<b>7,5kW</b>	64 □ <sup>2)</sup>	LTS20 EHN4 A4	1	0,20
		25A	<b>10kW</b>	64 □ <sup>2)</sup>	LTS25 EHN4 A4	1	0,20
		32A	<b>12,5kW</b>	64 □ <sup>2)</sup>	LTS32 EHN4 A4	1	0,20
		40A	<b>16kW</b>	64 □ <sup>2)</sup>	LTS40 EHN4 A4	1	0,20
		63A	<b>22kW</b>	64 □ <sup>2)</sup>	LTS63 EHN4 A4	1	0,23
		80A	<b>22kW</b>	64 □ <sup>2)</sup>	LTS80 EHN4 A4	1	0,23
		85A	<b>30kW</b>	64 □ <sup>2)</sup>	LTS85 EHN4 A4	1	0,44
		100A	<b>37kW</b>	64 □ <sup>2)</sup>	LTS100 EHN4 A4	1	0,44
		125A	<b>45kW</b>	64 □ <sup>2)</sup>	LTS125 EHN4 A4	1	0,44
		160A	<b>55kW</b>	88 □	LT160 EHN34 T400	1	1,55
							

**Add-on modules** see page 297

**Extended Switch Shaft for switches for panel mounting**





type suffix +VW"x"

x = panel thickness



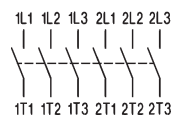
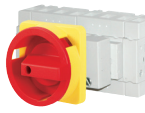

1) Types with padlock device 64 type suffix **64**, ordering example: LTS32 EHN1**64** A3, on request

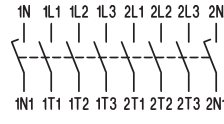
2) Types with padlock device 88 type suffix **88**, ordering example: LTS32 EHN**88** A3, on request



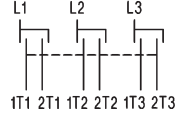
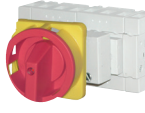

## Emergency-Stop-Main Switches for Panel Mounting, lockable IP66, Type 3R

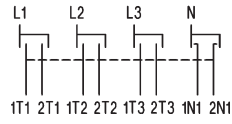
	max. padlocks	AC21 690V	AC23 3x400V	Plate	Type	Pack pcs.	Weight kg/pcs.
<b>6-pole, padlock device SV4</b> 							
		20A	<b>7,5kW</b>	64 □	LTS20 EHN4 A6	1	0,30
		25A	<b>10kW</b>	64 □	LTS25 EHN4 A6	1	0,30
		32A	<b>12,5kW</b>	64 □	LTS32 EHN4 A6	1	0,30
		40A	<b>16kW</b>	64 □	LTS40 EHN4 A6	1	0,30
		63A	<b>22kW</b>	64 □	LTS63 EHN4 A6	1	0,34
		80A	<b>22kW</b>	64 □	LTS80 EHN4 A6	1	0,34
							
<b>8-pole, padlock device SV4</b> 							
		20A	<b>7,5kW</b>	64 □	LTS20 EHN4 A8	1	0,38
		25A	<b>10kW</b>	64 □	LTS25 EHN4 A8	1	0,38
		32A	<b>12,5kW</b>	64 □	LTS32 EHN4 A8	1	0,38
		40A	<b>16kW</b>	64 □	LTS40 EHN4 A8	1	0,38
		63A	<b>22kW</b>	64 □	LTS63 EHN4 A8	1	0,42
		80A	<b>22kW</b>	64 □	LTS80 EHN4 A8	1	0,42
							

## Changeover Switch with Padlock Device for Panel Mounting, lockable IP66

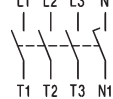

<b>3-pole, padlock device SV4</b> 							
		20A	<b>7,5kW</b>	64 □	LTS20 EHN4 U3	1	0,30
		25A	<b>10kW</b>	64 □	LTS25 EHN4 U3	1	0,30
		32A	<b>12,5kW</b>	64 □	LTS32 EHN4 U3	1	0,30
		40A	<b>16kW</b>	64 □	LTS40 EHN4 U3	1	0,30
		63A	<b>22kW</b>	64 □	LTS63 EHN4 U3	1	0,34
							
<b>4-pole, padlock device SV4</b> 							
		20A	<b>7,5kW</b>	64 □	LTS20 EHN4 U4	1	0,38
		25A	<b>10kW</b>	64 □	LTS25 EHN4 U4	1	0,38
		32A	<b>12,5kW</b>	64 □	LTS32 EHN4 U4	1	0,38
		40A	<b>16kW</b>	64 □	LTS40 EHN4 U4	1	0,38
		63A	<b>22kW</b>	64 □	LTS63 EHN4 U4	1	0,42
							

## Main Switches Emergency-Stop for Single Hole Mounting, lockable IP66 Type 4X

	max. padlocks	AC21 690V	AC23 3x400V	Plate	Type	Pack pcs.	Weight kg/pcs.
<b>3-pole, padlock device SV1</b> 							
		20A	<b>7,5kW</b>	48 □	LTS20 ZHN1 A3	1	0,16
		25A	<b>10kW</b>	48 □	LTS25 ZHN1 A3	1	0,16
		32A	<b>12,5kW</b>	48 □	LTS32 ZHN1 A3	1	0,16
		40A	<b>16kW</b>	48 □	LTS40 ZHN1 A3	1	0,16
							
<b>4-pole, padlock device SV1</b> 							
		20A	<b>7,5kW</b>	48 □	LTS20 ZHN1 A4	1	0,20
		25A	<b>10kW</b>	48 □	LTS25 ZHN1 A4	1	0,20
		32A	<b>12,5kW</b>	48 □	LTS32 ZHN1 A4	1	0,20
		40A	<b>16kW</b>	48 □	LTS40 ZHN1 A4	1	0,20
							

Add-on modules see page 295

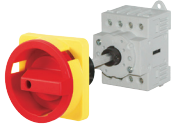
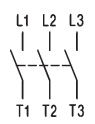
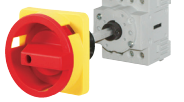
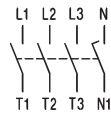
Emergency-Stop-Main Switches, Base Mounting with Door Clutch for Single-Hole Mounting  
 Depth X is adjustable (delivered with X<sub>max</sub> see below), IP66, cUL<sub>us</sub> Type 4X

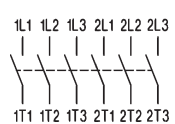
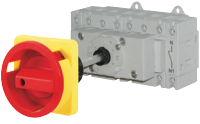
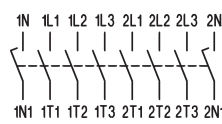
	max. padlocks	AC21 690V	AC23 3x400V	Plate	Type	Pack pcs.	Weight kg/pcs.
<b>3-pole, padlock device SV4</b>							
 	3	20A	<b>7,5kW</b>	64 □	LTS20 VZVHN4 A3	1	0,19
		25A	<b>10kW</b>	64 □	LTS25 VZVHN4 A3	1	0,19
		32A	<b>12,5kW</b>	64 □	LTS32 VZVHN4 A3	1	0,19
		40A	<b>16kW</b>	64 □	LTS40 VZVHN4 A3	1	0,19
		63A	<b>22kW</b>	64 □	LTS63 VZVHN4 A3	1	0,22
		80A	<b>22kW</b>	64 □	LTS80 VZVHN4 A3	1	0,22
		85A	<b>30kW</b>	64 □	LTS85 VZVHN4 A3	1	0,40
	100A	<b>37kW</b>	64 □	LTS100 VZVHN4 A3	1	0,40	
	125A	<b>45kW</b>	64 □	LTS125 VZVHN4 A3	1	0,40	
<b>4-pole, padlock device SV4</b>							
 	3	20A	<b>7,5kW</b>	64 □	LTS20 VZVHN4 A4	1	0,20
		25A	<b>10kW</b>	64 □	LTS25 VZVHN4 A4	1	0,20
		32A	<b>12,5kW</b>	64 □	LTS32 VZVHN4 A4	1	0,20
		40A	<b>16kW</b>	64 □	LTS40 VZVHN4 A4	1	0,20
		63A	<b>22kW</b>	64 □	LTS63 VZVHN4 A4	1	0,26
		80A	<b>22kW</b>	64 □	LTS80 VZVHN4 A4	1	0,26
		85A	<b>30kW</b>	64 □	LTS85 VZVHN4 A4	1	0,45
	100A	<b>37kW</b>	64 □	LTS100 VZVHN4 A4	1	0,45	
	125A	<b>45kW</b>	64 □	LTS125 VZVHN4 A4	1	0,45	
<b>6-pole, padlock device SV4</b>							
 	3	20A	<b>7,5kW</b>	64 □	LTS20 VZVHN4 A6	1	0,32
		25A	<b>10kW</b>	64 □	LTS25 VZVHN4 A6	1	0,32
		32A	<b>12,5kW</b>	64 □	LTS32 VZVHN4 A6	1	0,32
		40A	<b>16kW</b>	64 □	LTS40 VZVHN4 A6	1	0,32
		63A	<b>22kW</b>	64 □	LTS63 VZVHN4 A6	1	0,37
		80A	<b>22kW</b>	64 □	LTS80 VZVHN4 A6	1	0,37
<b>8-pole, padlock device SV4</b>							
 	3	20A	<b>7,5kW</b>	64 □	LTS20 VZVHN4 A8	1	0,34
		25A	<b>10kW</b>	64 □	LTS25 VZVHN4 A8	1	0,34
		32A	<b>12,5kW</b>	64 □	LTS32 VZVHN4 A8	1	0,34
		40A	<b>16kW</b>	64 □	LTS40 VZVHN4 A8	1	0,34
		63A	<b>22kW</b>	64 □	LTS63 VZVHN4 A8	1	0,45
	80A	<b>22kW</b>	64 □	LTS80 VZVHN4 A8	1	0,45	

**Depth**  
 Single Hole Mounting Ø22mm  
 LTS.. VZV..

**4-Hole Mounting**  
 LTS.. V(HN).. (3, 4-pole)

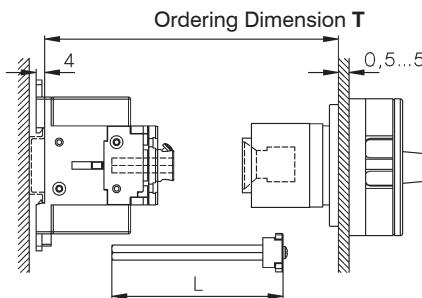
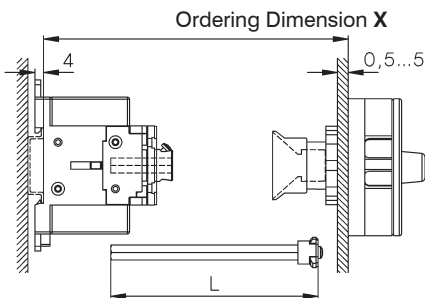



Type		X min	X max	L
LTS20-80 VZV..	3, 4-polig	91 -	190	<b>X - 40±3</b>
LTS20-80 VZV..	6, 8-polig	111 -	190	<b>X - 60±3</b>
LTS85-125 VZV..	3, 4-polig	95-	190	<b>X - 44±3</b>

Type	T min	T max	L	Type	T min	T max
LTS20-80 VH..	111 -	190	<b>T - 60±3</b>	LT160 VH..	120 -	450
LTS85-125 VH..	115 -	190	<b>T - 64±3</b>			

Greater X- and T-Dimensions (max. 380mm for LTS..) on request

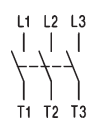
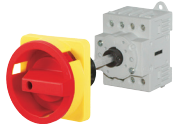
Emergency-Stop-Main Switches, Base Mounting with Door Clutch, Padlock Device for 4-Hole Mounting, Depth T is adjustable (delivered with T<sub>max</sub> see page 282), IP66,  Type 4X

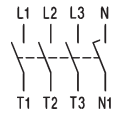
	max. padlocks	AC21 690V	AC23 3x400V	Schild	Type	Pack pcs.	Weight kg/pcs.	
<b>3-pole, padlock device SV4(34)</b>  								
			20A	<b>7,5kW</b>	64 □ <sup>1)</sup>	LTS20 VHN4 A3	1	0,20
			25A	<b>10kW</b>	64 □ <sup>1)</sup>	LTS25 VHN4 A3	1	0,20
			32A	<b>12,5kW</b>	64 □ <sup>1)</sup>	LTS32 VHN4 A3	1	0,20
			40A	<b>16kW</b>	64 □ <sup>1)</sup>	LTS40 VHN4 A3	1	0,20
			63A	<b>22kW</b>	64 □ <sup>1)</sup>	LTS63 VHN4 A3	1	0,24
			80A	<b>22kW</b>	64 □ <sup>1)</sup>	LTS80 VHN4 A3	1	0,24
			85A	<b>30kW</b>	64 □ <sup>1)</sup>	LTS85 VHN4 A3	1	0,40
			100A	<b>37kW</b>	64 □ <sup>1)</sup>	LTS100 VHN4 A3	1	0,40
			125A	<b>45kW</b>	64 □ <sup>1)</sup>	LTS125 VHN4 A3	1	0,40
		160A	<b>55kW</b>	88 □	LT160 VHN34 T300	1	1,38	

<b>4-pole, padlock device SV4(34)</b>  			20A	<b>7,5kW</b>	64 □ <sup>1)</sup>	LTS20 VHN4 A4	1	0,21
			25A	<b>10kW</b>	64 □ <sup>1)</sup>	LTS25 VHN4 A4	1	0,21
			32A	<b>12,5kW</b>	64 □ <sup>1)</sup>	LTS32 VHN4 A4	1	0,21
			40A	<b>16kW</b>	64 □ <sup>1)</sup>	LTS40 VHN4 A4	1	0,21
			63A	<b>22kW</b>	64 □ <sup>1)</sup>	LTS63 VHN4 A4	1	0,28
			80A	<b>22kW</b>	64 □ <sup>1)</sup>	LTS80 VHN4 A4	1	0,28
			85A	<b>30kW</b>	64 □ <sup>1)</sup>	LTS85 VHN4 A4	1	0,45
			100A	<b>37kW</b>	64 □ <sup>1)</sup>	LTS100 VHN4 A4	1	0,45
			125A	<b>45kW</b>	64 □ <sup>1)</sup>	LTS125 VHN4 A4	1	0,45
			160A	<b>55kW</b>	88 □	LT160 VHN34 T400	1	1,77

Emergency-Stop-Main Switches, Base Mounting with Door Clutch for Single-Hole Mounting Depth X is not adjustable, declare depth X when ordering, IP66,  Type 4x

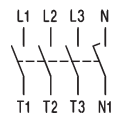
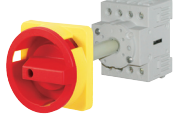
<b>4-pole, padlock device SV4</b>  			20A	<b>7,5kW</b>	64 □	LTS20 VZHN4 A4 X..	1	0,18
			25A	<b>10kW</b>	64 □	LTS25 VZHN4 A4 X..	1	0,18
			32A	<b>12,5kW</b>	64 □	LTS32 VZHN4 A4 X..	1	0,18
			40A	<b>16kW</b>	64 □	LTS40 VZHN4 A4 X..	1	0,18
			63A	<b>22kW</b>	64 □	LTS63 VZHN4 A4 X..	1	0,25
			80A	<b>22kW</b>	64 □	LTS80 VZHN4 A4 X..	1	0,25

Declare depth X when ordering

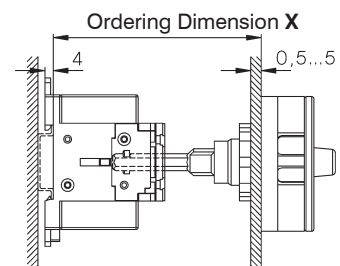

Type	Preference values for X
LTS.. VZH..	80, 85, 104, 129 (tolerance -3, +1,5)





Add-on modules see page 297

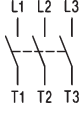

1) Types with padlock device 88 'type suffix **88**, ordering example: LTS32 VHN**488** A3, on request

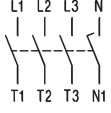
## Emergency-Stop-Main Switches for Distribution Boards, lockable IP40, Open Type

		max. padlocks	AC21 690V	AC23 3x400V	Plate	Type	Pack pcs.	Weight kg/pcs.
<b>3-pole, padlock device SV1</b> 								
			20A	<b>7,5kW</b>	52x45	LTS20 SMAHN1 A3 <sup>2)</sup>	1	0,15
			25A	<b>10kW</b>	52x45	LTS25 SMAHN1 A3 <sup>2)</sup>	1	0,15
			32A	<b>12,5kW</b>	52x45	LTS32 SMAHN1 A3 <sup>2)</sup>	1	0,15
			40A	<b>16kW</b>	52x45	LTS40 SMAHN1 A3 <sup>2)</sup>	1	0,15
			63A	<b>22kW</b>	52x45	LTS63 SMAHN1 A3 <sup>2)</sup>	1	0,18
			80A	<b>22kW</b>	52x45	LTS80 SMAHN1 A3 <sup>2)</sup>	1	0,18
			85A	<b>30kW</b>	78x45	LTS85 SMAHN1 A3	1	0,37
			100A	<b>37kW</b>	78x45	LTS100 SMAHN1 A3	1	0,37
	125A	<b>45kW</b>	78x45	LTS125 SMAHN1 A3	1	0,37		

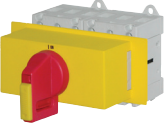
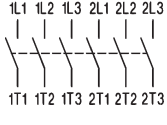
<b>4-pole, padlock device SV1</b> 								
			20A	<b>7,5kW</b>	52x45	LTS20 SMAHN1 A4 <sup>2)</sup>	1	0,16
			25A	<b>10kW</b>	52x45	LTS25 SMAHN1 A4 <sup>2)</sup>	1	0,16
			32A	<b>12,5kW</b>	52x45	LTS32 SMAHN1 A4 <sup>2)</sup>	1	0,16
			40A	<b>16kW</b>	52x45	LTS40 SMAHN1 A4 <sup>2)</sup>	1	0,16
			63A	<b>22kW</b>	52x45	LTS63 SMAHN1 A4 <sup>2)</sup>	1	0,21
			80A	<b>22kW</b>	52x45	LTS80 SMAHN1 A4 <sup>2)</sup>	1	0,21
			85A	<b>30kW</b>	78x45	LTS85 SMAHN1 A4	1	0,42
			100A	<b>37kW</b>	78x45	LTS100 SMAHN1 A4	1	0,42
	125A	<b>45kW</b>	78x45	LTS125 SMAHN1 A4	1	0,42		

<b>6-pole, padlock device SV1 (64)</b> 								
			20A	<b>7,5kW</b>	52x45	LTS20 SMAHN1 A6	1	0,29
			25A	<b>10kW</b>	52x45	LTS25 SMAHN1 A6	1	0,29
			32A	<b>12,5kW</b>	52x45	LTS32 SMAHN1 A6	1	0,29
			40A	<b>16kW</b>	52x45	LTS40 SMAHN1 A6	1	0,29
			63A	<b>22kW</b>	97x45	LTS63 SMAHN1 A6 <sup>1)</sup>	1	0,34
			80A	<b>22kW</b>	97x45	LTS80 SMAHN1 A6 <sup>1)</sup>	1	0,34

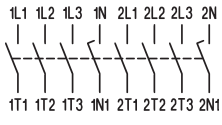
<b>8-pole, padlock device SV164</b> 								
			20A	<b>7,5kW</b>	97x45	LTS20 SMAHN1 A8	1	0,31
			25A	<b>10kW</b>	97x45	LTS25 SMAHN1 A8	1	0,31
			32A	<b>12,5kW</b>	97x45	LTS32 SMAHN1 A8	1	0,31
			40A	<b>16kW</b>	97x45	LTS40 SMAHN1 A8	1	0,31
			63A	<b>22kW</b>	126x45	LTS63 SMAHN1 A8	1	0,42
			80A	<b>22kW</b>	126x45	LTS80 SMAHN1 A8	1	0,42

### Changeover Switch with Padlock Device for Distribution Boards, lockable

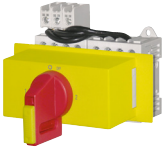
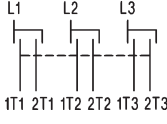

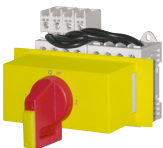
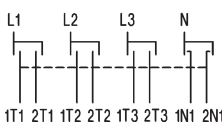







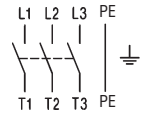

<b>3-pole, padlock device SV164</b> 								
			20A	<b>7,5kW</b>	97x45	LTS20 SMAHN1 U3	1	0,29
			25A	<b>10kW</b>	97x45	LTS25 SMAHN1 U3	1	0,29
			32A	<b>12,5kW</b>	97x45	LTS32 SMAHN1 U3	1	0,29
			40A	<b>16kW</b>	97x45	LTS40 SMAHN1 U3	1	0,29
			63A	<b>22kW</b>	97x45	LTS63 SMAHN1 U3	1	0,34

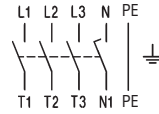
<b>4-pole, padlock device SV164</b> 								
			20A	<b>7,5kW</b>	97x45	LTS20 SMAHN1 U4	1	0,31
			25A	<b>10kW</b>	97x45	LTS25 SMAHN1 U4	1	0,31
			32A	<b>12,5kW</b>	97x45	LTS32 SMAHN1 U4	1	0,31
			40A	<b>16kW</b>	97x45	LTS40 SMAHN1 U4	1	0,31
			63A	<b>22kW</b>	126x45	LTS63 SMAHN1 U4	1	0,42

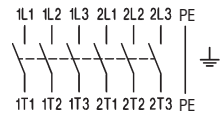
1) With padlock device SV164

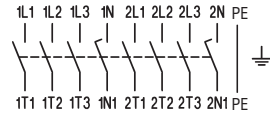

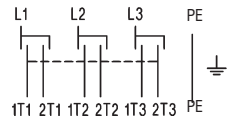

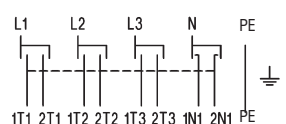

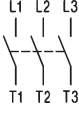

2) Emergency-Stop-Main Switches for Distribution Boards, lockable with low height handle, IP40  
Type with Type-suffix „+SV1N“ e.g.: **LTS40 SMAHN1 A3 +SV1N**

Maintenance and Safety Emergency-Stop-Main Switches, in Plastic Enclosure, lockable IP66,  us Type 4X

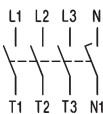
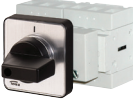
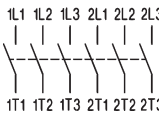
	max. padlocks	AC21 690V	AC23 3x400V	Plate	Type	Pack pcs.	Weight kg/pcs.	
<b>3-pole, padlock device SV4(34)</b> 								
 		20A	<b>7,5kW</b>	64 □	LTS20 PF(L <sup>1)</sup> )HN4 A3	1	0,32	
		25A	<b>10kW</b>	64 □	LTS25 PF(L <sup>1)</sup> )HN4 A3	1	0,32	
		32A	<b>12,5kW</b>	64 □	LTS32 PF(L <sup>1)</sup> )HN4 A3	1	0,32	
		40A	<b>16kW</b>	64 □	LTS40 PF(L <sup>1)</sup> )HN4 A3	1	0,32	
		63A	<b>22kW</b>	64 □	LTS63 PFLHN4 A3	1	0,60	
		80A	<b>22kW</b>	64 □	LTS80 PFLHN4 A3	1	0,60	
		85A	<b>30kW</b>	64 □	LTS85 PFLHN4 A3	1	0,78	
		100A	<b>37kW</b>	64 □	LTS100 PFLHN4 A3	1	0,78	
		125A	<b>45kW</b>	64 □	LTS125 PFLHN4 A3	1	0,78	
		160A	<b>55kW</b>	88 □	LT160 PFHN34 T300	1	2,09	
Larger enclosure Type: ..PFL..	on request							
<b>4-pole, padlock device SV4(34)</b> 								
 		20A	<b>7,5kW</b>	64 □	LTS20 PF(L <sup>1)</sup> )HN4 A4	1	0,33	
		25A	<b>10kW</b>	64 □	LTS25 PF(L <sup>1)</sup> )HN4 A4	1	0,33	
		32A	<b>12,5kW</b>	64 □	LTS32 PF(L <sup>1)</sup> )HN4 A4	1	0,33	
		40A	<b>16kW</b>	64 □	LTS40 PF(L <sup>1)</sup> )HN4 A4	1	0,33	
		63A	<b>22kW</b>	64 □	LTS63 PFLHN4 A4	1	0,64	
		80A	<b>22kW</b>	64 □	LTS80 PFLHN4 A4	1	0,64	
		85A	<b>30kW</b>	64 □	LTS85 PFLHN4 A4	1	0,83	
		100A	<b>37kW</b>	64 □	LTS100 PFLHN4 A4	1	0,83	
		125A	<b>45kW</b>	64 □	LTS125 PFLHN4 A4	1	0,83	
		160A	<b>55kW</b>	88 □	LT160 PFHN34 T400	1	2,47	
Larger enclosure Type appendix +PF3 +PF3/M50	on request on request							
<b>6-pole, padlock device SV4</b> 								
 		20A	<b>7,5kW</b>	64 □	LTS20 PFLHN4 A6	1	1,39	
		25A	<b>10kW</b>	64 □	LTS25 PFLHN4 A6	1	1,39	
		32A	<b>12,5kW</b>	64 □	LTS32 PFLHN4 A6	1	1,39	
		40A	<b>16kW</b>	64 □	LTS40 PFLHN4 A6	1	1,39	
		63A	<b>22kW</b>	64 □	LTS63 PFLHN4 A6	1	1,42	
		80A	<b>22kW</b>	64 □	LTS80 PFLHN4 A6	1	1,42	
	knockoutlets M50/40 +PF3/M50	on request						
	<b>8-pole, padlock device SV4</b> 							
	 		20A	<b>7,5kW</b>	64 □	LTS20 PFLHN4 A8	1	1,44
			25A	<b>10kW</b>	64 □	LTS25 PFLHN4 A8	1	1,44
		32A	<b>12,5kW</b>	64 □	LTS32 PFLHN4 A8	1	1,44	
		40A	<b>16kW</b>	64 □	LTS40 PFLHN4 A8	1	1,44	
		63A	<b>22kW</b>	64 □	LTS63 PFLHN4 A8	1	1,50	
		80A	<b>22kW</b>	64 □	LTS80 PFLHN4 A8	1	1,50	
knockoutlets M50/40 +PF3/M50		on request						
<b>Changeover Switch with Padlock Device, lockable</b>								
<b>3-pole, padlock device SV4</b> 								
 			20A	<b>7,5kW</b>	64 □	LTS20 PFLHN4 U3	1	1,39
		25A	<b>10kW</b>	64 □	LTS25 PFLHN4 U3	1	1,39	
		32A	<b>12,5kW</b>	64 □	LTS32 PFLHN4 U3	1	1,39	
		40A	<b>16kW</b>	64 □	LTS40 PFLHN4 U3	1	1,39	
		63A	<b>22kW</b>	64 □	LTS63 PFLHN4 U3	1	1,42	
<b>4-pole, padlock device SV4</b> 								
 		20A	<b>7,5kW</b>	64 □	LTS20 PFLHN4 U4	1	1,44	
		25A	<b>10kW</b>	64 □	LTS25 PFLHN4 U4	1	1,44	
		32A	<b>12,5kW</b>	64 □	LTS32 PFLHN4 U4	1	1,44	
		40A	<b>16kW</b>	64 □	LTS40 PFLHN4 U4	1	1,44	
		63A	<b>22kW</b>	64 □	LTS63 PFLHN4 U4	1	1,50	

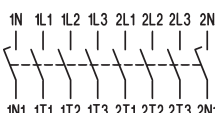

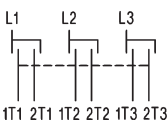
1) PFL.... larger enclosure

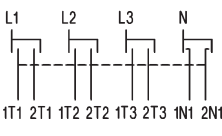
Switch Disconnectors for Panel Mounting, IP66,  Type 3R



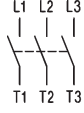

		AC21 690V	AC23 3x400V	Plate	Type	Pack pcs.	Weight kg/pcs.
<b>On-Off Switches 3-pole</b>							
		20A	<b>7,5kW</b>	48 □	LTS20 E A3	1	0,15
		25A	<b>10kW</b>	48 □	LTS25 E A3	1	0,15
		32A	<b>12,5kW</b>	48 □	LTS32 E A3	1	0,15
		40A	<b>16kW</b>	48 □	LTS40 E A3	1	0,15
		63A	<b>22kW</b>	48 □	LTS63 E A3	1	0,17
		80A	<b>22kW</b>	48 □	LTS80 E A3	1	0,17
		85A	<b>30kW</b>	64 □	LTS85 E A3	1	0,39
		100A	<b>37kW</b>	64 □	LTS100 E A3	1	0,39
		125A	<b>45kW</b>	64 □	LTS125 E A3	1	0,39
		160A	<b>55kW</b>	88 □	LT160 E T300	1	1,10
<b>On-Off Switches 4-pole</b>							
		20A	<b>7,5kW</b>	48 □	LTS20 E A4	1	0,18
		25A	<b>10kW</b>	48 □	LTS25 E A4	1	0,18
		32A	<b>12,5kW</b>	48 □	LTS32 E A4	1	0,18
		40A	<b>16kW</b>	48 □	LTS40 E A4	1	0,18
		63A	<b>22kW</b>	48 □	LTS63 E A4	1	0,21
		80A	<b>22kW</b>	48 □	LTS80 E A4	1	0,21
		85A	<b>30kW</b>	64 □	LTS85 E A4	1	0,44
		100A	<b>37kW</b>	64 □	LTS100 E A4	1	0,44
		125A	<b>45kW</b>	64 □	LTS125 E A4	1	0,44
		160A	<b>55kW</b>	88 □	LT160 E T400	1	1,50
<b>On-Off Switches 6-pole</b>							
		20A	<b>7,5kW</b>	64 □	LTS20 E A6	1	0,30
		25A	<b>10kW</b>	64 □	LTS25 E A6	1	0,30
		32A	<b>12,5kW</b>	64 □	LTS32 E A6	1	0,30
		40A	<b>16kW</b>	64 □	LTS40 E A6	1	0,30
		63A	<b>22kW</b>	64 □	LTS63 E A6	1	0,36
		80A	<b>22kW</b>	64 □	LTS80 E A6	1	0,36
<b>On-Off Switches 8-pole</b>							
		20A	<b>7,5kW</b>	64 □	LTS20 E A8	1	0,32
		25A	<b>10kW</b>	64 □	LTS25 E A8	1	0,32
		32A	<b>12,5kW</b>	64 □	LTS32 E A8	1	0,32
		40A	<b>16kW</b>	64 □	LTS40 E A8	1	0,32
		63A	<b>22kW</b>	64 □	LTS63 E A8	1	0,43
		80A	<b>22kW</b>	64 □	LTS80 E A8	1	0,43
<b>Changeover Switches 3-pole</b>							
		20A	<b>7,5kW</b>	64 □	LTS20 E U3	1	0,31
		25A	<b>10kW</b>	64 □	LTS25 E U3	1	0,31
		32A	<b>12,5kW</b>	64 □	LTS32 E U3	1	0,31
		40A	<b>16kW</b>	64 □	LTS40 E U3	1	0,31
		63A	<b>22kW</b>	64 □	LTS63 E U3	1	0,37
<b>Changeover Switches 4-pole</b>							
		20A	<b>7,5kW</b>	64 □	LTS20 E U4	1	0,33
		25A	<b>10kW</b>	64 □	LTS25 E U4	1	0,33
		32A	<b>12,5kW</b>	64 □	LTS32 E U4	1	0,33
		40A	<b>16kW</b>	64 □	LTS40 E U4	1	0,33
		63A	<b>22kW</b>	64 □	LTS63 E U4	1	0,44

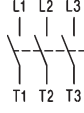

Switch Disconnectors for Single Hole Mounting, lockable IP66, c(UL)us Type 4X

	AC21 690V	AC23 3x400V	Plate	Type	Pack pcs.	Weight kg/pcs.
<b>On-Off Switches 3-pole</b>						
 	20A	<b>7,5kW</b>	48 □	LTS20 Z A3	1	0,16
	25A	<b>10kW</b>	48 □	LTS25 Z A3	1	0,16
	32A	<b>12,5kW</b>	48 □	LTS32 Z A3	1	0,16
	40A	<b>16kW</b>	48 □	LTS40 Z A3	1	0,16
<b>On-Off Switches 4-pole</b>						
 	20A	<b>7,5kW</b>	48 □	LTS20 Z A4	1	0,20
	25A	<b>10kW</b>	48 □	LTS25 Z A4	1	0,20
	32A	<b>12,5kW</b>	48 □	LTS32 Z A4	1	0,20
	40A	<b>16kW</b>	48 □	LTS40 Z A4	1	0,20

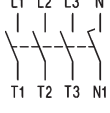
Switch Disconnectors, Base Mounting with Door Clutch for Single-Hole Mounting  
Depth X is adjustable (delivered with X<sub>max</sub> see page 294), IP66, c(UL)us Type 4X

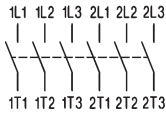
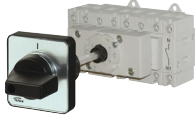
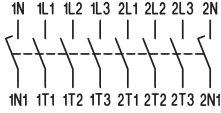
	AC21 690V	AC23 3x400V	Plate	Type	Pack pcs.	Weight kg/pcs.
<b>On-Off Switches 3-pole</b>						
 	20A	<b>7,5kW</b>	64 □	LTS20 VZV A3	1	0,19
	25A	<b>10kW</b>	64 □	LTS25 VZV A3	1	0,19
	32A	<b>12,5kW</b>	64 □	LTS32 VZV A3	1	0,19
	40A	<b>16kW</b>	64 □	LTS40 VZV A3	1	0,19
	63A	<b>22kW</b>	64 □	LTS63 VZV A3	1	0,22
	80A	<b>22kW</b>	64 □	LTS80 VZV A3	1	0,22
	85A	<b>30kW</b>	64 □	LTS85 VZV A3	1	0,40
	100A	<b>37kW</b>	64 □	LTS100 VZV A3	1	0,40
125A	<b>45kW</b>	64 □	LTS125 VZV A3	1	0,40	
<b>On-Off Switches 4-pole</b>						
 	20A	<b>7,5kW</b>	64 □	LTS20 VZV A4	1	0,20
	25A	<b>10kW</b>	64 □	LTS25 VZV A4	1	0,20
	32A	<b>12,5kW</b>	64 □	LTS32 VZV A4	1	0,20
	40A	<b>16kW</b>	64 □	LTS40 VZV A4	1	0,20
	63A	<b>22kW</b>	64 □	LTS63 VZV A4	1	0,26
	80A	<b>22kW</b>	64 □	LTS80 VZV A4	1	0,26
	85A	<b>30kW</b>	64 □	LTS85 VZV A4	1	0,45
	100A	<b>37kW</b>	64 □	LTS100 VZV A4	1	0,45
125A	<b>45kW</b>	64 □	LTS125 VZV A4	1	0,45	
<b>On-Off Switches 6-pole</b>						
 	20A	<b>7,5kW</b>	64 □	LTS20 VZV A6	1	0,32
	25A	<b>10kW</b>	64 □	LTS25 VZV A6	1	0,32
	32A	<b>12,5kW</b>	64 □	LTS32 VZV A6	1	0,32
	40A	<b>16kW</b>	64 □	LTS40 VZV A6	1	0,32
	63A	<b>22kW</b>	64 □	LTS63 VZV A6	1	0,37
	80A	<b>22kW</b>	64 □	LTS80 VZV A6	1	0,37
<b>On-Off Switches 8-pole</b>						
 	20A	<b>7,5kW</b>	64 □	LTS20 VZV A8	1	0,34
	25A	<b>10kW</b>	64 □	LTS25 VZV A8	1	0,34
	32A	<b>12,5kW</b>	64 □	LTS32 VZV A8	1	0,34
	40A	<b>16kW</b>	64 □	LTS40 VZV A8	1	0,34
	63A	<b>22kW</b>	64 □	LTS63 VZV A8	1	0,45
	80A	<b>22kW</b>	64 □	LTS80 VZV A8	1	0,45

## Switch Disconnecter, Base Mounting with Door Clutch for Single-Hole Mounting Depth X is adjustable (delivered with X<sub>max</sub> see below), IP66, cUL<sub>us</sub> Type 4X

**Depth**  
**Single Hole Mounting Ø22mm**  
**LTS.. VZV..**

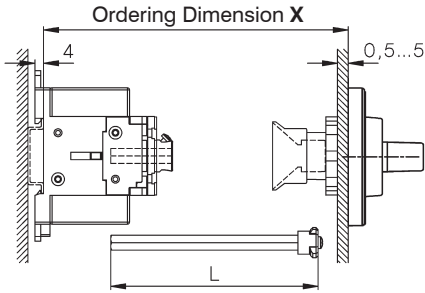

Type		X min	X max	L
LTS20-80 VZV..	3, 4-polig	91 -	190	X - 40±3
LTS20-80 VZV..	6, 8-polig	111 -	190	X - 60±3
LTS85-125 VZV..	3, 4-polig	95-	190	X - 44±3

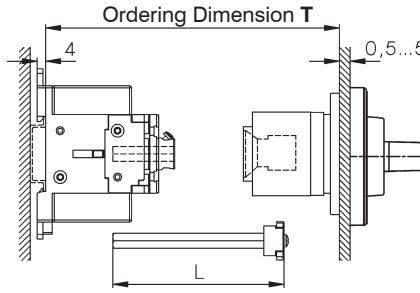

**4-Hole Mounting**  
**LTS.. V(HN).. (3, 4-pole)**



Type		T min	T max	L	Type	T min	T max
LTS20-80 V..		111 -	190	T - 60±3	LT160 V..	120 -	450
LTS85-125 V..		115 -	190	T - 64±3			

greater X- and T-Dimensions (max. 380mm for LTS..) on request

## Switch Disconnecter, Base Mounting with Door Clutch for Hole Mounting Depth X is adjustable (delivered with T<sub>max</sub> see above), IP66, cUL<sub>us</sub> Type 4X

	max. padlocks	AC21 690V	AC23 3x400V	Plate	Type	Pack pcs.	Weight kg/pcs.	
<b>On-Off Switches 3-pole</b>								
		20A	<b>7,5kW</b>	64 □ <sup>1)</sup>	LTS20 V A3	1	0,20	
			25A	<b>10kW</b>	64 □ <sup>1)</sup>	LTS25 V A3	1	0,20
			32A	<b>12,5kW</b>	64 □ <sup>1)</sup>	LTS32 V A3	1	0,20
			40A	<b>16kW</b>	64 □ <sup>1)</sup>	LTS40 V A3	1	0,20
			63A	<b>22kW</b>	64 □ <sup>1)</sup>	LTS63 V A3	1	0,24
			80A	<b>22kW</b>	64 □ <sup>1)</sup>	LTS80 V A3	1	0,24
			85A	<b>30kW</b>	64 □ <sup>1)</sup>	LTS85 V A3	1	0,40
			100A	<b>37kW</b>	64 □ <sup>1)</sup>	LTS100 V A3	1	0,40
			125A	<b>45kW</b>	64 □ <sup>1)</sup>	LTS125 V A3	1	0,40
			160A	<b>55kW</b>	88 □	LT160 V T300	1	1,38
<b>On-Off Switches 4-pole</b>								
		20A	<b>7,5kW</b>	64 □ <sup>1)</sup>	LTS20 V A4	1	0,21	
			25A	<b>10kW</b>	64 □ <sup>1)</sup>	LTS25 V A4	1	0,21
			32A	<b>12,5kW</b>	64 □ <sup>1)</sup>	LTS32 V A4	1	0,21
			40A	<b>16kW</b>	64 □ <sup>1)</sup>	LTS40 V A4	1	0,21
			63A	<b>22kW</b>	64 □ <sup>1)</sup>	LTS63 V A4	1	0,28
			80A	<b>22kW</b>	64 □ <sup>1)</sup>	LTS80 V A4	1	0,28
			85A	<b>30kW</b>	64 □ <sup>1)</sup>	LTS85 V A4	1	0,45
			100A	<b>37kW</b>	64 □ <sup>1)</sup>	LTS100 V A4	1	0,45
			125A	<b>45kW</b>	64 □ <sup>1)</sup>	LTS125 V A4	1	0,45
			160A	<b>55kW</b>	88 □	LT160 V T400	1	1,77

**Add-on modules** see page 297

1) Types with padlock device 88<sup>1)</sup> type suffix **88**, ordering example: LTS32 VHN**488** A3, on request

Switch Disconnecter, Base Mounting with Door Clutch for Single-Hole Mounting  
 Depth X is not adjustable, declare depth X when ordering, IP66, cUL<sub>us</sub> Type 4X

	max. padlocks	AC21 690V	AC23 3x400V	Plate	Type	Pack pcs.	Weight kg/pcs.
<b>On-Off Switches 4-pole</b>							
		20A	<b>7,5kW</b>	64 □	LTS20 VZ A4 X..	1	0,18
		25A	<b>10kW</b>	64 □	LTS25 VZ A4 X..	1	0,18
		32A	<b>12,5kW</b>	64 □	LTS32 VZ A4 X..	1	0,18
		40A	<b>16kW</b>	64 □	LTS40 VZ A4 X..	1	0,18
		63A	<b>22kW</b>	64 □	LTS63 VZ A4 X..	1	0,25
		80A	<b>22kW</b>	64 □	LTS80 VZ A4 X..	1	0,25

Declare depth X when ordering

Type	Preference values for X
LTS.. VZ..	80, 85, 104, 129 (tolerance -3, +1,5)

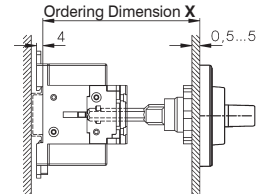

Add-on modules see page 297

Switch Disconnectors for Distribution Boards, IP40, cUL<sub>us</sub> Open Type

	max. padlocks	AC21 690V	AC23 3x400V	Plate	Type	Pack pcs.	Weight kg/pcs.
<b>On-Off Switches 3-pole</b>							
		20A	<b>7,5kW</b>	52x45	LTS20 SMA A3	1	0,15
		25A	<b>10kW</b>	52x45	LTS25 SMA A3	1	0,15
		32A	<b>12,5kW</b>	52x45	LTS32 SMA A3	1	0,15
		40A	<b>16kW</b>	52x45	LTS40 SMA A3	1	0,15
		63A	<b>22kW</b>	52x45	LTS63 SMA A3	1	0,17
		80A	<b>22kW</b>	52x45	LTS80 SMA A3	1	0,17
		85A	<b>30kW</b>	78x45	LTS85 SMA A3	1	0,37
		100A	<b>37kW</b>	78x45	LTS100 SMA A3	1	0,37
	125A	<b>45kW</b>	78x45	LTS125 SMA A3	1	0,37	

	max. padlocks	AC21 690V	AC23 3x400V	Plate	Type	Pack pcs.	Weight kg/pcs.
<b>On-Off Switches 4-pole</b>							
		20A	<b>7,5kW</b>	52x45	LTS20 SMA A4	1	0,16
		25A	<b>10kW</b>	52x45	LTS25 SMA A4	1	0,16
		32A	<b>12,5kW</b>	52x45	LTS32 SMA A4	1	0,16
		40A	<b>16kW</b>	52x45	LTS40 SMA A4	1	0,16
		63A	<b>22kW</b>	52x45	LTS63 SMA A4	1	0,21
		80A	<b>22kW</b>	52x45	LTS80 SMA A4	1	0,21
		85A	<b>30kW</b>	78x45	LTS85 SMA A4	1	0,42
		100A	<b>37kW</b>	78x45	LTS100 SMA A4	1	0,42
	125A	<b>45kW</b>	78x45	LTS125 SMA A4	1	0,42	

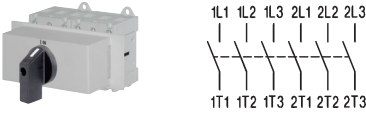

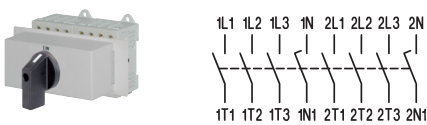





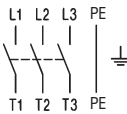

	max. padlocks	AC21 690V	AC23 3x400V	Plate	Type	Pack pcs.	Weight kg/pcs.
<b>On-Off Switches 6-pole</b>							
		20A	<b>7,5kW</b>	52x45	LTS20 SMA A6	1	0,29
		25A	<b>10kW</b>	52x45	LTS25 SMA A6	1	0,29
		32A	<b>12,5kW</b>	52x45	LTS32 SMA A6	1	0,29
		40A	<b>16kW</b>	52x45	LTS40 SMA A6	1	0,29
		63A	<b>22kW</b>	97x45	LTS63 SMA A6	1	0,34
		80A	<b>22kW</b>	97x45	LTS80 SMA A6	1	0,34

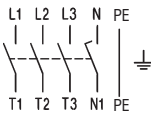
	max. padlocks	AC21 690V	AC23 3x400V	Plate	Type	Pack pcs.	Weight kg/pcs.
<b>On-Off Switches 8-pole</b>							
		20A	<b>7,5kW</b>	97x45	LTS20 SMA A8	1	0,31
		25A	<b>10kW</b>	97x45	LTS25 SMA A8	1	0,31
		32A	<b>12,5kW</b>	97x45	LTS32 SMA A8	1	0,31
		40A	<b>16kW</b>	97x45	LTS40 SMA A8	1	0,31
		63A	<b>22kW</b>	126x45	LTS63 SMA A8	1	0,42
		80A	<b>22kW</b>	126x45	LTS80 SMA A8	1	0,42

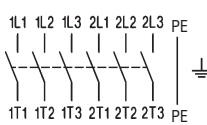
	max. padlocks	AC21 690V	AC23 3x400V	Plate	Type	Pack pcs.	Weight kg/pcs.
<b>Changeover Switches 3-pole</b>							
		20A	<b>7,5kW</b>	97x45	LTS20 SMA U3	1	0,30
		25A	<b>10kW</b>	97x45	LTS25 SMA U3	1	0,30
		32A	<b>12,5kW</b>	97x45	LTS32 SMA U3	1	0,30
		40A	<b>16kW</b>	97x45	LTS40 SMA U3	1	0,30
		63A	<b>22kW</b>	97x45	LTS63 SMA U3	1	0,35

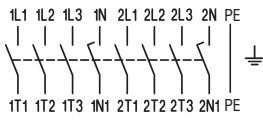

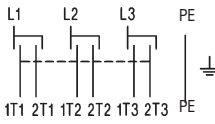

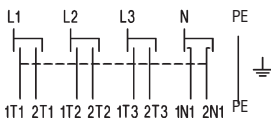







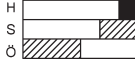

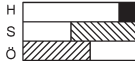
	max. padlocks	AC21 690V	AC23 3x400V	Plate	Type	Pack pcs.	Weight kg/pcs.
<b>Changeover Switches 4-pole</b>							
		20A	<b>7,5kW</b>	97x45	LTS20 SMA U4	1	0,32
		25A	<b>10kW</b>	97x45	LTS25 SMA U4	1	0,32
		32A	<b>12,5kW</b>	97x45	LTS32 SMA U4	1	0,32
		40A	<b>16kW</b>	97x45	LTS40 SMA U4	1	0,32
		63A	<b>22kW</b>	126x45	LTS63 SMA U4	1	0,43

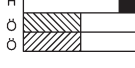
# Switch Disconnectors in Plastic Enclosure IP66, Type 4X



	AC21 690V	AC23 3x400V	Plate	Type	Pack pcs.	Weighth kg/pcs.
<b>On-Off Switches 3-pole</b>						
 	20A	<b>7,5kW</b>	64 □	LTS20 PF(L <sup>1)</sup> ) A3	1	0,30
	25A	<b>10kW</b>	64 □	LTS25 PF(L <sup>1)</sup> ) A3	1	0,30
	32A	<b>12,5kW</b>	64 □	LTS32 PF(L <sup>1)</sup> ) A3	1	0,30
	40A	<b>16kW</b>	64 □	LTS40 PF(L <sup>1)</sup> ) A3	1	0,30
	63A	<b>22kW</b>	64 □	LTS63 PFL A3	1	0,58
	80A	<b>22kW</b>	64 □	LTS80 PFL A3	1	0,58
<b>On-Off Switches 4-pole</b>						
 	20A	<b>7,5kW</b>	64 □	LTS20 PF(L <sup>1)</sup> ) A4	1	0,31
	25A	<b>10kW</b>	64 □	LTS25 PF(L <sup>1)</sup> ) A4	1	0,31
	32A	<b>12,5kW</b>	64 □	LTS32 PF(L <sup>1)</sup> ) A4	1	0,31
	40A	<b>16kW</b>	64 □	LTS40 PF(L <sup>1)</sup> ) A4	1	0,31
	63A	<b>22kW</b>	64 □	LTS63 PFL A4	1	0,62
	80A	<b>22kW</b>	64 □	LTS80 PFL A4	1	0,62
<b>On-Off Switches 6-pole</b>						
 	20A	<b>7,5kW</b>	64 □	LTS20 PFL A6	1	1,39
	25A	<b>10kW</b>	64 □	LTS25 PFL A6	1	1,39
	32A	<b>12,5kW</b>	64 □	LTS32 PFL A6	1	1,39
	40A	<b>16kW</b>	64 □	LTS40 PFL A6	1	1,39
	63A	<b>22kW</b>	64 □	LTS63 PFL A6	1	1,42
	80A	<b>22kW</b>	64 □	LTS80 PFL A6	1	1,42
knockoutlets M50/40 +PF3/M50 on request						
<b>On-Off Switches 8-pole</b>						
 	20A	<b>7,5kW</b>	64 □	LTS20 PFL A8	1	1,44
	25A	<b>10kW</b>	64 □	LTS25 PFL A8	1	1,44
	32A	<b>12,5kW</b>	64 □	LTS32 PFL A8	1	1,44
	40A	<b>16kW</b>	64 □	LTS40 PFL A8	1	1,44
	63A	<b>22kW</b>	64 □	LTS63 PFL A8	1	1,50
	80A	<b>22kW</b>	64 □	LTS80 PFL A8	1	1,50
knockoutlets M50/40 +PF3/M50 on request						
<b>Changeover Switches 3-pole</b>						
 	20A	<b>7,5kW</b>	64 □	LTS20 PFL U3	1	1,39
	25A	<b>10kW</b>	64 □	LTS25 PFL U3	1	1,39
	32A	<b>12,5kW</b>	64 □	LTS32 PFL U3	1	1,39
	40A	<b>16kW</b>	64 □	LTS40 PFL U3	1	1,39
	63A	<b>22kW</b>	64 □	LTS63 PFL U3	1	1,42
	<b>Changeover Switches 4-pole</b>					
 	20A	<b>7,5kW</b>	64 □	LTS20 PFL U4	1	1,44
	25A	<b>10kW</b>	64 □	LTS25 PFL U4	1	1,44
	32A	<b>12,5kW</b>	64 □	LTS32 PFL U4	1	1,44
	40A	<b>16kW</b>	64 □	LTS40 PFL U4	1	1,44
	63A	<b>22kW</b>	64 □	LTS63 PFL U4	1	1,50

1) PFL.... larger enclosure













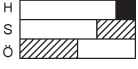

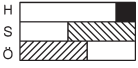
## Add-on Modules for Main Switches, Panel Mounting and Single Hole Mounting

		for switch	Type	Pack pcs.	Weight kg/pcs.	
	<b>4<sup>th</sup> Add-on Neutral Switching Pole</b>					
			LTS20 ... to LTS40 ... LTS63 ... , LTS80 ...	N40E N80E	1 1	0,035 0,042
	<b>Aux. Contact Block 1NO + 1NC</b>					
			LTS20 ... to LTS125 ...	LH11	1	0,02
	<b>Aux. Contact Block 1NO + 1NC Overlapping</b>					
			LTS20 ... to LTS125 ...	LH11X	1	0,02
	<b>Aux. Contact Block 2NC</b>					
			LTS20 ... to LTS125 ...	LH20V/02E	1	0,02
	<b>PE-Terminal</b>					
			LTS20 ... to LTS80 ... LT125 E.. to LT160 E..	PE80E LTXX-E/E	1 1	0,04 0,2
	<b>N-Terminal</b>					
			LTS20 ... to LTS80 ... LT125 E.. to LT160 E..	PEN80E LTXX-N/E	1 1	0,04 0,2
	<b>Terminal Cover 3-pole</b>					
			LTS20 ... to LTS80 ... LTS85.. to LTS125. LT125.. to LT160..	KLAD70 KLAD125 XX-KLAD3	1 1 1	0,005 0,01 0,02
	<b>Terminal Cover for 4<sup>th</sup> pole</b>					
			Mains Load circuit	LTS20 ... to LTS80.. LTS20 ... to LTS80.. KLAD70N KLAD70NI	1 1	0,002 0,002
	<b>Terminal Cover 4-pole</b>					
			LTS85.. to LTS125. LT125.. to LT160..	KLAD125 XX-KLAD4	1 1	0,01 0,02

## Accessories for Main Switches, Panel Mounting, Single Hole and Base Mounting

		for switch	Type	Pack pcs.	Weight kg/pcs.	
	<b>Additional Escutcheon Plate Yellow, Marked with: HAUPTSCHALTER</b>					
		for plate 48 <sup>r</sup> for plate 64 <sup>r</sup>	LTS.. .HN1.. LTS.. .HN4..	A91501 E91501	1 1	0,003 0,005
	<b>Additional Escutcheon Plate Yellow, Marked with: MAIN SWITCH</b>					
		for plate 48 <sup>r</sup> for plate 64 <sup>r</sup>	LTS.. .HN1.. LTS.. .HN4..	A91524 E91524	1 1	0,003 0,005
	<b>Tab Terminal 6,3 x 0,8mm</b>					
		LTS20 ... bis LTS40 ...	LG11073	10	0,001	

## Add-on Modules for Main Switches, Base and Rail Mounting

		for switch	Type	Pack pcs.	Weight kg/pcs.	
	<b>4<sup>th</sup> Add-on Neutral Switching Pole</b>					
		LTS20 ... , LTS40 ... LTS63 ... , LTS80 ...	N40V N80V	1 1	0,035 0,042	
	<b>Aux. Contact Block 1NO + 1NC</b>					
		LTS20 ... to LTS125 ...	LH11	1	0,02	
	<b>Aux. Contact Block 1NO + 1NC Overlapping</b>					
		LTS20 ... to LTS125 ...	LH11X	1	0,02	
	<b>Aux. Contact Block 2NO</b>					
		LTS20 ... to LTS80 ...	LH20V/02E	1	0,02	
	<b>PE-Terminal</b>					
		LTS20 ... to LTS80 ... LT125 .. to LT160 ..	PE80V LTXX-E/V	1 1	0,04 0,2	
	<b>N-Terminal</b>					
		LTS20 ... to LTS80 ... LT125 .. to LT160 ..	PEN80V LTXX-N/V	1 1	0,04 0,2	
	<b>Terminal Cover 3-pole</b>					
		LTS20 ... to LTS40 ...	KLAD40	1	0,005	
		LTS63 ... to LTS80 ...	KLAD70	1	0,005	
		LTS85.. to LTS125.	KLAD125	1	0,01	
		LT125.. to LT160..	XX-KLAD3	1	0,02	
	<b>Terminal Cover for 4<sup>th</sup> pole</b>					
	Mains Load circuit	LTS63.., LTS80.. LTS63.., LTS80..	KLAD70N KLAD70NI	1 1	0,002 0,002	
	<b>Terminal Cover 4-pole</b>					
		LTS20 ... to LTS40 ...	KLAD40	1	0,005	
		LTS85.. to LTS125.	KLAD125	1	0,01	
		LT125.. to LT160..	XX-KLAD4	1	0,02	
	<b>Additional Cover SMA for</b>					
	4. Pole	N40V, N80V	grey	LG8628-2	1	0,047
	Aux. Contacts	LH..	yellow	LG8628-7	1	0,047
	PE and N-Terminal	PE80V, PEN80V				

# Technical Data

Data according to IEC 947-3, IEC 947-5-1, VDE 0660, EN 60947-3, EN 60947-5-1

Type	LTS20	LTS25	LTS32	LTS40	LTS63	LTS80	LTS85	LTS100	LTS125	LT160											
<b>Main contacts</b>																					
Rated thermal current $I_{th}$ open	A	20	25	32	40	63	80	85	100	125	160										
Rated thermal current $I_{the}$ enclosed	A	20	25	32	40	63	80	85	100	110	160										
Rated insulation voltage $U_i$ <sup>1)</sup>	V	690	690	690	690	690	690	1000 <sup>3)</sup>	1000 <sup>3)</sup>	1000 <sup>3)</sup>	1000 <sup>3)</sup>										
Rated operational current $I_e$ AC21A	A	20	25	32	40	63	80	85	100	125	160										
Rated operational voltage $U_e$ max. AC21A	V	690	690	690	690	690	690	1000	1000	1000	690										
Making capacity $I_{eff}$ 3x380-440V	A	160	190	220	300	370	440	600	725	850	1050										
Breaking capacity 3x220-240V	A	160	180	200	250	330	380	480	580	680	900										
3x380-440V	A	160	180	200	250	330	380	480	580	680	850										
3x660-690V	A	80	110	140	170	190	220	250	330	420	340										
Disconnection property performed up to	V	690	690	690	690	690	690	1000	1000	1000	1000										
Motor Switch AC3 3x400V	A	12	16	23	30	37	37	45	60	72	85										
Motor Switch AC3 3x220-240V	kW	3	4	5,5	7,5	11	11	15	18,5	22	30										
Direct switching of single motors 3x380-440V	kW	5,5	7,5	11	15	18,5	18,5	22	30	37	45										
3x660-690V	kW	5,5	7,5	11	15	18,5	18,5	22	30	37	37										
Main Switch AC23 3x400V	A	16	20	25	32	45	45	60	72	85	110										
Motor Switch, AC23A, 3x220-240V	kW	4	5,5	7,5	9	15	15	18,5	22	30	30										
Main Switch, AC23B 3x380-440V	kW	7,5	10	12,5	16	22	22	30	37	45	55										
Safety Switch 3x660-690V	kW	5,5	7,5	11	15	18,5	18,5	22	30	37	37										
Rated conditional short-circuit current 400V	kA <sub>eff</sub>	10	10	10	10	10	10	10	10	5	30										
Max. fuse size gL (gG) 400V	A	25	35	40	40	63	80	100	100	125	160										
Rated conditional short-circuit current 690V	kA <sub>eff</sub>	10	5	3	1	5	1,5	10	10	5	-										
Max. fuse size gL (gG) 690V	A	20	25	32	40	63	80	85	100	125	-										
Mechanical life	x10 <sup>3</sup>	200	200	200	200	100	100	100	100	100	100										
Rated short-time withstand current (1sec. current)	A	250	300	400	500	600	850	1000	1200	1500	3000										
Power loss per P/pole [W]	E, Z	0,322	0,503	0,824	1,288	2,739	4,416	3,851	5,330	8,328	-										
pole AC21 = $I_{th}$	V, SMA, PF	0,364	0,569	0,933	1,458	2,739	4,416	3,851	5,330	8,328	-										
	R/pole [mOhm]	0,805	0,805	0,805	0,805	0,690	0,690	0,533	0,533	0,533	-										
	V, SMA, PF	0,911	0,911	0,911	0,911	0,690	0,690	0,533	0,533	0,533	-										
<b>Maximum ambient temperature</b> Operation open	-40°C to +60°C (90°C) <sup>5)</sup>										+60°C										
enclosed											-40°C to +40°C										+40°C
Storage																					-50°C to +90°C
<b>Cable cross sections</b> mm <sup>2</sup>	0,5 - 10		1 - 25 <sup>4)</sup>		4 - 50		max.95														
solid or stranded	AWG 20 - 8 (10)		16 - 3 (10)		10 - 00 (10)		max.3/0														
flexible	mm <sup>2</sup> 0,5 - 6		4 - 16 <sup>4)</sup>		10 - 35		max.70														
	AWG 20 - 10		16 - 6		8 - 2		max.2/0														
flexible (+ multicore cable end)	mm <sup>2</sup> 0,5 - 6		0,75 - 16 <sup>4)</sup>		6 - 35		max.50														
	AWG 20 - 10		16 - 6		8 - 2		max.1/0														
Size of terminal screw	M3,5		M5		M6		M10														
Tightening torque	Nm 1,7 - 2,3		2,8 - 4		1,7 - 4,5		14														
<b>Auxiliary contacts</b>																					
Rated insulation voltage $U_i$ <sup>1)</sup>	V	690				690		690		690											
Rated thermal current $I_{th}$ , $I_{the}$	A	10				10		10		16											
Switching capacity AC15 380-450V	A	2,5/1,5				2,5/1,5		2,5/1,5		6/4											
DC13 60-110V	A	2/0,4				2/0,4		2/0,4		-											
Rated conditional short-circuit current	kA <sub>eff</sub>	3				3		3		3											
Max. short circuit protection gL (gG)	A	10				10		10		16											
<b>Cable cross sections</b> mm <sup>2</sup>	0,75 - 2,5		0,75 - 2,5		0,75 - 2,5		max.4														
solid or stranded	AWG 14 - 12		14 - 12		14 - 12		max.12														
flexible (+ multicore cable end)	mm <sup>2</sup> 0,75 - 2,5 (1,5)		0,75 - 2,5 (1,5)		0,75 - 2,5 (1,5)		max.2,5														
	AWG 18 - 14		18 - 14		18 - 14		max.14														
<b>Data according to UL and cUL</b>																					
Type	LTS20	LTS25	LTS32	LTS40	LTS63	LTS80	LTS85	LTS100	LTS125	LT160											
Rated voltage	V	600	600	600	600	600	600	600	600	600											
Ampere-Rating "General use"	A	20	25	32	40	63	80	85	100	125											
DOL-Rating 3-phase 110-120V	HP	1	1,5	2	2	3	5	7,5	10	15											
220-240V	HP	3	5	5	5	10	10	20	25	30											
440-480V	HP	7,5	10	10	10	20	20	40	50	60											
550-600V	HP	10	10	15	15	25	25	50	60	60											
DOL-Rating 1-phase 110-120V	HP	1	1	1	1	2	2	3	5	7,5											
200-208V	HP	1	2	2	2	3	3	7,5	10	10											
220-240V	HP	2	2	3	3	5	5	10	15	15											
Fuse size (RK5) Manual Motor Controller	A	40	50	50	70	90	110	125	125	125											
5kA / 600V Motor Disconnect	A	40	50	50	50	70	70	125	125	125											
Tightening torque	Nm	1,7-2,3	1,7-2,3	1,7-2,3	1,7-2,3	2,8-4	2,8-4	1,7-4,5	1,7-4,5	1,7-4,5											
	lb.inch	15-20	15-20	15-20	15-20	24-35	24-35	15-40	15-40	15-40											

1) suitable for: earthed-neutral systems, overvoltage category I to III, pollution degree 3 (standard-industry):  $U_{imp} = 6kV$ .

2) Fuse RK1 / 10kA / 600V 3)  $U_{imp} = 8kV$

4) LTS63..U. stranded 16mm<sup>2</sup>, flexible 10mm<sup>2</sup>

5) Derating acc. to cable cross sections

# Dimensions (mm)

## Main Switches, Switch Disconnectors LT(S)..

**Panel mounting LT(S).. E(HN)..**  
ON-OFF Switches 3-pole, 4-pole

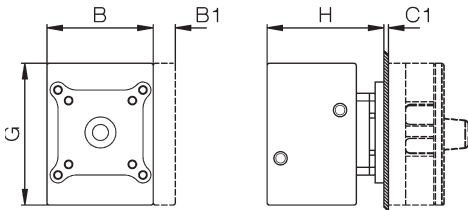

ON-OFF Switches 6-pole, 8-pole  
Changeover Switches 3-pole, 4-pole

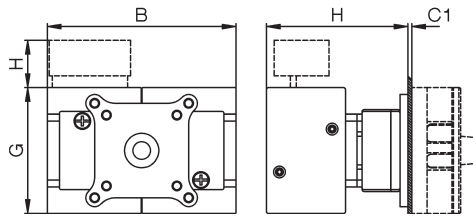

Mounting holes  
Mounting screw: J3631N M=1,2-1,4 Nm

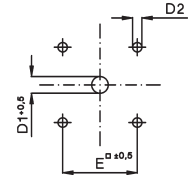

**Single hole mounting LTS.. Z(HN)..**  
ON-OFF Switches 3-pole, 4-pole

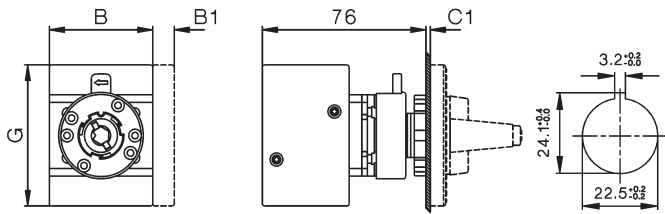

Mounting holes

**Mounting of add-on modules LTS20 - LTS80**  
Panel mounting, Single hole mounting

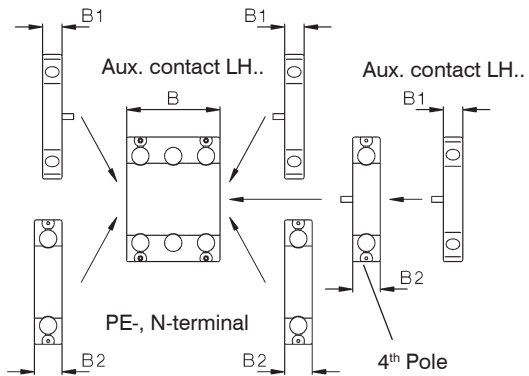

Type	Changeover ON-OFF Escutch. plate or padlock device	3-pole		4-pole		aux. contact B1	4 Pole				3,4-pole						
		A	B	B	B		B	PE B2	C1	D1	D2	E	F	G	3-pole 4-pole X	6-pole 8-pole X	H
LTS20-80..	48 □, SV1	48	48	62,5	-	-	10	14,5	1-5	9	5	36	-	64	54	-	24
LTS20-80..	64 □, SV4, SV164	64	48	62,5	97	126	10	14,5	1-5	9	5	48	-	64	54	74	24
LTS85-125..	64 □, SV4	64	78	78	-	-	10	-	1-5	9	5	48	-	85	60	-	-
LTS85-125..	88 □, SV488	88	78	78	-	-	10	-	1-5	9	6	68	-	85	60	-	-
LT160	88 □, SV34	88	112	150	224	-	-	-	1-4	13-17	6	68	49,3	108	96	98	-

**Escutcheon plate**  
48 □

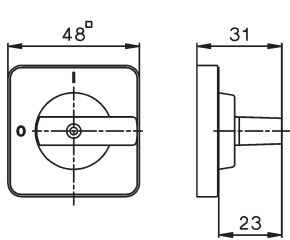

64 □

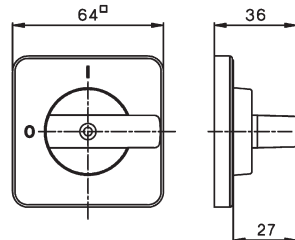

**Padlock devices**  
SV1

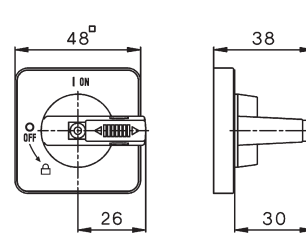

SV164

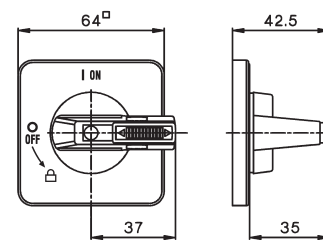

**Padlock devices**  
SV4

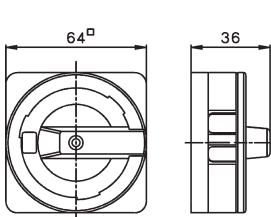

SV488

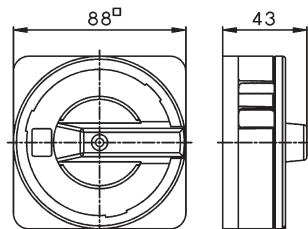

SV34

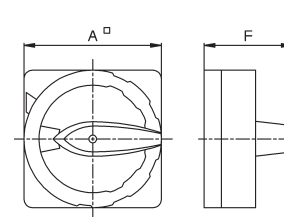

**Extended Switch Shaft**  
+ VW"x"

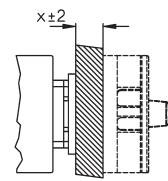



# Dimensions (mm)

## Main Switches, Switch Disconnectors LT(S)..

**Base mounting LTS.. VZV(HN)..**  
ON-OFF Switches 3-pole, 4-pole

**L = X - 40 ± 3** for LTS20 - 80  
**L = X - 44 ± 3** for LTS85 - 125

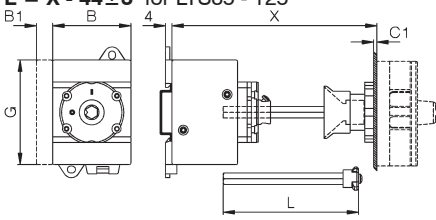

6-pole  
for LTS20 - 40 only  
**L = X - 40 ± 3**

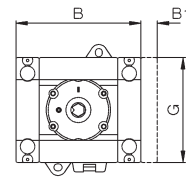

ON-OFF Switches 6-pole, 8-pole  
Changeover Switches 3-pole, 4-pole  
**L = X - 60 ± 3**

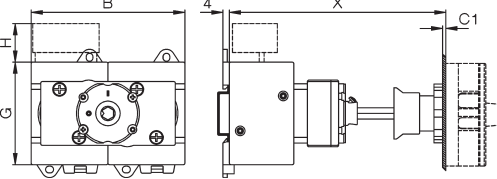

Mounting holes

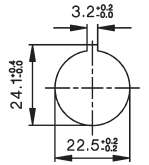

**Base mounting LT(S).. V(HN)..**  
ON-OFF Switches 3-pole, 4-pole

**L = T - 60 ± 3** for LTS20 - 80  
**L = T - 64 ± 3** for LTS85 - 125

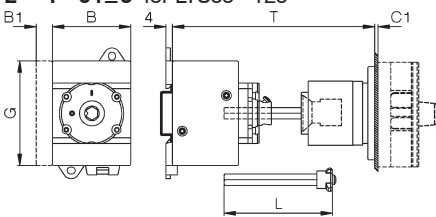

6-pole  
for LTS20 - 40 only  
**L = T - 60 ± 3**

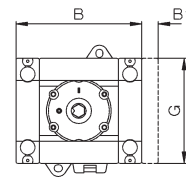

ON-OFF Switches 6-pole, 8-pole  
Changeover Switches 3-pole, 4-pole  
**L = T - 80 ± 3** for LTS20 - 80 only

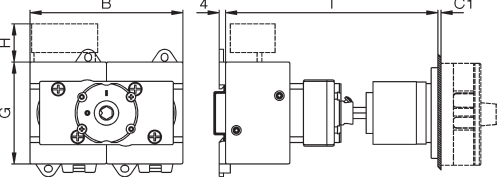

Mounting holes

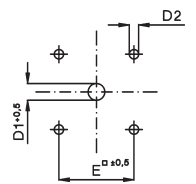

**Base mounting LTS.. VZ(HN)..**  
ON-OFF Switches 3-pole, 4-pole  
Preference values for X: 80, 85, 104, 129

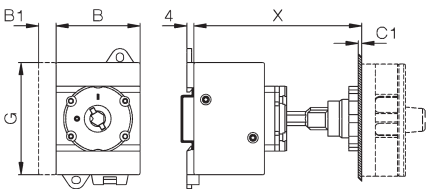

6-pole  
for LTS20 - 40 only

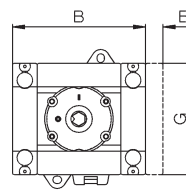

ON-OFF Switches 6-pole, 8-pole  
Changeover Switches 3-pole, 4-pole

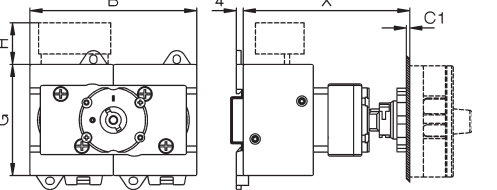

Mounting holes

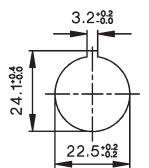

Type	Changeover ON-OFF Escutch. plate or padlock device	3-pole				3,4-pole		aux. contact B1	4 Pole PE		C1	D1	D2	D3	E	G	K	K1	J
		A	B	B	B	B	B		H	B2									
LTS20 - 40	64 □, SV4, SV164	64	48	48	77	97	10	14,5	24	1-5	9	5	M4	48	64	25	48	70	
LTS63, 80	64 □, SV4, SV164	64	48	62,5	97	126	10	14,5	24	1-5	9	5	M4	48	64	25	48	70	
LTS85-125..	64 □, SV4	64	78	78	-	-	10	-	-	1-5	9	5	M4	48	85	38	-	90	
LT125/160	88 □, SV34	88	112	150	224	-	-	-	-	1-4	13/27 <sup>2)</sup>	6	M6	68	108	36	-	120	

**Base mounting**  
ON-OFF Switches LTS20 - LTS80  
3-pole, 4-pole  
6-pole LTS20 - 40

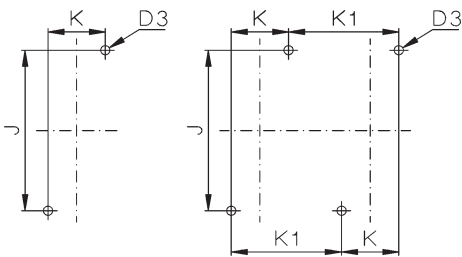

**LTS85-125, LT160**  
3-pole, 4-pole

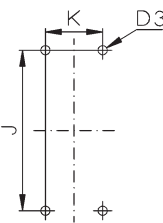

**Mounting of Accessories LTS20 - LTS80**  
Base mounting, for distribution boards

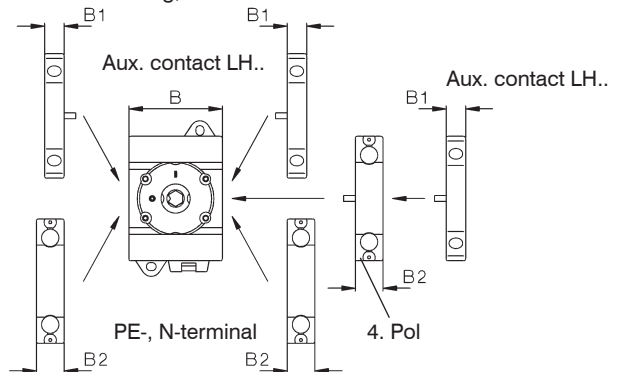

1) Ø 22-25 for LT80(100) VH(N)34 .. only  
2) Ø 26-30 for LT125(160) VH(N)34 .. only

## Dimensions (mm)

### Main Switches, Switch Disconnectors LT(S)..

#### Installation cover LT(S).. SMA(HN)..

ON-OFF Switches 3-pole, 4-pole

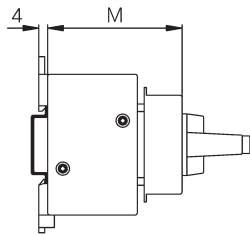
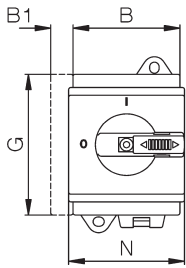

ON-OFF Switches 6-pole  
for LTS20 - 40 only

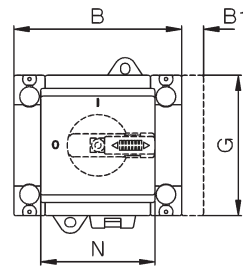

ON-OFF Switches 6-pole, 8-pole  
Changeover Switches 3-pole, 4-pole

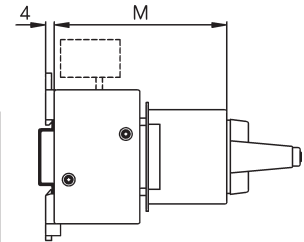
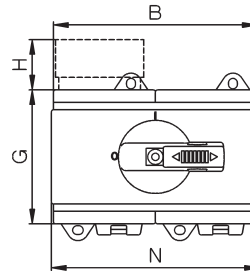

Type	padlock device	Changeover ON-OFF						G	3,4-pole			3,4-pole			H
		3-pole	4-pole	6-pole	8-pole	aux. contact	4.pole PE		3-pole 4-pole	6-pole	8-pole	3-pole 4-pole	6-pole	8-pole	
		B	B	B	B	B1	B2	M		M	M	N	N	N	
LTS20 - 40	SV1, SV164	48	48	77	96	10	14,5	64	60	60	74	52	52	97 <sup>2)</sup>	24
LTS63, 80	SV1, SV164	48	62,5	96	125	10	14,5	64	60	79	79	52	97 <sup>2)</sup>	126 <sup>1)</sup>	-
LTS85-125..	SV164	78	78	-	-	10	-	85	60	-	-	78	-	-	-

#### Installation cover with low height handle LTS SMAHN1.. +SV1N

Main switch 3-pole, 4-pole

LTS20 - LTS80

Padlock device SV1

Padlock device SV164

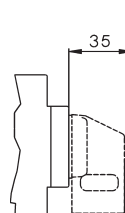
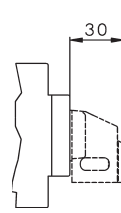
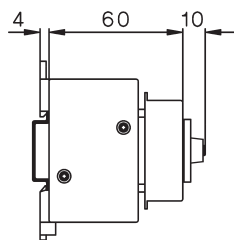
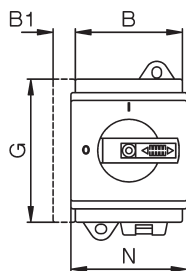

1) Original cover

2) Remove cover parts

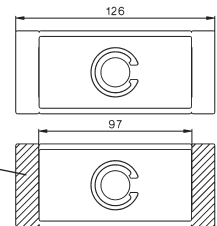

### Maintenance and Safety Switches LT(S)..PF..

Type	pole	size	A	B	C	D1	D2	E	F	H
LTS20 PFH.. A. - LTS40 PFH.. A. <sup>3)</sup>	3, 4	PF1	130	98	120	2x25,5/20,5	-	75	100	76
LTS20 PFLH.. A., LTS40 PFLH A. <sup>3)</sup>	3, 4	PFL	180	98	170	2x25,5/20,5 / 16,5/12,5-	-	75	150	76
LTS20 PFLH.. A. - LTS40 PFLH.. A. <sup>4)</sup>	6	PFL2	200	140	188,5	40,5/32,5+16,5+12,5 -	-	100	160	86
LTS63 PFLH.. A. - LTS80 PFLH.. A. <sup>4)</sup>	3, 4	PFL2	200	140	188,5	40,5/32,5+16,5+12,5 -	-	100	160	86
LTS85 PFLH.. A. - LTS125 PFLH.. A. <sup>5)</sup>	3, 4	PFL2	200	140	188,5	40,5/32,5+16,5+12,5 -	-	100	160	86
suffix + PF3	3, 4	PFL3	240	176	228,5	2x40,5/32,5	-	120	200	120
suffix + PF3/M50	3, 4	PFL3	240	176	228,5	50,5/40,5	-	120	200	120
LTS20 PFLH.. A. - LTS40 PFLH.. A. <sup>5)</sup>	8	PFL3	240	176	228,5	2x40,5/32,5	-	120	200	120
LTS63 PFLH.. A. - LTS80 PFLH.. A. <sup>5)</sup>	6, 8	PFL3	240	176	228,5	2x40,5/32,5	-	120	200	120
suffix + M50	6, 8	PFL3	240	176	228,5	50,5/40,5	-	120	200	120
LT160 PF..	3	PF4	300	200	-	2x50,5	25,5	172	272	172
LT160 PF..	4	PF5	300	280	-	2x50,5	-	254	254	180

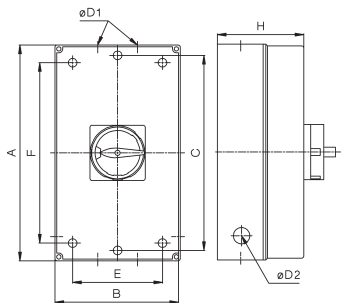

### Switch Disconnectors in Plastic Enclosure LTS..PF..

Type	pole	size	A	B	C	D1	E	F	H
LTS20 PF A., LTS40 PF A. <sup>3)</sup>	3, 4	PF1	130	98	121	2x25,5/20,5	75	100	76
LTS20 PFL A., LTS40 PFL A. <sup>3)</sup>	3, 4	PFL	180	98	170	2x25,5/20,5 / 16,5/12,5	75	150	76
LTS63 PFL A., LTS80 PFL A. <sup>4)</sup>	3, 4	PFL2	200	140	188,5	40,5/32,5+16,5+12,5	100	160	86
suffix + PF3	3, 4	PFL3	240	176	228,5	2x40,5/32,5	120	200	120
suffix + PF3/M50	3, 4	PFL3	240	176	228,5	50,5/40,5	120	200	120

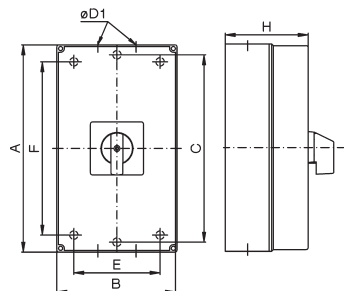

Max. quantity of poles + aux. contacts in enclosure:

3) LTS40 PF. A5 + LH11

4) LTS40 PFL.. A6, LTS80 PFL.. A5 + LH11, LTS125 PFL.. A4 + LH11

5) LTS40 PFL.. A10, LTS40 PFL.. U4 + LH11, LTS80 PFL.. A8, LTS80 PFL.. A6 + LH11, LTS40 PFL.. U3 + LH11, LTS125 PFL.. A4+LH11