

# General Catalogue



Quality made in



D946E193

# Index

Page



## General

|                       |    |
|-----------------------|----|
| Approvals             | 4  |
| Technical Information | 5  |
| Mounting Information  | 9  |
|                       | 10 |



## Micro Contactors

|                            |    |
|----------------------------|----|
| Micro Contactors           | 11 |
| Micro Contactor Relays     | 12 |
| Micro Reversing Contactors | 14 |
| Technical Information      | 18 |
| Dimensions                 | 20 |
|                            | 24 |



## Mini Contactors

|                           |    |
|---------------------------|----|
| Mini Contactors           | 25 |
| Interface Contactors      | 26 |
| Mini Reversing Contactors | 26 |
| Technical Information     | 32 |
| Dimensions                | 33 |
|                           | 36 |



## Contactor Relays

|                       |    |
|-----------------------|----|
| Contactor Relays      | 39 |
| Technical Information | 40 |
| Dimensions            | 40 |
|                       | 44 |



## Contactors

|                                |    |
|--------------------------------|----|
| Contactors Overview            | 45 |
| Contactors, 3-pole             | 46 |
| Contactors, 4-pole             | 48 |
| Capacitor Switching Contactors | 50 |
| Accessories                    | 51 |
| Technical Information          | 52 |
| Dimensions                     | 62 |
|                                | 82 |

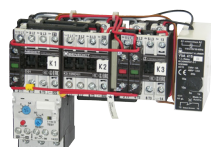

## Starters

|                        |     |
|------------------------|-----|
| Star-Delta Starters    | 91  |
| Reversing Contactors   | 92  |
| Pole Changing Starters | 96  |
| Technical Information  | 98  |
| Dimensions             | 100 |
|                        | 107 |



## D.O.L. Starters

|                       |     |
|-----------------------|-----|
| D.O.L. Starters       | 111 |
| Enclosures            | 112 |
| Accessories           | 113 |
| Technical Information | 113 |
| Dimensions            | 115 |
|                       | 116 |



## Overload Relays

|                         |     |
|-------------------------|-----|
| Thermal Overload Relays | 119 |
| Accessories             | 121 |
| Technical Information   | 123 |
| Dimensions              | 125 |
|                         | 129 |



## Modular Contactors

|                       |     |
|-----------------------|-----|
| Contactors            | 133 |
| Accessories           | 134 |
| Technical Information | 135 |
| Dimensions            | 138 |
|                       | 140 |



## Contactors for DC-Switching Contactors RAST 5

|                             |     |
|-----------------------------|-----|
| Contactors for DC-Switching | 141 |
| Contactors RAST 5           | 145 |

Contactor, Motor-Starters

Circuit Breakers

Manual Motor-Starters

Switches

AC-Main Switches

DC-Switch Disconnectors

Push Buttons

Representatives, Suppliers

## General

### Test Authorities, Registration Mark, Approvals

Low voltage switchgear from Benedict GmbH is built and tested to national and international specifications. All devices suit all important specifications without any test obligation, like VDE, BS and also relative to IEC Recommendations and to European Standards like IEC 947 and EN 60947. It is for this reason of our Low voltage switchgear is used all over the world. In order to provide special versions, limitations to the max. voltages, currents and power ratings or special markings are sometimes necessary.

### Quality Control System

Since November 1991 Benedict GmbH has been certified according to the quality control system **ÖNORM EN ISO 29001**. The target of the ISO-certification is, to grant the customer the quality of the performance of his supplier, who is audited in accordance with this standard.

### CE-Marking



The manufacturer has to sign his products with the CE-Marking. With the CE-Marking the manufacturer confirms the accordance with the different EEC Directives. The CE-Marking is absolutely necessary to sell the products in the EEC.

Below you find the EEC Directives concerning our products.

Low Voltage Directive 2006/95/EC

EMC Directive 2004/108/EC

RoHS + WEEE 2002/95/EC + "002/96/EC

| Country  | North America       | Russia         | China          |
|--|---------------------|----------------|----------------|
| State deputy or private examination (state admitted) | UL<br>Canada, USA   | EAC            | CCC            |
| Label marking of examination boards                  | Listed<br>Component |                |                |
| Duty of approvals                                    | all switchgear      | all switchgear | all switchgear |

### Explanations for choice and supply of low voltage switchgear in Canada and USA

#### Marking of auxiliary contacts

At several devices in UL-data are two voltages for auxiliary contacts mentioned (e. g.: 600 volts at same potential, 150 volts at different potentials). That means, if the voltage is higher than 150 volts, the control voltage applied to input terminals must be at the same potential.

Low voltage switchgear for auxiliary circuits (e. g. contactor relays, control units, auxiliary contacts in general) usually approved for "Heavy Duty" or "Standard Duty" UL and besides these marked with the admissible max. voltage or with short codes (see table).

| Marking of auxiliary contacts according to CSA and UL | Max. rated values per pole |                |         | Cont. Current A | Contact Rating Code Designation |
|---|----------------------------|----------------|---------|-----------------|---------------------------------|
|   | Voltage V                  | Current Make A | Break A |                 |                                 |
| Heavy Duty (HD or HVY DTY)                            | AC 120                     | 60             | 6       | 10              | A150                            |
|   | AC 240                     | 30             | 3       | 10              | A300                            |
|   | AC 480                     | 15             | 1,5     | 10              | A600                            |
|   | AC 600                     | 12             | 1,2     | 10              | A600                            |
|   | DC 125                     | 2,2            | 2,2     | 10              | N150                            |
|   | DC 250                     | 1,1            | 1,1     | 10              | N300                            |
|   | DC 600                     | 0,4            | 0,4     | 10              | N600                            |
| Standard Duty (SD or STD DTY)                         | AC 120                     | 30             | 3       | 5               | B150                            |
|   | AC 240                     | 15             | 1,5     | 5               | B300                            |
|   | AC 480                     | 7,5            | 0,75    | 5               | B600                            |
|   | AC 600                     | 6              | 0,6     | 5               | B600                            |
|   | DC 125                     | 1,1            | 1,1     | 5               | P150                            |
|   | DC 250                     | 0,55           | 0,55    | 5               | P300                            |
|   | DC 600                     | 0,2            | 0,2     | 5               | P600                            |
| -   | AC 120                     | 15             | 1,5     | 2,5             | C150                            |
|   | AC 240                     | 7,5            | 0,75    | 2,5             | C300                            |
|   | AC 480                     | 3,75           | 0,375   | 2,5             | C600                            |
|   | AC 600                     | 3              | 0,3     | 2,5             | C600                            |
|   | DC 125                     | 0,55           | 0,55    | 2,5             | Q150                            |
|   | DC 250                     | 0,27           | 0,27    | 2,5             | Q300                            |
|   | DC 600                     | 0,1            | 0,1     | 2,5             | Q600                            |
| -   | AC 120                     | 3,6            | 0,6     | 1               | D150                            |
|   | AC 240                     | 1,8            | 0,3     | 1               | D300                            |
|   | DC 125                     | 0,22           | 0,22    | 1               | R150                            |
|   | DC 250                     | 0,11           | 0,11    | 1               | R300                            |
| -   | AC 120                     | 1,8            | 0,3     | 0,5             | E150                            |

#### Discernment at UL-Standards

##### Recognized Component Industrial Control Equipment

UL issues yellow "Guide cards" with Guide- and File-No.

Devices have permission to be marked with on the label



##### Listed Industrial Control Equipment

UL issues white "Guide cards" with Guide- and File-No.

Devices have to be marked with the "UL-Listing Mark"



Devices as components approved for "factory wiring": devices for employment in control panels, when they are selected, mounted and wired according to the charging conditions by skilled worker.

Devices approved for "field wiring",







- a) devices for employment in control panels, when they are mounted and wired by skilled worker.
- b) devices for retail in USA

Valid UL-Standards:  
UL 508 "Standard for Industrial Control Equipment" (partly limited)

Valid UL-Standards:  
UL 508 "Standard for Industrial Control Equipment" (unlimited)







Are devices approved as "Listed Equipment" the approval is also valid for using as "Recognized Component" .

# Approvals

| Country  | North America   |   | Switzerland  | Europe  | Russia<br>EAC   | China   | CENELEC<br>CB-Certificates |
|--|---|---|--|---|---|---|----------------------------|
| Type   | UL<br> |  | SEV<br> |  |  |  |                            |
| <b>Micro Contactor Relays, Micro Contactors K0, Micro Reversing Contactors and Accessories</b> |   |   |  |   |   |   |                            |
| K0-04D..   | o   | -   | -  | o   | -   | -   | -                          |
| K0-05D..   | o   | -   | -  | o   | -   | o   | -                          |
| K0W05D..   | o   | -   | -  | o   | -   | o   | -                          |
| <b>Mini Contactor Relays, Mini Contactors, Mini Reversing Contactors K1 and Accessories</b>    |   |   |  |   |   |   |                            |
| K1-07D..(=)  | o   | -   | -  | o   | o   | -   | o                          |
| K1-07L..(=)  | -   | o   | -  | o   | o   | -   | o                          |
| K1-07F..(=)  | -   | o   | -  | o   | o   | -   | -                          |
| K1-09D..(=)  | o   | -   | -  | o   | o   | o   | o                          |
| K1-09L..(=)  | -   | o   | -  | o   | o   | o   | o                          |
| K1-09F..(=)  | -   | o   | -  | o   | o   | o   | -                          |
| K1-12D..(=)  | o   | -   | -  | o   | o   | o   | -                          |
| K1W09D01(=)  | o   | -   | -  | o   | o   | o   | -                          |
| K1W12D01(=)  | o   | -   | -  | o   | o   | o   | -                          |
| K1W09L01(=)  | -   | o   | -  | o   | o   | o   | -                          |
| HK..., HKM..   | o   | -   | -  | o   | o   | -   | o                          |
| RC-K1  | o   | -   | -  | o   | o   | -   | -                          |
| <b>Contactor Relays, Contactors Series K3</b>  |   |   |  |   |   |   |                            |
| K3-07ND..(=)   | o   | -   | -  | o   | o   | -   | -                          |
| K3-10N..(=)  | o   | -   | o  | o   | o   | o   | o                          |
| K3-14N..(=)  | o   | -   | o  | o   | o   | o   | o                          |
| K3-18N..(=)  | o   | -   | o  | o   | o   | o   | o                          |
| K3-22N..(=)  | o   | -   | o  | o   | o   | o   | o                          |
| K3-24A..(=)  | o   | -   | o  | o   | o   | o   | o                          |
| K3-32A..(=)  | o   | -   | o  | o   | o   | o   | o                          |
| K3-40A..(=)  | o   | -   | o  | o   | o   | o   | o                          |
| K3-50A..(=)  | o   | -   | o  | o   | o   | o   | o                          |
| K3-62A..(=)  | o   | -   | o  | o   | o   | o   | o                          |
| K3-74A..(=)  | o   | -   | o  | o   | o   | o   | o                          |
| K3-90A..(=)  | o   | -   | -  | o   | o   | o   | -                          |
| K3-115A..(=)   | o   | -   | -  | o   | o   | o   | -                          |
| K3-151A..(=)   | o   | -   | -  | o   | o   | -   | -                          |
| K3-176A..(=)   | o   | -   | -  | o   | o   | -   | -                          |
| K3-210A..(=)   | x   | -   | -  | o   | o   | -   | -                          |
| K3-260A..(=)   | x   | -   | -  | o   | o   | -   | -                          |
| K3-316A..(=)   | x   | -   | -  | o   | o   | -   | -                          |
| K3-450A..(=)   | o   | -   | -  | o   | o   | -   | -                          |
| K3-550A..(=)   | o   | -   | -  | o   | o   | -   | -                          |
| K3-700A..(=)   | o   | -   | -  | o   | o   | -   | -                          |
| K3-860A..(=)   | o   | -   | -  | o   | o   | -   | -                          |
| K3-1000A..(=)  | -   | -   | -  | o   | o   | -   | -                          |
| K3-1200A..(=)  | o   | -   | -  | o   | o   | -   | -                          |
| <b>Contactor Relays, Contactors DC operated Series KG3</b>                                     |   |   |  |   |   |   |                            |
| KG3-07..   | o   | -   | -  | o   | o   | -   | o                          |
| KG3-10..., -14..   | o   | -   | -  | o   | o   | -   | o                          |
| KG3-18..., -22..   | o   | -   | -  | o   | o   | -   | o                          |
| KG3-24..., -32..   | o   | -   | -  | o   | o   | -   | o                          |
| KG3-40..   | o   | -   | -  | o   | o   | -   | o                          |
| <b>Capacitor Contactors Series K3</b>  |   |   |  |   |   |   |                            |
| K3-18K..   | o   | -   | -  | o   | o   | o   | o                          |
| K3-24K..   | o   | -   | -  | o   | o   | o   | o                          |
| K3-32K..   | o   | -   | -  | o   | o   | o   | o                          |
| K3-50K..   | o   | -   | -  | o   | o   | o   | o                          |
| K3-62K..   | o   | -   | -  | o   | o   | o   | o                          |
| K3-74K..   | o   | -   | -  | o   | o   | o   | o                          |
| K3-90K..   | o   | -   | -  | o   | o   | o   | -                          |
| K3-115K..  | o   | -   | -  | o   | o   | o   | -                          |
| <b>Aux. Contacts</b>   |   |   |  |   |   |   |                            |
| HN..., HTN..   | o   | -   | -  | o   | o   | o   | o                          |
| HA..   | o   | -   | -  | o   | o   | -   | o                          |
| HB..   | o   | -   | -  | o   | o   | o   | o                          |
| K2-DK, K2-SK   | o   | -   | -  | o   | o   | -   | -                          |
| HKA..., HKT..  | o   | -   | -  | o   | o   | -   | -                          |
| HKF22  | -   | -   | -  | o   | o   | -   | -                          |
| o approved in standard version      x pending      - not provided to be tested                 |   |   |  |   |   |   |                            |



# Approvals

| Country  | North America   |   | Switzerland  | Europe  | Russia<br>EAC   | China   | CENELEC<br>CB-Certificates |
|--|---|---|--|---|---|---|----------------------------|
| Typ  | UL<br> |  | SEV<br> |  |  |  |                            |
| <b>Accessories</b>   |   |   |  |   |   |   |                            |
| K2-T.E, -A   | -   | -   | -  | 0   | 0   | -   | -                          |
| K2-TP  | 0   | -   | -  | 0   | 0   | -   | -                          |
| K2-L   | 0   | -   | -  | 0   | 0   | -   | -                          |
| K2-IN.   | 0   | -   | -  | 0   | 0   | -   | -                          |
| K2-UN.   | 0   | -   | -  | 0   | 0   | -   | -                          |
| K2-IM  | -   | -   | -  | 0   | 0   | -   | -                          |
| K2-E   | 0   | -   | -  | 0   | 0   | -   | -                          |
| VG-K2  | -   | -   | -  | 0   | 0   | -   | -                          |
| RC-K3  | 0   | -   | -  | 0   | 0   | -   | -                          |
| <b>Reversing Contactors Series K3NWU</b>                   |   |   |  |   |   |   |                            |
| K3NWU-10   | 0   | -   | -  | 0   | 0   | -   | -                          |
| K3NWU-14   | 0   | -   | -  | 0   | 0   | -   | -                          |
| K3NWU-18   | 0   | -   | -  | 0   | 0   | -   | -                          |
| K3NWU-22   | 0   | -   | -  | 0   | 0   | -   | -                          |
| K3WU-24  | 0   | -   | -  | 0   | 0   | -   | -                          |
| K3WU-32  | 0   | -   | -  | 0   | 0   | -   | -                          |
| K3WU-40  | 0   | -   | -  | 0   | 0   | -   | -                          |
| <b>D.O.L Starters</b>                                      |   |   |  |   |   |   |                            |
| P1..   | 0   | -   | -  | 0   | 0   | -   | -                          |
| <b>Thermal Overload Relays</b>                             |   |   |  |   |   |   |                            |
| U3/32  | 0   | -   | -  | 0   | 0   | -   | 0                          |
| U3/42  | 0   | -   | -  | 0   | 0   | -   | 0                          |
| U3/74  | 0   | -   | -  | 0   | 0   | -   | 0                          |
| U12/16E  | 0   | -   | -  | 0   | 0   | -   | 0                          |
| U12/16A  | -   | -   | -  | 0   | 0   | -   | 0                          |
| U12/16EM   | -   | -   | -  | 0   | 0   | -   | 0                          |
| U12/16EQ   | -   | -   | -  | 0   | 0   | -   | 0                          |
| U32  | 0   | -   | -  | 0   | 0   | -   | 0                          |
| U60  | 0   | -   | -  | 0   | 0   | -   | 0                          |
| U85  | 0   | -   | -  | 0   | 0   | -   | 0                          |
| U180   | x   | -   | -  | 0   | 0   | -   | -                          |
| U320   | x   | -   | -  | 0   | 0   | -   | -                          |
| U800   | -   | -   | -  | 0   | 0   | -   | -                          |
| <b>Modular Contactors</b>                                  |   |   |  |   |   |   |                            |
| R20  | 0   | -   | 0  | 0   | 0   | -   | 0                          |
| R25  | 0   | -   | 0  | 0   | 0   | -   | 0                          |
| R40  | 0   | -   | 0  | 0   | 0   | -   | 0                          |
| R63  | 0   | -   | 0  | 0   | 0   | -   | 0                          |
| R40, R63 2-polig   | -   | -   | -  | 0   | 0   | -   | 0                          |
| RH11   | 0   | -   | -  | 0   | 0   | -   | 0                          |
| <b>Push Buttons</b>  |   |   |  |   |   |   |                            |
| B(C,K,S)3/4/5D   | 0   | -   | -  | 0   | 0   | -   | 0                          |
| <b>Contactors Relays and Contactors Series K3 (RAST 5)</b> |   |   |  |   |   |   |                            |
| K3-10/14/18/22NR   | 0   | -   | -  | 0   | 0   | 0   | 0                          |
| <b>Contactors for DC-Loads</b>                             |   |   |  |   |   |   |                            |
| K3DC-20 bis 80   | 0   | -   | -  | 0   | 0   | -   | 0                          |
| K3DC-100   | -   | -   | -  | 0   | 0   | -   | 0                          |
| K3PV-30 bis 60   | -   | -   | -  | 0   | 0   | -   | 0                          |
| K3PV-80  | 0   | -   | -  | 0   | 0   | -   | 0                          |
| K3PV-100   | -   | -   | -  | 0   | 0   | -   | 0                          |
| K3PV-150 bis 450   | 0   | -   | -  | 0   | 0   | -   | 0                          |
| <b>Main Contactors Series K3</b>                           |   |   |  |   |   |   |                            |
| K3-10/14/18/22NBD  | -   | -   | -  | 0   | 0   | -   | 0                          |

o approved in standard version

x pending

- not provided to be tested

# Approvals

| Country | North America   |   | Switzerland   | Europe  | Russia<br>EAC   | China   | CENELEC<br>CB-Certificates |
|---------|---|---|---|---|---|---|----------------------------|
| Typ     | UL  |   | SEV   | CE  | EAC   | CCC   |                            |
|         |  |  |  |  |  |  |                            |

## Motor Protection Circuit Breakers Series M4-..

|         |   |   |   |   |   |   |   |
|---------|---|---|---|---|---|---|---|
| M4-32T  | o | - | - | o | o | - | - |
| M4-32R  | o | - | - | o | o | - | - |
| M4-63R  | o | - | - | o | o | - | - |
| M4-100R | o | - | - | o | o | - | - |

## Zubehör

|       |   |   |   |   |   |   |   |
|-------|---|---|---|---|---|---|---|
| M4 HQ | o | - | - | o | o | - | - |
| M4 HS | o | - | - | o | o | - | - |
| M4 MA | o | - | - | o | o | - | - |
| M4 M  | o | - | - | o | o | - | - |
| M4 U  | o | - | - | o | o | - | - |
| M4 A  | o | - | - | o | o | - | - |

## Motor Protection Circuit Breakers Series MU25A-..

|       |   |   |   |   |   |   |   |
|-------|---|---|---|---|---|---|---|
| MU25A | o | - | - | o | - | - | - |
|-------|---|---|---|---|---|---|---|

## Accessories

|          |   |   |   |   |   |   |   |
|----------|---|---|---|---|---|---|---|
| MU25A-PS | o | - | - | o | - | - | - |
| MU25A-PV | o | - | - | o | - | - | - |
| MU25A-A  | o | - | - | o | - | - | - |
| MU25A-U  | o | - | - | o | - | - | - |

## Mini DC-Isolators

|          |   |   |   |   |   |   |   |
|----------|---|---|---|---|---|---|---|
| LSM16/25 | o | o | - | - | o | - | - |
|----------|---|---|---|---|---|---|---|

## DC-Switch Disconnectors, 2, 2+2, 4 pole

|               |   |   |   |   |   |   |   |
|---------------|---|---|---|---|---|---|---|
| LS16/20/25/32 | o | - | - | o | o | o | o |
| LS40/55       | o | - | - | o | o | o | o |

## DC-Switch Disconnectors, 3+2, 4+2, 6, 8 pole

|               |   |   |   |   |   |   |   |
|---------------|---|---|---|---|---|---|---|
| LS16/20/25/32 | o | o | - | o | o | o | - |
| LS40/55       | o | o | - | o | o | o | - |

## AC-Main Switches

|                |   |   |   |   |   |   |   |
|----------------|---|---|---|---|---|---|---|
| LTS20/25/32/40 | o | - | - | o | o | - | o |
| LTS63/80       | o | - | - | o | o | - | o |
| LTS85/100/125  | o | - | - | o | o | - | o |

## AC-Cam Switches

|         |   |   |   |   |   |   |   |
|---------|---|---|---|---|---|---|---|
| M4H     | o | - | - | o | o | - | o |
| M10     | o | - | - | o | o | - | o |
| M10H(D) | o | - | - | o | o | - | o |
| M20     | o | - | - | o | o | - | o |
| N33F    | o | - | - | o | o | - | o |
| N40     | o | - | - | o | o | - | o |
| N60     | o | - | - | o | o | - | o |
| N61     | o | - | - | o | o | - | o |
| N80     | o | - | - | o | o | - | o |
| N100    | o | - | - | o | o | - | o |
| N200    | o | - | - | o | o | - | o |
| L400    | o | - | - | o | o | - | o |

o approved in standard version

x pending

- not provided to be tested

**cUL<sup>us</sup> - and cRU<sup>us</sup> - Guide- and File-No.**

These data are important for UL-inspectors.  
Devices

| Devices  | Guide-No.         |      |                   |       | File-No. |
|--|-------------------|------|-------------------|-------|----------|
|  | cUL <sup>us</sup> |      | cRU <sup>us</sup> |       |          |
|  | Canada            | USA  | Canada            | USA   |          |
| Contactors                                       | NLDX7             | NLDX | NLDX8             | NLDX2 | E41502   |
| Revering Contactors                              | NLDX7             | NLDX | -                 | -     | E41502   |
| Contactors Relays, Accessories                   | NKCR7             | NKCR | NKCR8             | NKCR2 | E66273   |
| Thermal Overload Relays                          | NKCR7             | NKCR | -                 | -     | E66273   |
| Cam Switches                                     | NLRV7             | NLRV | -                 | -     | E129916  |
| Circuit Breakers as Manual Motor Controller      | NLRV7             | NLRV | -                 | -     | E129916  |
| Circuit Breakers as Combination Motor Controller | NKJH7             | NKJH | -                 | -     | E197641  |
| Bus Bar Assemblies                               | NLRV7             | NLRV | -                 | -     | E129916  |
| Accessories for Circuit Breakers                 | NKCR7             | NKCR | -                 | -     | E66273   |

## Technical Information

### Degree of protection acc. to IEC 60947-1

Protection ratings are prefixed by the internationally agreed letters IP followed by two digits.

1<sup>st</sup> digit: Pertains to solid objects  
2<sup>nd</sup> digit: Pertains to water.

| 1 <sup>st</sup> digit | Short description  | Definition   |
|-----------------------|--|--|
| 1                     | Protected against solid objects greater than 50 mm   | Excludes solid objects exceeding 50 mm in diameter and protects against contact with live and moving parts by a large body surface such as a hand (but not against deliberate access).   |
| 2L                    | Protected against solid objects greater than 12,5 mm and against contact by standard test finger | Excludes solid objects exceeding 12,5 mm in diameter and protects against contact with live and moving parts by a standard test finger or similar objects not exceeding 80 mm in length. |
| 3                     | Protected against solid objects  | Excludes solid objects exceeding 2,5 mm in diameter or thickness, greater than 2,5mm   |
| 4                     | Protected against solid objects greater than 1 mm  | Excludes solid objects exceeding 1 mm in diameter or thickness.  |
| 5                     | Dust protected   | Prevents ingress of dust in quantities and locations that would interfere with the intended operation of the equipment.  |
| 6                     | Dust tight   | Prevents ingress of dust.  |

### Terminal markings acc. to EN50011

Auxiliary contacts of AC contactors and contacts of contactor relays and thermal overload relays are particularly marked. The terminal markings of normally-open contacts are printed as positive figures, they of normally-closed contacts as negative figures.

This gives a clear indication of the function of the contacts.

The figure below illustrates the determination of terminal markings for contactors with auxiliary contact blocks.

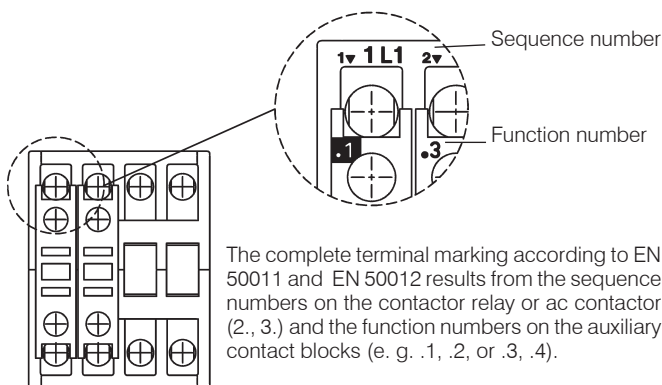

| 2 <sup>nd</sup> digit | Short description                                      | Definition   |
|-----------------------|--|--|
| 1                     | Protected against dripping water                       | Dripping water (vertically falling drops) shall have no harmful effect.  |
| 2                     | Protected against dripping water when tilted up to 15° | Vertically dripping water shall have no harmful effect when the enclosure is tilted at any angle up to 15° from its normal position.                 |
| 3                     | Protected against spraying water                       | Water falling as a spray at an angle up to 60° from the vertical shall have no harmful effect.   |
| 4                     | Protected against splashing water                      | Water splashed against the enclosure from any direction shall have no harmful effect.  |
| 5                     | Protected against water jets                           | Water protected by a nozzle against the enclosure from any direction shall have no harmful effect.   |
| 6                     | Protected against heavy seas                           | Water from heavy seas or water projected in powerful jets shall not enter the enclosure in harmful quantities.                                       |
| 7                     | Protected against the effects of immersion             | Ingress of water in a harmful quantity shall not be possible when the enclosure is immersed in water under standard conditions of pressure and time. |
| 8                     | Protected against submersion                           | No ingress of water.   |

### Resistance to climatic conditions acc. to IEC60068

Open-type devices are climate-resistant in the constant climate according to IEC60068-2-78 (this is a climate with an ambient temperature of 40°C and an atmospheric humidity of 90 to 95%).

Enclosed devices are climate-resistant in an alternating climate according to IEC 68-2-30 (this is a moist alternating climate with a 24-hour cycle between climates with an ambient temperature of 25°C, and an atmospheric humidity of 95 to 100% and an ambient temperature of 40°C, and an atmospheric humidity of 90 to 96% in the presence of condensation during rises in temperature).

Data are valid up to an altitude of 2000m above sea level.

### Short circuit protection

Back up fuses should be used to protect contactors and starters against short circuits. For starters the device with the smaller admissible fuse at the main and at the control circuit (contactor or thermal overload) determines the fuse size.

After a short circuit devices have to be checked for correct operation. Disconnect power before proceeding with any work on the equipment!

# Technical Information

## Mounting positions of contactors

K0-.. / K1-..

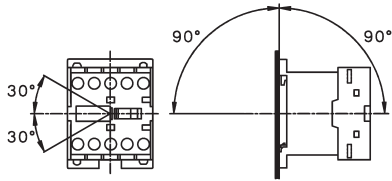

K2-..A00-40, K(G)3-07 to K3-115, R..

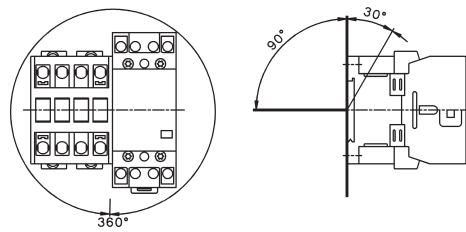



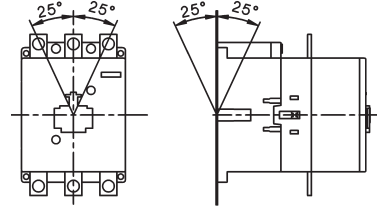



K3-151.. to K3-1200..



## Terminal screws

| Devices<br>Type   | Kind of connection    |                       |                                | Screw driver                           | Tightening torque                                |                                      |
|---|-----------------------|-----------------------|--------------------------------|--|--|--------------------------------------|
|   | Screw with washer     | Screw with clamp box  | Screw w. nut                   |  | Nm   | lb. inch                             |
| <b>Micro Contactors</b> , all conductors<br>K0-..   | M2,5                  | -                     | -                              | Pz1                                    | 0,6 - 0,8  | 5 - 7                                |
| <b>Mini Contactors</b> , all conductors<br>K1-..  | M3,5                  | -                     | -                              | Pz2                                    | 0,8 - 1,4  | 7 - 12                               |
| <b>Contactor Relays</b> , all conductors<br>K(G)3-07..  | M3,5                  | -                     | -                              | Pz2                                    | 0,8 - 1,4  | 7 - 12                               |
| <b>Contactors</b><br>Main conductor   |                       |                       |                                |  |  |                                      |
| K(G)3-10.. bis K3-22..  | M3,5                  | -                     | -                              | Pz2                                    | 0,8 - 1,4  | 7 - 12                               |
| K(G)3-24.. bis K3-40..  | -                     | M5                    | -                              | Pz2                                    | 2,5 - 3  | 22 - 26                              |
| K3-50.. bis K3-74..   | -                     | M6                    | -                              | Pz3                                    | 3,5 - 4,5  | 31 - 40                              |
| K2-23, -30, -37A00-40<br>K2-45, -60A00-40   | M4<br>-               | -<br>M6               | -<br>-                         | Pz2<br>Pz3                             | 1,2 - 1,8<br>3,5 - 4,5                           | 11 - 16<br>31 - 40                   |
| K3-90, K3-115   | -                     | -                     | M8                             | 4mm hex socket                         | 4 - 6,5  | 35 - 57                              |
| K3-116.. bis K3-176..<br>K3-210.. bis K3-316..<br>K3-450.. bis K3-700..<br>K3-860..<br>K3-1000.., K3-1200.. | -<br>-<br>-<br>-<br>- | -<br>-<br>-<br>-<br>- | M8<br>M10<br>M12<br>M14<br>M12 |  | 17<br>35<br>60<br>75<br>60                       | 150<br>315<br>540<br>675<br>540      |
| Auxiliary conductor<br>K(G)3-10 bis K3-22   | M3,5                  | -                     | -                              | Pz2                                    | 0,8 - 1,4  | 7 - 12                               |
| Coil conductor<br>K(G)3-10 bis K3-1200  | M3,5                  | -                     | -                              | Pz2                                    | 0,8 - 1,4  | 7 - 12                               |
| <b>Accessories</b><br>HK, HKM<br>HA, HN, K2-..., HB..   | M3,5<br>M3,5          | -<br>-                | -<br>-                         | Pz2<br>Pz2                             | 0,8 - 1,4<br>0,8 - 1,4                           | 7 - 12<br>7 - 12                     |
| <b>Thermal Overload Relays</b><br>Main conductor  |                       |                       |                                |  |  |                                      |
| U12/16  | M4                    | -                     | -                              | Pz2                                    | 1,2 - 1,8  | 11 - 16                              |
| U3/32<br>U3/42<br>U3/74   | M3,5<br>M5<br>-       | -<br>-<br>M6          | -<br>-<br>-                    | Pz2<br>Pz2<br>Pz3                      | 0,8 - 1,4<br>2,5 - 3<br>3,5 - 4,5                | 7 - 12<br>22 - 26<br>31 - 40         |
| UAT21<br>UAT22<br>UAT23   | -<br>-<br>-           | M4<br>M4<br>M5        | -<br>-<br>-                    | Size 3, 4<br>Size 3, 4<br>Size 3, 4, 5 | 1,2 - 1,8<br>1,2 - 1,8<br>2,5 - 3                | 11 - 16<br>11 - 16<br>22 - 26        |
| Auxiliary conductor<br>All devices  | M3,5                  | -                     | -                              | Pz2                                    | 0,8 - 1,4  | 7 - 12                               |
| <b>Contactors for Distribution Boards</b><br>Conductors   |                       |                       |                                |  |  |                                      |
| R20, R25<br>R40, R63<br>K1R   | -<br>-<br>M3,5        | M3,5<br>M5<br>-       | -<br>-<br>-                    | Pz1<br>Pz2<br>Pz2                      | 0,8 - 1,4<br>2,5 - 3<br>0,8 - 1,4                | 7 - 12<br>22 - 26<br>7 - 12          |
| Coil conductor<br>R20, R25<br>R40, R63<br>K1R<br>RH11   | -<br>-<br>M3,5<br>-   | M3<br>M3<br>-<br>M3   | -<br>-<br>-<br>-               | Pz1<br>Pz1<br>Pz2<br>Pz1               | 0,6 - 1,2<br>0,6 - 1,2<br>0,8 - 1,4<br>0,6 - 1,2 | 5 - 11<br>5 - 11<br>7 - 12<br>5 - 11 |



|   |   |                     |
|---|---|---------------------|
|    | <p>Micro Contactor Relays</p>                                 | <p>12</p>           |
|    | <p>Micro Contactors</p>                                       | <p>14</p>           |
|    | <p>Micro Contactors With Solder Pins</p> <p>Coil voltages</p> | <p>16</p> <p>16</p> |
|  | <p>Micro Reversing Contactor</p>                              | <p>18</p>           |
|  | <p>Technical Data</p>   | <p>20</p>           |
|  | <p>Dimensions</p>   | <p>24</p>           |

# Micro Contactor Relays 4-pole

AC Operated

**Ratings Therm.**      **Contacts 2)**      **Type**      **Coil voltage 1)**  
 Distinc.      Additional      **24**      24V 50/60Hz  
 Number      Contact      **230**      220-240V 50Hz/60Hz

**AC15**      Rated            **Blocks**  
**230V**      400V       $I_{th}$       A      NO      NC      acc. to      EN50011      Type      ↓      Pack      Weight  
**A**      A      A      NO      NC      EN50011      Type      pcs.      kg/pc.

## 4-pole, with Screw Terminals



| Type | 3 | 1,5 | 5 | 4 | - | 40E | - | K0-04D40 ... | 10 | 0,07 |
|------|---|-----|---|---|---|-----|---|--------------|----|------|
|      | 3 | 1,5 | 5 | 3 | 1 | 31E | - | K0-04D31 ... | 10 | 0,07 |
|      | 3 | 1,5 | 5 | 2 | 2 | 22E | - | K0-04D22 ... | 10 | 0,07 |

**K0-04D40**

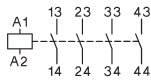

**K0-04D31**

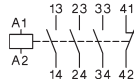

**K0-04D22**

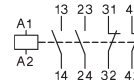

1) Other coil voltages on request.  
 2) Contacts suitable for electronic circuits, according to EN947-5-4 for rated voltage 24V DC (test ratings 17V DC, 5mA). Mirror contacts acc. IEC60947-4-1 Annex F.

# Micro Contactor Relays 4-pole

DC Operated

| Ratings Therm.                      | Contacts <sup>2)</sup> | Distinc. Number | Additional Contact | Type            | Coil voltage <sup>1)</sup> | Pack pcs.            | Weight kg/pc. |
|-------------------------------------|------------------------|-----------------|--------------------|-----------------|----------------------------|----------------------|---------------|
| <b>AC15</b>                         | Rated Current          |                 |                    |                 | <b>= 24</b>                |                      |               |
| <b>230V A</b>                       | 400V A                 | $I_{th}$ A      | NO NC              | acc. to EN50011 | 24V=DC                     |                      |               |
| <b>4-pole, with Screw Terminals</b> |                        |                 |                    |                 |                            |                      |               |
| <b>3</b>                            | 1,5                    | 5               | 4 -                | 40E             | -                          | <b>K0-04D40= ...</b> | 10 0,09       |
| <b>3</b>                            | 1,5                    | 5               | 3 1                | 31E             | -                          | <b>K0-04D31= ...</b> | 10 0,09       |
| <b>3</b>                            | 1,5                    | 5               | 2 2                | 22E             | -                          | <b>K0-04D22= ...</b> | 10 0,09       |



**K0-04D40**

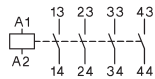

**K0-04D31**

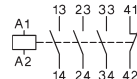

**K0-04D22**

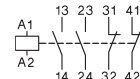

1) Other coil voltages on request.  
 2) Contacts suitable for electronic circuits, according to EN947-5-4 for rated voltage 24V DC (test ratings 17V DC, 5mA). Mirror contacts acc. IEC60947-4-1 Annex F.

# Micro Contactors

AC Operated



| Power Ratings  | Rated Current     | Aux. Contacts <sup>2)</sup> |            | Type                    | Coil voltage <sup>1)</sup>        | Pack pcs. | Weight kg/pc. |
|--|-------------------|-----------------------------|------------|-------------------------|-----------------------------------|-----------|---------------|
|  |                   | Built-in                    | Additional |                         |                                   |           |               |
| AC2, AC3<br><b>380V</b><br><b>400V</b><br><b>415V</b><br><b>kW</b> | 660V<br>690V<br>A | AC1                         | NO NC      | <b>24</b><br><b>230</b> | 24V 50/60Hz<br>220-240V 50Hz/60Hz |           |               |
|  |                   |                             |            | ↓                       |                                   |           |               |

### 3-pole, with Screw Terminals

|     |   |    |   |   |   |                     |    |      |
|-----|---|----|---|---|---|---------------------|----|------|
| 2,2 | - | 12 | 1 | - | - | <b>K0-05D10 ...</b> | 10 | 0,07 |
|-----|---|----|---|---|---|---------------------|----|------|

|     |   |    |   |   |   |                     |    |      |
|-----|---|----|---|---|---|---------------------|----|------|
| 2,2 | - | 12 | - | 1 | - | <b>K0-05D01 ...</b> | 10 | 0,07 |
|-----|---|----|---|---|---|---------------------|----|------|

### 4-pole, With Screw Terminals

|     |   |    |   |   |   |                        |    |      |
|-----|---|----|---|---|---|------------------------|----|------|
| 2,2 | - | 12 | - | - | - | <b>K0-05D00-40 ...</b> | 10 | 0,07 |
|-----|---|----|---|---|---|------------------------|----|------|

**K0-05D10**

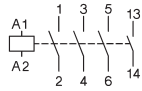

**K0-05D01**

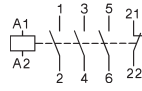

**K0-05D00-40**

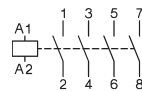

1) Other coil voltages see page 14.

2) Contacts suitable for electronic circuits, according to EN947-5-4 for rated voltage 24V DC (test ratings 17V DC, 5mA). Mirror contacts acc. IEC60947-4-1 Annex F.

# Micro Contactors

DC Operated



| Power Ratings | Rated Current | Aux. Contacts <sup>2)</sup> |            | Type        | Coil voltage <sup>1)</sup><br>= 24 24V= DC | Pack pcs. | Weight kg/pc. |
|---------------|---------------|-----------------------------|------------|-------------|--|-----------|---------------|
|               |               | Built-in                    | Additional |             |  |           |               |
| AC2, AC3      | AC1           |                             |            |             |  |           |               |
| <b>380V</b>   |               |                             |            |             |  |           |               |
| <b>400V</b>   | 660V          |                             |            |             |  |           |               |
| <b>415V</b>   | 690V          | 440V                        |            |             |  |           |               |
| <b>kW</b>     | <b>kW</b>     | <b>A</b>                    | NO NC      | Blocks Type |  |           |               |

## 3-pole, with Screw Terminals

|     |   |    |   |   |   |                      |    |      |
|-----|---|----|---|---|---|----------------------|----|------|
| 2,2 | - | 12 | 1 | - | - | <b>K0-05D10= ...</b> | 10 | 0,09 |
|-----|---|----|---|---|---|----------------------|----|------|

|     |   |    |   |   |   |                      |    |      |
|-----|---|----|---|---|---|----------------------|----|------|
| 2,2 | - | 12 | - | 1 | - | <b>K0-05D01= ...</b> | 10 | 0,09 |
|-----|---|----|---|---|---|----------------------|----|------|

## 4-pole, With Screw Terminals

|     |   |    |   |   |   |                         |    |      |
|-----|---|----|---|---|---|-------------------------|----|------|
| 2,2 | - | 12 | - | - | - | <b>K0-05D00-40= ...</b> | 10 | 0,09 |
|-----|---|----|---|---|---|-------------------------|----|------|

**K0-05D10**

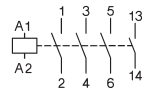

**K0-05D01**

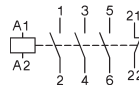

**K0-05D00-40**

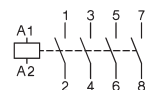

# Snap-On Adapter

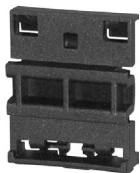

| For Type | Specification          | Type  | Pack pcs.. | Weight kg/pc. |
|----------|------------------------|-------|------------|---------------|
| K0       | Snap on Adapter for K0 | P1039 | 10         | 0,0061        |

for snap-on mounting of contactor K0 on 35mm DIN-rail acc. DIN EN 50022

1) Other coil voltages see page 14.

2) Contacts suitable for electronic circuits, according to EN947-5-4 for rated voltage 24V DC (test ratings 17V DC, 5mA). Mirror contacts acc. IEC60947-4-1 Annex F.

Contactor, Motor-Starters  
Circuit Breakers  
Manual Motor-Starters  
Switches  
AC-Main Switches  
DC-Switch Disconnectors  
Push Buttons  
Representatives, Suppliers



# Micro Contactors

# AC Operated

| Power Ratings | Rated Current | Aux. Contacts <sup>2)</sup> |            | Type | Coil voltage <sup>1)</sup> | Pack pcs. | Weight kg/pc. |
|---------------|---------------|-----------------------------|------------|------|----------------------------|-----------|---------------|
|               |               | Built in                    | Additional |      |                            |           |               |
| AC2, AC3      | AC1           |                             |            |      | 24V 50/60Hz                |           |               |
| <b>380V</b>   |               |                             |            |      | 220-240V 50Hz/60Hz         |           |               |
| <b>400V</b>   | 660V          |                             |            |      |                            |           |               |
| <b>415V</b>   | 690V          | 440V                        |            |      |                            |           |               |
| <b>kW</b>     | <b>kW</b>     | <b>A</b>                    | NO NC      | Type |                            |           |               |



### 3-pole, with Solder Pins Ø1,15 for Printed Circuit Applications

|     |   |   |   |   |   |                     |    |      |
|-----|---|---|---|---|---|---------------------|----|------|
| 2,2 | - | 9 | 1 | - | - | <b>K0-05L10</b> ... | 10 | 0,07 |
|-----|---|---|---|---|---|---------------------|----|------|

|     |   |   |   |   |   |                     |    |      |
|-----|---|---|---|---|---|---------------------|----|------|
| 2,2 | - | 9 | - | 1 | - | <b>K0-05L01</b> ... | 10 | 0,07 |
|-----|---|---|---|---|---|---------------------|----|------|

### 4-pole, with Solder Pins Ø1,15 for Printed Circuit Applications

|     |   |   |   |   |   |                        |    |      |
|-----|---|---|---|---|---|------------------------|----|------|
| 2,2 | - | 9 | - | - | - | <b>K0-05L00-40</b> ... | 10 | 0,07 |
|-----|---|---|---|---|---|------------------------|----|------|

**K0-05L10**

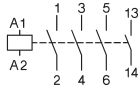

**K0-05L01**

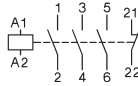

**K0-05L00-40**

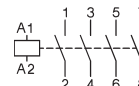

## Coil voltages for AC operated contactors

| Suffix to contactor type<br>e.g. K0-05D10 24 | Voltage Marking at the coil for |           | Rated Control Voltage U <sub>s</sub> range for 50Hz for 60Hz |           |           |           |
|--|---------------------------------|-----------|--|-----------|-----------|-----------|
|  | 50Hz                            | 60Hz      | min.   | max.      | min.      | max.      |
| 12   | 12                              | 12        | 11   | 12        | 12        | 12        |
| <b>24</b>                                    | <b>24</b>                       | <b>24</b> | <b>22</b>  | <b>24</b> | <b>24</b> | <b>24</b> |
| 42   | 42                              | 42        | 38,5   | 42        | 42        | 42        |
| 48   | 48                              | 48        | 48   | 50        | 48        | 52        |
| 90   | 100                             | 100       | 90   | 100       | 100       | 105       |
| 95   | 95-100                          | 105-110   | 95   | 100       | 105       | 110       |
| 100  | 100                             | 110-115   | 100  | 105       | 110       | 115       |
| 105  | 105-110                         | 115-120   | 105  | 110       | 115       | 120       |
| 110  | 110-115                         | 120-125   | 110  | 115       | 120       | 125       |
| 180  | 200                             | 200       | 185  | 200       | 200       | 210       |

| Suffix to contactor type<br>e.g. K0-05D10 230 | Voltage Marking at the coil for |                | Rated Control Voltage U <sub>s</sub> range for 50Hz for 60Hz |            |            |            |
|---|---------------------------------|----------------|--|------------|------------|------------|
|   | 50Hz                            | 60Hz           | min.   | max.       | min.       | max.       |
| 200   | 200                             | 200-220        | 195  | 205        | 200        | 220        |
| 210   | 205-215                         | 220-230        | 205  | 215        | 220        | 230        |
| 220   | 210-220                         | 220-240        | 210  | 220        | 220        | 240        |
| <b>230</b>                                    | <b>220-230</b>                  | <b>230-250</b> | <b>220</b>   | <b>230</b> | <b>230</b> | <b>250</b> |
| 240   | 230-240                         |                | 230  | 240        | 250        | 260        |

**Standard voltages in bold type letters**  
**Operating range of magnet-coils: 0,85 x U<sub>s</sub>**  
**(min. value of rated control voltage)**  
**up to 1,1 x U<sub>s</sub>**  
**(max. value of rated control voltage)**

Coil not exchangeable

1) Other coil voltages see page 14.

2) Contacts suitable for electronic circuits, according to EN947-5-4 for rated voltage 24V DC (test ratings 17V DC, 5mA). Mirror contacts acc. IEC60947-4-1 Annex F.

# Micro Contactors

DC Operated

| Power Ratings  | Rated Current      | Aux. Contacts <sup>2)</sup> |            | Type | Coil voltage <sup>1)</sup><br>= 24 24V= DC | Pack pcs. | Weight kg/pc. |
|--|--------------------|-----------------------------|------------|------|--|-----------|---------------|
|  |                    | Built in                    | Additional |      |  |           |               |
| AC2, AC3<br><b>380V</b><br><b>400V</b><br><b>415V</b><br><b>kW</b> | 660V<br>690V<br>kW | AC1<br>440V<br>A            |            |      |  |           |               |
|  |                    |                             | NO NC      | Type | ↓  |           |               |



### 3-pole, with Solder Pins Ø1,15 for Printed Circuit Applications

|     |   |   |   |   |   |                     |    |      |
|-----|---|---|---|---|---|---------------------|----|------|
| 2,2 | - | 9 | 1 | - | - | <b>K0-05L10 ...</b> | 10 | 0,07 |
|-----|---|---|---|---|---|---------------------|----|------|

|     |   |   |   |   |   |                     |    |      |
|-----|---|---|---|---|---|---------------------|----|------|
| 2,2 | - | 9 | - | 1 | - | <b>K0-05L01 ...</b> | 10 | 0,07 |
|-----|---|---|---|---|---|---------------------|----|------|

### 4-pole, with Solder Pins Ø1,15 for Printed Circuit Applications

|     |   |   |   |   |   |                        |    |      |
|-----|---|---|---|---|---|------------------------|----|------|
| 2,2 | - | 9 | - | - | - | <b>K0-05L00-40 ...</b> | 10 | 0,07 |
|-----|---|---|---|---|---|------------------------|----|------|

**K0-05L10**

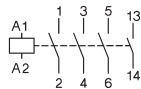

**K0-05L01**

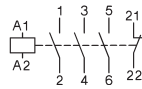

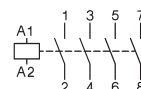

**K0-05L00-40**



1) Other coil voltages see page 14.  
 2) Contacts suitable for electronic circuits, according to EN947-5-4 for rated voltage 24V DC (test ratings 17V DC, 5mA). Mirror contacts acc. IEC60947-4-1 Annex F.

# Micro Reversing Contactors, Mechanical Interlocked

AC Operated

| Power Ratings | Rated Current | Aux. Contacts <sup>2)</sup> |   | Type    | Coil voltage <sup>1)</sup><br>24V 50/60Hz<br>220-240V 50Hz/60Hz | Pack pcs. | Weight kg/pc. |
|---------------|---------------|-----------------------------|---|---------|---|-----------|---------------|
|               |               | Built-in                    | Additional on left hand side Contactor  |         |   |           |               |
| AC2, AC3      | AC1           |                             |   |         |   |           |               |
| <b>380V</b>   |               |                             |   |         |   |           |               |
| <b>400V</b>   | 660V          |                             |   |         |   |           |               |
| <b>415V</b>   | 690V          | 440V                        |  | K1 Type |   |           |               |
| <b>kW</b>     | <b>kW</b>     | <b>A</b>                    |  | K2 Type |   |           |               |

## 3-pole, with Screw Terminals



|     |   |    |   |   |   |   |                       |   |      |
|-----|---|----|---|---|---|---|-----------------------|---|------|
| 2,2 | - | 12 | - | 2 | - | - | <b>K0W05D01MC ...</b> | 1 | 0,14 |
|-----|---|----|---|---|---|---|-----------------------|---|------|

|     |   |    |   |   |   |   |                       |   |      |
|-----|---|----|---|---|---|---|-----------------------|---|------|
| 2,2 | - | 12 | 2 | - | - | - | <b>K0W05D10MC ...</b> | 1 | 0,14 |
|-----|---|----|---|---|---|---|-----------------------|---|------|

## 4-pole, with Screw Terminals



|     |   |    |   |   |   |   |                          |   |      |
|-----|---|----|---|---|---|---|--------------------------|---|------|
| 2,2 | - | 12 | - | - | - | - | <b>K0W05D00-40MC ...</b> | 1 | 0,14 |
|-----|---|----|---|---|---|---|--------------------------|---|------|

## 3-pole, with Solder Pins Ø1,15 for Printed Circuit Applications

|     |   |                   |   |   |   |   |                       |   |      |
|-----|---|-------------------|---|---|---|---|-----------------------|---|------|
| 2,2 | - | xxx <sup>3)</sup> | - | 2 | - | - | <b>K0W05L01MC ...</b> | 1 | 0,14 |
|-----|---|-------------------|---|---|---|---|-----------------------|---|------|

|     |   |                   |   |   |   |   |                       |   |      |
|-----|---|-------------------|---|---|---|---|-----------------------|---|------|
| 2,2 | - | xxx <sup>3)</sup> | 2 | - | - | - | <b>K0W05L10MC ...</b> | 1 | 0,14 |
|-----|---|-------------------|---|---|---|---|-----------------------|---|------|

**K0W05D01MC**

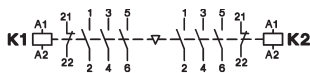

**K0W05D10MC**

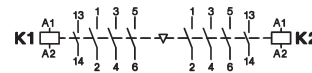

**K0W05D00-40MC**

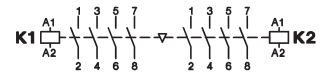

# Reversing Starter Connector



For Reversing Starter Types, incl. Coil Connector

|                   |               |   |      |
|-------------------|---------------|---|------|
| <b>K0W05D..MC</b> | <b>K0W-VB</b> | 1 | 0,01 |
|-------------------|---------------|---|------|

1) Other coil voltages see page 14.

2) Contacts suitable for electronic circuits, according to EN947-5-4 for rated voltage 24V DC (test ratings 17V DC, 5mA). Mirror contacts acc. IEC60947-4-1 Annex F.

3) Data on request.

# Micro Reversing Contactors, Mechanical Interlocked

DC Operated

| Power Ratings | Rated Current | Aux. Contacts <sup>2)</sup> |                             | Type                         | Coil voltage <sup>1)</sup><br>= 24 24V= DC | Pack pcs. | Weight kg/pc. |
|---------------|---------------|-----------------------------|-----------------------------|------------------------------|--|-----------|---------------|
|               |               | Built-in                    | Additional                  |                              |  |           |               |
| AC2, AC3      | AC1           |                             | on left hand side Contactor | on right hand side Contactor |  |           |               |
| <b>380V</b>   |               |                             |                             |                              |  |           |               |
| <b>400V</b>   | 660V          |                             |                             |                              |  |           |               |
| <b>415V</b>   | 690V          | 440V                        |                             |                              |  |           |               |
| <b>kW</b>     | <b>kW</b>     | <b>A</b>                    | NO NC                       | K1 Type                      |  |           |               |

## 3-pole, with Screw Terminals



|     |   |    |   |   |   |   |                       |   |      |
|-----|---|----|---|---|---|---|-----------------------|---|------|
| 2,2 | - | 12 | - | 2 | - | - | <b>K0W05D01MC ...</b> | 1 | 0,14 |
|-----|---|----|---|---|---|---|-----------------------|---|------|

|     |   |    |   |   |   |   |                       |   |      |
|-----|---|----|---|---|---|---|-----------------------|---|------|
| 2,2 | - | 12 | 2 | - | - | - | <b>K0W05D10MC ...</b> | 1 | 0,14 |
|-----|---|----|---|---|---|---|-----------------------|---|------|

## 4-pole, with Screw Terminals



|     |   |    |   |   |   |   |                          |   |      |
|-----|---|----|---|---|---|---|--------------------------|---|------|
| 2,2 | - | 12 | - | - | - | - | <b>K0W05D00-40MC ...</b> | 1 | 0,14 |
|-----|---|----|---|---|---|---|--------------------------|---|------|

## 3-pole, with Solder Pins Ø1,15 for Printed Circuit Applications

|     |   |                   |   |   |   |   |                       |   |      |
|-----|---|-------------------|---|---|---|---|-----------------------|---|------|
| 2,2 | - | xxx <sup>3)</sup> | - | 2 | - | - | <b>K0W05L01MC ...</b> | 1 | 0,14 |
|-----|---|-------------------|---|---|---|---|-----------------------|---|------|

|     |   |                   |   |   |   |   |                       |   |      |
|-----|---|-------------------|---|---|---|---|-----------------------|---|------|
| 2,2 | - | xxx <sup>3)</sup> | 2 | - | - | - | <b>K0W05L10MC ...</b> | 1 | 0,14 |
|-----|---|-------------------|---|---|---|---|-----------------------|---|------|

**K0W05D01MC**

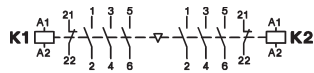

**K0W05D10MC**

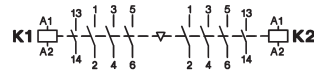

**K0W05D00-40MC**



1) Other coil voltages see page 14.  
 2) Contacts suitable for electronic circuits, according to EN947-5-4 for rated voltage 24V DC (test ratings 17V DC, 5mA). Mirror contacts acc. IEC60947-4-1 Annex F.  
 3) Data on request.

# Micro Contactors

## Data according to IEC 60947-4-1, VDE 0660, EN 60947-4-1

| Main Contacts   | Type  | K0-05D..   | K0-05L..                        |
|---|---|--|---------------------------------|
| <b>Rated insulation voltage <math>U_i</math></b>                                  | V AC  | 440 <sup>1)</sup>  | 440 <sup>1)</sup>               |
| <b>Making capacity <math>I_{eff}</math></b><br>at $U_e = 440V$ AC                 | A   | 65   | 65                              |
| <b>Breaking capacity <math>I_{eff}</math></b><br>$\cos\phi = 0,65$                | 400V AC<br>A  | 50   | 50                              |
| <b>Utilization category AC1</b>   |   |  |                                 |
| <b>Switching of resistive load</b>  |   |  |                                 |
| Rated operational current $I_e (=I_{th})$ at 40°C, open                           | <b>A</b>  | <b>12</b>  | <b>9</b>                        |
| Rated operational power of three-phase resistive loads<br>50-60Hz, $\cos\phi = 1$ | 230V kW<br>240V kW<br>400V kW<br>415V kW<br>440V kW | 4,7<br>4,8<br>8,3<br>8,6<br>9,0  | 3,5<br>3,7<br>3,3<br>6,4<br>6,8 |
| Rated operational current $I_e (=I_{th})$ at 60°C, enclosed                       | A   | 8  | 6                               |
| Rated operational power of three-phase resistive loads<br>50-60Hz, $\cos\phi = 1$ | 230V kW<br>240V kW<br>400V kW<br>415V kW<br>440V kW | 3,1<br>3,3<br>5,5<br>5,7<br>6,0  | 2,3<br>2,4<br>4,1<br>4,3<br>4,5 |
| Minimum cross-section of conductor at load with $I_e (=I_{th})$                   | mm <sup>2</sup>                                     | 1,5  | -                               |
| <b>Utilization category AC2 and AC3</b>   |   |  |                                 |
| <b>Switching of three-phase motors</b>  |   |  |                                 |
| Rated operational current $I_e$<br>open and enclosed                              | 220V A<br>230V A<br>240V A                          | 6,2<br>6,2<br>5,6  | 6,2<br>6,2<br>5,6               |
|   | <b>380-400V A</b><br>415-440V A                     | <b>5</b><br>5  | <b>5</b><br>5                   |
| Rated operational power of three-phase motors<br>50-60Hz                          | 220-240V kW<br><b>380-440V kW</b>                   | 1,5<br><b>2,2</b>  | 1,5<br>2,2                      |
| <b>Utilization category AC4</b>   |   |  |                                 |
| <b>Switching of squirrel cage motors, inching</b>                                 |   |  |                                 |
| Rated operational current $I_e$<br>open and enclosed                              | 220V A<br>230V A<br>240V A                          | 4,9<br>4,9<br>4,1  | 4,9<br>4,9<br>4,1               |
|   | <b>380-400V A</b><br>415-440V A                     | <b>3,5</b><br>3,5  | <b>3,5</b><br>3,5               |
| Rated operational power of three-phase motors<br>50-60Hz                          | 220-240V kW<br><b>380-440V kW</b>                   | 1,1<br><b>1,5</b>  | 1,1<br>1,5                      |
| <b>Utilization category AC5a</b>  |   |  |                                 |
| <b>Switching of gas discharge lamps</b>   |   |  |                                 |
| Rated operational current $I_e$<br>per pole at 220/230V                           |   |  |                                 |
| Fluorescent lamps,<br>uncompensated and serial compensated                        | A   | 6  | 6                               |
| parallel compensated  | A   | 0,5  | 0,5                             |
| dual-connection   | A   | 9  | 9                               |
| Metal halide lamps <sup>2)</sup> ,<br>uncompensated                               | A   | 6  | 6                               |
| parallel compensated  | A   | 0,5  | 0,5                             |
| Mercury-vapour lamps <sup>3)</sup> ,<br>uncompensated                             | A   | 9  | 9                               |
| parallel compensated  | A   | 0,5  | 0,5                             |
| Mixed light lamps <sup>4)</sup>   | A   | 9  | 9                               |
| <b>LED-Lamps</b>  |   |  |                                 |
| consider the inrush current of the lamp ballast<br>and $\cos\phi$ of the lamp     | max. lamps per pole ( $I_{nLED} \leq I_{th}$ ) =    | $\frac{\text{inrush current of contactor}}{\text{inrush current of lamp/EVG}}$ |                                 |
| max inrush current of contactor   | A   | 91   | 91                              |
| <b>Utilization category AC5b</b>  |   |  |                                 |
| <b>Switching of incandescent lamps<sup>5)</sup></b>                               |   |  |                                 |
| Rated operational current $I_e$<br>per pole at 220/230V                           | A   | 3  | 3                               |

1) Suitable for: earthed-neutral systems, overvoltage category I to III, pollution degree 3 (standard-industry):  $U_{imp} = 4kV$ .  
Data for other conditions on request.

2) Metal halide lamps and sodium-vapour lamps (high- and low-pressure lamps)

3) High-pressure lamps

4) Blended lamps, containing a mercury high-pressure unit and a tungsten helix in a fluorescent glass bulb (daylight lamps)

5) Current inrush approx. 16 x  $I_e$



# Micro Contactors

## Data according to IEC 60947-4-1, VDE 0660, EN 60947-4-1

| Main Contacts   | Type  | K0-05D..                       | K0-05L..         |
|---|---|--------------------------------|------------------|
| <b>Utilization category DC1</b>   |   |                                |                  |
| <b>Switching of resistive load</b>  | 1 pole 24V A                                      | 12                             | 9                |
| Time constant L/R ≤1ms  | 60V A   | 12                             | 9                |
| Rated operational current I <sub>e</sub>  | 110V A  | 2                              | 2                |
|   | 180V A  | 0,6                            | 0,6              |
|   | 220V A  | 0,4                            | 0,4              |
|   | 3 poles in series 24V A                           | 12                             | 9                |
|   | 60V A   | 12                             | 9                |
|   | 110V A  | 12                             | 9                |
|   | 180V A  | 12                             | 9                |
|   | 220V A  | 8                              | 8                |
| <b>Utilization category DC3 and DC5</b>   |   |                                |                  |
| <b>Switching of shunt motors and series motors</b>  | 1 pole 24V A                                      | 12                             | 9                |
| Time constant L/R ≤15ms   | 60V A   | 4                              | 4                |
| Rated operational current I <sub>e</sub>  | 110V A  | 1                              | 1                |
|   | 180V A  | 0,5                            | 0,5              |
|   | 220V A  | 0,3                            | 0,3              |
|   | 3 Pole in Serie 24V A                             | 12                             | 9                |
|   | 60V A   | 12                             | 9                |
|   | 110V A  | 6                              | 6                |
|   | 180V A  | 4                              | 4                |
|   | 220V A  | 1                              | 1                |
| <b>Maximum ambient temperature</b>  |   |                                |                  |
| Operation   | open °C   | -40 to +60 (+90) <sup>1)</sup> |                  |
|   | enclosed °C                                       | -40 to +40                     |                  |
|   | with thermal overload relay open °C               | -25 to +60                     |                  |
|   | enclosed °C                                       | -25 to +40                     |                  |
| Storage   | °C  | -50 to +90                     |                  |
| <b>Short circuit protection</b>   |   |                                |                  |
| for contactors without thermal overload relay   |   |                                |                  |
| Coordination-type "1" according to IEC 947-4-1  |   |                                |                  |
| Contact welding without hazard of persons max. fuse size  | gL (gG) A   | 32                             | 32               |
| Coordination-type "2" according to IEC 947-4-1  |   |                                |                  |
| Light contact welding accepted max. fuse size   | gL (gG) A   | -                              | -                |
| Contact welding not accepted max. fuse size   | gL (gG) A   | -                              | -                |
| For contactors with thermal overload relay the device with the smaller admissible backup fuse (contactor or thermal overload relay) determines the fuse size. |   |                                |                  |
| <b>Cable cross-sections</b>   |   |                                |                  |
| for contactors  |   |                                |                  |
| main connector  | solid or stranded mm <sup>2</sup>                 | 0,5 - 1,5                      | Solder Connector |
|   | flexible mm <sup>2</sup>                          | 0,5 - 1,5                      | Ø 1,15           |
| Cables per clamp  | flexible with multicore cable end mm <sup>2</sup> | 0,5 - 1,5                      | -                |
|   | solid or stranded AWG                             | 2                              | -                |
|   |   | 20 - 14                        | -                |
| <b>Frequency of operation z</b>   |   |                                |                  |
| contactors without thermal overload relay   | without load 1/h                                  | 10000                          | 10000            |
|   | AC3, I <sub>e</sub> 1/h                           | 600                            | 600              |
|   | AC4, I <sub>e</sub> 1/h                           | 120                            | 120              |
|   | DC3, I <sub>e</sub> 1/h                           | 600                            | 600              |
| <b>Mechanical life</b>  |   |                                |                  |
|   | AC operated S x10 <sup>6</sup>                    | 3                              | 3                |
|   | DC operated S x10 <sup>6</sup>                    | 4                              | 4                |
| <b>Short time current</b>   |   |                                |                  |
|   | 10s-current A                                     | 50                             | 50               |
| <b>Power loss per pole</b>  |   |                                |                  |
|   | at I <sub>e</sub> /AC3 400V W                     | 0,2                            | 0,2              |
| <b>Resistance to shock according to IEC 68-2-27</b>   |   |                                |                  |
| Shock time 20ms sine-wave   |   |                                |                  |
| AC operated   | NO g  | 2,5                            | 2,5              |
|   | NC g  | 2,5                            | 2,5              |

1) With reduced control voltage range 0,9 up to 1,0 x U<sub>s</sub> and with reduced rated current I<sub>e</sub>/AC1 according to I<sub>e</sub>/AC3.

# Micro Contactors

## Data according to IEC 60947-5-1, VDE 0660, EN 60947-5-1

| Auxiliary Contacts   |                                   |                 | Type      | K0-04D..<br>K0-05D..           | K0-04L..<br>K0-05L.. |
|--|-----------------------------------|-----------------|-----------|--------------------------------|----------------------|
| <b>Rated insulation voltage</b>  | <b>U<sub>i</sub></b>              | VAC             |           | 440 <sup>1)</sup>              | 440 <sup>1)</sup>    |
| <b>Thermal rated current I<sub>th</sub></b> to 440V  |                                   |                 |           |                                |                      |
| Ambient temperature  | 40°C                              | A               |           | 5                              | 5                    |
|  | 60°C                              | A               |           | 3                              | 3                    |
| <b>Verlustleistung</b> pro Pol   | bei I <sub>th</sub>               | W               |           | 0,25                           | 0,25                 |
| <b>Utilization category AC15</b>   |                                   |                 |           |                                |                      |
| Rated operational current I <sub>e</sub>   | 220-240V                          | A               |           | 3                              | 3                    |
|  | 380-415V                          | A               |           | 1,5                            | 1,5                  |
|  | 440V                              | A               |           | 1                              | 1                    |
| <b>Utilization category DC13</b>   |                                   |                 |           |                                |                      |
| Rated operational current I <sub>e</sub>   | 24V                               | A               |           | 2                              | 2                    |
|  | 60V                               | A               |           | 1,6                            | 1,6                  |
|  | 110V                              | A               |           | 0,3                            | 0,3                  |
|  | 180V                              | A               |           | 0,2                            | 0,2                  |
|  | 220V                              | A               |           | 0,05                           | 0,05                 |
| <b>Maximum ambient temperature</b>   |                                   |                 |           |                                |                      |
| Operation  | open                              | °C              |           | -40 to +60 (+90) <sup>2)</sup> |                      |
|  | enclosed                          | °C              |           | -40 to +40                     |                      |
| Storage  |                                   | °C              |           | -40 to +90                     |                      |
| <b>Short circuit protection</b>  |                                   |                 |           |                                |                      |
| short-circuit current 1kA,<br>contact welding not accepted<br>max. fuse size   |                                   |                 | gL (gG) A | 10                             | 10                   |
| For contactors with thermal overload relay the device with the smaller admissible control fuse (contactor or thermal overload relay) determines the fuse size. |                                   |                 |           |                                |                      |
| <b>Power consumption of coils</b>  |                                   |                 |           |                                |                      |
| AC operated  | inrush                            | VA              |           | 9                              | 9                    |
|  | sealed                            | VA              |           | 4                              | 4                    |
|  |                                   | W               |           | 1,8                            | 1,8                  |
| DC operated  | inrush                            | W               |           | 2,5                            | 2,5                  |
|  | sealed                            | W               |           | 2,5                            | 2,5                  |
| <b>Operation range of coils</b>  |                                   |                 |           |                                |                      |
| in multiples of control voltage U <sub>s</sub>   |                                   | AC              |           | 0,85 - 1,1                     | 0,85 - 1,1           |
|  |                                   | DC              |           | 0,8 - 1,1                      | 0,8 - 1,1            |
| <b>Switching time</b> at control voltage U <sub>s</sub> ±10% <sup>3) 4)</sup>  |                                   |                 |           |                                |                      |
| AC operated  | make time                         | ms              |           | 13 - 18                        | 13 - 18              |
|  | release time                      | ms              |           | 5 - 10                         | 5 - 10               |
|  | arc duration                      | ms              |           | 10 - 15                        | 10 - 15              |
| DC operated  | make time                         | ms              |           | 10 - 40                        | 10 - 40              |
|  | release time                      | ms              |           | 2 - 10                         | 2 - 10               |
|  | arc duration                      | ms              |           | 10 - 15                        | 10 - 15              |
| <b>Cablecross-section</b>  |                                   |                 |           |                                |                      |
| all connectors   | solid                             | mm <sup>2</sup> |           | 0,5 - 1,5                      | Solder Connector     |
|  | flexible                          | mm <sup>2</sup> |           | 0,5 - 1,5                      | Ø 1,15               |
|  | flexible with multicore cable end | mm <sup>2</sup> |           | 0,5 - 1,5                      |                      |
| Clamps per pole  |                                   |                 |           | 2                              | -                    |
|  | solid or stranded                 | AWG             |           | 20 - 14                        | -                    |

1) Suitable at 690V for: earthed-neutral systems, overvoltage category I to III, pollution degree 3 (standard-industry); U<sub>imp</sub> = 4kV.  
Data for other conditions on request.

2) With reduced control voltage range 0,9 up to 1,0 x U<sub>s</sub> and with reduced thermal rated current I<sub>th</sub> to I<sub>e</sub>/AC15.

3) Summary switching time = release time + arc duration.

4) Release time of NC make time of NO increase when suppressor units for voltage peak protection are used (Varistor, RC-units, Diode units).

5) Data on request.

# Micro Contactors for North America

## Data according to UL508

| Main Contacts (cULus)                                 |                     | Type | K0-05D..<br>K0W05D01.. | K0-04D.. | K0-05L.. | K0-04L.. |
|---|---------------------|------|------------------------|----------|----------|----------|
| Rated operational current "General Use"               |                     | A    | 12                     | 5        | 9        | 5        |
| Rated operational power of three motors at 60Hz (3ph) | 110-120V            | hp   | 1/2                    | -        | 1/2      | -        |
|   | 200-208V            | hp   | 1                      | -        | 1        | -        |
|   | 220-240V            | hp   | 1                      | -        | 1        | -        |
|   | 277V                | hp   | 1 1/2                  | -        | 1 1/2    | -        |
| Rated operational power of AC motors at 60Hz (1ph)    | 110-120V            | hp   | 1/6                    | -        | 1/6      | -        |
|   | 200-208V            | hp   | 1/2                    | -        | 1/2      | -        |
|   | 220-240V            | hp   | 3/4                    | -        | 3/4      | -        |
| Fuse / Short-circuit current                          |                     | A/kA | 30/5                   | -        | 30/5     | -        |
| Rated voltage   |                     | VAC  | 480                    | 480      | 480      | 480      |
| <b>Auxiliary Contacts (cULus)</b>                     |                     |      |                        |          |          |          |
|   | heavy pilot duty    | AC   | B300                   | B300     | B300     | B300     |
|   | standard pilot duty | DC   | R300                   | R300     | R300     | R300     |

### Motor Rating P<sub>n</sub> = AC4

440/ 380/ 220/  
460V 400V 230V  
kW kW kW

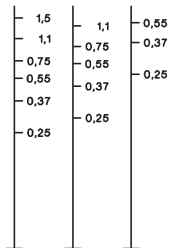

### Motor Rating P<sub>n</sub> = AC3

440/ 380/ 220/  
460V 400V 230V  
kW kW kW

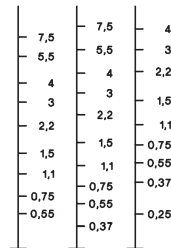

### Breaking Current I<sub>a</sub> (= I<sub>e</sub> = AC1) A

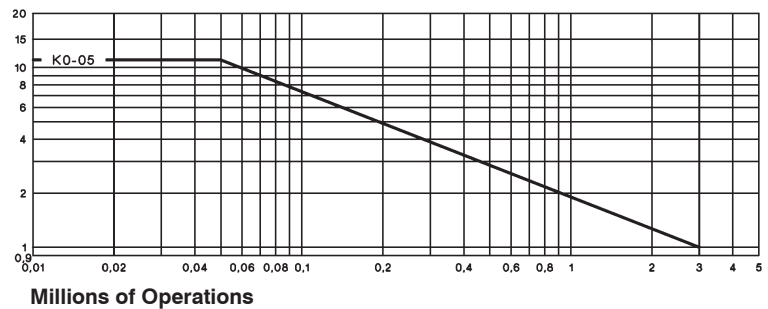

# Micro Contactors

## Dimensions

AC or DC operated  
with screw terminals

K0-04D.. (=)  
K0-05D.. (=)

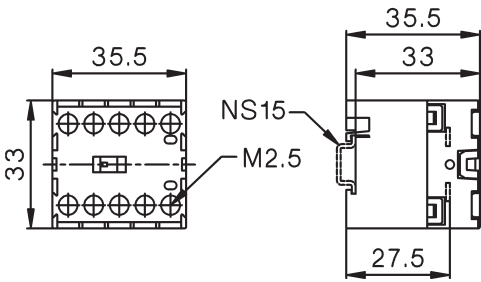

Snap-On Adapter P1039

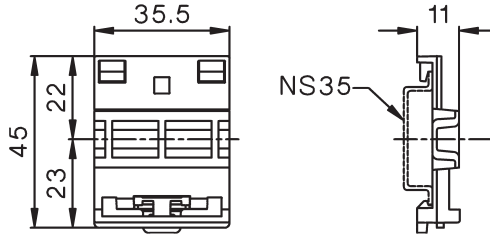

Reversing Contactors  
with screw terminals

K0W05D..MC

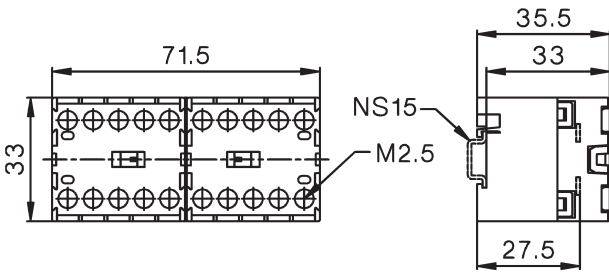

K0..D.. with Snap-On Adapter P1039

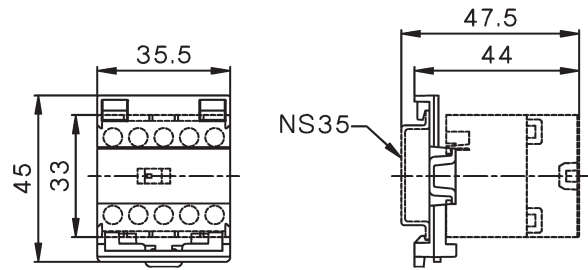

AC or DC operated  
with solder connections



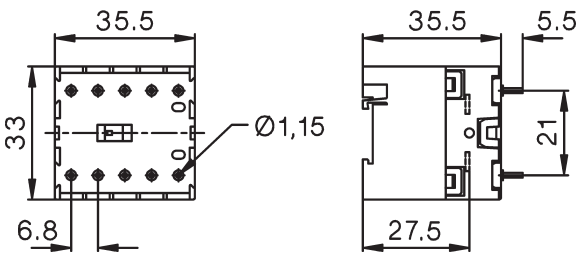

K0-04L.. (=)  
K0-05L.. (=)

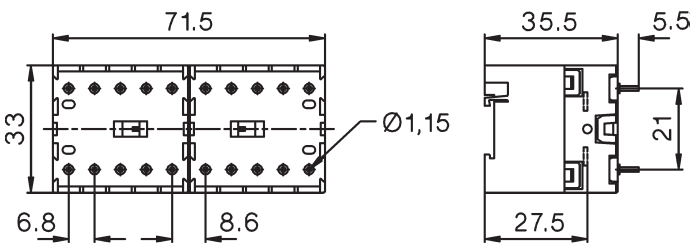

Reversing Contactors  
with solder connections

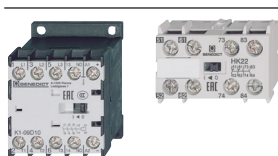
K0W05L..MC

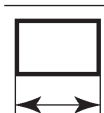

|   |  |                     |
|---|--|---------------------|
|    | <p>Mini Contactor Relays 4-pole<br/>Auxiliary Contact Blocks</p> <p>Interface Contactor Relays</p> | <p>26</p> <p>27</p> |
|    | <p>Mini Contactors<br/>Auxiliary Contact Blocks</p>  | <p>28</p>           |
|    | <p>Mini Contactors With Fast On Tab Connectors</p>   | <p>30</p>           |
|  | <p>Mini Contactors With Solder Pins</p> <p>Coil voltages</p>                                       | <p>30</p> <p>30</p> |
|  | <p>Mini Reversing Contactors<br/>Auxiliary Contact Blocks</p>                                      | <p>32</p>           |
|  | <p>Technical Data</p>  | <p>33</p>           |
|  | <p>Dimensions</p>  | <p>38</p>           |



# Mini Contactor Relays 4-pole

AC Operated

| Ratings     | Therm. Distinc. Number | Contacts <sup>2)</sup> Additional Contact | Type | Coil voltage <sup>1)</sup>                |
|-------------|------------------------|---|------|---|
| <b>AC15</b> |                        |   |      | 24V 50/60Hz                               |
| <b>230V</b> |                        |   |      | 220-230V 50Hz                             |
| <b>A</b>    |                        |   |      | 24V 50/60Hz w. protection <sup>3)</sup>   |
|             |                        |   |      | 220-230V 50Hz w. protection <sup>3)</sup> |
|             |                        |   |      | 24V 50/60Hz 24V= DC                       |
|             |                        |   |      | 220-240V 50/60Hz 220V= DC                 |

## 4-pole, With Screw Terminals



| 3 | 2 | 10 | 4 | - | 40E | 1 HK.. | K1-07D40 ... | 10 | 0,16 |
|---|---|----|---|---|-----|--------|--------------|----|------|
| 3 | 2 | 10 | 3 | 1 | 31E | 1 HK.. | K1-07D31 ... | 10 | 0,16 |
| 3 | 2 | 10 | 2 | 2 | 22E | 1 HK.. | K1-07D22 ... | 10 | 0,16 |

# Auxiliary Contact Blocks For Contactor Relays



| Ratings     | Thermal Rated Current | Contacts <sup>2)</sup> NO NC | Type | Pack pcs. | Weight kg/pc. |
|-------------|-----------------------|------------------------------|------|-----------|---------------|
| <b>AC15</b> |                       |                              |      |           |               |
| <b>230V</b> |                       |                              |      |           |               |
| <b>A</b>    |                       |                              |      |           |               |
| 3           | 2                     | 10                           | 1 1  | HK11      | 10 0,04       |
| 3           | 2                     | 10                           | - 2  | HK02      | 10 0,04       |
| 3           | 2                     | 10                           | 2 -  | HK20      | 10 0,04       |
| 3           | 2                     | 10                           | 4 -  | HK40      | 10 0,04       |
| 3           | 2                     | 10                           | 2 2  | HK22      | 10 0,04       |
| 3           | 2                     | 10                           | - 4  | HK04      | 10 0,04       |

Aux. Contact Blocks

HK11      HK02      HK20      HK40      HK22      HK04

Wiring Diagrams

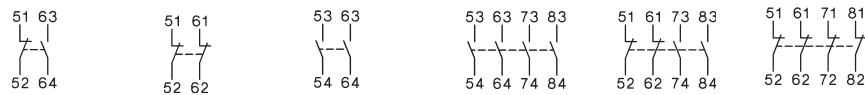



Distinc. Number according to EN50011 for Contactor Relay with Auxiliary Contact Block

|          |            |            |            |            |            |            |
|----------|------------|------------|------------|------------|------------|------------|
| K1-07D40 | <b>51E</b> | <b>42E</b> | <b>60E</b> | <b>80E</b> | <b>62E</b> | <b>44E</b> |
| K1-07D31 | 42Y        | 33Y        | 51Y        | 71Y        | 53Y        | 35Y        |
| K1-07D22 | 33Y        | 24Y        | 42Y        | 62Y        | 44Y        | 26Y        |

Preferable combinations with distinctive letter ".E" according to DIN EN 50011

1) Other coil voltages see page 30  
 2) Contacts suitable for electronic circuits, according to EN947-5-4 for rated voltage 24V DC (test ratings 17V DC, 5mA) Mirror contacts acc. IEC60947-4-1 Annex F.  
 3) with built-in coil suppressor (varistor)

# DC Solenoid Operated

| Type | Coil voltage <sup>1)</sup> |                                       | Contacts <sup>2)</sup>  |   | Additional Contact Blocks       | Pack pcs. | Weight kg/pc. | Wiring Diagrams |
|------|----------------------------|---------------------------------------|---|---|---------------------------------|-----------|---------------|-----------------|
|      | 24                         | 24VS                                  | NO  | NC  |                                 |           |               |                 |
|      | 24V= DC                    | 24V= DC with protection <sup>2)</sup> |  |  | Distinc. Number acc. to EN50011 |           |               |                 |

## 4-pole, With Screw Terminals, Coil 2,5W



|                      |   |   |     |        |    |      |   |
|----------------------|---|---|-----|--------|----|------|---|
| <b>K1-07D40= ...</b> | 4 | - | 40E | 1 HK.. | 10 | 0,19 |  |
|----------------------|---|---|-----|--------|----|------|---|

|                      |   |   |     |        |    |      |   |
|----------------------|---|---|-----|--------|----|------|---|
| <b>K1-07D31= ...</b> | 3 | 1 | 31E | 1 HK.. | 10 | 0,19 |  |
|----------------------|---|---|-----|--------|----|------|---|

|                      |   |   |     |        |    |      |   |
|----------------------|---|---|-----|--------|----|------|---|
| <b>K1-07D22= ...</b> | 2 | 2 | 22E | 1 HK.. | 10 | 0,19 |  |
|----------------------|---|---|-----|--------|----|------|---|

## 4-pole, With Screw Terminals, Coil 1,5W, 19 to 30V DC with suppressor <sup>3)</sup>



|                       |   |   |   |   |    |      |   |
|-----------------------|---|---|---|---|----|------|---|
| <b>K1-07D40= 24VR</b> | 4 | - | - | - | 10 | 0,20 |  |
|-----------------------|---|---|---|---|----|------|---|

|                       |   |   |   |   |    |      |  |
|-----------------------|---|---|---|---|----|------|--|
| <b>K1-07D31= 24VR</b> | 3 | 1 | - | - | 10 | 0,20 |  |
|-----------------------|---|---|---|---|----|------|--|

|                       |   |   |   |   |    |      |   |
|-----------------------|---|---|---|---|----|------|---|
| <b>K1-07D22= 24VR</b> | 2 | 2 | - | - | 10 | 0,20 |  |
|-----------------------|---|---|---|---|----|------|---|

1) Other coil voltages on request  
 2) Contacts suitable for electronic circuits, according to EN947-5-4 for rated voltage 24V DC (test ratings 17V DC, 5mA) Mirror contacts acc. IEC60947-4-1 Annex F.  
 3) with integrated coil suppressor (Transient Voltage Suppressor Diode)

## Mini Contactors

## AC Operated

| Power Ratings    | Rated Current | Aux. Contacts <sup>2)</sup> |            | Type | Coil voltage <sup>1)</sup>                             | Pack pcs. | Weight kg/pc. |
|------------------|---------------|-----------------------------|------------|------|--|-----------|---------------|
|                  |               | Built-in                    | Additional |      |  |           |               |
| AC2, AC3         | AC1           |                             |            |      |  |           |               |
| <b>380V</b>      |               |                             |            |      | <b>24</b> 24V 50/60Hz                                  |           |               |
| <b>400V</b> 660V |               |                             |            |      | <b>230</b> 220-230V 50Hz                               |           |               |
| <b>415V</b> 690V | 690V          |                             |            |      | <b>24VS</b> 24V 50/60Hz w. protection <sup>3)</sup>    |           |               |
| <b>kW</b> kW     | A             |                             |            |      | <b>230VS</b> 220-230V 50Hz w. protection <sup>3)</sup> |           |               |
|                  |               |                             |            |      | <b>24VM</b> 24V 50/60Hz 24V= DC                        |           |               |
|                  |               |                             |            |      | <b>230VM</b> 220-240V 50/60Hz 220V= DC                 |           |               |
|                  |               |                             |            |      |  |           |               |



### 3-pole, With Screw Terminals

| Rated Current | Rated Voltage | Rated Power | Built-in | Additional | Type    | Coil Voltage        | Pack pcs. | Weight kg/pc. |
|---------------|---------------|-------------|----------|------------|---------|---------------------|-----------|---------------|
| 4             | 4             | 20          | 1        | -          | 1 HKM.. | <b>K1-09D10 ...</b> | 10        | 0,16          |
| 5,5           | 5,5           | 20          | 1        | -          | 1 HKM.. | <b>K1-12D10 ...</b> | 10        | 0,16          |

| Rated Current | Rated Voltage | Rated Power | Built-in | Additional | Type  | Coil Voltage        | Pack pcs. | Weight kg/pc. |
|---------------|---------------|-------------|----------|------------|-------|---------------------|-----------|---------------|
| 4             | 4             | 20          | -        | 1          | 1HK.. | <b>K1-09D01 ...</b> | 10        | 0,16          |
| 5,5           | 5,5           | 20          | -        | 1          | 1HK.. | <b>K1-12D01 ...</b> | 10        | 0,16          |

### 4-pole, With Screw Terminals

| Rated Current | Rated Voltage | Rated Power | Built-in | Additional | Type  | Coil Voltage           | Pack pcs. | Weight kg/pc. |
|---------------|---------------|-------------|----------|------------|-------|------------------------|-----------|---------------|
| 4             | 4             | 20          | -        | -          | 1HK.. | <b>K1-09D00-40 ...</b> | 10        | 0,16          |
| 5,5           | 5,5           | 20          | -        | -          | 1HK.. | <b>K1-12D00-40 ...</b> | 10        | 0,16          |

## Auxiliary Contact Blocks for Contactors K1-..

| Ratings     | Thermal Rated Current | Contacts <sup>2)</sup> | Type  | Pack pcs.    | Weight kg/pc. |
|-------------|-----------------------|------------------------|-------|--------------|---------------|
| <b>AC15</b> |                       |                        |       |              |               |
| <b>230V</b> | 400V                  |                        |       |              |               |
| <b>A</b>    | A                     | A                      | NO NC |              |               |
| <b>3</b>    | 2                     | 10                     | 1 1   | <b>HKM11</b> | 10 0,04       |
| <b>3</b>    | 2                     | 10                     | - 2   | <b>HKM02</b> | 10 0,04       |
| <b>3</b>    | 2                     | 10                     | 2 2   | <b>HKM22</b> | 10 0,04       |

Aux. Contact Blocks

HKM11

HKM02

HKM22

Wiring Diagrams

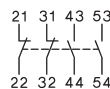

Contactors with Auxiliary Contact Block

Contacts according to EN50012

| Contactors | 21 | 12 | 32 | - | - | - | - |
|------------|----|----|----|---|---|---|---|
| K1-..D10   |    |    |    |   |   |   |   |

Contacts according to DIN EN50005

| Contactors  | 21 | 12 | 32 | 12 | 03 | 41 | 23 |
|-------------|----|----|----|----|----|----|----|
| K1-..D01    | -  | -  | -  | 12 | 03 | 41 | 23 |
| K1-..D00-40 | -  | -  | -  | 11 | 02 | 40 | 22 |

Prefer combinations according to EN50012

## Suppressor Units for Contactors K1-..



| Voltage Range V  | Capacitance / Resistance | Type             | Pack pcs. | Weight kg/pc. |
|------------------|--------------------------|------------------|-----------|---------------|
| 12 - 48V AC/DC   | 1600nF / 22 Ohm          | <b>RC-K1 24</b>  | 10        | 0,01          |
| 48 - 127V AC/DC  | 680nF / 270 Ohm          | <b>RC-K1 110</b> | 10        | 0,01          |
| 110 - 250V AC/DC | 220nF / 2200 Ohm         | <b>RC-K1 230</b> | 10        | 0,01          |

1) Other coil voltages see page 30

2) Contacts suitable for electronic circuits, according to EN947-5-4 for rated voltage 24V DC (test ratings 17V DC, 5mA) Mirror contacts acc. IEC60947-4-1 Annex F.

3) with built-in coil suppressor (varistor)

# DC Solenoid Operated

## Type

Coil voltage <sup>1)</sup>  
**24** 24V= DC  
**24VS** 24V= DC with protection <sup>3)</sup>



Aux. Contacts <sup>2)</sup>  
 Built in  
 Additional  
  
 NO NC

Additional  
 Overload  
 Relay  
 see  
 page114  
 Type

Pack  
 pcs. Weight  
 kg/pc.

Wiring Diagrams



### 3-pole, With Screw Terminals, Coil 2,5W

|                      |   |   |         |            |    |      |
|----------------------|---|---|---------|------------|----|------|
| <b>K1-09D10= ...</b> | 1 | - | 1 HKM.. | U12/16..K1 | 10 | 0,19 |
| <b>K1-12D10= ...</b> | 1 | - | 1 HKM.. | U12/16..K1 | 10 | 0,19 |

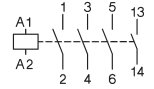

|                      |   |   |        |            |    |      |
|----------------------|---|---|--------|------------|----|------|
| <b>K1-09D01= ...</b> | - | 1 | 1 HK.. | U12/16..K1 | 10 | 0,19 |
| <b>K1-12D01= ...</b> | - | 1 | 1 HK.. | U12/16..K1 | 10 | 0,19 |

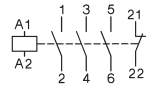

### 4-pole, With Screw Terminals, Coil 2,5W

|                         |   |   |   |            |    |      |
|-------------------------|---|---|---|------------|----|------|
| <b>K1-09D00-40= ...</b> | - | - | - | U12/16..K1 | 10 | 0,19 |
| <b>K1-12D00-40= ...</b> | - | - | - | U12/16..K1 | 10 | 0,19 |

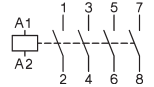

### 3-pole, With Screw Terminals, Coil 1,5W, 19 to 30V DC with suppressor <sup>3)</sup>

|                      |   |   |   |            |    |      |
|----------------------|---|---|---|------------|----|------|
| <b>K1-09D10=24VR</b> | 1 | - | - | U12/16..K1 | 10 | 0,20 |
|----------------------|---|---|---|------------|----|------|

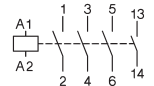

|                         |   |   |   |            |    |      |
|-------------------------|---|---|---|------------|----|------|
| <b>K1-09D01= 24VR -</b> | - | 1 | - | U12/16..K1 | 10 | 0,20 |
|-------------------------|---|---|---|------------|----|------|

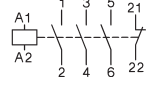

1) Other coil voltages on request

2) Contacts suitable for electronic circuits, according to EN947-5-4 for rated voltage 24V DC (test ratings 17V DC, 5mA) Mirror contacts acc. IEC60947-4-1 Annex F.

3) with integrated coil suppressor (Transient Voltage Suppressor Diode)

# Mini Contactors

# AC Operated

| Power Ratings | Rated Current | Aux. Contacts <sup>2)</sup> |            | Type | Coil voltage <sup>1)</sup>                |
|---------------|---------------|-----------------------------|------------|------|---|
|               |               | Built in                    | Additional |      |   |
| AC2, AC3      | AC1           |                             |            |      | 24V 50/60Hz                               |
| <b>380V</b>   |               |                             |            |      | 220-230V 50Hz                             |
| <b>400V</b>   | 660V          |                             |            |      | 24V 50/60Hz w. protection <sup>2)</sup>   |
| <b>415V</b>   | 690V          | 690V                        |            |      | 220-230V 50Hz w. protection <sup>2)</sup> |
| <b>kW</b>     | kW            | A                           | NO NC      | Type | 24V DC                                    |
|               |               |                             |            |      | 220-240V 50/60Hz 220V DC                  |
|               |               |                             |            |      | Pack pcs.                                 |
|               |               |                             |            |      | Weight kg/pc.                             |

### 3-pole, with Fast On Tab Connectors 1 x 6,3mm or 2 x 2,8mm



|   |   |    |   |   |         |                     |    |      |
|---|---|----|---|---|---------|---------------------|----|------|
| 4 | 4 | 16 | 1 | - | 1 HKM.. | <b>K1-09F10</b> ... | 10 | 0,16 |
| 4 | 4 | 16 | - | 1 | 1 HK..  | <b>K1-09F01</b> ... | 10 | 0,16 |

### 3-pole, with Solder Pins Ø1,15 for Printed Circuit Applications



|   |   |    |   |   |   |                     |    |      |
|---|---|----|---|---|---|---------------------|----|------|
| 4 | 4 | 16 | 1 | - | - | <b>K1-09L10</b> ... | 10 | 0,16 |
| 4 | 4 | 16 | - | 1 | - | <b>K1-09L01</b> ... | 10 | 0,16 |

### 4-pole, with Solder Pins Ø1,15 for Printed Circuit Applications

|   |   |    |   |   |   |                        |    |      |
|---|---|----|---|---|---|------------------------|----|------|
| 4 | 4 | 16 | - | - | - | <b>K1-09L00-40</b> ... | 10 | 0,16 |
|---|---|----|---|---|---|------------------------|----|------|

## Coil voltages for AC operated contactors

| Suffix to contactor type<br>e.g.<br>K1-09D10 24 | Voltage Marking at the coil for |           | Rated Control Voltage U <sub>s</sub> range for 50Hz |           |           |           | for 60Hz |      |
|---|---------------------------------|-----------|---|-----------|-----------|-----------|----------|------|
|   | 50Hz                            | for 60Hz  | min.  | max.      | min.      | max.      | min.     | max. |
|   | V                               | V         | V   | V         | V         | V         | V        | V    |
| 12  | 12                              | 12        | 11  | 12        | 12        | 12        |          |      |
| <b>24</b>                                       | <b>24</b>                       | <b>24</b> | <b>22</b>   | <b>24</b> | <b>24</b> | <b>24</b> |          |      |
| 42  | 42                              | 42        | 38,5  | 42        | 42        | 42        |          |      |
| 48  | 48                              | 48        | 48  | 50        | 48        | 52        |          |      |
| 90  | 100                             | 100       | 90  | 100       | 100       | 105       |          |      |
| 95  | 95-100                          | 105-110   | 95  | 100       | 105       | 110       |          |      |
| 100   | 100                             | 110-115   | 100   | 105       | 110       | 115       |          |      |
| 105   | 105-110                         | 115-120   | 105   | 110       | 115       | 120       |          |      |
| 110   | 110-115                         | 120-125   | 110   | 115       | 120       | 125       |          |      |
| 180   | 200                             | 200       | 185   | 200       | 200       | 210       |          |      |

| Suffix to contactor type<br>e.g.<br>K1-09D10 230 | Voltage Marking at the coil for |                | Rated Control Voltage U <sub>s</sub> range for 50Hz |            |            |            | for 60Hz |      |
|--|---------------------------------|----------------|---|------------|------------|------------|----------|------|
|  | 50Hz                            | for 60Hz       | min.  | max.       | min.       | max.       | min.     | max. |
|  | V                               | V              | V   | V          | V          | V          | V        | V    |
| 200  | 200                             | 200-220        | 195   | 205        | 200        | 220        |          |      |
| 210  | 205-215                         | 220-230        | 205   | 215        | 220        | 230        |          |      |
| 220  | 210-220                         | 220-240        | 210   | 220        | 220        | 240        |          |      |
| <b>230</b>                                       | <b>220-230</b>                  | <b>230-250</b> | <b>220</b>  | <b>230</b> | <b>230</b> | <b>250</b> |          |      |
| 240  | 230-240                         | 240-260        | 230   | 240        | 240        | 260        |          |      |
| 400  | 380-400                         | 400-440        | 380   | 400        | 400        | 440        |          |      |
| 500  | 475-500                         | 520-545        | 475   | 500        | 520        | 545        |          |      |
| 550  | 525-550                         | 600            | 525   | 550        | 570        | 600        |          |      |

**Standard voltages in bold type letters**  
**Operating range of magnet-coils: 0,85 x U<sub>s</sub> (min. value of rated control voltage) up to 1,1 x U<sub>s</sub> (max. value of rated control voltage)**

Coil not exchangeable

1) Other coil voltages see page 28

2) Contacts suitable for electronic circuits, according to EN947-5-4 for rated voltage 24V DC (test ratings 17V DC, 5mA) Mirror contacts acc. IEC60947-4-1 Annex F.

3) with built-in coil suppressor (varistor)

# DC Solenoid Operated

## Type

| Coil voltage <sup>1)</sup>                        | Aux. Contacts <sup>2)</sup> | Additional               | Pack | Weight |
|---|-----------------------------|--------------------------|------|--------|
| <b>24</b> 24V= DC                                 | Built                       | Overload                 | pcs. | kg/pc. |
| <b>24VS</b> 24V= DC with protection <sup>3)</sup> | in                          | Relay see pages 115, 117 |      |        |
| ↓   | NO NC                       | Type                     |      |        |



### 3-pole, with Fast On Tab Connectors 1 x 6,3mm or 2 x 2,8mm

|                        |   |   |                       |    |      |
|------------------------|---|---|-----------------------|----|------|
| <b>K1-09F10= . . .</b> | 1 | - | 1 HKM.. <sup>4)</sup> | 10 | 0,19 |
|------------------------|---|---|-----------------------|----|------|

Wiring Diagrams

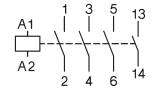

|                        |   |   |                      |    |      |
|------------------------|---|---|----------------------|----|------|
| <b>K1-09F01= . . .</b> | - | 1 | 1 HK.. <sup>4)</sup> | 10 | 0,19 |
|------------------------|---|---|----------------------|----|------|

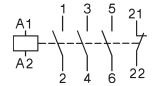

### 3-pole, with Solder Pins Ø1,15 for Printed Circuit Applications

|                        |   |   |   |    |      |
|------------------------|---|---|---|----|------|
| <b>K1-09L10= . . .</b> | 1 | - | - | 10 | 0,19 |
|------------------------|---|---|---|----|------|

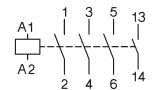

|                        |   |   |   |    |      |
|------------------------|---|---|---|----|------|
| <b>K1-09L01= . . .</b> | - | 1 | - | 10 | 0,19 |
|------------------------|---|---|---|----|------|

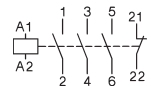

### 4-pole, with Solder Pins Ø1,15 for Printed Circuit Applications

|                           |   |   |   |    |      |
|---------------------------|---|---|---|----|------|
| <b>K1-09L00-40= . . .</b> | - | - | - | 10 | 0,19 |
|---------------------------|---|---|---|----|------|

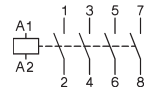

1) Other coil voltages on request  
 2) Contacts suitable for electronic circuits, according to EN947-5-4 for rated voltage 24V DC (test ratings 17V DC, 5mA) Mirror contacts acc. IEC60947-4-1 Annex F.  
 3) with integrated coil suppressor (Transient Voltage Suppressor Diode)  
 4) U12/16E K3 with U12SMK3 for single mounting

# Mini Reversing Contactors, Mechanical Interlocked

AC Operated

| Power Ratings | Rated Current | AC1      | Aux. Contacts <sup>2)</sup> |  | Type    | Coil voltage <sup>1)</sup>              | Pack pcs. | Weight kg/pc. |
|---------------|---------------|----------|-----------------------------|--|---------|---|-----------|---------------|
|               |               |          | Built-in                    | Additional on left hand side Contactor |         |   |           |               |
| AC2, AC3      |               |          |                             |  |         | 24V 50/60Hz                             |           |               |
| <b>380V</b>   |               |          |                             |  |         | 220-230V 50Hz                           |           |               |
| <b>400V</b>   | 660V          |          |                             |  |         | 24V 50/60Hz w. protection <sup>3)</sup> |           |               |
| <b>415V</b>   | 690V          | 690V     |                             |  |         | 220-230V 50Hz w. prot. <sup>3)</sup>    |           |               |
| <b>kW</b>     | <b>kW</b>     | <b>A</b> |                             |  |         | 24V 50/60Hz 24V DC                      |           |               |
|               |               |          | NO NC                       | K1 Type                                | K2 Type | 220-240V 50/60Hz 220V DC                |           |               |

## 3-pole, with Screw Terminals



|            |     |    |   |   |        |        |                       |   |      |
|------------|-----|----|---|---|--------|--------|-----------------------|---|------|
| <b>4</b>   | 4   | 20 | - | 2 | HKM11V | HKM11X | <b>K1W09D01MC ...</b> | 1 | 0,32 |
| <b>5,5</b> | 5,5 | 20 | - | 2 | HKM11V | HKM11X | <b>K1W12D01MC ...</b> | 1 | 0,32 |
| <b>4</b>   | 4   | 20 | 2 | - | HKM..  |        | <b>K1W09D10MC ...</b> | 1 | 0,32 |
| <b>5,5</b> | 5,5 | 20 | 2 | - | HKM..  |        | <b>K1W12D10MC ...</b> | 1 | 0,32 |

## 4-pole, with Screw Terminals

|            |     |    |   |   |       |  |                         |   |      |
|------------|-----|----|---|---|-------|--|-------------------------|---|------|
| <b>4</b>   | 4   | 20 | - | - | HKM.. |  | <b>K1W09D00-40MC ..</b> | 1 | 0,32 |
| <b>5,5</b> | 5,5 | 20 | - | - | HKM.. |  | <b>K1W12D00-40MC ..</b> | 1 | 0,32 |

## 3-pole, with Solder Pins Ø1,15 for Printed Circuit Applications

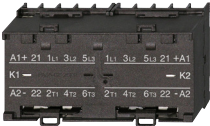

|          |   |    |   |   |   |   |                       |   |      |
|----------|---|----|---|---|---|---|-----------------------|---|------|
| <b>4</b> | 4 | 16 | - | 2 | - | - | <b>K1W09L01MC ...</b> | 1 | 0,32 |
| <b>4</b> | 4 | 16 | 2 | - | - | - | <b>K1W09L10MC ...</b> | 1 | 0,32 |

# Auxiliary Contact Blocks for Mini Reversing Contactors K1-..

| Ratings  | AC15 | 400V | Thermal Rated Current | Contacts <sup>2)</sup> |    | Type          | Pack pcs. | Weight kg/pc. |
|----------|------|------|-----------------------|------------------------|----|---------------|-----------|---------------|
|          |      |      |                       | NO                     | NC |               |           |               |
| <b>3</b> | 2    |      | 10                    | 1                      | 1  | <b>HKM11V</b> | 10        | 0,04          |
| <b>3</b> | 2    |      | 10                    | 1                      | 1  | <b>HKM11X</b> | 10        | 0,04          |



Aux. Contact Blocks

HKM11V      HKM11X

Wiring Diagrams



# Reversing Starter Connector



For Reversing Starter Types, incl. Coil Connector

| Type                          | Pack pcs. | Weight kg/pc. |
|-------------------------------|-----------|---------------|
| <b>K1W09D..MC, K1W12D..MC</b> | <b>1</b>  | <b>0,01</b>   |

1) Other coil voltages see page 30

2) Contacts suitable for electronic circuits, according to EN947-5-4 for rated voltage 24V DC (test ratings 17V DC, 5mA) Mirror contacts acc. IEC60947-4-1 Annex F.

3) with built-in coil suppressor (varistor)

# DC Solenoid Operated

## Type

**24** Coil voltage <sup>1)</sup>  
**24VS** 24V= DC  
 ↓ 24V= DC with protection <sup>2)</sup>

Additional  
 Overload  
 Relay  
 see  
 page114  
 Type

Pack pcs. Weight kg/pc.

Wiring Diagrams

### 3-pole, with Screw Terminals



|                 |            |   |      |
|-----------------|------------|---|------|
| K1W09D01MC= ... | U12/16..K1 | 1 | 0,32 |
| K1W12D01MC= ... | U12/16..K1 | 1 | 0,32 |

|                 |            |   |      |
|-----------------|------------|---|------|
| K1W09D10MC= ... | U12/16..K1 | 1 | 0,32 |
| K1W12D10MC= ... | U12/16..K1 | 1 | 0,32 |

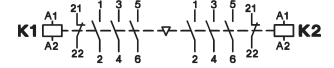

### 4-pole, with Screw Terminals

|                   |            |   |      |
|-------------------|------------|---|------|
| K1W09D00-40MC= .. | U12/16..K1 | 1 | 0,32 |
| K1W12D00-40MC= .. | U12/16..K1 | 1 | 0,32 |

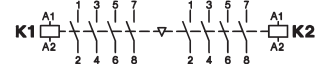

### 3-pole, with Solder Pins Ø1,15 for Printed Circuits Applications



|                 |   |   |      |
|-----------------|---|---|------|
| K1W09L01MC= ... | - | 1 | 0,32 |
|-----------------|---|---|------|

|                 |   |   |      |
|-----------------|---|---|------|
| K1W09L10MC= ... | - | 1 | 0,32 |
|-----------------|---|---|------|

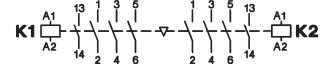
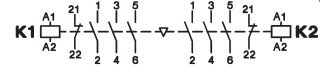

1) Other coil voltages on request  
 2) with integrated coil suppressor (Transient Voltage Suppressor Diode)



# Mini Contactors

Data according to IEC 947-4-1, VDE 0660, EN 60947-4-1

| Main Contacts   | Type   | K1-09D..          | K1-09F..                    | K1-09L..          | K1-12D..          |
|---|--|-------------------|-----------------------------|-------------------|-------------------|
| <b>Rated insulation voltage <math>U_i</math></b>                | V AC   | 690 <sup>1)</sup> | 690 <sup>1)</sup>           | 690 <sup>2)</sup> | 690 <sup>1)</sup> |
| <b>Making capacity <math>I_{eff}</math></b>                     | at $U_e = 690V$ AC                             | A                 | 165                         | 165               | 165               |
| <b>Breaking capacity <math>I_{eff}</math></b>                   | 400V AC  | A                 | 100                         | 100               | 100               |
| $\cos\varphi = 0,65$  | 500V AC  | A                 | 90                          | 90                | 90                |
|   | 690V AC  | A                 | 80                          | 80                | 80                |
| <b>Utilization category AC1</b>                                 |  |                   |                             |                   |                   |
| <b>Switching of resistive load</b>                              |  |                   |                             |                   |                   |
| Rated operational current $I_e (=I_{th})$ at 40°C, open         | <b>A</b>                                       | <b>20</b>         | <b>16</b>                   | <b>16</b>         | <b>20</b>         |
| Rated operational power of three-phase resistive loads          |  |                   |                             |                   |                   |
| 50-60Hz, $\cos\varphi = 1$                                      | 230V kW  | 7,9               | 6                           | 6                 | 7,9               |
|   | 240V kW  | 8,3               | 6,5                         | 6,5               | 8,3               |
|   | 400V kW  | 13,8              | 11                          | 11                | 13,8              |
|   | 415V kW  | 14,3              | 11,5                        | 11,5              | 14,3              |
| Rated operational current $I_e (=I_{the})$ at 60°C, enclosed    | A  | 16                | 12                          | 12                | 16                |
| Rated operational power of three-phase resistive loads          |  |                   |                             |                   |                   |
| 50-60Hz, $\cos\varphi = 1$                                      | 230V kW  | 6,3               | 4,5                         | 4,5               | 6,3               |
|   | 240V kW  | 6,7               | 5                           | 5                 | 6,7               |
|   | 400V kW  | 11                | 8                           | 8                 | 11                |
|   | 415V kW  | 11,5              | 8,5                         | 8,5               | 11,5              |
| Minimum cross-section of conductor at load with $I_e (=I_{th})$ | mm <sup>2</sup>                                | 2,5               | 2,5                         | -                 | 2,5               |
| <b>Utilization category AC2 and AC3</b>                         |  |                   |                             |                   |                   |
| <b>Switching of three-phase motors</b>                          |  |                   |                             |                   |                   |
| Rated operational current $I_e$                                 |  |                   |                             |                   |                   |
| open and enclosed   | 220V A   | 12                | 12                          | 12                | 15                |
|   | 230V A   | 11,5              | 11,5                        | 11,5              | 14,5              |
|   | 240V A   | 11                | 11                          | 11                | 14                |
|   | <b>380-400V A</b>                              | <b>9</b>          | <b>9</b>                    | <b>9</b>          | <b>12</b>         |
|   | 415-440V A                                     | 8                 | 8                           | 8                 | 11                |
|   | 500V A   | 7                 | 7                           | 7                 | 9                 |
|   | 660-690V A                                     | 5                 | 5                           | 5                 | 6,5               |
| Rated operational power of three-phase motors                   |  |                   |                             |                   |                   |
| 50-60Hz   | 220-240V kW                                    | 3                 | 3                           | 3                 | 4                 |
|   | <b>380-440V kW</b>                             | <b>4</b>          | <b>4</b>                    | <b>4</b>          | <b>5,5</b>        |
|   | 500-690V kW                                    | 4                 | 4                           | 4                 | 5,5               |
| <b>Utilization category AC4</b>                                 |  |                   |                             |                   |                   |
| <b>Switching of squirrel cage motors, inching</b>               |  |                   |                             |                   |                   |
| Rated operational current $I_e$                                 |  |                   |                             |                   |                   |
| open and enclosed   | 220V A   | 12                | 12                          | 12                | 15                |
|   | 230V A   | 11,5              | 11,5                        | 11,5              | 14,5              |
|   | 240V A   | 11                | 11                          | 11                | 14                |
|   | <b>380-400V A</b>                              | <b>9</b>          | <b>9</b>                    | <b>9</b>          | <b>12</b>         |
|   | 415-440V A                                     | 8                 | 8                           | 8                 | 11                |
|   | 500V A   | 7                 | 7                           | 7                 | 9                 |
|   | 660-690V A                                     | 5                 | 5                           | 5                 | 6,5               |
| Rated operational power of three-phase motors                   |  |                   |                             |                   |                   |
| 50-60Hz   | 220-240V kW                                    | 3                 | 3                           | 3                 | 4                 |
|   | <b>380-440V kW</b>                             | <b>4</b>          | <b>4</b>                    | <b>4</b>          | <b>5,5</b>        |
|   | 500-690V kW                                    | 4                 | 4                           | 4                 | 5,5               |
| <b>Utilization category AC5a</b>                                |  |                   |                             |                   |                   |
| <b>Switching of gas discharge lamps</b>                         |  |                   |                             |                   |                   |
| Rated operational current $I_e$                                 |  |                   |                             |                   |                   |
| per pole at 220/230V  |  |                   |                             |                   |                   |
| Fluorescent lamps,  |  |                   |                             |                   |                   |
| uncompensated and serial compensated                            | A  | 10                | 10                          | 10                | 10                |
| parallel compensated  | A  | 2                 | 2                           | 2                 | 2                 |
| dual-connection   | A  | 16                | 16                          | 16                | 16                |
| Metal halide lamps <sup>3)</sup> ,                              |  |                   |                             |                   |                   |
| uncompensated   | A  | 10                | 10                          | 10                | 10                |
| parallel compensated  | A  | 2                 | 2                           | 2                 | 2                 |
| Mercury-vapour lamps <sup>4)</sup> ,                            |  |                   |                             |                   |                   |
| uncompensated   | A  | 16                | 16                          | 16                | 16                |
| parallel compensated  | A  | 2                 | 2                           | 2                 | 2                 |
| Mixed light lamps <sup>5)</sup>                                 | A  | 16                | 61                          | 16                | 16                |
| <b>LED-Lamps</b>  |  |                   |                             |                   |                   |
| consider the inrush current of the lamp ballast                 |  |                   |                             |                   |                   |
| and $\cos\varphi$ of the lamp                                   | max. lamps per pole ( $I_{rLED} \leq I_{th}$ ) | =                 | inrush current of contactor |                   |                   |
|   |  |                   | inrush current of lamp/EVG  |                   |                   |
| max inrush current of contactor                                 | A  | 233               | 233                         | 233               | 233               |

## Utilization category AC5b Switching of incandescent lamps <sup>6)</sup>

Rated operational current  $I_e$

1) Suitable at 690V for: earthed-neutral systems, overvoltage category I to IV, pollution degree 3 (standard-industry);  $U_{imp} = 8kV$ . Data for other conditions on request.

2) Suitable at 690V for pollution degree 2,  $U_{imp} = 6kV$ .

Pollution degree 3  $U_i = 690V$  non-tracking of the printed circuit CTI  $\geq 600$

Pollution degree 3  $U_i = 500V$  non-tracking of the printed circuit CTI  $\geq 400$

Pollution degree 3  $U_i = 400V$  non-tracking of the printed circuit CTI  $\geq 100$

3) Metal halide lamps and sodium-vapour lamps (high- and low-pressure lamps)

4) High-pressure lamps

5) Blended lamps, containing a mercury high-pressure unit and a tungsten helix in a fluorescent glass bulb (daylight lamps)

6) Current inrush approx.  $16 \times I_e$

# Mini Contactors

## Data according to IEC 947-4-1, VDE 0660, EN 60947-4-1

| Main Contacts   | Type                              | K1-09D..        | K1-09F..                       | K1-09L..     | K1-12D..         |           |
|---|-----------------------------------|-----------------|--------------------------------|--------------|------------------|-----------|
| <b>Utilization category DC1</b>   |                                   |                 |                                |              |                  |           |
| <b>Switching of resistive load</b>  | 1 pole 24V                        | A               | 20                             | 16           | 16               | 20        |
| Time constant L/R ≤15ms   | 60V                               | A               | 20                             | 16           | 16               | 20        |
| Rated operational current I <sub>e</sub>  | 110V                              | A               | 5                              | 5            | 5                | 5         |
|   | 220V                              | A               | 0,6                            | 0,6          | 0,6              | 0,6       |
| 3 poles in series   | 24V                               | A               | 20                             | 20           | 20               | 20        |
|   | 60V                               | A               | 20                             | 20           | 20               | 20        |
|   | 110V                              | A               | 20                             | 20           | 20               | 20        |
|   | 220V                              | A               | 16                             | 16           | 16               | 16        |
| <b>Utilization category DC3 and DC5</b>   |                                   |                 |                                |              |                  |           |
| <b>Switching of shunt motors and series motors</b>  | 1 pole 24V                        | A               | 20                             | 16           | 16               | 20        |
| Time constant L/R ≤15ms   | 60V                               | A               | 5                              | 5            | 5                | 5         |
| Rated operational current I <sub>e</sub>  | 110V                              | A               | 1                              | 1            | 1                | 1         |
|   | 220V                              | A               | 0,15                           | 0,15         | 0,15             | 0,15      |
| 3 poles in series   | 24V                               | A               | 20                             | 16           | 16               | 20        |
|   | 60V                               | A               | 20                             | 16           | 16               | 20        |
|   | 110V                              | A               | 20                             | 16           | 16               | 20        |
|   | 220V                              | A               | 2                              | 2            | 2                | 2         |
| <b>Maximum ambient temperature</b>  |                                   |                 |                                |              |                  |           |
| Operation   | open                              | °C              | -40 to +60 (+90) <sup>1)</sup> |              |                  |           |
|   | enclosed                          | °C              | -40 to +40                     |              |                  |           |
| with thermal overload relay   | open                              | °C              | -25 to +60                     |              |                  |           |
|   | enclosed                          | °C              | -25 to +40                     |              |                  |           |
| Storage   |                                   | °C              | -50 to +90                     |              |                  |           |
| <b>Short circuit protection</b>   |                                   |                 |                                |              |                  |           |
| for contactors without thermal overload relay   |                                   |                 |                                |              |                  |           |
| Coordination-type "1" according to IEC 947-4-1  |                                   |                 |                                |              |                  |           |
| Contact welding without hazard of persons max. fuse size  | gL (gG)                           | A               | 40                             | 40           | 40               | 40        |
| Coordination-type "2" according to IEC 947-4-1  |                                   |                 |                                |              |                  |           |
| Light contact welding accepted max. fuse size   | gL (gG)                           | A               | 25                             | 25           | 25               | 25        |
| Contact welding not accepted max. fuse size   | gL (gG)                           | A               | 10                             | 10           | 10               | 10        |
| For contactors with thermal overload relay the device with the smaller admissible backup fuse (contactor or thermal overload relay) determines the fuse size. |                                   |                 |                                |              |                  |           |
| <b>Cable cross-sections</b>   |                                   |                 |                                |              |                  |           |
| for contactors without thermal overload relay   |                                   |                 |                                |              |                  |           |
| main connector  | solid or stranded                 | mm <sup>2</sup> | 0,5 - 2,5                      | Fast on      | Solder connector | 0,5 - 2,5 |
|   |                                   | flexible        | 0,5 - 2,5                      | 1x 6,3 x 0,8 | Ø 1,15           | 0,5 - 2,5 |
| Cables per clamp  | flexible with multicore cable end | mm <sup>2</sup> | 0,5 - 1,5                      | or           | -                | 0,5 - 1,5 |
|   |                                   |                 | 2                              | 2x 2,8 x 0,8 |                  | 2         |
|   | solid or stranded                 | AWG             | 18 - 14                        |              |                  | 18 - 14   |
| <b>Frequency of operations z</b>  |                                   |                 |                                |              |                  |           |
| Contactors without thermal overload relay   |                                   |                 |                                |              |                  |           |
|   | without load                      | 1/h             | 10000                          | 10000        | 10000            | 10000     |
|   | AC3, I <sub>e</sub>               | 1/h             | 600                            | 600          | 600              | 700       |
|   | AC4, I <sub>e</sub>               | 1/h             | 120                            | 120          | 120              | 150       |
|   | DC3, I <sub>e</sub>               | 1/h             | 600                            | 600          | 600              | 700       |
| <b>Mechanical life</b>  |                                   |                 |                                |              |                  |           |
| AC operated   | S x                               | 10 <sup>6</sup> | 5                              | 5            | 5                | 5         |
| DC operated   | S x                               | 10 <sup>6</sup> | 15                             | 15           | 15               | 15        |
| <b>Short time current</b>   |                                   |                 |                                |              |                  |           |
|   | 10s-current                       | A               | 96                             | 96           | 96               | 120       |
| <b>Power loss per pole</b>  |                                   |                 |                                |              |                  |           |
|   | at I <sub>e</sub> /AC3 400V       | W               | 0,15                           | 0,15         | 0,15             | 0,25      |
| <b>Resistance to shock according to IEC 68-2-27</b>   |                                   |                 |                                |              |                  |           |
| Shock time 20ms sine-wave   |                                   |                 |                                |              |                  |           |
| AC operated   | NO                                | g               | 5                              | 5            | 5                | 5         |
|   | NC                                | g               | 5                              | 5            | 5                | 5         |
| DC operated   | NO                                | g               | 8                              | 8            | 8                | 8         |
|   | NC                                | g               | 6                              | 6            | 6                | 6         |

1) With reduced control voltage range 0,9 up to 1,0 x U<sub>s</sub> and with reduced rated current I<sub>e</sub>/AC1 according to I<sub>e</sub>/AC3

# Mini Contactors

## Data according to IEC 947-5-1, VDE 0660, EN 60947-5-1

| Auxiliary Contacts   |  |  | Type  | K1-07D..<br>K1-09D..<br>K1-12D.. | K1-07D..=(VM)<br>K1-09D..=(VM)<br>K1-12D..=(VM) | K1-07D..= 24VR<br>K1-09D..= 24VR | K1-09F..=(VM)     | K1-07L..=(VM)<br>K1-09L..=(VM) | HK..              |
|--|--|--|---|----------------------------------|---|----------------------------------|-------------------|--------------------------------|-------------------|
| <b>Rated insulation voltage <math>U_i</math></b>   |  |  | V AC  | 690 <sup>1)</sup>                | 690 <sup>1)</sup>                               | 690 <sup>1)</sup>                | 690 <sup>1)</sup> | 690 <sup>2)</sup>              | 690 <sup>1)</sup> |
| <b>Thermal rated current <math>I_{th}</math> to 690V</b>   |  |  |   |                                  |   |                                  |                   |                                |                   |
| Ambient temperature  |  |  | 40°C A  | 10                               | 10  | 10                               | 10                | 10                             | 10                |
|  |  |  | 60°C A  | 6                                | 6   | 6                                | 6                 | 6                              | 6                 |
| <b>Power loss per pole</b>   |  |  | at $I_{th}$ W                                     | 0,5                              | 0,5   | 0,5                              | 0,5               | 0,5                            | 0,5               |
| <b>Utilization category AC15</b>   |  |  |   |                                  |   |                                  |                   |                                |                   |
| Rated operational current $I_e$  |  |  | 220-240V A  | 3                                | 3   | 3                                | 3                 | 3                              | 3                 |
|  |  |  | 380-415V A  | 2                                | 2   | 2                                | 2                 | 2                              | 2                 |
|  |  |  | 440V A  | 1,6                              | 1,6   | 1,6                              | 1,6               | 1,6                            | 1,6               |
|  |  |  | 500V A  | 1,2                              | 1,2   | 1,2                              | 1,2               | 1,2                            | 1,2               |
|  |  |  | 660-690V A  | 0,6                              | 0,6   | 0,6                              | 0,6               | 0,6                            | 0,6               |
| <b>Utilization category DC13</b>   |  |  |   |                                  |   |                                  |                   |                                |                   |
| Rated operational current $I_e$  |  |  | 60V A   | 2                                | 2   | 2                                | 2                 | 2                              | 2                 |
|  |  |  | 110V A  | 0,4                              | 0,4   | 0,4                              | 0,4               | 0,4                            | 0,4               |
|  |  |  | 220V A  | 0,1                              | 0,1   | 0,1                              | 0,1               | 0,1                            | 0,1               |
| <b>Maximum ambient temperature</b>   |  |  |   |                                  |   |                                  |                   |                                |                   |
| Operation  |  |  | open °C   | -40 to +60 (+90) <sup>3)</sup>   |   |                                  |                   |                                |                   |
|  |  |  | enclosed °C                                       | -40 to +40                       |   |                                  |                   |                                |                   |
| Storage  |  |  | °C  | -40 to +90                       |   |                                  |                   |                                |                   |
| <b>Short circuit protection</b>  |  |  |   |                                  |   |                                  |                   |                                |                   |
| short-circuit current 1kA,<br>contact welding not accepted<br>max. fuse size   |  |  | gL (gG) A   | 20                               | 20  | 20                               | 20                | 20                             | 20                |
| For contactors with thermal overload relay the device with the smaller admissible control fuse (contactor or thermal overload relay) determines the fuse size. |  |  |   |                                  |   |                                  |                   |                                |                   |
| <b>Power consumption of coils</b>  |  |  |   |                                  |   |                                  |                   |                                |                   |
| AC operated  |  |  | inrush VA   | 25                               | -   | -                                | 25                | 25                             | -                 |
|  |  |  | sealed VA   | 4 - 5                            | -   | -                                | 4 - 5             | 4 - 5                          | -                 |
|  |  |  | W   | 1,2                              | -   | -                                | 1,2               | 1,2                            | -                 |
| DC operated  |  |  | inrush W  | -                                | 2,5   | 1,5                              | 2,5               | 2,5                            | -                 |
| and ...VM (AC/DC)  |  |  | sealed W  | -                                | 2,5   | 1,5                              | 2,5               | 2,5                            | -                 |
| <b>Operation range of coils</b>  |  |  |   |                                  |   |                                  |                   |                                |                   |
| in multiples of control voltage $U_s$  |  |  |   | 0,85 - 1,1                       | 0,8 - 1,1                                       | 19 - 30V DC                      | 0,85 - 1,1        | 0,85 - 1,1                     | -                 |
| <b>Switching time at control voltage <math>U_s \pm 10\%</math> <sup>4) 5)</sup></b>  |  |  |   |                                  |   |                                  |                   |                                |                   |
| AC operated  |  |  | make time ms                                      | 15 - 19                          | -   | -                                | 15 - 19           | 15 - 19                        | -                 |
|  |  |  | release time ms                                   | 8 - 25                           | -   | -                                | 8 - 25            | 8 - 25                         | -                 |
|  |  |  | arc duration ms                                   | 10 - 15                          | -   | -                                | 10 - 15           | 10 - 15                        | -                 |
| DC operated  |  |  | make time ms                                      | -                                | 15 - 50   | 15 - 50                          | 15 - 50           | 15 - 50                        | -                 |
|  |  |  | release time ms                                   | -                                | 8 - 25  | 8 - 25                           | 8 - 25            | 8 - 25                         | -                 |
|  |  |  | arc duration ms                                   | -                                | 10 - 15   | 10 - 15                          | 10 - 15           | 10 - 15                        | -                 |
| <b>Cable cross-section</b>   |  |  |   |                                  |   |                                  |                   |                                |                   |
| all connectors   |  |  | solid mm <sup>2</sup>                             | 0,5 - 2,5                        | 0,5 - 2,5                                       | 0,5 - 2,5                        | Fast on           | Solder connector               | 0,5 - 2,5         |
|  |  |  | flexible mm <sup>2</sup>                          | 0,5 - 2,5                        | 0,5 - 2,5                                       | 0,5 - 2,5                        | 1x 6,3 x 0,8      | Ø 1,15                         | 0,5 - 2,5         |
|  |  |  | flexible with multicore cable end mm <sup>2</sup> | 0,5 - 1,5                        | 0,5 - 1,5                                       | 0,5 - 1,5                        | or                |                                | 0,5 - 1,5         |
|  |  |  |   |                                  |   |                                  | 2x 2,8 x 0,8      |                                |                   |
| Clamps per pole  |  |  |   | 2                                | 2   | 2                                | -                 | -                              | 2                 |
|  |  |  | solid or stranded AWG                             | 18 - 14                          | 18 - 14   | 18 - 14                          |                   |                                | 18 - 14           |

1) Suitable at 690V for: earthed-neutral systems, overvoltage category I to IV, pollution degree 3 (standard-industry):  $U_{imp} = 8kV$ .  
Data for other conditions on request.

2) Suitable at 690V for pollution degree 2,  $U_{imp} = 6kV$ .  
Pollution degree 3  $U_i = 690V$  non-tracking of the printed circuit CTI  $\geq 600$   
Pollution degree 3  $U_i = 500V$  non-tracking of the printed circuit CTI  $\geq 400$   
Pollution degree 3  $U_i = 400V$  non-tracking of the printed circuit CTI  $\geq 100$

3) With reduced control voltage range 0,9 up to  $1,0 \times U_s$  and with reduced thermal rated current  $I_{th}$  to  $I_e$  /AC15

4) Summary switching time = release time + arc duration

5) Release time of NC make time of NO increase when suppressor units for voltage peak protection are used (Varistor, RC-units, Diode units).

# Mini Contactors for North America

## Data according to UL508

| Main Contacts (cULus)                                       |          | Type                                    | K1-09D..<br>K1W09D01 | K1-09F..     | K1-09L..          | K1-07D..     | K1-12D..<br>K1W12D01 | HK..         |
|---|----------|---|----------------------|--------------|-------------------|--------------|----------------------|--------------|
| Rated operational current "General Use"                     |          | A                                       | 15                   | 15           | 20                | 10           | 20                   | 10           |
| Rated operational power of three-phase motors at 60Hz (3ph) | 110-120V | hp                                      | 1½                   | 1½           | 1½                | -            | 2                    | -            |
|   | 200-208V | hp                                      | 3                    | 3            | 3                 | -            | 3                    | -            |
|   | 220-240V | hp                                      | 3                    | 3            | 3                 | -            | 3                    | -            |
|   | 440-480V | hp                                      | 5                    | 5            | 5                 | -            | 7½                   | -            |
|   | 550-600V | hp                                      | 7½                   | 7½           | 7½                | -            | 10                   | -            |
| Rated operational power of AC motors at 60Hz (1ph)          | 110-120V | hp                                      | ½                    | ½            | ½                 | -            | ¾                    | -            |
|   | 200-208V | hp                                      | 1                    | 1            | 1                 | -            | 1½                   | -            |
|   | 220-240V | hp                                      | 1½                   | 1½           | 1½                | -            | 2                    | -            |
| Fuse / Short-circuit current                                |          | A/kA                                    | 30/5                 | 30/5         | 30/5              | -            | 30/5                 | -            |
| Rated voltage   |          | V AC                                    | 600                  | 600          | 600 <sup>1)</sup> | 600          | 600                  | 600          |
| <b>Auxiliary Contacts (cULus)</b>                           |          | heavy pilot duty<br>standard pilot duty | AC<br>DC             | A600<br>Q600 | A600<br>Q600      | A600<br>Q600 | A600<br>Q600         | A600<br>Q600 |

### Motor Rating P<sub>n</sub> = AC4

| 660V | 500V | 380V | 220V |
|------|------|------|------|
| 690V | 400V | 400V | 230V |
| kW   | kW   | kW   | kW   |
| 110  | 75   | 55   | 30   |
| 90   | 55   | 45   | 22   |
| 75   | 45   | 37   | 18,5 |
| 55   | 37   | 30   | 15   |
| 45   | 30   | 22   | 11   |
| 37   | 22   | 18,5 | 7,5  |
| 30   | 18,5 | 15   | 5,5  |
| 22   | 15   | 11   | 4    |
| 18,5 | 11   | 7,5  | 3    |
| 15   | 7,5  | 5,5  | 2,2  |
| 11   | 5,5  | 4    | 1,5  |
| 7,5  | 4    | 3    | 1,1  |
| 5,5  | 3    | 2,2  | 0,75 |
| 4    | 2,2  | 1,5  | 0,55 |
| 3    | 1,5  | 1,1  | 0,37 |
| 2,2  | 1,1  | 0,75 | 0,25 |
| 1,5  | 0,75 | 0,55 |      |
| 1,1  | 0,55 | 0,37 |      |
| 0,75 | 0,37 | 0,25 |      |
| 0,55 | 0,25 |      |      |
| 0,37 |      |      |      |
| 0,25 |      |      |      |

### Motor Rating P<sub>n</sub> = AC3

| 660V | 500V | 380V | 220V |
|------|------|------|------|
| 690V | 400V | 400V | 230V |
| kW   | kW   | kW   | kW   |
| 600  | 400  | 315  | 200  |
| 600  | 315  | 250  | 160  |
| 400  | 250  | 200  | 132  |
| 315  | 200  | 160  | 110  |
| 250  | 160  | 132  | 90   |
| 200  | 132  | 110  | 75   |
| 160  | 110  | 90   | 55   |
| 132  | 90   | 75   | 45   |
| 110  | 75   | 55   | 37   |
| 90   | 55   | 45   | 30   |
| 75   | 45   | 37   | 22   |
| 55   | 37   | 30   | 18,5 |
| 45   | 30   | 22   | 15   |
| 37   | 22   | 18,5 | 11   |
| 30   | 18,5 | 15   | 7,5  |
| 22   | 15   | 11   | 5,5  |
| 18,5 | 11   | 7,5  | 4    |
| 15   | 7,5  | 5,5  | 3    |
| 11   | 5,5  | 4    | 2,2  |
| 7,5  | 4    | 3    | 1,5  |
| 5,5  | 3    | 2,2  | 1,1  |
| 4    | 2,2  | 1,5  | 0,75 |
| 3    | 1,5  | 1,1  | 0,55 |
| 2,2  | 1,1  | 0,75 | 0,37 |
| 1,5  | 0,75 | 0,55 | 0,25 |
| 1,1  | 0,55 | 0,37 |      |
| 0,75 | 0,37 | 0,25 |      |
| 0,55 | 0,25 |      |      |
| 0,37 |      |      |      |
| 0,25 |      |      |      |

### Breaking Current I<sub>a</sub> (= I<sub>e</sub> = AC1) A

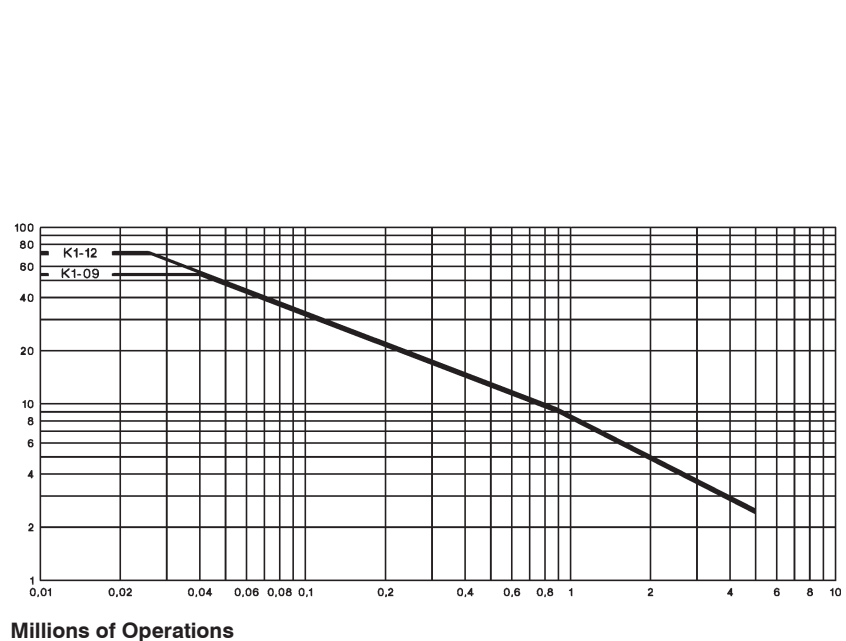

| 1) Pollution degree | CTI - PWB | U <sub>i</sub> |
|---------------------|-----------|----------------|
| 2                   | ≥ 100     | 600V           |
| 3                   | ≥ 400     | 480V           |
| 3                   | 100 - 400 | 240V           |

# Mini Contactors

## Dimensions

AC and DC operated  
with screw terminals

K1-07D..  
K1-09D..  
K1-12D..

with fast on terminals

K1-07F..  
K1-09F..

AC and DC operated  
with solder connections  
K1-07L..  
K1-09L..

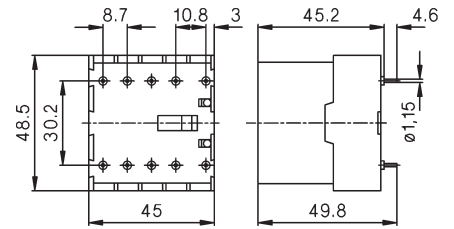
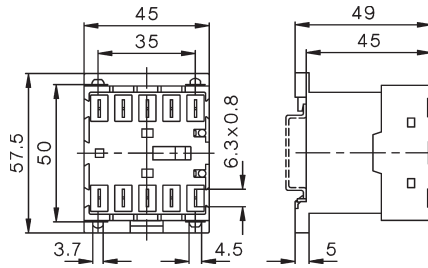
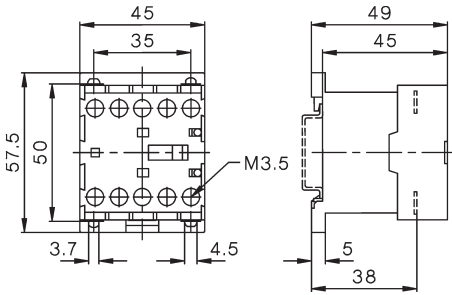

## Auxiliary Contact Blocks

HK..

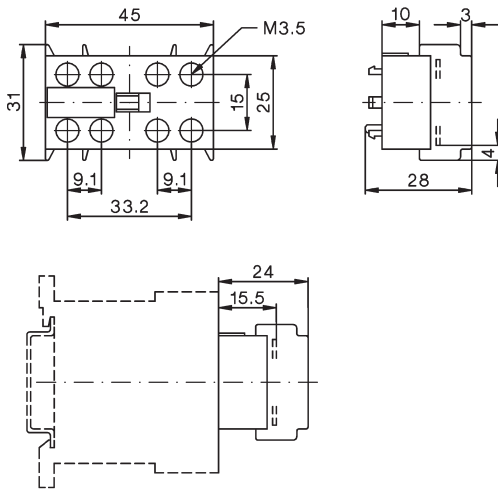

## Suppressor Units

RC-K1

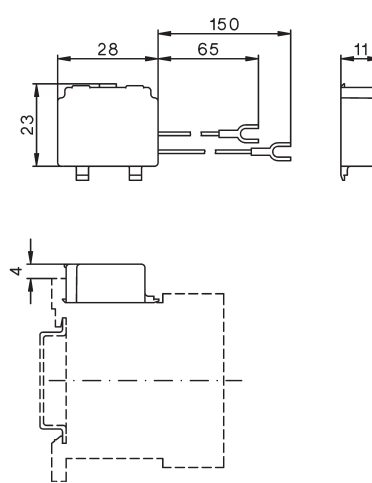

## Reversing Contactors

K1W09D..MC  
K1W12D..MC

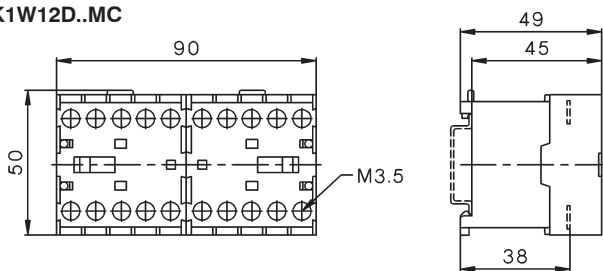

## Reversing Contactors

K1W09L..MC

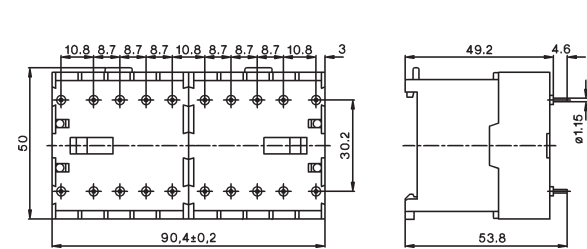

K1-09 + U12/16.. K1  
K1-12

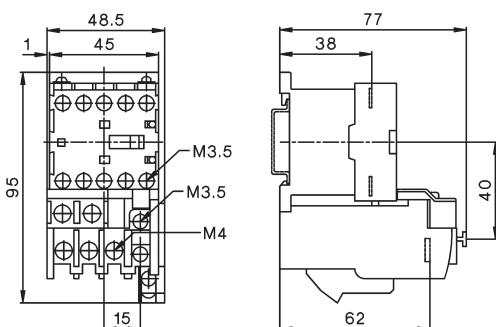

K1W09D..MC + U12/16E K1  
K1W09D..MC + U12/16E K1

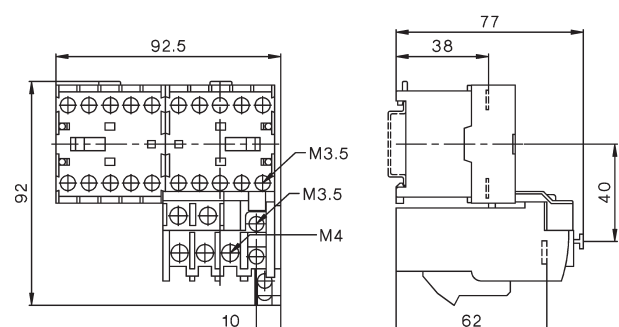



Contactor Relays 4-pole, AC Operated

40



Auxiliary Contact Blocks 1-pole

40



Contactor Relays 4-pole, DC Operated

41



Technical Data

42

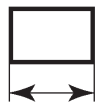

Dimensions

44

## Contactors Relays

AC Operated

| Ratings |                      | Contacts |                         |                           |      | Type        | Coil voltage <sup>1)</sup> |               |               |               |
|---------|----------------------|----------|-------------------------|---------------------------|------|-------------|----------------------------|---------------|---------------|---------------|
| AC15    | Therm. Rated Current | Built-in | Distinc. Number acc. to | Additional Contact Blocks |      | 24          | 110                        | 230           | 400           |               |
| 230V    | 400V                 |          |                         |                           |      | 24V 50/60Hz | 110V 50Hz                  | 110-120V 60Hz | 220-240V 50Hz | 230-264V 60Hz |
| A       | A                    | $I_{th}$ | NO NC                   | EN50011                   | Type |             |                            |               | 380-415V 50Hz | 400-440V 60Hz |



### 4-pole, contacts suitable for electronic circuits according to EN947-5-4<sup>2)</sup>

| 4 | 2 | 10 | 4 | - | 40E | max. 4 | K3-07ND40 ... | 1 | 0,22 |
|---|---|----|---|---|-----|--------|---------------|---|------|
| 4 | 2 | 10 | 3 | 1 | 31E | HN..   | K3-07ND31 ... | 1 | 0,22 |
| 4 | 2 | 10 | 2 | 2 | 22E |        | K3-07ND22 ... | 1 | 0,22 |
| 4 | 2 | 10 | - | 4 | 04E |        | K3-07ND04 ... | 1 | 0,22 |

## Auxiliary Contact Blocks <sup>3)</sup>

| Ratings |      | Thermal Rated Current | Contacts <sup>2)</sup> |    |    |    | Type | Pack pcs. | Weight kg/pc. |
|---------|------|-----------------------|------------------------|----|----|----|------|-----------|---------------|
| AC15    | 230V | 400V                  | NO                     | NC | EM | LB |      |           |               |
| A       | A    | A                     |                        |    |    |    |      |           |               |



### 1-pole, contacts suitable for electronic circuits according to EN947-5-4<sup>2)</sup>

| 3 | 2 | 10 | 1 | - | - | - | HN10  | 10 | 0,02 |
|---|---|----|---|---|---|---|-------|----|------|
| 3 | 2 | 10 | - | 1 | - | - | HN01  | 10 | 0,02 |
| 3 | 2 | 10 | - | - | 1 | - | HN10U | 10 | 0,02 |
| 3 | 2 | 10 | - | - | - | 1 | HN01U | 10 | 0,02 |

### 1-pole, for high switching capacity

| 6 | 3 | 25 | 1 | - | - | - | HA10 | 10 | 0,03 |
|---|---|----|---|---|---|---|------|----|------|
| 6 | 3 | 25 | - | 1 | - | - | HA01 | 10 | 0,03 |

Accessories see page 52 - 55

1) Other coil voltages see page 57

2) Contacts suitable for electronic circuits, according to EN947-5-4 for rated voltage 24V DC (test ratings 17V DC, 5mA) Mirror contacts acc. IEC60947-4-1 Annex F.

3) Technical Data see page 62

## DC Operated

| Type | Coil voltage <sup>1)</sup> |         | Contacts |                         |                           | Pack pcs. | Weight kg/pc. | Wiring Diagrams |
|------|----------------------------|---------|----------|-------------------------|---------------------------|-----------|---------------|-----------------|
|      |                            |         | Built-in | Distinc. Number acc. to | Additional Contact Blocks |           |               |                 |
|      | <b>24</b>                  | 24V DC  |          |                         |                           |           |               |                 |
|      | <b>48</b>                  | 48V DC  |          |                         |                           |           |               |                 |
|      | <b>110</b>                 | 110V DC |          |                         |                           |           |               |                 |
|      | <b>220</b>                 | 220V DC |          |                         |                           |           |               |                 |
|      | ↓                          |         | NO       | NC                      | EN50011                   | Type      |               |                 |



### 3W Coil power, for high switching capacity <sup>3)</sup>

|                      |   |   |     |        |   |      |
|----------------------|---|---|-----|--------|---|------|
| <b>KG3-07A40</b> ... | 4 | - | 40E | max. 4 | 1 | 0,53 |
| <b>KG3-07A31</b> ... | 3 | 1 | 31E | HN..   | 1 | 0,53 |
| <b>KG3-07A22</b> ... | 2 | 2 | 22E | oder   | 1 | 0,53 |
| <b>KG3-07A04</b> ... | - | 4 | 04E | HA..   | 1 | 0,53 |

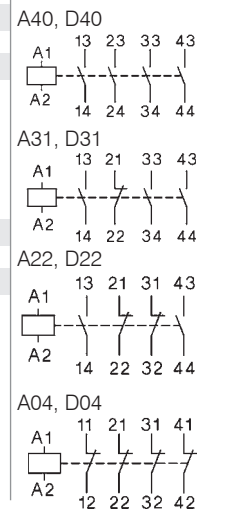

### 3W Coil power, for electronic circuits <sup>2)3)</sup>

|                      |   |   |     |        |   |      |
|----------------------|---|---|-----|--------|---|------|
| <b>KG3-07D40</b> ... | 4 | - | 40E | max. 4 | 1 | 0,53 |
| <b>KG3-07D31</b> ... | 3 | 1 | 31E | HN..   | 1 | 0,53 |
| <b>KG3-07D22</b> ... | 2 | 2 | 22E |        | 1 | 0,53 |
| <b>KG3-07D04</b> ... | - | 4 | 04E |        | 1 | 0,53 |

### with double winding coil, for electronic circuits <sup>2)</sup>

|                       |   |    |     |        |   |      |
|-----------------------|---|----|-----|--------|---|------|
| <b>K3-07ND40=</b> ... | 4 | -  | 40E | max. 3 | 1 | 0,25 |
| <b>K3-07ND31=</b> ... | 3 | 1  | 31E | HN..   | 1 | 0,25 |
| <b>K3-07ND22=</b> ... | 2 | 2  | 22E |        | 1 | 0,25 |
| <b>K3-07ND04=</b> ... |   | -4 | 04E |        | 1 | 0,25 |

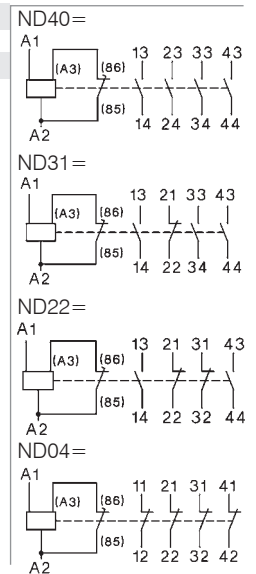

- 1) Other coil voltages on request
- 2) Contacts suitable for electronic circuits, according to EN947-5-4 for rated voltage 24V DC (test ratings 17V DC, 5mA) Mirror contacts acc. IEC60947-4-1 Annex F.
- 3) with integrated coil suppressor (Transient Voltage Suppressor Diode)



# Contactors Relays

## Data according to IEC 947-5-1, VDE 0660, EN 60947-5-1

|   |  |  | Type  | K3-07ND                        | K3-07ND=  | KG3-07A               | KG3-07D               |
|---|--|--|---|--------------------------------|-----------|-----------------------|-----------------------|
| <b>Rated insulation voltage <math>U_i</math><sup>1)</sup></b> |  |  | V AC  | 690                            | 690       | 690                   | 690                   |
| <b>Thermal rated current <math>I_{th}</math> to 690V</b>      |  |  |   |                                |           |                       |                       |
| Ambient temperature   |  |  | 40°C A  | 10                             | 10        | 20                    | 10                    |
|   |  |  | 60°C A  | 6                              | 6         | 16                    | 6                     |
| <b>Frequency of operations z</b>                              |  |  | 1/h   | 10000                          | 10000     | 10000                 | 10000                 |
| <b>Mechanical life</b>  |  |  | S x 10 <sup>6</sup>                               | 10                             | 10        | 10                    | 50                    |
| <b>Utilization category AC15</b>                              |  |  |   |                                |           |                       |                       |
| Rated operational current $I_e$                               |  |  | 220-240V A  | 4                              | 4         | 12                    | 4                     |
|   |  |  | 380-415V A  | 2                              | 2         | 4                     | 2                     |
|   |  |  | 440V A  | 1,6                            | 1,6       | 4                     | 1,6                   |
|   |  |  | 500V A  | 1,2                            | 1,2       | 3                     | 1,2                   |
|   |  |  | 660-690V A  | 0,6                            | 0,6       | 1                     | 0,6                   |
| <b>Utilization category DC13</b>                              |  |  |   |                                |           |                       |                       |
| Rated operational current $I_e$                               |  |  | 24-60V A  | 3,5                            | 3,5       | 8                     | 3,5                   |
| per pole  |  |  | 110V A  | 0,5                            | 0,5       | 1                     | 0,5                   |
|   |  |  | 220V A  | 0,1                            | 0,1       | 0,1                   | 0,1                   |
| <b>Power consumption of coils</b>                             |  |  |   |                                |           |                       |                       |
| AC operated   |  |  | inrush VA   | 30 - 45                        | -         | -                     | -                     |
|   |  |  | sealed VA   | 7 - 10                         | -         | -                     | -                     |
|   |  |  | W   | 2,6 - 3                        | -         | -                     | -                     |
| DC operated   |  |  | inrush W  | -                              | 75        | 3                     | 3                     |
|   |  |  | sealed W  | -                              | 2         | 3                     | 3                     |
| <b>Operation range of coils</b>                               |  |  |   |                                |           |                       |                       |
| in multiples of control voltage $U_s$                         |  |  |   | 0,85 - 1,1                     | 0,8 - 1,1 | 0,8 - 1,1             | 0,8 - 1,1             |
| <b>Switching time</b> at control voltage $U_s \pm 10\%$       |  |  |   |                                |           |                       |                       |
| make time   |  |  | ms  | 8 - 16                         | 8 - 16    | 65 - 85               | 65 - 85               |
| release time  |  |  | ms  | 5 - 13                         | 5 - 13    | 20 - 30 <sup>3)</sup> | 20 - 30 <sup>3)</sup> |
| <b>Maximum ambient temperature</b>                            |  |  |   |                                |           |                       |                       |
| Operation   |  |  | open °C   | -40 to +60 (+90) <sup>2)</sup> |           |                       |                       |
|   |  |  | enclosed °C                                       | -40 to +40                     |           |                       |                       |
| Storage   |  |  | °C  | -40 to +90                     |           |                       |                       |
| <b>Short circuit protection</b>                               |  |  |   |                                |           |                       |                       |
| short-circuit current 1kA,<br>contact welding not accepted    |  |  |   |                                |           |                       |                       |
| max. fuse size  |  |  | gL (gG) A   | 20                             | 20        | 25                    | 20                    |
| <b>Cable cross-section</b>                                    |  |  |   |                                |           |                       |                       |
| Connector   |  |  | solid mm <sup>2</sup>                             | 0,75 - 6                       |           |                       |                       |
|   |  |  | flexible mm <sup>2</sup>                          | 1 - 4                          |           |                       |                       |
|   |  |  | flexible with multicore cable end mm <sup>2</sup> | 0,75 - 4                       |           |                       |                       |
| Magnet coil   |  |  | solid mm <sup>2</sup>                             | 0,75 - 2,5                     |           |                       |                       |
|   |  |  | flexible mm <sup>2</sup>                          | 0,75 - 2,5                     |           |                       |                       |
|   |  |  | flexible with multicore cable end mm <sup>2</sup> | 0,5 - 1,5                      |           |                       |                       |
| Clamps per pole   |  |  |   | 2                              |           |                       |                       |
| Connector   |  |  | solid AWG   | 18 - 10                        |           |                       |                       |
|   |  |  | flexible AWG                                      | 18 - 10                        |           |                       |                       |
| Clamps per pole   |  |  |   | 2                              |           |                       |                       |
| Magnet coil   |  |  | solid AWG   | 14 - 12                        |           |                       |                       |
|   |  |  | flexible AWG                                      | 18 - 12                        |           |                       |                       |
| Clamps per pole   |  |  |   | 2                              |           |                       |                       |

## Data according to UL508

|   |  |  |                  |      |      |      |      |
|---|--|--|------------------|------|------|------|------|
| Rated operational current "General Use" |  |  | A                | 10   | 10   | 20   | 10   |
| Rated operational voltage               |  |  | max. V AC        | 600  | 600  | 600  | 600  |
| <b>Auxiliary Contacts</b>               |  |  | heavy pilot duty | A600 | A600 | A600 | A600 |

1) Suitable at 690V for: earthed-neutral systems, overvoltage category I to IV, pollution degree 3 (standard-industry):  $U_{imp} = 8kV$ .  
Data for other conditions on request.

2) With reduced control voltage range 0,9 up to 1,0 x  $U_s$  and with reduced thermal rated current  $I_{th}$  according to  $I_e/AC15$

3) with built-in coil suppressor

# Contactor Relays

## Position of Terminals

AC operated

**K3-07ND22**

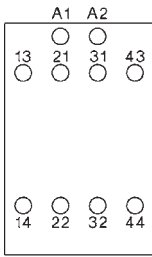

**K3-07ND31**

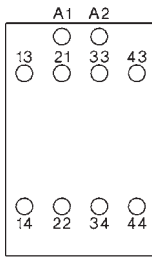

**K3-07ND40**

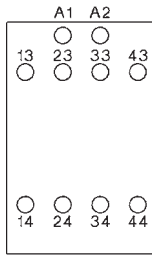

**K3-07ND04**

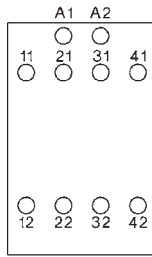

DC operated with double wound coil

**K3-07ND22=**

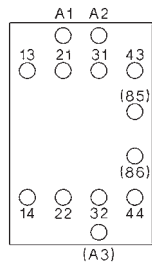

**K3-07ND31=**

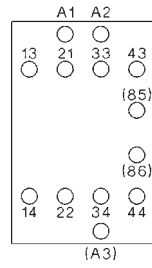

**K3-07ND40=**

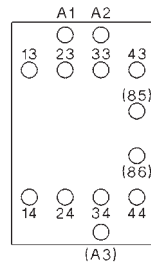

**K3-07ND04=**

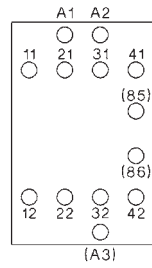

DC solenoid operated

**KG3-07A22**  
**KG3-07D22**

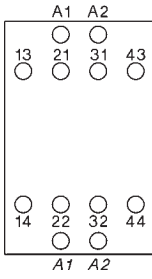

**KG3-07A31**  
**KG3-07D31**

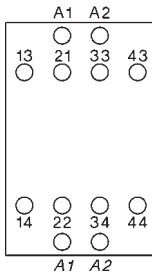

**KG3-07A40**  
**KG3-07D40**

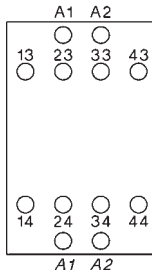

**KG3-07A04**  
**KG3-07D04**

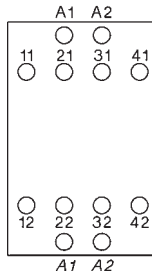

# Contactors Relays

## Dimensions

AC operated

K3-07ND..

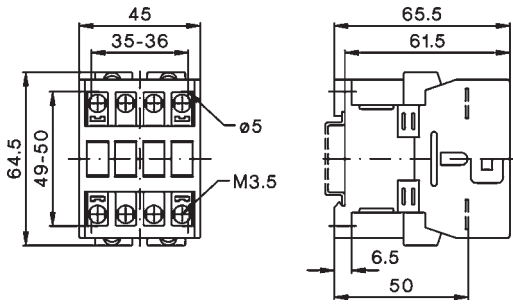

DC solenoid operated

KG3-07..

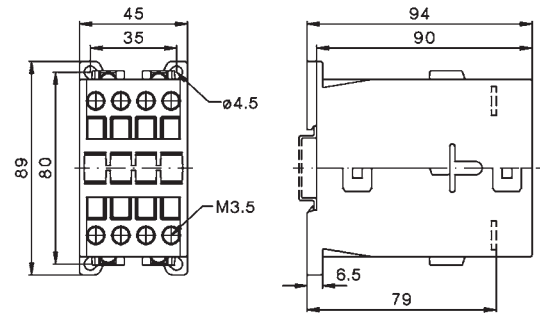

DC operated with double winding coil

K3-07ND.. =

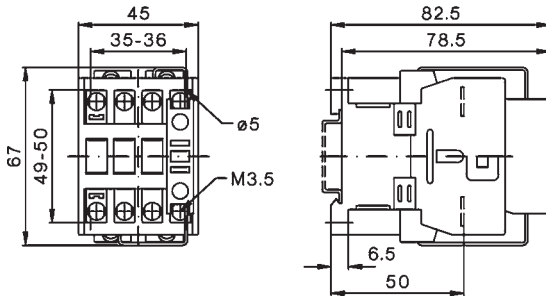





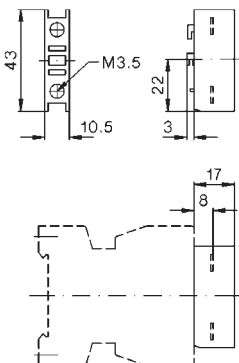



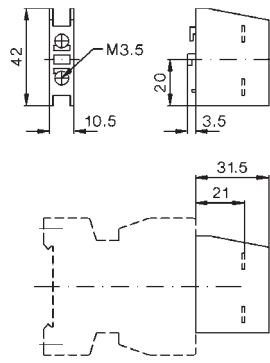







Auxiliary contact blocks

HN10, HN01

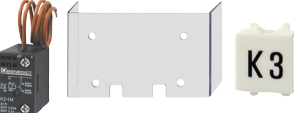

HA10, HA01



|   |  |    |
|---|--|----|
|    | Contactor overview   | 46 |
|    | Contactors 3-pole, AC Operated   | 48 |
|    | Contactors 3-pole, DC Operated   | 49 |
|    | Contactors 4-pole  | 50 |
|    | Capacitor Switching Contactors   | 51 |
|    | Auxiliary Contact Blocks<br>Snap-on Momentary Contacts<br>Additional Fourth Poles for Contactors | 52 |
|   | Pneumatic Timers<br>Electronic Timers On-delay<br>Electronic Timers Off-delay                    | 53 |
|  | Mechanical Interlocks<br>Latches<br>Additional Terminals, Parallel Connectors                    | 54 |
|  | Indicator Units<br>Fuse Holders<br>Suppressor Units  | 55 |
|  | Interface<br>Terminal Covers<br>Mounting Parts   | 56 |
|  | Control Voltages   | 57 |
|  | Spare Coils AC-operated<br>Feeder Groups   | 58 |
|  | Spare Coils DC-operated<br>Spare Contacts  | 59 |
|  | Technical Data   | 62 |
|  | Dimensions   | 82 |

# Contactors 3-pole

- Up to 1200A AC3
- Up to 1350A AC1
- DIN-rail mounting up to AC3 115A
- International Approvals
- Data according to IEC 947 / EN 60947



| Ratings                        |                      | 10A                                   | 14A                                   | 18A                                | 22A                                | 24A                                       | 32A                                   | 40A                            | 50A   | 62A            | 74A   | 90A                 | 115A   |
|--------------------------------|----------------------|---------------------------------------|---------------------------------------|------------------------------------|------------------------------------|---|---------------------------------------|--------------------------------|-------|----------------|-------|---------------------|--------|
| AC3 400V                       | Motor                | 4kW                                   | 5,5kW                                 | 7,5kW                              | 11kW                               | 11kW                                      | 15kW                                  | 18,5kW                         | 22kW  | 30kW           | 37kW  | 45kW                | 55kW   |
|                                | 380-400V<br>660-690V | 5,5kW                                 | 7,5kW                                 | 10kW                               | 10kW                               | 15kW                                      | 18,5kW                                | 18,5kW                         | 30kW  | 37kW           | 45kW  | 55kW                | 55kW   |
| AC1                            | 690V at 40°C         | 25A                                   | 25A                                   | 32A                                | 32A                                | 50A                                       | 65A                                   | 80A                            | 110A  | 120A           | 130A  | 160A                | 200A   |
| Type                           | K3-                  | 10ND10                                | 14ND10                                | 18ND10                             | 22ND10                             | 24A00                                     | 32A00                                 | 40A00                          | 50A00 | 62A00          | 74A00 | 90A00               | 115A00 |
| Auxiliary contacts             |                      | 1NO                                   | 1NO                                   | 1NO                                | 1NO                                | -   | -                                     | -                              | -     | -              | -     | -                   | -      |
| Type                           | K3-                  | 10ND01                                | 14ND01                                | 18ND01                             | 22ND01                             |   |                                       |                                |       |                |       |                     |        |
| Auxiliary contacts             |                      | 1NC                                   | 1NC                                   | 1NC                                | 1NC                                |   |                                       |                                |       |                |       |                     |        |
| Cable cross-section            |                      |                                       |                                       |                                    |                                    |   |                                       |                                |       |                |       |                     |        |
| Solid                          | mm <sup>2</sup>      | 0,75 - 6                              |                                       |                                    |                                    | 1,5 - 25                                  |                                       | 4 - 50                         |       | 10 - 120       |       |                     |        |
| Flexible                       | mm <sup>2</sup>      | 1 - 4                                 |                                       |                                    |                                    | 2,5 - 16                                  |                                       | 10 - 35                        |       | 10 - 95        |       |                     |        |
| Auxiliary contact              |                      |                                       |                                       |                                    |                                    |   |                                       |                                |       |                |       |                     |        |
| I <sub>th</sub> 40°C           | A                    | 10                                    |                                       |                                    |                                    | -   |                                       | -                              |       | -              |       | -                   |        |
| AC15 230V                      | A                    | 3                                     |                                       |                                    |                                    | -   |                                       | -                              |       | -              |       | -                   |        |
| 400V                           | A                    | 2                                     |                                       |                                    |                                    | -   |                                       | -                              |       | -              |       | -                   |        |
| Power consumption              |                      |                                       |                                       |                                    |                                    |   |                                       |                                |       |                |       |                     |        |
| Inrush VA                      |                      | 33 - 45                               |                                       |                                    |                                    | 90 - 115                                  |                                       | 140 - 165                      |       | 280            |       |                     |        |
| of coils hold VA               |                      | 7 - 10                                |                                       |                                    |                                    | 9 - 13                                    |                                       | 13 - 18                        |       | 5              |       |                     |        |
| Operation range of coils       |                      | 0,85 - 1,1                            |                                       |                                    |                                    | 0,85 - 1,1                                |                                       | 0,85 - 1,1                     |       | 0,85 - 1,1     |       |                     |        |
| Mounting                       |                      | 35mm DIN-rail or base                 |                                       |                                    |                                    |   |                                       |                                |       |                |       | 2x DIN-rail or base |        |
| Additional aux. contact blocks |                      |                                       |                                       |                                    |                                    |   |                                       |                                |       |                |       |                     |        |
| Front mounting                 | Type                 | HN10<br>1NO<br>f. low level switching | HN01<br>1NC<br>f. low level switching | HA10<br>1NO<br>25A I <sub>th</sub> | HA01<br>1NC<br>25A I <sub>th</sub> | max.<br>4 HN..<br>or<br>4 HA..            |                                       | max.<br>7 HN..<br>or<br>7 HA.. |       |                |       |                     |        |
| Side mounting                  | Type                 | -                                     | -                                     | -                                  | -                                  | HB11<br>1NO+1NC<br>f. low level switching | HB02<br>2NC<br>f. low level switching | max.<br>2 HB..                 |       |                |       |                     |        |
| Overload Relay (thermal)       |                      |                                       |                                       |                                    |                                    |   |                                       |                                |       |                |       |                     |        |
| Single phase protection        |                      |                                       |                                       |                                    |                                    |   |                                       |                                |       |                |       |                     |        |
| Temperature compensation       |                      |                                       |                                       |                                    |                                    |   |                                       |                                |       |                |       |                     |        |
| Trip and alarm contacts        |                      |                                       |                                       |                                    |                                    |   |                                       |                                |       |                |       |                     |        |
| Type                           |                      | U3/32                                 |                                       |                                    |                                    | U3/42                                     |                                       |                                |       | U3/74          |       | U85                 |        |
|                                |                      | U12/16..K3                            |                                       |                                    |                                    |   |                                       |                                |       |                |       |                     |        |
| Number of Setting Ranges from  |                      | 16<br>0,12 - 30A                      |                                       | 16<br>0,12 - 32A                   |                                    | 4<br>10 - 42A                             |                                       | 5<br>20 - 74A                  |       | 2<br>60 - 120A |       |                     |        |
| Busbar sets                    |                      | -                                     |                                       |                                    |                                    |   |                                       |                                |       |                |       |                     |        |

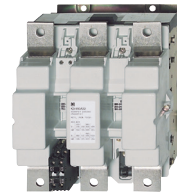

Contactor, Motor-Starter

Circuit Breakers

Manual Motor-Starters







Switches

AC-Main Switches

DC-Switch Disconnect



Push Buttons

Representatives, Suppliers

|   |  |  |  |  |   |  |   |   |   |  |   |
|---|--|--|--|--|---|--|---|---|---|--|---|
| <b>150A</b><br><b>75kW</b><br>90kW<br>250A  | <b>175A</b><br><b>90kW</b><br>110kW<br>300A          | <b>210A</b><br><b>110kW</b><br>160kW<br>350A | <b>260A</b><br><b>132kW</b><br>210kW<br>450A | <b>315A</b><br><b>160kW</b><br>250kW<br>600A | <b>450A</b><br><b>250kW</b><br>375kW<br>700A  | <b>550A</b><br><b>300kW</b><br>475kW<br>800A         | <b>700A</b><br><b>400kW</b><br>630kW<br>1000A | <b>860A</b><br><b>500kW</b><br>700kW<br>1100A | <b>1000A</b><br><b>580kW</b><br>850kW<br>1200A  | <b>1200A</b><br><b>680kW</b><br>1000kW<br>1350A                                      |   |
| <b>151A00</b><br>-  | <b>176A00</b><br>-                                   | <b>210A00</b><br>-                           | <b>260A00</b><br>-                           | <b>316A00</b><br>-                           | <b>450A22</b><br>2NO+2NC  | <b>550A22</b><br>2NO+2NC                             | <b>700A22</b><br>2NO+2NC                      | <b>860A22</b><br>2NO+2NC                      | <b>1000A12</b><br>1NO+2NC   | <b>1200A12</b><br>1NO+2NC  |   |
| 2 x 16-120<br>2 x 16-120  |  | busbar<br>30x6                               | busbar<br>30x6                               | busbar<br>30x6                               | busbar<br>30x5  | busbar<br>40x6                                       | busbar<br>50x8                                | busbar<br>50x8                                | busbar<br>50x10   | busbar<br>50x10  |   |
| -<br>-<br>-   |  |  | -<br>-<br>-                                  |  |   | 10<br>3<br>2   |   |   | 10<br>3<br>2  |  |   |
| 350<br>5<br>0,85 - 1,1  | 350<br>5   | 360<br>5                                     | 360<br>5<br>0,85 - 1,1                       | 360<br>5                                     | 800-950<br>9-11   | 800-950<br>9-11                                      | 1350-1600<br>21-25<br>0,85 - 1,1              | 1350-1600<br>21-25                            | 2400<br>70<br>0,85-1,1  | 2400<br>70   |   |
| base  |  |  |  |  |   |  |   |   |   |  |   |
|  | <b>HKT11 HKT22</b><br>1NO+1NC 2NO+2NC<br>max. 1 pc.  |  |  |  |  | <b>HKF22</b><br>2NO+2NC<br>max. 1 pc.                |   |   |  | <b>HKB11</b><br>1NO+1NC<br>max. 2 pcs.   |   |
|  | <b>HKA11</b><br>1NO+1NC<br>max. 2 pcs.               |  |  |  | -   | -  | -   | -   | -   | -  |   |
|  | <b>U180</b><br><br>1<br>120 - 180A<br><br>integrated |  |  |  |  | <b>U320</b><br><br>2<br>144 - 320A<br><br>integrated |   |   |   |  | <b>U800</b><br><br>3<br>240 - 800A<br><br>SU840/550   SU840/860 |

# Contactors 3-pole

## AC Operated

| Ratings     |           | Rated Current | Aux. Contacts   |   | Type                     | Coil voltage <sup>1)</sup> | Pack pcs. | Weight kg/pc. |
|-------------|-----------|---------------|---|---|--------------------------|----------------------------|-----------|---------------|
| AC2, AC3    |           |               | Built-in  | Additional  |                          |                            |           |               |
| <b>380V</b> |           |               |   | see page 52   |                          | 24V 50/60Hz                |           |               |
| <b>400V</b> | 660V      | AC1           |  |  |                          | 110V 50/60Hz               |           |               |
| <b>415V</b> | 690V      | 690V          |   |   |                          | 220-240V 50Hz              |           |               |
| <b>kW</b>   | <b>kW</b> | <b>A</b>      | <b>NO</b>   | <b>NC</b>   | <b>Typ</b>               | <b>400</b>                 |           |               |
|             |           |               |   |   |                          |                            |           |               |
| <b>4</b>    | 5,5       | 25            | 1   | -   | max. 4                   |                            | 1         | 0,23          |
| <b>4</b>    | 5,5       | 25            | -   | 1   | HN.. or HA..             |                            | 1         | 0,23          |
| <b>5,5</b>  | 7,5       | 25            | 1   | -   |                          |                            | 1         | 0,23          |
| <b>5,5</b>  | 7,5       | 25            | -   | 1   |                          |                            | 1         | 0,23          |
| <b>7,5</b>  | 10        | 32            | 1   | -   |                          |                            | 1         | 0,23          |
| <b>7,5</b>  | 10        | 32            | -   | 1   |                          |                            | 1         | 0,23          |
| <b>11</b>   | 10        | 32            | 1   | -   |                          |                            | 1         | 0,23          |
| <b>11</b>   | 10        | 32            | -   | 1   |                          |                            | 1         | 0,23          |
| <b>11</b>   | 15        | 50            | -   | -   | max. 4                   |                            | 1         | 0,48          |
| <b>15</b>   | 18,5      | 65            | -   | -   | HN.. or HA..             |                            | 1         | 0,48          |
| <b>18,5</b> | 18,5      | 80            | -   | -   | HA.. and 2HB..           |                            | 1         | 0,48          |
| <b>22</b>   | 30        | 110           | -   | -   | max. 4 (3) <sup>4)</sup> |                            | 1         | 0,85          |
| <b>30</b>   | 37        | 120           | -   | -   | HN.. or HA..             |                            | 1         | 0,85          |
| <b>37</b>   | 45        | 130           | -   | -   | HA.. and 2HB..           |                            | 1         | 0,85          |
| <b>45</b>   | 55        | 160           | -   | -   | max. 7                   |                            | 1         | 2,2           |
| <b>55</b>   | 55        | 200           | -   | -   | HN.. or HA.. and 2HB..   |                            | 1         | 2,2           |
| <b>75</b>   | 110       | 250           | -   | -   | 1 HKT..                  |                            | 1         | 4             |
| <b>90</b>   | 132       | 300           | -   | -   | and 2 HKA11              |                            | 1         | 4             |
| <b>110</b>  | 160       | 350           | -   | -   |                          |                            | 1         | 7,2           |
| <b>132</b>  | 210       | 450           | -   | -   |                          |                            | 1         | 7,2           |
| <b>160</b>  | 250       | 600           | -   | -   |                          |                            | 1         | 7,2           |
| <b>250</b>  | 375       | 700           | 2   | 2   | 1 HKF22                  |                            | 1         | 13            |
| <b>300</b>  | 475       | 800           | 2   | 2   |                          |                            | 1         | 13,5          |
| <b>400</b>  | 630       | 1000          | 2   | 2   |                          |                            | 1         | 26,5          |
| <b>500</b>  | 700       | 1100          | 2   | 2   |                          |                            | 1         | 27,6          |
| <b>580</b>  | 850       | 1200          | 1   | 2   | 2 HKB11                  |                            | 1         | 49            |
| <b>680</b>  | 1000      | 1350          | 1   | 2   |                          |                            | 1         | 53            |

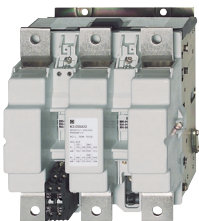

1) Coil voltage range and other coil voltages see page 57

2) Type for AC- and DC-operating: e.g.: 230: 220-240V 50/60Hz and 220V DC (with integrated coil suppressor)

3) Type 230VS for AC-operating 220-240V 50Hz (with integrated coil suppressor)

4) max. 3 HN.. or HA.. for DC-operated Contactors.

# DC Operated

## Type

Coil voltage <sup>1)</sup>  
**24** 24V DC  
**48** 48V DC  
**110** 110V DC  
**220** 110V DC

Coil power

inrush/  
hold

W/W

Additional  
Overload  
Relay  
see  
page 114

Type

Pack  
pcs.

Weight  
kg/pc.

Wiring Diagram

Coil Circuits  
see page 53

Terminal Markings



|                                    |     |                     |   |      |
|------------------------------------|-----|---------------------|---|------|
| <b>KG3-10A10</b> ... <sup>5)</sup> | 3/3 | U3/32               | 1 | 0,53 |
| <b>KG3-10A01</b> ... <sup>5)</sup> | 3/3 | U12/16E<br>U12/16EQ | 1 | 0,53 |
| <b>KG3-14A10</b> ... <sup>5)</sup> | 3/3 | UAT21               | 1 | 0,53 |
| <b>KG3-14A01</b> ... <sup>5)</sup> | 3/3 |                     | 1 | 0,53 |
| <b>KG3-18A10</b> ... <sup>5)</sup> | 3/3 |                     | 1 | 0,53 |
| <b>KG3-18A01</b> ... <sup>5)</sup> | 3/3 |                     | 1 | 0,53 |
| <b>KG3-22A10</b> ... <sup>5)</sup> | 3/3 |                     | 1 | 0,53 |
| <b>KG3-22A01</b> ... <sup>5)</sup> | 3/3 |                     | 1 | 0,53 |

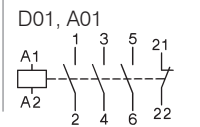
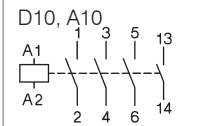

|                                    |     |       |   |      |
|------------------------------------|-----|-------|---|------|
| <b>KG3-24A00</b> ... <sup>5)</sup> | 4/4 | U3/32 | 1 | 0,57 |
| <b>KG3-32A00</b> ... <sup>5)</sup> | 4/4 | U3/42 | 1 | 0,57 |
| <b>KG3-40A00</b> ... <sup>5)</sup> | 4/4 | UAT.. | 1 | 0,57 |

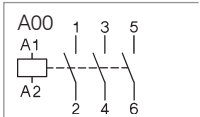

|                      |       |       |   |     |
|----------------------|-------|-------|---|-----|
| <b>K3-50A00=</b> ... | 200/6 | U3/74 | 1 | 0,9 |
| <b>K3-62A00=</b> ... | 200/6 |       | 1 | 0,9 |
| <b>K3-74A00=</b> ... | 200/6 |       | 1 | 0,9 |

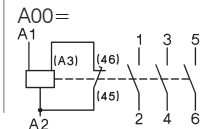

|                                    |       |     |   |     |
|------------------------------------|-------|-----|---|-----|
| <b>K3-90A00</b> ... <sup>2)</sup>  | 280/5 | U85 | 1 | 2,2 |
| <b>K3-115A00</b> ... <sup>2)</sup> | 280/5 |     | 1 | 2,3 |

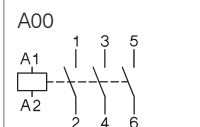

|                                    |       |      |   |   |
|------------------------------------|-------|------|---|---|
| <b>K3-151A00</b> ... <sup>2)</sup> | 350/5 | U180 | 1 | 4 |
| <b>K3-176A00</b> ... <sup>2)</sup> | 350/5 |      | 1 | 4 |

|                                    |       |      |   |     |
|------------------------------------|-------|------|---|-----|
| <b>K3-210A00</b> ... <sup>2)</sup> | 360/5 | U320 | 1 | 7,2 |
| <b>K3-260A00</b> ... <sup>2)</sup> | 360/5 |      | 1 | 7,2 |
| <b>K3-316A00</b> ... <sup>2)</sup> | 360/5 |      | 1 | 7,2 |

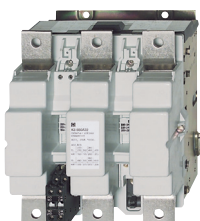

|                                    |        |            |   |      |
|------------------------------------|--------|------------|---|------|
| <b>K3-450A22</b> ... <sup>2)</sup> | 800/10 | U800       | 1 | 13   |
| <b>K3-550A22</b> ... <sup>2)</sup> | 800/10 | +SU840/550 | 1 | 13,5 |

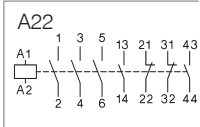

|                                    |         |            |   |      |
|------------------------------------|---------|------------|---|------|
| <b>K3-700A22</b> ... <sup>2)</sup> | 1500/20 | U800       | 1 | 26,5 |
| <b>K3-860A22</b> ... <sup>2)</sup> | 1500/20 | +SU840/860 | 1 | 27,6 |

|                        |         |  |   |    |
|------------------------|---------|--|---|----|
| <b>K3-1000A12=</b> ... | 2100/60 |  | 1 | 49 |
| <b>K3-1200A12=</b> ... | 2100/60 |  | 1 | 53 |

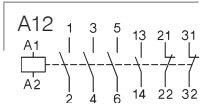

1) Other coil voltages on request

2) Type for AC- and DC-operating: e.g.: 24: 24V 50/60Hz and 24V DC (with integrated coil suppressor)

5) with integrated coil suppressor



## Contactors 3-pole

DC Operated with double winding coil



| Ratings<br>AC2<br>AC3<br><b>380V</b><br><b>400V</b><br><b>415V</b><br><b>kW</b> | Rated<br>Current<br>AC1<br>660V<br>690V<br>kW | Aux. Contacts<br>Built-in<br>Additional<br>see<br>page 52 | Type                | Coil voltage <sup>1)</sup><br><b>24</b> 24V= DC<br><b>48</b> 48V= DC<br><b>110</b> 110V= DC<br><b>220</b> 220V= DC | Pack<br>pcs. | Weight<br>kg/pc. | Wiring Diagram |
|---|---|---|---------------------|--|--------------|------------------|----------------|
|   |   |   |                     |  |              |                  |                |
| <b>4</b>  | 5,5   | 25  | 1 - max. 3          | <b>K3-10ND10= ...</b>  | 1            | 0,25             |                |
| <b>4</b>  | 5,5   | 25  | - 1 HN..            | <b>K3-10ND01= ...</b>  | 1            | 0,25             |                |
| <b>5,5</b>  | 7,5   | 25  | 1 - HA..            | <b>K3-14ND10= ...</b>  | 1            | 0,25             |                |
| <b>5,5</b>  | 7,5   | 25  | - 1                 | <b>K3-14ND01= ...</b>  | 1            | 0,25             |                |
| <b>7,5</b>  | 10  | 32  | 1 -                 | <b>K3-18ND10= ...</b>  | 1            | 0,25             |                |
| <b>7,5</b>  | 10  | 32  | - 1                 | <b>K3-18ND01= ...</b>  | 1            | 0,25             |                |
| <b>11</b>   | 10  | 32  | 1 -                 | <b>K3-22ND10= ...</b>  | 1            | 0,25             |                |
| <b>11</b>   | 10  | 32  | - 1                 | <b>K3-22ND01= ...</b>  | 1            | 0,25             |                |
| <b>11</b>   | 15  | 50  | - - max. 4          | <b>K3-24A00= ...</b>   | 1            | 0,55             |                |
| <b>15</b>   | 18,5  | 65  | - - HN.. or         | <b>K3-32A00= ...</b>   | 1            | 0,55             |                |
| <b>18,5</b>   | 18,5  | 80  | - - HA..<br>+ 2HB.. | <b>K3-40A00= ...</b>   | 1            | 0,55             |                |

## Contactors 4-pole

AC or DC Operated



| Ratings<br>AC2<br>AC3<br><b>380V</b><br><b>400V</b><br><b>415V</b><br><b>kW</b> | Rated<br>Current<br>AC1<br>400V<br>690V<br>kW | Aux. Contacts<br>Built-in<br>Additional<br>see<br>page 52 | Type                     | Coil voltage <sup>2)</sup><br><b>24</b> 24V 50/60Hz<br><b>110</b> 110V 50/60Hz<br><b>230</b> 220-240V 50Hz<br><b>400</b> 380-415V 50Hz<br><b>= 24</b> 24V= DC <sup>3)</sup> | Pack<br>pcs. | Weight<br>kg/pc. | Wiring Diagram |
|---|---|---|--------------------------|---|--------------|------------------|----------------|
|   |   |   |                          |   |              |                  |                |
| <b>4</b>  | <b>17,5</b>                                   | 25  | - - max. 4 <sup>3)</sup> | <b>K3-10NA00-40 ...<sup>3)</sup></b>  | 1            | 0,23             |                |
| <b>4</b>  | <b>17,5</b>                                   | 25  | - - HN.. or              | <b>K3-10NA00-22 ...<sup>3)</sup></b>  | 1            | 0,23             |                |
| <b>4</b>  | <b>17,5</b>                                   | 25  | - - HA..                 | <b>K3-10NA00-04 ...<sup>3)</sup></b>  | 1            | 0,23             |                |
| <b>5,5</b>  | <b>17,5</b>                                   | 25  | - -                      | <b>K3-14NA00-40 ...<sup>3)</sup></b>  | 1            | 0,23             |                |
| <b>5,5</b>  | <b>17,5</b>                                   | 25  | - -                      | <b>K3-14NA00-22 ...<sup>3)</sup></b>  | 1            | 0,23             |                |
| <b>5,5</b>  | <b>17,5</b>                                   | 25  | - -                      | <b>K3-14NA00-04 ...<sup>3)</sup></b>  | 1            | 0,23             |                |
| <b>7,5</b>  | <b>22</b>                                     | 32  | - -                      | <b>K3-18NA00-40 ...<sup>3)</sup></b>  | 1            | 0,23             |                |
| <b>7,5</b>  | <b>22</b>                                     | 32  | - -                      | <b>K3-18NA00-22 ...<sup>3)</sup></b>  | 1            | 0,23             |                |
| <b>7,5</b>  | <b>22</b>                                     | 32  | - -                      | <b>K3-18NA00-04 ...<sup>3)</sup></b>  | 1            | 0,23             |                |
| <b>11</b>   | <b>22</b>                                     | 32  | - -                      | <b>K3-22NA00-40 ...<sup>3)</sup></b>  | 1            | 0,23             |                |
| <b>11</b>   | <b>31</b>                                     | 45  | - - max. 4               | <b>K2-23A00-40 ...<sup>3)</sup></b>   | 1            | 0,65             |                |
| <b>15</b>   | <b>34,5</b>                                   | 50  | - - HN..                 | <b>K2-30A00-40 ...<sup>3)</sup></b>   | 1            | 0,65             |                |
| <b>18,5</b>   | <b>34,5</b>                                   | 50  | - - or HA..              | <b>K2-37A00-40 ...<sup>3)</sup></b>   | 1            | 0,65             |                |
| <b>22</b>   | <b>55</b>                                     | 80  | - - max. 6               | <b>K2-45A00-40 ...<sup>3)</sup></b>   | 1            | 1,1              |                |
| <b>30</b>   | <b>69</b>                                     | 100   | - - HN..<br>or HA..      | <b>K2-60A00-40 ...<sup>3)</sup></b>   | 1            | 1,1              |                |
| <b>15</b>   | <b>43</b>                                     | 63  | - - 1HKT..               | <b>K3-41A00-04 ...<sup>3)</sup></b>   | 1            | 1,4              |                |
| <b>15</b>   | <b>43</b>                                     | 63  | - - +                    | <b>K3-41A00-22 ...<sup>3)</sup></b>   | 1            | 1,4              |                |
|   |   |   | 2xHKA11                  |   |              |                  |                |
| <b>30</b>   | <b>85</b>                                     | 125   | - -                      | <b>K3-96A00-04 ...<sup>4)</sup></b>   | 1            | 2,42             |                |
| <b>30</b>   | <b>85</b>                                     | 125   | - -                      | <b>K3-96A00-22 ...<sup>4)</sup></b>   | 1            | 2,42             |                |
| <b>45</b>   | <b>94</b>                                     | 135   | - -                      | <b>K3-96A00-40 ...<sup>4)</sup></b>   | 1            | 2,42             |                |
| <b>55</b>   | <b>139</b>                                    | 200   | - -                      | <b>K3-116A00-40 ...<sup>4)</sup></b>  | 1            | 4,7              |                |
| <b>75</b>   | <b>173</b>                                    | 250   | - -                      | <b>K3-151A00-40 ...<sup>4)</sup></b>  | 1            | 4,7              |                |
| <b>90</b>   | <b>208</b>                                    | 300   | - -                      | <b>K3-176A00-40 ...<sup>4)</sup></b>  | 1            | 4,7              |                |
| <b>110</b>  | <b>242</b>                                    | 350   | - -                      | <b>K3-210A00-40 ...<sup>4)</sup></b>  | 1            | 8                |                |
| <b>132</b>  | <b>310</b>                                    | 450   | - -                      | <b>K3-260A00-40 ...<sup>4)</sup></b>  | 1            | 8                |                |
| <b>160</b>  | <b>415</b>                                    | 600   | - -                      | <b>K3-316A00-40 ...<sup>4)</sup></b>  | 1            | 8                |                |

Latch for Contactors 4-pole see page 54

1) Other coil voltages on request

2) Coil voltage range and non-standard coil voltages see page 57

3) DC Operated with double winding coil, max. 3 additional aux. contacts

4) with integrated coil suppressor (AC/DC coil)

# Capacitor Switching Contactors

for use with reactive or non-reactive capacitor banks



### Rated Operational Power at 50/60Hz

Ambient Temperature

| 50°C        |      | 60°C |      |
|-------------|------|------|------|
| <b>380V</b> | 415V | 660V | 380V |
| <b>400V</b> | 440V | 690V | 400V |
| <b>kVAr</b> | kVAr | kVAr | kVAr |

Aux. Contacts  
Built-in Add.  
NO NC pcs.

### Type

Coil voltage <sup>1)</sup>  
230 220-240V 50Hz  
Pack Weight  
pcs. kg/pc.

|                      |                      |                      |                     |                     |                      |   |   |                 |   |   |      |
|----------------------|----------------------|----------------------|---------------------|---------------------|----------------------|---|---|-----------------|---|---|------|
| 0-12,5               | 0-13                 | 0-20                 | 0-12,5              | 0-13                | 0-20                 | 1 | - | 1 <sup>2)</sup> | <b>K3-18NK10</b> ...                    | 1 | 0,34 |
| 0-12,5               | 0-13                 | 0-20                 | 0-12,5              | 0-13                | 0-20                 | - | - | 1 <sup>2)</sup> | <b>K3-18NK01</b> ...                    | 1 | 0,34 |
| 0-12,5               | 0-13                 | 0-20                 | 0-12,5              | 0-13                | 0-20                 | 1 | - | 1 <sup>2)</sup> | <b>K3-18NBK10</b> ...                   | 1 | 0,40 |
| 0-12,5               | 0-13                 | 0-20                 | 0-12,5              | 0-13                | 0-20                 | - | - | 1 <sup>2)</sup> | <b>K3-18NBK01</b> ...                   | 1 | 0,40 |
| 10-20                | 10,5-22              | 17-33                | 10-20               | 10,5-22             | 17-33                | - | - | 3 <sup>3)</sup> | <b>K3-24K00</b> ...                     | 1 | 0,62 |
| 10-25                | 10,5-27              | 17-41                | 10-25               | 10,5-27             | 17-41                | - | - | 3 <sup>3)</sup> | <b>K3-32K00</b> ...                     | 1 | 0,62 |
| 20-33,3              | 23-36                | 36-55                | 20-33,3             | 23-36               | 36-55                | - | - | 3 <sup>3)</sup> | <b>K3-50K00</b> ...                     | 1 | 1,0  |
| 20-50                | 23-53                | 36-82                | 20-50               | 23-53               | 36-82                | - | - | 3 <sup>3)</sup> | <b>K3-62K00</b> ...                     | 1 | 1,0  |
| 20-75 <sup>4)</sup>  | 23-75 <sup>4)</sup>  | 36-120 <sup>4)</sup> | 20-60               | 23-64               | 36-100               | - | - | 3 <sup>3)</sup> | <b>K3-74K00</b> ...                     | 1 | 1,0  |
| 33-80                | 36-82                | 57-120               | 33-75               | 36-77               | 57-120               | - | - | 6 <sup>5)</sup> | <b>K3-90K00</b> ... / VS <sup>7)</sup>  | 1 | 2,3  |
| 33-100 <sup>6)</sup> | 36-103 <sup>6)</sup> | 57-148 <sup>6)</sup> | 33-90 <sup>6)</sup> | 36-93 <sup>6)</sup> | 57-148 <sup>6)</sup> | - | - | 6 <sup>5)</sup> | <b>K3-115K00</b> ... / VS <sup>7)</sup> | 1 | 2,3  |

**Specification:** Contactors K3-..K are suitable for switching low-inductive and low loss capacitors in capacitor banks (IEC70 and 831, VDE 0560) without and with reactors.

Capacitor switching contactors are fitted with early make contacts and damping resistors, to reduce the value of make current <70 x I<sub>e</sub>.

**Operating Conditions:** Capacitor switching contactors are protected against contact welding for a prospective making current of 200 x I<sub>e</sub>.

## Technical Data acc. to IEC 947-4-1, IEC 947-5-1, EN 60947-4-1, EN 60947-5-1, VDE 0660

| Type  |   | K3-18NK     | K3-18NBK <sup>8)</sup> | K3-24K       | K3-32K       | K3-50K       | K3-62K       | K3-74K        | K3-90K        | K3-115K       |
|---|---|-------------|------------------------|--------------|--------------|--------------|--------------|---------------|---------------|---------------|
| Max. frequency of operations z                                | 1/h                                     | 120         | 120                    | 120          | 120          | 120          | 120          | 80            | 80            | 80            |
| Contact life non reactive cap. banks                          | S x 10 <sup>3</sup>                     | 250         | 250                    | 150          | 150          | 150          | 150          | 120           | 120           | 120           |
|   | reactive cap. banks S x 10 <sup>3</sup> | 400         | 400                    | 300          | 300          | 300          | 300          | 200           | 200           | 200           |
| <b>Rated operational current I<sub>e</sub></b><br><b>AC6b</b> | at 50°C A                               | <b>0-18</b> | <b>0-18</b>            | <b>14-28</b> | <b>14-36</b> | <b>30-48</b> | <b>30-72</b> | <b>30-108</b> | <b>50-115</b> | <b>50-144</b> |
|   | at 60°C A                               | <b>0-18</b> | <b>0-18</b>            | <b>14-28</b> | <b>14-36</b> | <b>30-48</b> | <b>30-72</b> | <b>30-87</b>  | <b>50-108</b> | <b>50-130</b> |
| Rated operational current I <sub>th</sub><br>AC1              | at 50°C A                               | 32          | 45                     | 45           | 60           | 100          | 110          | 120           | 155           | 190           |
|   | at 60°C A                               | 32          | 40                     | 40           | 55           | 90           | 100          | 110           | 145           | 170           |
| Overload factor<br>acc. to EN 61921: 30% min.                 | at 50°C %                               | 78          | 150                    | 60           | 67           | 108          | 53           | 11            | 35            | 32            |
|   | at 60°C %                               | 78          | 122                    | 43           | 53           | 88           | 39           | 26            | 34            | 31            |
| Fuses gL (gG)   | from / to A                             | 35 / 63     | 35 / 63                | 50 / 80      | 63 / 100     | 80 / 160     | 125 / 160    | 160/200       | 160/200       | 160/250       |

### Typical Circuit Diagram

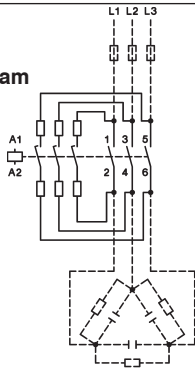

### Wiring Diagram for Quick Discharge Resistors

Make sure that the current of the discharge resistors is not higher than the rated current (AC1) of the auxiliary contacts

### Mounting instructions:

In the area of capacitor switching contactors, difficulty inflammable and self-extinguishing materials shall be used only, because abnormal temperatures within the area of the resistor spirals cannot be excluded.

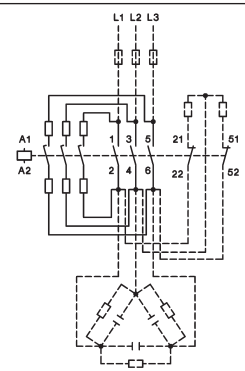

- 1) Coil voltage range and non-standard coil voltages see page 57
- 2) 1 HN.. or HA.. snap-on
- 3) 2HB.. for side mounting and 1 HN.. or HA.. snap-on
- 4) Consider the max. thermal current of the contactor K3-74A: I<sub>th</sub> 130A
- 5) 2 HB.. on the left or right side and 4 HN.. or HA.. snap-on
- 6) Consider the min. cross-section of conductor at max. load
- 7) Type 230 for AC- and DC-operating 220-240V 50/60Hz and 220V DC (with integrated coil suppressor)  
Type 230VS for AC-operating 220-240V 50Hz (with integrated coil suppressor)
- 8) Cable cross sections: 2,5 - 16mm<sup>2</sup>

## Auxiliary Contact Blocks for contactors K(G)3-07.. to K3-115.., type HN.. for low level switching <sup>1)</sup>



| Rated Operational Current |                   |                  | Contacts |    |    |    | Type         | Pack pcs. | Weight kg/pc. |
|---------------------------|-------------------|------------------|----------|----|----|----|--------------|-----------|---------------|
| AC15<br>230V<br>A         | AC15<br>400V<br>A | AC1<br>690V<br>A | NO       | NC | EM | LB |              |           |               |
| 3                         | 2                 | 10               | 1        | -  | -  | -  | <b>HN10</b>  | 10        | 0,02          |
| 3                         | 2                 | 10               | -        | 1  | -  | -  | <b>HN01</b>  | 10        | 0,02          |
| 3                         | 2                 | 10               | -        | -  | 1  | -  | <b>HN10U</b> | 10        | 0,02          |
| 3                         | 2                 | 10               | -        | -  | -  | 1  | <b>HN01U</b> | 10        | 0,02          |
| 6                         | 3                 | 25               | 1        | -  | -  | -  | <b>HA10</b>  | 10        | 0,03          |
| 6                         | 3                 | 25               | -        | 1  | -  | -  | <b>HA01</b>  | 10        | 0,03          |

## Auxiliary Contact Block for contactors K3-24.. to K3-115.., for low level switching <sup>1)</sup>



| Rated Operational Current |                   |                  | mounting:<br>1 HB.. on left side<br>and 1 HB.. on right side | Contacts |    | Type        | Pack pcs. | Weight kg/pc. |
|---------------------------|-------------------|------------------|--|----------|----|-------------|-----------|---------------|
| AC15<br>230V<br>A         | AC15<br>400V<br>A | AC1<br>690V<br>A |  | NO       | NC |             |           |               |
| 3                         | 2                 | 10               |  | 1        | 1  | <b>HB11</b> | 10        | 0,02          |
| 3                         | 2                 | 10               |  | -        | 2  | <b>HB02</b> | 10        | 0,02          |

## Auxiliary Contact Blocks for contactors K3-116.. to K3-1200.., for low level switching <sup>1)</sup>



| Rated Operational Current |                   |                  | For contactors                 | Contacts        |    | Type         | Pack pcs. | Weight kg/pc. |
|---------------------------|-------------------|------------------|--------------------------------|-----------------|----|--------------|-----------|---------------|
| AC15<br>230V<br>A         | AC15<br>400V<br>A | AC1<br>690V<br>A |                                | NO              | NC |              |           |               |
| 3                         | 2                 | 10               | K3-116 to K3-316 top           | 1               | 1  | <b>HKT11</b> | 1         | 0,04          |
| 3                         | 2                 | 10               | K3-116 to K3-316 top           | 2               | 2  | <b>HKT22</b> | 1         | 0,05          |
| 3                         | 2                 | 10               | K3-116 to K3-316 outside       | 1               | 1  | <b>HKA11</b> | 1         | 0,05          |
| 6                         | 3                 | 16               | K3-200 to K3-860 <sup>2)</sup> | 2 <sup>2)</sup> | 2  | <b>HKF22</b> | 1         | 0,12          |
| 6                         | 3                 | 16               | K3-1000, K3-1200 inside        | 1               | 1  | <b>HKB11</b> | 1         | 0,17          |

## Snap-on Momentary Contacts for K(G)3-07.. to K3-115.. for low level switching <sup>1)</sup>



| Rated Operational Current |                   |                  | Specification   | Contacts |    | Type         | Pack pcs. | Weight kg/pc. |
|---------------------------|-------------------|------------------|-----------------|----------|----|--------------|-----------|---------------|
| AC15<br>230V<br>A         | AC15<br>400V<br>A | AC1<br>690V<br>A |                 | NO       | NC |              |           |               |
| 3                         | 2                 | 10               | manual operated | 1        | -  | <b>HTN10</b> | 10        | 0,02          |
| 3                         | 2                 | 10               | manual operated | -        | 1  | <b>HTN01</b> | 10        | 0,02          |

## Terminal Blocks for contactors K(G)3-07.. to K3-115.. and K2-..



| Specification              | Thermal Current I <sub>th</sub><br>A | Type         | Pack pcs. | Weight kg/pc. |
|----------------------------|--------------------------------------|--------------|-----------|---------------|
| 2 terminals interconnected | 26                                   | <b>K2-DK</b> | 10        | 0,02          |
| 2 terminals insulated      | 26                                   | <b>K2-SK</b> | 10        | 0,02          |

1) Contacts suitable for electronic circuits, according to IEC60947-5-4 for rated voltage 24V DC (test ratings 17V DC, 5mA) Mirror contacts acc. IEC60947-4-1 Annex F. Technical data see page 80

2) Contact travel of make contacts adjustable, see page 81

# Electronic Timer

for mounting on DIN-rail, Control voltage 24-240V AC/DC, 1 changeover contact  
 OFF-delay without auxiliary voltage  
 Replace Pneumatic Timer K2-TP. and K2-TA



| 5 Functions in one device   | 4 Time ranges in one device s                | Rated Current AC1 250V A | Type               | Pack pcs. | Weight kg/pc. |
|---|--|--------------------------|--------------------|-----------|---------------|
| ON-delay,<br>OFF-delay,<br>Single shot trailing edge,<br>Single shot leading edge,<br>Single shot leading and trailing edge | 0,1 - 1,<br>1 - 10,<br>6 - 60 a,<br>18 - 180 | 5                        | <b>K3-T180 240</b> | 1         | 0,085         |

## Electronic Timer On-delay for contactors K(G)3-07.. to K3-115.. and K2-..

Timer will be connected with the contactor coil, can be snapped onto the contactor and occupies 2 add-on spaces. Contactor switches On-delay.



| Operational Voltage V | Time Range s | Rated Current AC15 A | Type                | Pack pcs. | Weight kg/pc. |
|-----------------------|--------------|----------------------|---------------------|-----------|---------------|
| 24 - 60V AC/DC        | 1 - 30       | 0,75                 | <b>K2-TE30 60</b>   | 1         | 0,08          |
| 100 - 250V AC/DC      | 1 - 30       | 0,75                 | <b>K2-TE30 250</b>  | 1         | 0,08          |
| 24 - 60V AC/DC        | 10 - 180     | 0,75                 | <b>K2-TE180 60</b>  | 1         | 0,08          |
| 100 - 250V AC/DC      | 10 - 180     | 0,75                 | <b>K2-TE180 250</b> | 1         | 0,08          |
| 24 - 60V AC/DC        | 30 - 600     | 0,75                 | <b>K2-TE600 60</b>  | 1         | 0,08          |
| 100 - 250V AC/DC      | 30 - 600     | 0,75                 | <b>K2-TE600 250</b> | 1         | 0,08          |

### Wiring Diagram

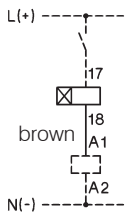

### Timing Chart

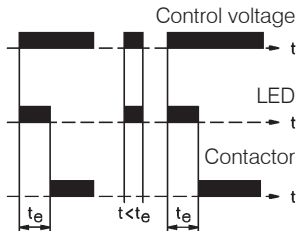

### Operation Range

Time repeat accuracy  
 Recovery time (typical)

$0,8 - 1,1 \times U_s$   
 $\leq 1\%$   
 50ms

**Voltage Drop** after the time delay  $t_e$   
 (Control voltage 24V: use contactor with 20V-coil)  
 Max. inrush current (peak value)

<3V  
 25A <10ms

### Duty Cycle

Ambient temperature  
 Short circuit protection

100%  
 $-40^\circ - +60^\circ\text{C}$   
 2A

## Interface for contactors K3-07.. to K3-74.. and K2-07.. to K2-60..



| Input Voltage $U_e$ | Power Consumption | Rated Current $I_e$ | AC15<br>250V AC | 400V AC | Type         | Pack pcs. | Weight kg/pc. |
|---------------------|-------------------|---------------------|-----------------|---------|--------------|-----------|---------------|
| 24V DC              | 0,35W             | 0,75A               | 0,5A            |         | <b>K2-IM</b> | 1         | 0,03          |

Amplifier element for contactor control by programmable controller

## Fuse Holders for contactors K(G)3-07.. to K3-115.. and K2-..



| Specifications   | Rated Voltage | Type        | Pack pcs. | Weight kg/pc. |
|--|---------------|-------------|-----------|---------------|
| Fuse holder for fuse 5x20mm (max. 6,3A)<br>Fuses are not included. | 250V AC       | <b>K2-F</b> | 1         | 0,02          |

## Rectifier with Fuse Holder for contactors K(G)3-07.. to K3-115.. and K2-..

| Specifications             | Rated Voltage | Type          | Pack pcs. | Weight kg/pc. |
|----------------------------|---------------|---------------|-----------|---------------|
| with built-in rectifier 1A | 250V AC       | <b>K2-RF1</b> | 1         | 0,03          |
| with built-in rectifier 3A | 250V AC       | <b>K2-RF3</b> | 1         | 0,03          |

## Latch for contactors K(G)3-07.. to K3-74.. and K2-..

with NC aux. contact  
duty cycle 10%, max. 30 sec. AC / max. 20 sec. DC  
power consumption max. 35VA

| Type       | Coil voltage      |
|------------|-------------------|
| <b>24</b>  | 22-26V 50/60Hz    |
| <b>110</b> | 100-120V 50/60Hz  |
| <b>230</b> | 210 -250V 50/60Hz |
| <b>400</b> | 360-440V 50/60Hz  |

For Contactors

| For Contactors                                   | Type                | Pack pcs. | Weight kg/pc. |
|--|---------------------|-----------|---------------|
| K3-07 to K3-22, K2-07 to K2-16                   | <b>K2-L22 . . .</b> | 1         | 0,08          |
| K3-24 to K3-40, K2-23 to K2-37, KG3-10 to KG3-40 | <b>K2-L40 . . .</b> | 1         | 0,08          |
| K3-50 to K3-74, K2-45 to K2-60                   | <b>K2-L74 . . .</b> | 1         | 0,08          |

Technical data see page 74

**Latch / Magnetic latch for Contactors K3-151 to K3-1200 on request**

## Indicator Units for contactors K(G)3-07.. to K3-115.. and K2-..



| Specifications   | Voltage Range    | Type          | Pack pcs. | Weight kg/pc. |
|--|------------------|---------------|-----------|---------------|
| <b>Coil Current Indicator</b> , green (LED)  | 24 - 660V AC/DC  | <b>K2-ING</b> | 10        | 0,02          |
| <b>Coil Current Indicator</b> , red (LED)  | 24 - 660V AC/DC  | <b>K2-INR</b> | 10        | 0,02          |
| To connect in series with the contactor coil. In case of coil interruption the indication goes out. Voltage drop appr. 2 volts |                  |               |           |               |
| <b>Voltage Indicator</b> , clear (glow-disc. I.)   | 220 - 415V AC/DC | <b>K2-UN</b>  | 10        | 0,02          |
| <b>Voltage Indicator</b> , red (LED)   | 24 - 120V AC/DC  | <b>K2-UNR</b> | 10        | 0,02          |
| To connect parallel to the contactor coil. In case of applied voltage the indication also lights at coil interruption.         |                  |               |           |               |

## Snap-On Adapter



| For Type   | Specification  | Type         | Pack pcs. | Weight kg/pc. |
|--|--|--------------|-----------|---------------|
| K2-DK, K2-SK, K2-TE, K2-TA<br>K2-IM, K2-F, K2-RF<br>K2-IN., K2-UN. | for snap-on mounting of accessories on 35mm DIN-rail acc. DIN EN 50022 | <b>K2-SM</b> | 10        | 0,009         |

## Additional 4<sup>th</sup> Poles for contactors K3-315.. to K3-1200



| For Contactors         | Thermal Current $I_{th}$<br>A | Type          | Pack pcs. | Weight kg/pc. |
|------------------------|-------------------------------|---------------|-----------|---------------|
| K3-315, K3-450, K3-550 | <b>325</b>                    | <b>NP325</b>  | 1         | 0,7           |
| K3-315, K3-450, K3-550 | <b>500</b>                    | <b>NP500</b>  | 1         | 1,3           |
| K3-450, K3-550         | <b>760</b>                    | <b>NP760</b>  | 1         | 1,4           |
| K3-700, K3-860         | <b>500</b>                    | <b>NP501</b>  | 1         | 1,3           |
| K3-700, K3-860         | <b>1000</b>                   | <b>NP1000</b> | 1         | 1,6           |
| K3-1000, K3-1200       | <b>1000</b>                   | <b>NP1001</b> | 1         | 1,6           |

## Mechanical Interlocks



| Interlocks contactor with contactor Type                                 | Type   | Mounting   | Type                         | Pack pcs. | Weight kg/pc. |
|--|--|------------|------------------------------|-----------|---------------|
| K3-07 to K3-40<br>KG3-07 to KG3-22<br>KG3-24 to KG3-40<br>K2-07 to K2-37 | K3-07 to K3-40<br>KG3-07 to KG3-22<br>KG3-24 to KG3-40<br>K2-07 to K2-37 | horizontal | <b>LG10889</b> <sup>1)</sup> | 10        | 0,006         |
| K3-24 to K3-74<br>K2-23 to K2-60   | K3-50 to K3-74<br>K2-45 to K2-60   | horizontal | <b>LG10890</b> <sup>1)</sup> | 1         | 0,010         |
| K3-90, K3-115  | K3-90, K3-115  | horizontal | <b>LG11478</b> <sup>1)</sup> | 1         | 0,010         |
| K65 to K110  | K65 to K110  | horizontal | <b>LG8511</b>                | 1         | 0,076         |
| K3-116 to K3-316   | K3-116 to K3-316   | horizontal | <b>LG11223H</b>              | 1         | 0,06          |
| K3-315 to K3-550   | K3-315 to K3-550   | horizontal | <b>LG10400H</b>              | 1         | 0,8           |
| K3-315 to K3-550   | K3-315 to K3-550   | vertical   | <b>LG10400V</b>              | 1         | 0,8           |
| K3-450, K3-550   | K3-700, K3-860   | horizontal | <b>LG10399H</b>              | 1         | 1,6           |
| K3-450, K3-550   | K3-700, K3-860   | vertical   | <b>LG10399V</b>              | 1         | 0,9           |
| K3-700, K3-860   | K3-700, K3-860   | horizontal | <b>LG10402H</b>              | 1         | 1,5           |
| K3-700, K3-860   | K3-700, K3-860   | vertical   | <b>LG10402V</b>              | 1         | 0,9           |
| K3-700, K3-860   | K3-1000, K3-1200   | horizontal | <b>LG10401H</b>              | 1         | 1,9           |
| K3-700, K3-860   | K3-1000, K3-1200   | vertical   | <b>LG10401V</b>              | 1         | 1,6           |
| K3-1000, K3-1200   | K3-1000, K3-1200   | horizontal | <b>LG10403H</b>              | 1         | 1,8           |
| K3-1000, K3-1200   | K3-1000, K3-1200   | vertical   | <b>LG10403V</b>              | 1         | 1,5           |

1) clamps for mounting incl.

## Terminal Covers for terminal protection according to DIN 57106, VBG 4



| For Contactors           | Specification          | Type            | Pack pcs. | Weight kg/pc. |
|--------------------------|------------------------|-----------------|-----------|---------------|
| K65 to K110 (spare part) | for 6 terminals        | <b>LG9333</b>   | 1         | 0,045         |
| K3-151, K3-176           | 3-pole for 3 terminals | <b>LG10404</b>  | 1         | 0,12          |
| K3-116 to K3-176         | 4-pole for 4 terminals | <b>LG104044</b> | 1         | 0,14          |
| K3-210, K3-260, K3-316   | for 3 terminals        | <b>LG11457</b>  | 1         | 0,14          |
| K3-200                   | for 3 terminals        | <b>LG10405</b>  | 1         | 0,18          |
| K3-315, K3-450           | for 3 terminals        | <b>LG10406</b>  | 1         | 0,28          |
| K3-550                   | for 3 terminals        | <b>LG10407</b>  | 1         | 0,34          |
| K3-700                   | for 3 terminals        | <b>LG10408</b>  | 1         | 0,39          |
| K3-860                   | for 3 terminals        | <b>LG10409</b>  | 1         | 0,49          |

## Additional Terminals



| For Contactors  | Cable Cross-sections to clamp mm <sup>2</sup><br>solid or<br>stranded | flexible | flex. with multi-<br>core cable end | Type           | Pack pcs. | Weight kg/pc. |
|---|---|----------|-------------------------------------|----------------|-----------|---------------|
| <b>Additional Terminal Single Pole, with fingertouch protection</b> |   |          |                                     |                |           |               |
| K(G)3-10 to K(G)3-22  | 0,75 - 10   | 0,75 - 6 | 0,75 - 6                            | <b>LG9339N</b> | 6         | 0,009         |
| K2-09 to K2-16  |   |          |                                     |                |           |               |
| K3-151 to K3-176  |   | 16 - 120 | + 16 - 95                           | <b>LG11224</b> | 1         | 0,10          |

1) Inclusively mounting clamps

## Parallel Connectors

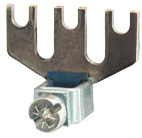

| For Contactors | Cable Cross-sections to clamp mm <sup>2</sup><br>solid or<br>stranded | flexible | flex. with multi-<br>core cable end | Type | Pack<br>pcs. | Weight<br>kg/pc. |
|----------------|---|----------|-------------------------------------|------|--------------|------------------|
|----------------|---|----------|-------------------------------------|------|--------------|------------------|

### Parallel Connectors, 3 Poles Parallel

Current-carrying capacity: 2,5 x AC1-value of the contactor

|                      |                            |        |        |               |    |       |
|----------------------|----------------------------|--------|--------|---------------|----|-------|
| K(G)3-10 to K(G)3-22 | terminal hole for screw M5 |        |        | <b>LG9241</b> | 50 | 0,004 |
| K2-09 to K2-16       |                            |        |        |               |    |       |
| K2-23 to K2-37       | 4 - 35                     | 6 - 25 | 4 - 25 | <b>LG5587</b> | 10 | 0,022 |

### Parallel Connectors, 4 Poles Parallel

Current-carrying capacity: 3,2 x AC1-value of the contactor

|                      |                            |  |  |               |    |       |
|----------------------|----------------------------|--|--|---------------|----|-------|
| K(G)3-10 to K(G)3-22 | terminal hole for screw M5 |  |  | <b>LG7360</b> | 10 | 0,006 |
| K2-09 to K2-16       |                            |  |  |               |    |       |

## Suppressor Units



| Voltage Range<br>V | Mounting |  | Type | Pack<br>pcs. | Weight<br>kg/pc. |
|--------------------|----------|--|------|--------------|------------------|
|--------------------|----------|--|------|--------------|------------------|

### RC-units for contactors K3-07 - K3-74

|                  |           |                  |                   |    |      |
|------------------|-----------|------------------|-------------------|----|------|
| 12 - 48V AC/DC   | to snap   | 1600nF / 22 Ohm  | <b>RC-K3N 24</b>  | 10 | 0,01 |
| 48 - 127V AC/DC  | on the    | 680nF / 270 Ohm  | <b>RC-K3N 110</b> | 10 | 0,01 |
| 110 - 230V AC/DC | contactor | 220nF / 2200 Ohm | <b>RC-K3N 230</b> | 10 | 0,01 |
| 230 - 415V AC/DC |           | 120nF / 620 Ohm  | <b>RC-K3N 400</b> | 10 | 0,01 |

### RC-units for contactors K3-07 - K3-74 and reversing contactors K3NWU10 - K3WU74

|                  |           |                  |                    |    |      |
|------------------|-----------|------------------|--------------------|----|------|
| 12 - 48V AC/DC   | to snap   | 1600nF / 22 Ohm  | <b>RC-K3NW 24</b>  | 10 | 0,01 |
| 48 - 127V AC/DC  | on the    | 680nF / 270 Ohm  | <b>RC-K3NW 110</b> | 10 | 0,01 |
| 110 - 230V AC/DC | contactor | 220nF / 2200 Ohm | <b>RC-K3NW 230</b> | 10 | 0,01 |
| 230 - 415V AC/DC |           | 120nF / 620 Ohm  | <b>RC-K3NW 400</b> | 10 | 0,01 |

## Mounting Parts



| Description | For Type | Specification | Type | Pack<br>pcs. | Weight<br>kg/pc. |
|-------------|----------|---------------|------|--------------|------------------|
|-------------|----------|---------------|------|--------------|------------------|

|                               |                                   |  |               |    |       |
|-------------------------------|-----------------------------------|--|---------------|----|-------|
| <b>Clamp,<br/>no distance</b> | K3-07 to K3-115<br>K2-07 to K2-37 | To join contactors<br>without distance,<br>2 pieces required | <b>P426-1</b> | 50 | 0,001 |
|-------------------------------|-----------------------------------|--|---------------|----|-------|



|                                |                                   |   |               |    |       |
|--------------------------------|-----------------------------------|---|---------------|----|-------|
| <b>Clamp,<br/>7mm distance</b> | K3-07 to K3-115<br>K2-07 to K2-37 | To join contactors<br>with 7mm distance,<br>2 pieces required | <b>P418-1</b> | 10 | 0,002 |
|--------------------------------|-----------------------------------|---|---------------|----|-------|

|                                 |                                   |  |               |    |       |
|---------------------------------|-----------------------------------|--|---------------|----|-------|
| <b>Clamp,<br/>12mm distance</b> | K3-07 to K3-115<br>K2-07 to K2-37 | To join contactors<br>with 12mm distance,<br>2 pieces required | <b>P807-1</b> | 10 | 0,002 |
|---------------------------------|-----------------------------------|--|---------------|----|-------|

|                             |                                       |  |               |    |       |
|-----------------------------|---------------------------------------|--|---------------|----|-------|
| <b>Clamp<br/>asymmetric</b> | K3-07 to K3-40<br>with K3-50 to K3-74 | To join contactors<br>with 12mm distance,<br>2 pieces required | <b>P785-1</b> | 10 | 0,002 |
|-----------------------------|---------------------------------------|--|---------------|----|-------|



|                        |                |                     |             |  |  |
|------------------------|----------------|---------------------|-------------|--|--|
| <b>Retention clamp</b> | K3-10 to K3-74 | To close contactors | <b>P725</b> |  |  |
|------------------------|----------------|---------------------|-------------|--|--|

## Marking System for contactors K3-07.. to K3-115.., K2-.. and aux. contact blocks HN and HA



| Description | Specification | Type | Pack<br>pcs. | Weight<br>kg/100pc |
|-------------|---------------|------|--------------|--------------------|
|-------------|---------------|------|--------------|--------------------|

|                      |                                      |               |     |       |
|----------------------|--------------------------------------|---------------|-----|-------|
| <b>Marking Plate</b> | 2-section without marking, divisible | <b>P487-1</b> | 100 | 0,025 |
|----------------------|--------------------------------------|---------------|-----|-------|

|                      |                                      |               |     |       |
|----------------------|--------------------------------------|---------------|-----|-------|
| <b>Marking Plate</b> | 3-section without marking, divisible | <b>P971-1</b> | 100 | 0,038 |
|----------------------|--------------------------------------|---------------|-----|-------|

|                      |                                      |               |     |       |
|----------------------|--------------------------------------|---------------|-----|-------|
| <b>Marking Plate</b> | 4-section without marking, divisible | <b>P245-1</b> | 100 | 0,050 |
|----------------------|--------------------------------------|---------------|-----|-------|

|                      |                            |                 |     |       |
|----------------------|----------------------------|-----------------|-----|-------|
| <b>Marking Plate</b> | marked, choice of K1...K32 | <b>P245-K..</b> | 100 | 0,013 |
|----------------------|----------------------------|-----------------|-----|-------|



## Coil voltages for AC operated contactors

Type-suffix for coil-types K6/.. to K45/...  
for contactor-types K3-07.. to K3-74

| Suffix to contactor type | to coil type | Voltage Marking at the coil |                       | Rated Control Voltage U <sub>s</sub> range |                   |                 |                   |
|--------------------------|--------------|-----------------------------|-----------------------|--|-------------------|-----------------|-------------------|
|                          |              | for 50Hz V                  | for 60Hz V            | for 50Hz min. V                            | max. V            | for 60Hz min. V | max. V            |
| 6                        | 41.6         | 6                           |                       | 6  | 6,6               | 6,6             | 7,3               |
| 6,6                      | 41.6,6       | 6,6                         |                       | 6,6  | 7,3               | 7,3             | 8                 |
| 7,3                      | 41.7,3       | 7,3                         |                       | 7,3  | 8                 | 8               | 9                 |
| 8                        | 41.8         | 8                           |                       | 8  | 9                 | 9               | 10                |
| 9                        | 41.9         | 9                           |                       | 9  | 10                | 10              | 11                |
| 10                       | 41.10        | 10                          |                       | 10   | 11                | 11              | 12                |
| 11                       | 41.11        | 11                          | 12                    | 11   | 12                | 12              | 13,2              |
| 12                       | 41.12        | 12                          |                       | 12   | 13,2              | 13,2            | 14,5              |
| 13,2                     | 41.13        | 13,2                        |                       | 13,2                                       | 14,5              | 14,5            | 16                |
| 14,5                     | 41.14        | 14,5                        |                       | 14,5                                       | 16                | 16              | 18                |
| 16                       | 41.16        | 16                          |                       | 16   | 18                | 18              | 20                |
| 18                       | 41.18        | 18                          |                       | 18   | 20                | 20              | 22                |
| 20                       | 41.20        | 20                          |                       | 20   | 22                | 22              | 24                |
| <b>24</b>                | <b>4.24</b>  | <b>24</b>                   | <b>24</b>             | <b>22</b>                                  | <b>24</b>         | <b>24</b>       | <b>27</b>         |
| 25                       | 41.25        | 25                          |                       | 24   | 27                | 27              | 30                |
| 27                       | 41.27        | 27                          | 32                    | 27   | 30                | 30              | 33                |
| 32                       | 41.32        | 32                          | 36                    | 30   | 33                | 33              | 36                |
| 33                       | 41.33        | 36                          | 36                    | 33   | 36                | 36              | 39                |
| 36                       | 41.36        | 36                          | 42                    | 36   | 39                | 39              | 42                |
| 40                       | 41.40        | 42                          | 42                    | 39   | 42                | 42              | 47                |
| <b>42</b>                | <b>4.42</b>  | <b>42</b>                   | <b>48</b>             | <b>42</b>                                  | <b>47</b>         | <b>47</b>       | <b>52</b>         |
| 48                       | 41.48        | 48                          | 48                    | 44   | 48                | 48              | 52                |
| 55                       | 41.55        | 55                          | 60                    | 52   | 58                | 58              | 65                |
| 60                       | 41.60        | 60                          |                       | 58   | 65                | 65              | 72                |
| 65                       | 41.65        | 65                          |                       | 65   | 72                | 72              | 80                |
| 75                       | 41.75        | 75                          |                       | 72   | 80                | 80              | 90                |
| 85                       | 41.85        | 85                          |                       | 80   | 90                | 90              | 100               |
| 90                       | 41.90        | 100                         | 100                   | 90   | 100               | 100             | 110               |
| <b>110</b>               | <b>4.110</b> | <b>110</b>                  | <b>110-120</b>        | <b>100</b>                                 | <b>110</b>        | <b>110</b>      | <b>122</b>        |
| 115                      | 41.115       | 115                         | 125                   | 110  | 122               | 122             | 135               |
| 127                      | 41.127       | 127                         |                       | 122  | 135               | 135             | 150               |
| 140                      | 41.140       | 140                         |                       | 135  | 150               | 150             | 165               |
| 150                      | 41.150       | 150                         |                       | 150  | 165               | 165             | 180               |
| 165                      | 41.165       | 165                         | 180-208               | 165  | 180               | 180             | 208               |
| 180                      | 41.180       | 180-210 <sup>1)</sup>       | 200-240 <sup>1)</sup> | 180  | 210 <sup>1)</sup> | 200             | 240 <sup>1)</sup> |
| 190R <sup>2)</sup>       | 41.190       | 200-240                     | 200-240               | 200  | 240               | 200             | 240               |
| 200                      | 41.200       | 200-230 <sup>1)</sup>       | 220-240               | 200  | 230 <sup>1)</sup> | 220             | 240               |
| <b>230</b>               | <b>4.230</b> | <b>220-240</b>              | <b>230-264</b>        | <b>220</b>                                 | <b>240</b>        | <b>230</b>      | <b>264</b>        |
| 254                      | 41.254       | 254                         | 277                   | 240  | 264               | 264             | 290               |
| 270                      | 41.270       | 270                         |                       | 264  | 290               | 290             | 315               |
| 300                      | 41.300       | 300                         |                       | 290  | 315               | 315             | 345               |
| 320                      | 41.320       | 320                         |                       | 315  | 345               | 345             | 380               |
| 345                      | 41.345       | 345-400 <sup>1)</sup>       | 380-440 <sup>1)</sup> | 345  | 400 <sup>1)</sup> | 380             | 440 <sup>1)</sup> |
| 390R <sup>2)</sup>       | 41.390       | 400-480                     | 400-480               | 400  | 480               | 400             | 480               |
| <b>400</b>               | <b>4.400</b> | <b>380-415</b>              | <b>400-440</b>        | <b>380</b>                                 | <b>415</b>        | <b>400</b>      | <b>460</b>        |
| 415                      | 41.415       | 415-440                     | 440-480               | 400  | 440               | 440             | 480               |
| 440                      | 41.440       | 440-480                     | 480-500               | 440  | 480               | 480             | 530               |
| 480                      | 41.480       | 480-500                     | 530-580               | 480  | 530               | 530             | 580               |
| 500                      | 41.500       | 500-550                     | 550-600               | 500  | 550               | 550             | 600               |
| 550                      | 41.550       | 550-600                     | 600                   | 550  | 600               | 600             | (650)             |

### Standard voltages in bold type letters.

- 1) Operating range of magnet-coils: 0,85 x U<sub>s</sub> (min. value of rated control voltage) up to 1,05 x U<sub>s</sub> (max. value of rated control voltage).  
2) Reduction of mechanical life to 10% of normal life. It is not admissible as a spare coil in a contactor for different coil voltages.

Type-suffix for coil-types K85/... and K110/...  
for contactor-types K85 to K110

| Suffix to contactor type | to coil type | Voltage Marking at the coil |            | Rated Control Voltage U <sub>s</sub> range |            |                 |            |
|--------------------------|--------------|-----------------------------|------------|--|------------|-----------------|------------|
|                          |              | for 50Hz V                  | for 60Hz V | for 50Hz min. V                            | max. V     | for 60Hz min. V | max. V     |
| 20                       | 4.20         | 20                          | 24         | 20   | 22         | 24              | 26         |
| 24                       | 4.24         | 24                          |            | 24   | 27         | 29              | 32         |
| 42                       | 4.42         | 42                          |            | 42   | 47         | 50              | 56         |
| 110                      | 4.110        | 110-120                     |            | 110  | 122        | 132             | 146        |
| <b>230</b>               | <b>4.230</b> | <b>220-240</b>              | <b>277</b> | <b>220</b>                                 | <b>240</b> | <b>264</b>      | <b>288</b> |
| 400                      | 4.400        | 380-415                     | 460-480    | 380  | 415        | 455             | 498        |

Type-suffix for coil-types K3-1200/...  
for contactor-types K3-1000.. to K3-1200..

|            |              |                |   |            |            |            |            |
|------------|--------------|----------------|---|------------|------------|------------|------------|
| 110        | 4.110        | 110-115        | - | 110        | 115        | 110        | 115        |
| <b>230</b> | <b>4.230</b> | <b>220-230</b> | - | <b>220</b> | <b>230</b> | <b>220</b> | <b>230</b> |
| <b>400</b> | <b>4.400</b> | <b>380-400</b> | - | <b>380</b> | <b>400</b> | <b>380</b> | <b>400</b> |
| 440        | 4.440        | 440            | - | 440        | 440        | 440        | 440        |

## Coil voltages for AC and DC operated contactors

Type-suffix for coil-types K3-115/.. to K3-860/...  
for contactor-types K3-90.. to K3-860..

| Suffix to contactor type | to coil type | Voltage Marking at the coil |            | Rated Control Voltage U <sub>s</sub> range |            |                 |            |
|--------------------------|--------------|-----------------------------|------------|--|------------|-----------------|------------|
|                          |              | for 50/60Hz V               | for DC V   | for 50Hz min. V                            | max. V     | for 60Hz min. V | max. V     |
| 24                       | 4.24         | 24                          | 24         | 22   | 24         | 22              | 24         |
| 48                       | 4.48         | 48                          | 48         | 44   | 48         | 44              | 48         |
| 110                      | 4.110        | 110-120                     | 110        | 110  | 120        | 110             | 120        |
| <b>230</b>               | <b>4.230</b> | <b>220-240</b>              | <b>220</b> | <b>220</b>                                 | <b>240</b> | <b>220</b>      | <b>240</b> |
| <b>400</b>               | <b>4.400</b> | <b>380-415</b>              | -          | <b>380</b>                                 | <b>415</b> | <b>380</b>      | <b>415</b> |

## Coil voltages for AC operated contactors

Type-suffix for coil-types K3-115/..AC  
for contactor-types K3-90..AC to K3-115..AC

| Suffix to contactor type | to coil type   | Voltage Marking at the coil |            | Rated Control Voltage U <sub>s</sub> range |            |                 |            |
|--------------------------|----------------|-----------------------------|------------|--|------------|-----------------|------------|
|                          |                | for 50Hz V                  | for 60Hz V | for 50Hz min. V                            | max. V     | for 60Hz min. V | max. V     |
| <b>110AC</b>             | <b>4.110AC</b> | 110-122                     | 132-146    | 110  | 122        | 132             | 146        |
| <b>230AC</b>             | <b>4.230AC</b> | <b>220-240</b>              | <b>277</b> | <b>220</b>                                 | <b>240</b> | <b>264</b>      | <b>288</b> |

Other coil voltages on request

**Operating range of magnet-coils: 0,85 x U<sub>s</sub> (min. value of rated control voltage) up to 1,1 x U<sub>s</sub> (max. value of rated control voltage)**

With reduced control voltage range 0,9 up to 1,0 x U<sub>s</sub> at ambient temperature 60 - 90°C



## Spare Coils for AC operated contactors



|   |                                    | Type                | Coil voltage <sup>1)</sup> | Pack pcs. | Weight kg/pc. |
|---|------------------------------------|---------------------|----------------------------|-----------|---------------|
| For Contactors                          |                                    | <b>4.24</b>         | 24V 50Hz                   |           |               |
|   |                                    | <b>4.42</b>         | 42V 50Hz                   |           |               |
|   |                                    | <b>4.110</b>        | 110V 50Hz                  |           |               |
|   |                                    | <b>41.180</b>       | 180V 50Hz, 220V 60Hz       |           |               |
|   |                                    | <b>4.230</b>        | 220-240V 50Hz              |           |               |
|   |                                    | <b>4.400</b>        | 380-415V 50Hz              |           |               |
|   |                                    | ↓                   |                            |           |               |
| K3-07N.. up to K3-22N..                 |                                    | <b>K10N/ ...EUR</b> |                            | 1         | 0,053         |
| K3-07.. up to K3-22..                   |                                    | <b>K3-6/ ...</b>    |                            | 10        | 0,040         |
| K2-07.. up to K2-16..                   |                                    | <b>K6/ ...</b>      |                            | 10        | 0,040         |
| K3-24.. up to K3-40..                   |                                    | <b>K24/ ...</b>     |                            | 1         | 0,085         |
| K2-23.. up to K2-37..                   |                                    | <b>K23/ ...</b>     |                            | 1         | 0,085         |
| K3-50.. up to K3-74.., K2-45.., K2-60.. |                                    | <b>K45/ ...</b>     |                            | 1         | 0,110         |
| K65.., K85..                            |                                    | <b>K85/ ...</b>     |                            | 1         | 0,215         |
| K110..                                  |                                    | <b>K110/ ...</b>    |                            | 1         | 0,220         |
| For Contactors                          |                                    | Type                | Coil voltage <sup>1)</sup> | pcs.      | kg/pc.        |
|   |                                    | <b>4.110</b>        | 110V 50Hz, 110-115V 60Hz   |           |               |
|   |                                    | <b>4.230</b>        | 220-230V 50Hz              |           |               |
|   |                                    | <b>4.400</b>        | 380-400V 50Hz              |           |               |
|   |                                    | ↓                   |                            |           |               |
| K3-150.., K3-175..                      |                                    | <b>K3-175/ ...</b>  |                            | 1         | 0,38          |
| K3-1000.., K3-1200..                    | without feeder group <sup>2)</sup> | <b>K3-1200/ ...</b> |                            | 1         | 3,12          |

## Spare Coils for AC and DC operated contactors



|                    |                                    | Type               | Coil voltage <sup>1)</sup> | Pack pcs. | Weight kg/pc. |
|--------------------|------------------------------------|--------------------|----------------------------|-----------|---------------|
| For Contactors     |                                    | <b>4.24</b>        | 24V 50/60Hz / 24V DC       |           |               |
|                    |                                    | <b>4.110</b>       | 110-120V 50/60Hz / 110V DC |           |               |
|                    |                                    | <b>4.230</b>       | 220-240V 50/60Hz / 220V DC |           |               |
|                    |                                    | <b>4.400</b>       | 380-415V 50/60Hz           |           |               |
|                    |                                    | ↓                  |                            |           |               |
| K3-90.., K3-115..  | with feeder group                  | <b>K3-115/ ...</b> |                            | 1         | 0,30          |
| K3-151.., K3-176.. | with feeder group                  | <b>K3-176/ ...</b> |                            | 1         | 0,68          |
| K3-210.., K3-316.. | with feeder group                  | <b>K3-316/ ...</b> |                            | 1         | 0,68          |
| K3-450.., K3-550.. | without feeder group <sup>2)</sup> | <b>K3-550/ ...</b> |                            | 1         | 1,63          |
| K3-700.., K3-860.. | without feeder group <sup>2)</sup> | <b>K3-860/ ...</b> |                            | 1         | 2,44          |

## Spare Feeder Groups for contactors K3-450.. to K3-860..

In case of changing control voltage, change coil and feeder group too

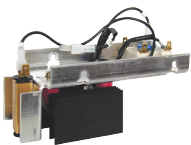

|                    |             | Type                 | Coil voltage <sup>1)</sup> | Pack pcs. | Weight kg/pc. |
|--------------------|-------------|----------------------|----------------------------|-----------|---------------|
| For Contactors     |             | <b>110</b>           | 110-120V 50/60Hz / 110V DC |           |               |
|                    |             | <b>230</b>           | 220-240V 50/60Hz / 220V DC |           |               |
|                    |             | <b>400</b>           | 380-415V 50/60Hz           |           |               |
|                    |             | ↓                    |                            |           |               |
| K3-450.., K3-550.. | K3-550/4... | <b>K3-550/FG ...</b> |                            | 1         | 0,33          |
| K3-700.., K3-860.. | K3-860/4..  | <b>K3-860/FG ...</b> |                            | 1         | 0,54          |

1) Coil voltage range and non-standard coil voltages see page 57

2) In case of changing control voltage, change coil and feeder group too

# Spare Coils for DC operated contactors

Aux. Contact Block for double winding coil

| Type          | Coil voltage <sup>1)</sup> |
|---------------|----------------------------|
| <b>47.24</b>  | 24V DC                     |
| <b>47.48</b>  | 48V DC                     |
| <b>47.110</b> | 110V DC                    |
| <b>47.220</b> | 220V DC                    |

For Contactors

| For Contactors                              | Aux. Contact Block | Type             | Pack pcs. | Weight kg/pc. |
|---|--------------------|------------------|-----------|---------------|
| K3-07N..= up to K3-22N..=                   | HN01U              | <b>K10N/ ...</b> | 1         | 0,052         |
| K3-07..= up to K3-22..=                     | HN01U              | <b>K3-6/ ...</b> | 1         | 0,042         |
| K2-07..= up to K2-16..=                     | HN01U              | <b>K6/ ...</b>   | 1         | 0,042         |
| K3-24..= up to K3-40..=                     | HN01X              | <b>K24/ ...</b>  | 1         | 0,090         |
| K2-23..= up to K2-37..=                     | HN01X              | <b>K23/ ...</b>  | 1         | 0,090         |
| K3-50..= up to K3-74..=, K2-45..=, K2-60..= | HN01Z              | <b>K45/ ...</b>  | 1         | 0,115         |
| K65..=, K85..=                              | -                  | <b>K85/ ...</b>  | 1         | 0,220         |
| K110..=                                     | -                  | <b>K110/ ...</b> | 1         | 0,225         |



| Type          | Coil voltage <sup>1)</sup> |
|---------------|----------------------------|
| <b>43.110</b> | 110V DC                    |
| <b>43.220</b> | 220V DC                    |

For Contactors

| For Contactors         | Aux. Contact Block                 | Type                | Pack pcs. | Weight kg/pc. |
|------------------------|------------------------------------|---------------------|-----------|---------------|
| K3-1000..=, K3-1200..= | without feeder group <sup>2)</sup> | <b>K3-1200/ ...</b> | 1         | 3,12          |

## Wiring Diagrams for Coil Circuit

AC operated,

**K3-07..**  
up to **K110..**



DC operated with double winding coil

**K3-07..=**  
up to **K3-22..=**

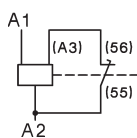

DC operated

**KG3..**

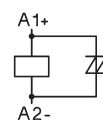

AC and DC operated with double winding coil  
**K3-90A00, K3-115A00**  
**K3-151A00, K3-176A00**  
**K3-210A00 to K3-316A00**

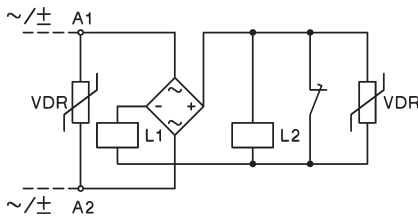

**K3-24..=**  
to  
**K3-74..=**

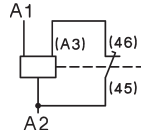

AC and DC operated with series resistor  
**K3-200A21**  
**K3-315A21**

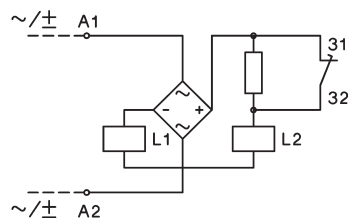

**K85..=**  
**K110..=**

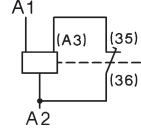

AC and DC operated with series resistor  
**K3-450..** up to **K3-860..**

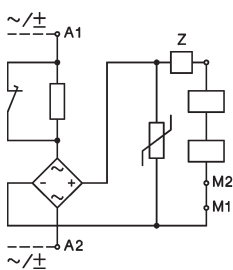

DC operated with DC coil  
**K3-1000.., K3-1200..**

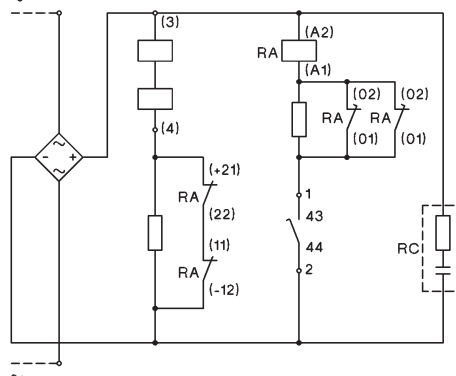

AC operated with DC coil  
**K3-1000.., K3-1200..**

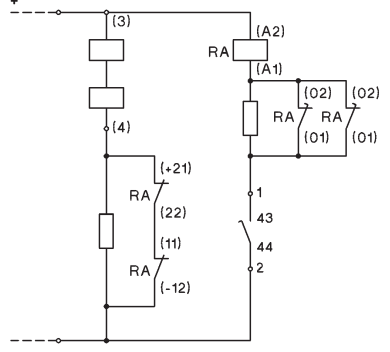

Adjustable dropout operating time for K3-450.. to K3-860..  
150-200ms: Wiring see above (delivery standard)  
500-1000ms: Jumper device "Z"  
approx. 20ms: Special wiring see package folder

Contactors K3-1000.., K3-1200..  
For control voltages up to 125V  
NC contacts 21-22 and 11-12 are connected parallel,  
for higher voltages contacts are connected in series (delivery standard).

1) Other coil voltages on request  
2) In case of changing control voltage, change coil and feeder group too

## Spare Contacts

| <b>Main Contacts</b><br>for Contactors | <b>Type</b>        | Pack<br>pcs. | Weight<br>kg/pc. |
|--|--------------------|--------------|------------------|
| K85..                                  | <b>EK85/1</b>      | 3            | 0,235            |
| K110..                                 | <b>EK110/1</b>     | 3            | 0,275            |
| K3-150..                               | <b>EK3-150/10</b>  | 1            | 0,32             |
| K3-151..                               | <b>EK3-151/10</b>  | 1            | 0,16             |
| K3-175..                               | <b>EK3-175/10</b>  | 1            | 0,32             |
| K3-176..                               | <b>EK3-176/10</b>  | 1            | 0,16             |
| K3-200..                               | <b>EK3-200/10</b>  | 1            | 0,18             |
| K3-210..                               | <b>EK3-210/10</b>  | 1            | 0,18             |
| K3-260..                               | <b>EK3-260/10</b>  | 1            | 0,30             |
| K3-315..                               | <b>EK3-315/10</b>  | 1            | 0,34             |
| K3-316..                               | <b>EK3-316/10</b>  | 1            | 0,34             |
| K3-450..                               | <b>EK3-450/10</b>  | 1            | 0,35             |
| K3-550..                               | <b>EK3-550/10</b>  | 1            | 0,35             |
| K3-700..                               | <b>EK3-700/10</b>  | 1            | 0,85             |
| K3-860..                               | <b>EK3-860/10</b>  | 1            | 1,0              |
| K3-1000..                              | <b>EK3-1000/10</b> | 1            | 1,4              |
| K3-1200..                              | <b>EK3-1200/10</b> | 1            | 1,4              |



# Contactors

## Data according to IEC 947-4-1, EN 60947-4-1, VDE 0660

| Main Contacts  | Type               | K(G)3-10  | K(G)3-14   | K(G)3-18   | K(G)3-22  | K(G)3-24  | K(G)3-32  | K(G)3-40    | K3-50      | K3-62      | K3-74      |
|--|--------------------|-----------|------------|------------|-----------|-----------|-----------|-------------|------------|------------|------------|
| <b>Rated insulation voltage <math>U_i</math></b> <sup>1)</sup>                 | V AC               | 690       | 690        | 690        | 690       | 690       | 690       | 690         | 830        | 830        | 830        |
| <b>Making capacity <math>I_{eff}</math></b> at $U_e = 690V$ AC                 | A                  | 200       | 200        | 200        | 200       | 400       | 500       | 500         | 700        | 900        | 900        |
|  | 1000V AC           | -         | -          | -          | -         | -         | -         | -           | -          | -          | -          |
| <b>Breaking capacity <math>I_{eff}</math></b> 400V AC                          | A                  | 180       | 180        | 200        | 200       | 380       | 400       | 400         | 600        | 800        | 800        |
| K3-10 to K3-22 $\cos\phi = 0,65$   | A                  | 150       | 150        | 180        | 180       | 300       | 370       | 370         | 500        | 700        | 700        |
| K3-24 to K3-1200 $\cos\phi = 0,35$   | A                  | 100       | 100        | 150        | 150       | 260       | 340       | 340         | 400        | 500        | 500        |
|  | 1000V AC           | -         | -          | -          | -         | -         | -         | -           | -          | -          | -          |
| <b>Utilization category AC1</b>  |                    |           |            |            |           |           |           |             |            |            |            |
| <b>Switching of resistive load</b>   |                    |           |            |            |           |           |           |             |            |            |            |
| Rated operational current $I_e (=I_{th})$ at 40°C, open                        | 690V A             | <b>25</b> | <b>25</b>  | <b>32</b>  | <b>32</b> | <b>50</b> | <b>65</b> | <b>80</b>   | <b>110</b> | <b>120</b> | <b>130</b> |
| Rated operational power of three-phase resistive loads 50-60Hz, $\cos\phi = 1$ | 220V kW            | 9,5       | 9,5        | 12,2       | 12,2      | 19,0      | 24,7      | 30,4        | 41,9       | 45,7       | 49,5       |
|  | 230V kW            | 9,9       | 9,9        | 12,7       | 12,7      | 19,9      | 25,9      | 31,8        | 43,8       | 47,7       | 51,7       |
|  | 240V kW            | 10,4      | 10,4       | 13,3       | 13,3      | 20,8      | 27,0      | 33,2        | 45,7       | 49,8       | 54,0       |
|  | 380V kW            | 16,4      | 16,4       | 21,0       | 21,0      | 32,9      | 42,7      | 52,6        | 72,3       | 78,9       | 85,5       |
|  | 400V kW            | 17,3      | 17,3       | 22,1       | 22,1      | 34,6      | 45,0      | 55,4        | 76,1       | 83,0       | 90,0       |
|  | 415V kW            | 17,9      | 17,9       | 23,0       | 23,0      | 35,9      | 46,7      | 57,4        | 79,0       | 86,2       | 93,3       |
|  | 440V kW            | 19,0      | 19,0       | 24,4       | 24,4      | 38,1      | 49,5      | 60,9        | 83,7       | 91,3       | 99,0       |
|  | 500V kW            | 21,6      | 21,6       | 27,7       | 27,7      | 43,3      | 56,2      | 69,2        | 95,2       | 103,8      | 112,5      |
|  | 660V kW            | 28,5      | 28,5       | 36,5       | 36,5      | 57,1      | 74,2      | 91,3        | 125,6      | 137,0      | 148,4      |
|  | 690V kW            | 29,8      | 29,8       | 38,2       | 38,2      | 59,7      | 77,6      | 95,5        | 131,3      | 143,2      | 155,2      |
|  | 1000V kW           | -         | -          | -          | -         | -         | -         | -           | -          | -          | -          |
| Rated operational current $I_e (=I_{th})$ at 60°C, enclosed                    | 690V A             | 25        | 25         | 32         | 32        | 40        | 55        | 65          | 90         | 100        | 110        |
| Rated operational power of three-phase resistive loads 50-60Hz, $\cos\phi = 1$ | 220V kW            | 9,5       | 9,5        | 12,2       | 12,2      | 15,2      | 20,9      | 24,7        | 34,3       | 38,1       | 41,9       |
|  | 230V kW            | 9,9       | 9,9        | 12,7       | 12,7      | 15,9      | 21,9      | 25,9        | 35,8       | 39,8       | 43,8       |
|  | 240V kW            | 10,4      | 10,4       | 13,3       | 13,3      | 16,6      | 22,8      | 27,0        | 37,4       | 41,5       | 45,7       |
|  | 380V kW            | 16,4      | 16,4       | 21,0       | 21,0      | 26,3      | 36,2      | 42,7        | 59,2       | 65,7       | 72,3       |
|  | 400V kW            | 17,3      | 17,3       | 22,1       | 22,1      | 27,7      | 38,1      | 45,0        | 62,3       | 69,2       | 76,1       |
|  | 415V kW            | 17,9      | 17,9       | 23,0       | 23,0      | 28,7      | 39,5      | 46,7        | 64,6       | 71,8       | 79,0       |
|  | 440V kW            | 19,0      | 19,0       | 24,4       | 24,4      | 30,4      | 41,9      | 49,5        | 68,5       | 76,1       | 83,7       |
|  | 500V kW            | 21,6      | 21,6       | 27,7       | 27,7      | 34,6      | 47,6      | 56,2        | 77,9       | 86,5       | 95,2       |
|  | 660V kW            | 28,5      | 28,5       | 36,5       | 36,5      | 45,7      | 62,8      | 74,2        | 102,8      | 114,2      | 125,6      |
|  | 690V kW            | 29,8      | 29,8       | 38,2       | 38,2      | 47,7      | 65,7      | 77,6        | 107,4      | 119,4      | 131,3      |
|  | 1000V kW           | -         | -          | -          | -         | -         | -         | -           | -          | -          | -          |
| Minimum cross-section of conductor at load with $I_e (=I_{th})$                | mm <sup>2</sup>    | 4         | 4          | 6          | 6         | 10        | 16        | 25          | 35         | 50         | 50         |
| <b>Utilization category AC2 and AC3</b>  |                    |           |            |            |           |           |           |             |            |            |            |
| <b>Switching of three-phase motors</b>   |                    |           |            |            |           |           |           |             |            |            |            |
| Rated operational current $I_e$ open and enclosed                              | 220V A             | 12        | 15         | 18         | 22        | 24        | 32        | 40          | 50         | 63         | 74         |
|  | 230V A             | 11,5      | 14,5       | 18         | 22        | 24        | 32        | 40          | 50         | 62         | 74         |
|  | 240V A             | 11        | 14         | 18         | 22        | 24        | 32        | 40          | 50         | 62         | 74         |
|  | <b>380-400V A</b>  | <b>10</b> | <b>14</b>  | <b>18</b>  | <b>22</b> | <b>24</b> | <b>32</b> | <b>40</b>   | <b>50</b>  | <b>62</b>  | <b>74</b>  |
|  | 415V A             | 9         | 14         | 18         | 22        | 23        | 30        | 40          | 50         | 62         | 74         |
|  | 440V A             | 9         | 14         | 18         | 22        | 23        | 30        | 40          | 50         | 62         | 74         |
|  | 500V A             | 8,9       | 11,9       | 15         | 15        | 22,5      | 28,5      | 28,5        | 44         | 54         | 64,5       |
|  | 660-690V A         | 6,7       | 9          | 12         | 12        | 17,5      | 21        | 21          | 33         | 42         | 49         |
|  | 1000V A            | -         | -          | -          | -         | -         | -         | -           | -          | -          | -          |
| Rated operational power of three-phase motors 50-60Hz                          | 220-230V kW        | 3         | 4          | 5          | 6         | 6         | 8,5       | 11          | 12,5       | 18,5       | 22         |
|  | 240V kW            | 3         | 4          | 5          | 7         | 7         | 9         | 11,5        | 13,5       | 19         | 23         |
|  | <b>380-400V kW</b> | <b>4</b>  | <b>5,5</b> | <b>7,5</b> | <b>11</b> | <b>11</b> | <b>15</b> | <b>18,5</b> | <b>22</b>  | <b>30</b>  | <b>37</b>  |
|  | 415V kW            | 4,5       | 6          | 8,5        | 12        | 12        | 16        | 20          | 24         | 33         | 40         |
|  | 440V kW            | 4,5       | 6          | 8,5        | 12        | 12        | 16        | 20          | 24         | 33         | 40         |
|  | 500V kW            | 5,5       | 7,5        | 10         | 10        | 15        | 18,5      | 18,5        | 30         | 37         | 45         |
|  | 660-690V kW        | 5,5       | 7,5        | 10         | 10        | 15        | 18,5      | 18,5        | 30         | 37         | 45         |
|  | 1000V kW           | -         | -          | -          | -         | -         | -         | -           | -          | -          | -          |

1) Suitable at 690V for: earthed-neutral systems, overvoltage category I to IV, pollution degree 3 (standard-industry):  $U_{imp} = 8kV$ .  
Data for other conditions on request.

# Contactors

Data according to IEC 947-4-1, EN 60947-4-1, VDE 0660

| Type            | K3-90      | K3-115     | K3-116     | K3-151     | K3-176     | K3-210     | K3-260     | K3-316     | K3-450     | K3-550     | K3-700      | K3-860      | K3-1000     | K3-1200     |
|-----------------|------------|------------|------------|------------|------------|------------|------------|------------|------------|------------|-------------|-------------|-------------|-------------|
| V AC            | 1000       | 1000       | 1000       | 1000       | 1000       | 1000       | 1000       | 1000       | 1000       | 1000       | 690         | 690         | 690         | 690         |
| A               | 1100       | 1200       | 1200       | 1500       | 2000       | 2100       | 2600       | 3200       | 4500       | 5500       | 7000        | 8600        | 10000       | 12000       |
| A               | 540        | 600        | 600        | 720        | 840        | 1020       | 1200       | 1500       | 2400       | 3000       | -           | -           | -           | -           |
| A               | 950        | 1100       | 1000       | 1200       | 1500       | 1600       | 2100       | 2600       | 4500       | 5500       | 7000        | 8000        | 8000        | 10000       |
| A               | 850        | 1000       | 1000       | 1200       | 1500       | 1600       | 2100       | 2600       | 4500       | 5500       | 7000        | 8000        | 8000        | 10000       |
| A               | 600        | 600        | 800        | 1000       | 800        | 1200       | 1900       | 2300       | 3200       | 4400       | 5600        | 6900        | 7000        | 8000        |
| A               | 450        | 450        | 400        | 500        | 600        | 700        | 850        | 1000       | -          | -          | -           | -           | -           | -           |
| <b>A</b>        | <b>160</b> | <b>200</b> | <b>200</b> | <b>250</b> | <b>300</b> | <b>350</b> | <b>450</b> | <b>600</b> | <b>700</b> | <b>800</b> | <b>1000</b> | <b>1100</b> | <b>1200</b> | <b>1350</b> |
| kW              | 60         | 76         | 76         | 95         | 114        | 133        | 171        | 228        | 266        | 304        | 381         | 419         | 457         | 514         |
| kW              | 63         | 79         | 79         | 99         | 119        | 139        | 179        | 238        | 279        | 318        | 398         | 438         | 478         | 537         |
| kW              | 66         | 83         | 83         | 103        | 124        | 145        | 187        | 249        | 291        | 332        | 415         | 457         | 498         | 561         |
| kW              | 105        | 131        | 131        | 165        | 197        | 230        | 296        | 394        | 460        | 526        | 658         | 724         | 789         | 888         |
| kW              | 110        | 138        | 138        | 173        | 208        | 242        | 311        | 415        | 485        | 554        | 692         | 762         | 831         | 935         |
| kW              | 115        | 143        | 143        | 179        | 215        | 251        | 323        | 430        | 503        | 574        | 718         | 790         | 862         | 970         |
| kW              | 121        | 152        | 152        | 190        | 228        | 266        | 342        | 456        | 533        | 609        | 762         | 838         | 914         | 1028        |
| kW              | 138        | 173        | 173        | 216        | 260        | 303        | 389        | 518        | 606        | 692        | 866         | 952         | 1039        | 1169        |
| kW              | 182        | 228        | 228        | 285        | 343        | 400        | 514        | 684        | 800        | 914        | 1143        | 1257        | 1371        | 1543        |
| kW              | 191        | 239        | 239        | 298        | 358        | 418        | 537        | 715        | 836        | 955        | 1195        | 1314        | 1434        | 1613        |
| kW              | 221        | 277        | 216        | 345        | 415        | 433        | 546        | 727        | 692        | 911        | -           | -           | -           | -           |
| A               | 145        | 170        | 170        | 180        | 200        | 280        | 360        | 400        | 550        | 600        | 800         | 875         | 960         | 1080        |
| kW              | 55         | 64         | 64         | 68         | 76         | 106        | 137        | 152        | 209        | 228        | 304         | 333         | 365         | 411         |
| kW              | 57         | 67         | 67         | 71         | 79         | 111        | 143        | 159        | 219        | 239        | 318         | 348         | 382         | 430         |
| kW              | 59         | 70         | 70         | 74         | 83         | 116        | 150        | 166        | 228        | 249        | 332         | 363         | 399         | 448         |
| kW              | 95         | 111        | 111        | 118        | 131        | 184        | 237        | 263        | 362        | 395        | 526         | 575         | 631         | 710         |
| kW              | 100        | 117        | 117        | 124        | 138        | 193        | 249        | 277        | 381        | 415        | 554         | 606         | 665         | 748         |
| kW              | 104        | 122        | 122        | 129        | 143        | 201        | 259        | 287        | 395        | 431        | 575         | 628         | 690         | 776         |
| kW              | 110        | 129        | 129        | 137        | 152        | 213        | 274        | 304        | 419        | 457        | 609         | 666         | 731         | 823         |
| kW              | 125        | 147        | 147        | 155        | 173        | 242        | 312        | 346        | 476        | 519        | 692         | 757         | 831         | 935         |
| kW              | 165        | 194        | 194        | 205        | 228        | 320        | 412        | 457        | 628        | 685        | 914         | 1000        | 1097        | 1234        |
| kW              | 173        | 202        | 202        | 215        | 239        | 334        | 430        | 478        | 657        | 717        | 956         | 1045        | 1147        | 1290        |
| kW              | 166        | 187        | 216        | 277        | 346        | 388        | 499        | 554        | 692        | 866        | -           | -           | -           | -           |
| mm <sup>2</sup> | 95         | 120        | 95         | 95         | 120        | 240        | 2x150      | 2x(30x6)   | 2x(40x5)   | 2x(50x5)   | 2x(60x5)    | 2x(60x6)    | 2x(60x6)    | 2x(60x8)    |
| A               | 90         | 115        | 115        | 150        | 175        | 210        | 260        | 315        | 450        | 550        | 700         | 860         | 1000        | 1200        |
| A               | 90         | 115        | 115        | 150        | 175        | 210        | 260        | 315        | 450        | 550        | 700         | 860         | 1000        | 1200        |
| A               | 90         | 115        | 115        | 150        | 175        | 210        | 260        | 315        | 450        | 550        | 700         | 860         | 1000        | 1200        |
| <b>A</b>        | <b>90</b>  | <b>115</b> | <b>115</b> | <b>150</b> | <b>175</b> | <b>210</b> | <b>260</b> | <b>315</b> | <b>450</b> | <b>550</b> | <b>700</b>  | <b>860</b>  | <b>1000</b> | <b>1200</b> |
| A               | 90         | 115        | 115        | 150        | 175        | 210        | 260        | 315        | 450        | 550        | 700         | 860         | 1000        | 1200        |
| A               | 90         | 115        | 115        | 150        | 175        | 210        | 260        | 315        | 450        | 550        | 700         | 860         | 1000        | 1200        |
| A               | 79         | 79         | 115        | 150        | 175        | 210        | 260        | 315        | 450        | 550        | 700         | 860         | 1000        | 1200        |
| A               | 60         | 60         | 100        | 120        | 140        | 150        | 180        | 240        | 400        | 500        | 630         | 700         | 860         | 1000        |
| A               | 45         | 45         | 45         | 60         | 70         | 85         | 100        | 125        | 200        | 250        | -           | -           | -           | -           |
| kW              | 25         | 33         | 30         | 40         | 50         | 60         | 75         | 90         | 132        | 175        | 225         | 280         | 325         | 390         |
| kW              | 27         | 35         | 35         | 45         | 55         | 65         | 80         | 100        | 140        | 185        | 235         | 290         | 335         | 400         |
| <b>kW</b>       | <b>45</b>  | <b>55</b>  | <b>55</b>  | <b>75</b>  | <b>90</b>  | <b>110</b> | <b>132</b> | <b>160</b> | <b>250</b> | <b>300</b> | <b>400</b>  | <b>500</b>  | <b>580</b>  | <b>680</b>  |
| kW              | 49         | 63         | 59         | 80         | 95         | 115        | 140        | 180        | 257        | 315        | 415         | 515         | 600         | 710         |
| kW              | 49         | 63         | 63         | 85         | 100        | 125        | 150        | 190        | 270        | 335        | 450         | 530         | 630         | 750         |
| kW              | 55         | 55         | 75         | 90         | 100        | 132        | 160        | 210        | 300        | 375        | 500         | 600         | 720         | 850         |
| kW              | 55         | 55         | 90         | 110        | 132        | 132        | 160        | 210        | 375        | 500        | 630         | 700         | 850         | 1000        |
| kW              | 55         | 55         | 55         | 75         | 90         | 110        | 132        | 160        | 280        | 355        | -           | -           | -           | -           |

Contactors, Motor-Starters  
Circuit Breakers  
Manual Motor-Starters  
Switches  
AC-Main Switches  
DC-Switch Disconnector  
Push Buttons  
Representatives, Suppliers

# Contactors

## Data according to IEC 947-4-1, EN 60947-4-1, VDE 0660

| Main Contacts   | Type               | K(G)3-10  | K(G)3-14   | K(G)3-18   | K(G)3-22   | K(G)3-24   | K(G)3-32  | K(G)3-40    | K3-50     | K3-62     | K3-74     |
|---|--------------------|-----------|------------|------------|------------|--|-----------|-------------|-----------|-----------|-----------|
| <b>Utilization category AC4</b>   |                    |           |            |            |            |  |           |             |           |           |           |
| <b>Switching of squirrel cage motors, inching</b>                           |                    |           |            |            |            |  |           |             |           |           |           |
| Rated operational current $I_e$   | 220V A             | 12        | 15         | 18         | 18         | 24   | 30        | 40          | 50        | 63        | 63        |
| open and enclosed   | 230V A             | 11,5      | 14,5       | 18         | 18         | 24   | 30        | 40          | 50        | 62        | 62        |
|   | 240V A             | 11        | 14         | 18         | 18         | 24   | 32        | 40          | 50        | 62        | 62        |
|   | <b>380-400V A</b>  | <b>10</b> | <b>14</b>  | <b>18</b>  | <b>18</b>  | <b>24</b>  | <b>32</b> | <b>40</b>   | <b>50</b> | <b>62</b> | <b>62</b> |
|   | 415V A             | 9         | 14         | 18         | 18         | 23   | 30        | 37          | 45        | 60        | 60        |
|   | 440V A             | 9         | 14         | 18         | 18         | 23   | 30        | 37          | 45        | 55        | 55        |
|   | 500V A             | 9         | 12         | 16         | 16         | 17,5   | 21        | 21          | 33        | 42        | 42        |
|   | 660V A             | 7         | 9          | 9          | 9          | 17   | 20        | 20          | 31        | 40        | 40        |
|   | 690V A             | 6,5       | 8,5        | 8,5        | 8,5        | 17   | 20        | 20          | 31        | 40        | 40        |
|   | 1000V A            | -         | -          | -          | -          | -  | -         | -           | -         | -         | -         |
| Rated operational power of three-phase motors 50-60Hz                       | 220-230V kW        | 3         | 4          | 5          | 5          | 6  | 8,5       | 11          | 12,5      | 18,5      | 18,5      |
|   | 240V kW            | 3         | 4          | 5          | 5          | 7  | 9         | 11,5        | 13,5      | 19        | 19        |
|   | <b>380-400V kW</b> | <b>4</b>  | <b>5,5</b> | <b>7,5</b> | <b>7,5</b> | <b>11</b>  | <b>15</b> | <b>18,5</b> | <b>22</b> | <b>30</b> | <b>30</b> |
|   | 415V kW            | 4,5       | 6          | 8,5        | 8,5        | 12   | 16        | 20          | 24        | 33        | 33        |
|   | 440V kW            | 4,5       | 6          | 8,5        | 8,5        | 12   | 16        | 20          | 24        | 33        | 33        |
|   | 500V kW            | 5,5       | 7,5        | 10         | 10         | 15   | 18,5      | 18,5        | 30        | 37        | 37        |
|   | 660-690V kW        | 5,5       | 7,5        | 10         | 10         | 15   | 18,5      | 18,5        | 30        | 37        | 37        |
|   | 1000V kW           | -         | -          | -          | -          | -  | -         | -           | -         | -         | -         |
| <b>Utilization category AC5a</b>  |                    |           |            |            |            |  |           |             |           |           |           |
| <b>Switching of gas discharge lamps</b>                                     |                    |           |            |            |            |  |           |             |           |           |           |
| Rated operational current $I_e$ per pole at 220/230V                        |                    |           |            |            |            |  |           |             |           |           |           |
| Fluorescent lamps, uncompensated and serial compensated                     | A                  | 20        | 20         | 25         | 25         | 40   | 52        | 64          | 88        | 96        | 104       |
| parallel compensated  | A                  | 7         | 9          | 9          | 9          | 18   | 22        | 22          | 30        | 40        | 40        |
| dual-connection   | A                  | 22,5      | 22,5       | 28         | 28         | 45   | 58        | 72          | 98        | 108       | 117       |
| Metal halide lamps <sup>1)</sup> , uncompensated                            | A                  | 12        | 15         | 19         | 19         | 30   | 39        | 48          | 66        | 72        | 78        |
| parallel compensated  | A                  | 7         | 9          | 9          | 9          | 18   | 22        | 22          | 30        | 40        | 40        |
| Mercury-vapour lamps <sup>2)</sup> , uncompensated                          | A                  | 22,5      | 25         | 28         | 28         | 45   | 58        | 72          | 99        | 108       | 117       |
| parallel compensated  | A                  | 7         | 9          | 9          | 9          | 18   | 22        | 22          | 30        | 40        | 40        |
| Mixed light lamps <sup>3)</sup>   | A                  | 20        | 20         | 25         | 25         | 40   | 52        | 64          | 88        | 96        | 104       |
| <b>LED-Lamps</b>  |                    |           |            |            |            |  |           |             |           |           |           |
| consider the inrush current of the lamp ballast and $\cos\phi$ of the lamp. |                    |           |            |            |            |  |           |             |           |           |           |
| max. lamps per pole ( $I_{rLED} \leq I_{rn}$ )                              |                    |           |            |            |            | = $\frac{\text{inrush current of contactor}}{\text{inrush current of lamp/EVG}}$ |           |             |           |           |           |
| max inrush current of contactor   | A                  | 282       | 282        | 282        | 282        | 564  | 705       | 705         | 987       | 1269      | 1268      |
| <b>Utilization category AC5b</b>  |                    |           |            |            |            |  |           |             |           |           |           |
| <b>Switching of incandescent lamps <sup>4)</sup></b>                        |                    |           |            |            |            |  |           |             |           |           |           |
| Rated operational current $I_e$ per pole at 220/230V                        | A                  | 12,5      | 12,5       | 12,5       | 12,5       | 25   | 31        | 31          | 43        | 56        | 56        |

1) Metal halide lamps and sodium-vapour lamps (high- and low-pressure lamps)

2) High-pressure lamps

3) Blended lamps, containing a mercury high-pressure unit and a tungsten helix in a fluorescent glass bulb (daylight lamps)

4) Current inrush approx.  $16 \times I_e$

# Contactors

Data according to IEC 947-4-1, EN 60947-4-1, VDE 0660

| Type      | K3-90  | K3-115    | K3-151    | K3-176    | K3-210    | K3-260     | K3-316     | K3-450     | K3-550     | K3-700     | K3-860     | K3-1000    | K3-1200    |
|-----------|--|-----------|-----------|-----------|-----------|------------|------------|------------|------------|------------|------------|------------|------------|
| A         | 85   | 98        | 55        | 63        | 85        | 100        | 120        | 150        | 180        | 230        | 280        | 340        | 400        |
| A         | 85   | 98        | 55        | 63        | 85        | 100        | 120        | 150        | 180        | 230        | 280        | 340        | 400        |
| A         | 85   | 98        | 55        | 63        | 85        | 100        | 120        | 150        | 180        | 230        | 280        | 340        | 400        |
| <b>A</b>  | <b>85</b>  | <b>85</b> | <b>55</b> | <b>63</b> | <b>85</b> | <b>100</b> | <b>120</b> | <b>150</b> | <b>180</b> | <b>230</b> | <b>280</b> | <b>340</b> | <b>400</b> |
| A         | 85   | 85        | 55        | 63        | 85        | 100        | 120        | 150        | 180        | 230        | 280        | 340        | 400        |
| A         | 85   | 85        | 55        | 63        | 85        | 100        | 120        | 150        | 180        | 230        | 280        | 340        | 400        |
| A         | 85   | 85        | -         | -         | -         | -          | -          | -          | -          | -          | -          | -          | -          |
| A         | 60   | 60        | -         | -         | -         | -          | -          | -          | -          | -          | -          | -          | -          |
| A         | 57,5   | 57,5      | -         | -         | -         | -          | -          | -          | -          | -          | -          | -          | -          |
| A         | -  | -         | -         | -         | -         | -          | -          | -          | -          | -          | -          | -          | -          |
| kW        | 25   | 30        | 15        | 18,5      | 25        | 30         | 37         | 45         | 51         | 68         | 80         | 110        | 132        |
| kW        | 27   | 32        | 15,5      | 19        | 26        | 31         | 38         | 47         | 53         | 71         | 83         | 115        | 137        |
| <b>kW</b> | <b>45</b>  | <b>45</b> | <b>25</b> | <b>30</b> | <b>45</b> | <b>55</b>  | <b>63</b>  | <b>75</b>  | <b>90</b>  | <b>120</b> | <b>150</b> | <b>185</b> | <b>220</b> |
| kW        | 49   | 49        | 25        | 33        | 45        | 55         | 65         | 80         | 100        | 132        | 160        | 200        | 230        |
| kW        | 49   | 49        | 30        | 34        | 48        | 55         | 67         | 85         | 100        | 132        | 160        | 200        | 230        |
| kW        | 55   | 55        | 25        | 30        | 55        | 65         | 75         | 100        | 110        | 150        | 185        | 220        | 257        |
| kW        | 55   | 55        | 25        | 30        | 55        | 65         | 75         | 100        | 110        | 150        | 185        | 220        | 257        |
| kW        | -  | -         | -         | -         | -         | -          | -          | -          | -          | -          | -          | -          | -          |
| A         | 100  | 120       | 120       | 140       | 180       | 220        | 280        | 360        | 450        | 570        | 700        | 850        | 1000       |
| A         | 55   | 70        | 85        | 100       | 130       | 160        | 200        | 300        | 360        | 460        | 550        | 660        | 800        |
| A         | 112  | 144       | 120       | 140       | 180       | 220        | 280        | 360        | 450        | 570        | 700        | 850        | 1000       |
| A         | 85   | 90        | 95        | 110       | 140       | 180        | 230        | 300        | 380        | 490        | 610        | 750        | 890        |
| A         | 55   | 70        | 75        | 85        | 110       | 140        | 170        | 260        | 300        | 400        | 480        | 580        | 700        |
| A         | 112  | 144       | 120       | 140       | 180       | 220        | 280        | 360        | 450        | 570        | 700        | 850        | 1000       |
| A         | 55   | 70        | 75        | 85        | 110       | 140        | 170        | 260        | 300        | 400        | 480        | 580        | 700        |
| A         | 100  | 120       | 100       | 120       | 160       | 200        | 250        | 320        | 400        | 500        | 600        | 700        | 800        |
|           | $\text{max. lamps per pole } (I_{nLED} \leq I_n) = \frac{\text{inrush current of contactor}}{\text{inrush current of lamp/EVG}}$ |           |           |           |           |            |            |            |            |            |            |            |            |
| A         | 1551   | 1692      | 2115      | 2820      | 2961      | 3666       | 4512       | 6345       | 7755       | 9870       | 12126      | 14100      | 16920      |
| A         | 69   | 75        | 100       | 120       | 160       | 190        | 220        | 260        | 315        | 440        | 500        | 560        | 630        |



# Contactors

## Data according to IEC 947-4-1, EN 60947-4-1, VDE 0660

| Main Contacts                                      |                   | Type | K(G)3-10 | K(G)3-14 | K(G)3-18 | K(G)3-22 | K(G)3-24 | K(G)3-32 | K(G)3-40 | K3-50 | K3-62 | K3-74             |
|--|-------------------|------|----------|----------|----------|----------|----------|----------|----------|-------|-------|-------------------|
| <b>Utilization category AC6a</b>                   |                   |      |          |          |          |          |          |          |          |       |       |                   |
| <b>Transformer primary switching</b>               |                   |      |          |          |          |          |          |          |          |       |       |                   |
| at inrush  |                   | n    | 30       | 30       | 30       | 30       | 30       | 30       | 30       | 30    | 30    | 30                |
| Rated operational current $I_e$                    | 400V              | A    | 4,5      | 5,5      | 7,5      | 7,5      | 10,5     | 13,5     | 13,5     | 20    | 27    | 33                |
| Rated operational power                            | 220-230V          | kVA  | 1,8      | 2,2      | 3        | 3        | 4,2      | 5,4      | 5,4      | 8     | 10,7  | 13                |
| dependent on inrush n                              | 240V              | kVA  | 1,9      | 2,3      | 3,1      | 3,1      | 4,3      | 5,6      | 5,6      | 8,3   | 11,2  | 13,5              |
|  | 380-400V          | kVA  | 3,1      | 3,8      | 5,2      | 5,2      | 7,3      | 9,3      | 9,3      | 13,5  | 18,5  | 22,5              |
| For different inrush-factors x                     | 415-440V          | kVA  | 3,4      | 4,2      | 5,7      | 5,7      | 8        | 10,2     | 10,2     | 15    | 20,5  | 25                |
| use the following formula:                         | 500V              | kVA  | 3,9      | 4,8      | 6,5      | 6,5      | 9        | 11,5     | 11,5     | 17    | 23    | 28                |
| $P_x = P_n * (n/x)$                                | 660-690V          | kVA  | 5,4      | 6,5      | 9        | 9        | 12,5     | 16       | 16       | 24    | 32    | 39                |
| <b>Utilization category AC6b</b>                   |                   |      |          |          |          |          |          |          |          |       |       |                   |
| <b>Switching of three-phase capacitors</b>         |                   |      |          |          |          |          |          |          |          |       |       |                   |
| Maximum inrush current (peak value)                |                   |      |          |          |          |          |          |          |          |       |       |                   |
| as multiple k of the                               |                   |      |          |          |          |          |          |          |          |       |       |                   |
| capacitor rated current                            |                   |      |          |          |          |          |          |          |          |       |       |                   |
| Rated operational current $I_e$                    | 500V              | k    | 35       | 25       | 20       | 20       | 25       | 25       | 25       | 25    | 25    | 20                |
|  |                   | A    | 8        | 12       | 15,5     | 15,5     | 23       | 32       | 32       | 45    | 60    | 70                |
| Rated operational current                          | 220-230V          | kVAr | 3        | 4,5      | 6        | 6        | 8,5      | 12       | 12       | 17    | 24    | 28                |
| ( $\sin\phi=1$ )                                   | 240V              | kVAr | 3,5      | 5        | 6,5      | 6,5      | 9,5      | 13       | 13       | 18,5  | 25    | 29                |
|  | 380-400V          | kVAr | 5        | 7,5      | 10       | 10       | 15       | 20       | 20       | 29    | 39    | 46                |
| For different multiples x                          | 415-440V          | kVAr | 5,5      | 8        | 11       | 11       | 16       | 22       | 22       | 32    | 43    | 50                |
| use the following formula:                         | 500V              | kVAr | 7        | 10       | 13       | 13       | 20       | 26       | 26       | 39    | 50    | 58                |
| $P_x = P_k * (k/x)$                                | 660-690V          | kVAr | 7        | 10       | 13       | 13       | 20       | 26       | 26       | 40    | 50    | 58                |
| <b>Switching of reactive capacitor banks</b>       |                   |      |          |          |          |          |          |          |          |       |       |                   |
| Rated operational current $I_e$                    | 690V              | A    | 8        | 13       | 18       | 20       | 28       | 36       | 42       | 48    | 72    | 108 <sup>1)</sup> |
| Rated operational power                            | 220-230V          | kVAr | 2,9      | 5        | 7        | 7,5      | 11       | 14       | 16       | 20    | 28    | 33                |
|  | 240V              | kVAr | 3,1      | 5,4      | 7        | 8        | 11       | 14       | 17       | 20    | 28    | 36                |
|  | 380-400V          | kVAr | 5        | 9        | 12,5     | 13       | 20       | 25       | 27,5     | 33,3  | 50    | 75 <sup>1)</sup>  |
|  | 415-440V          | kVAr | 5,5      | 9,5      | 13       | 14       | 22       | 27       | 30       | 36    | 53    | 75 <sup>1)</sup>  |
|  | 500V              | kVAr | 6        | 11       | 15       | 17       | 25       | 30       | 36       | 40    | 60    | 75                |
|  | 660-690V          | kVAr | 8        | 15       | 20       | 22       | 33       | 41       | 48       | 55    | 82    | 100               |
|  | 1000V             | kVAr | -        | -        | -        | -        | -        | -        | -        | -     | -     | -                 |
| <b>Utilization category DC1</b>                    |                   |      |          |          |          |          |          |          |          |       |       |                   |
| <b>Switching of resistive load</b>                 |                   |      |          |          |          |          |          |          |          |       |       |                   |
| Time constant $L/R \leq 1ms$                       |                   |      |          |          |          |          |          |          |          |       |       |                   |
| Rated operational current $I_e$                    | 1 pole            | 24V  | A        | 20       | 25       | 32       | 32       | 50       | 65       | 80    | 110   | 130               |
|  |                   | 60V  | A        | 20       | 25       | 32       | 32       | 50       | 65       | 80    | 110   | 130               |
|  |                   | 110V | A        | 6        | 6        | 6        | 6        | 10       | 10       | 12    | 12    | 12                |
|  |                   | 220V | A        | 0,8      | 0,8      | 0,8      | 0,8      | 1,4      | 1,4      | 1,4   | 1,4   | 1,4               |
|  | 3 poles in series | 24V  | A        | 20       | 25       | 32       | 32       | 50       | 65       | 80    | 110   | 130               |
|  |                   | 60V  | A        | 20       | 25       | 32       | 32       | 50       | 65       | 80    | 110   | 130               |
|  |                   | 110V | A        | 20       | 25       | 32       | 32       | 50       | 65       | 80    | 110   | 130               |
|  |                   | 220V | A        | 16       | 20       | 20       | 20       | 30       | 35       | 35    | 63    | 80                |
| <b>Utilization category DC3 and DC5</b>            |                   |      |          |          |          |          |          |          |          |       |       |                   |
| <b>Switching of shunt motors and series motors</b> |                   |      |          |          |          |          |          |          |          |       |       |                   |
| Time constant $L/R \leq 15ms$                      |                   |      |          |          |          |          |          |          |          |       |       |                   |
| Rated operational current $I_e$                    | 1 pole            | 24V  | A        | 20       | 25       | 32       | 32       | 50       | 65       | 80    | 110   | 130               |
|  |                   | 60V  | A        | 6        | 6        | 6        | 6        | 30       | 30       | 30    | 60    | 60                |
|  |                   | 110V | A        | 1,2      | 1,2      | 1,2      | 1,2      | 1,8      | 1,8      | 1,8   | 1,8   | 1,8               |
|  |                   | 220V | A        | 0,2      | 0,2      | 0,2      | 0,2      | 0,2      | 0,2      | 0,2   | 0,25  | 0,25              |
|  | 3 poles in series | 24V  | A        | 20       | 25       | 32       | 32       | 50       | 65       | 80    | 110   | 130               |
|  |                   | 60V  | A        | 20       | 25       | 32       | 32       | 40       | 40       | 40    | 80    | 80                |
|  |                   | 110V | A        | 20       | 20       | 20       | 20       | 40       | 40       | 40    | 80    | 80                |
|  |                   | 220V | A        | 2,5      | 2,5      | 2,5      | 2,5      | 4        | 4        | 4     | 5     | 5                 |

1) Consider resistive load ( $I_{tr}$ ). see page 62

# Contactors



Data according to IEC 947-4-1, EN 60947-4-1, VDE 0660

| Type | K3-90 | K3-115 | K3-151 | K3-176 | K3-210 | K3-260 | K3-316 | K3-450 | K3-550 | K3-700 | K3-860 | K3-1000 | K3-1200 |
|------|-------|--------|--------|--------|--------|--------|--------|--------|--------|--------|--------|---------|---------|
| n    | 30    | 30     | 30     | 30     | 30     | 30     | 30     | 30     | 30     | 30     | 30     | 30      | 30      |
| A    | 38    | 50     | 65     | 80     | 90     | 120    | 142    | 203    | 248    | 315    | 390    | 450     | 540     |
| kVA  | 15    | 20     | 25     | 30     | 34     | 45     | 54     | 77     | 95     | 120    | 148    | 170     | 200     |
| kVA  | 15,5  | 20,5   | 27     | 33     | 37     | 50     | 59     | 80     | 100    | 130    | 160    | 185     | 220     |
| kVA  | 26    | 34     | 45     | 55     | 60     | 80     | 95     | 140    | 170    | 210    | 270    | 310     | 370     |
| kVA  | 29    | 38     | 46     | 57     | 63     | 85     | 100    | 145    | 175    | 220    | 280    | 320     | 380     |
| kVA  | 33    | 43     | 55     | 69     | 75     | 100    | 120    | 170    | 210    | 270    | 330    | 380     | 460     |
| kVA  | 45    | 60     | 56     | 69     | 100    | 135    | 160    | 200    | 250    | 320    | 350    | 500     | 600     |
| k    | 20    | 20     | 20     | 20     | 25     | 20     | 20     | 20     | 20     | 20     | 20     | 20      | 20      |
| A    | 87    | 100    | 120    | 155    | 195    | 225    | 255    | 300    | 370    | 440    | 520    | 680     | 760     |
| kVAr | 33    | 38     | 45     | 60     | 75     | 90     | 100    | 115    | 145    | 170    | 200    | 260     | 290     |
| kVAr | 36    | 42     | 52     | 62     | 78     | 94     | 104    | 120    | 150    | 175    | 205    | 270     | 300     |
| kVAr | 57    | 65     | 80     | 100    | 130    | 155    | 170    | 200    | 250    | 300    | 350    | 450     | 500     |
| kVAr | 60    | 70     | 95     | 110    | 135    | 165    | 175    | 210    | 260    | 310    | 360    | 465     | 520     |
| kVAr | 70    | 80     | 100    | 130    | 170    | 194    | 220    | 260    | 320    | 380    | 450    | 590     | 660     |
| kVAr | 70    | 80     | 100    | 130    | 170    | 194    | 220    | 260    | 320    | 380    | 450    | 590     | 660     |
| A    | 115   | 144    | 115    | 140    | 200    | 225    | 250    | 330    | 420    | 550    | 600    | 680     | 760     |
| kVAr | 45    | 55     | 43     | 53     | 76     | 85     | 95     | 125    | 160    | 209    | 228    | 260     | 290     |
| kVAr | 45    | 55     | 45     | 55     | 80     | 90     | 100    | 130    | 170    | 220    | 240    | 280     | 310     |
| kVAr | 80    | 100    | 75     | 90     | 130    | 145    | 160    | 210    | 270    | 350    | 390    | 440     | 480     |
| kVAr | 100   | 120    | 80     | 100    | 140    | 160    | 170    | 230    | 290    | 380    | 420    | 470     | 530     |
| kVAr | 105   | 125    | 95     | 120    | 170    | 190    | 210    | 280    | 350    | 450    | 500    | 570     | 640     |
| kVAr | 120   | 148    | 125    | 150    | 200    | 230    | 260    | 350    | 450    | 600    | 650    | 700     | 800     |
| kVAr | 160   | 200    | 155    | 200    | 300    | 340    | 400    | 500    | 650    | -      | -      | -       | -       |
| A    | 160   | 200    | -      | -      | -      | -      | -      | -      | -      | -      | -      | -       | -       |
| A    | 160   | 200    | -      | -      | -      | -      | -      | -      | -      | -      | -      | -       | -       |
| A    | 20    | 25     | -      | -      | -      | -      | -      | -      | -      | -      | -      | -       | -       |
| A    | 2     | 2,5    | -      | -      | -      | -      | -      | -      | -      | -      | -      | -       | -       |
| A    | 160   | 200    | 200    | 250    | 350    | 400    | 450    | 600    | 760    | 1000   | 1100   | 1200    | 1350    |
| A    | 160   | 200    | 200    | 250    | 350    | 400    | 450    | 600    | 760    | 1000   | 1100   | 1200    | 1350    |
| A    | 160   | 200    | 150    | 170    | 250    | 280    | 315    | 400    | 480    | 560    | 630    | 800     | 900     |
| A    | 100   | 160    | 80     | 100    | 150    | 180    | 200    | 250    | 315    | 400    | 450    | 500     | 600     |
| A    | 160   | 200    | -      | -      | -      | -      | -      | -      | -      | -      | -      | -       | -       |
| A    | 85    | 110    | -      | -      | -      | -      | -      | -      | -      | -      | -      | -       | -       |
| A    | 2     | 2,5    | -      | -      | -      | -      | -      | -      | -      | -      | -      | -       | -       |
| A    | 0,5   | 0,5    | -      | -      | -      | -      | -      | -      | -      | -      | -      | -       | -       |
| A    | 160   | 200    | -      | -      | -      | -      | -      | -      | -      | -      | -      | -       | -       |
| A    | 100   | 110    | -      | -      | -      | -      | -      | -      | -      | -      | -      | -       | -       |
| A    | 100   | 110    | -      | -      | -      | -      | -      | -      | -      | -      | -      | -       | -       |
| A    | 7     | 8      | -      | -      | -      | -      | -      | -      | -      | -      | -      | -       | -       |

Contactors, Motor-Starters  
Circuit Breakers  
Manual Motor-Starters  
Switches  
AC-Main Switches  
DC-Switch Disconnectors  
Push Buttons  
Representatives, Suppliers

# Contactors









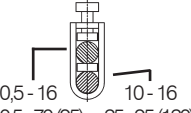

## Data according to IEC 947-4-1, EN 60947-4-1, VDE 0660

| Main Contacts   | Type                        | K(G)3-10                          | K(G)3-14  | K(G)3-18 | K(G)3-22 | K(G)3-24  | K(G)3-32 | K(G)3-40 | K3-50   | K3-62 | K3-74 |     |
|---|-----------------------------|-----------------------------------|---|----------|----------|---|----------|----------|---|-------|-------|-----|
| <b>Maximum ambient temperature</b>  |                             |                                   |   |          |          |   |          |          |   |       |       |     |
| Operation   | open                        | °C -40 to +60 (+90) <sup>1)</sup> |   |          |          |   |          |          |   |       |       |     |
|   | enclosed                    | °C -40 to +40                     |   |          |          |   |          |          |   |       |       |     |
| with thermal overload relay   | open                        | °C -25 to +60                     |   |          |          |   |          |          |   |       |       |     |
|   | enclosed                    | °C -25 to +40                     |   |          |          |   |          |          |   |       |       |     |
| Storage   |                             | °C -50 to +90                     |   |          |          |   |          |          |   |       |       |     |
| <b>Short circuit protection</b>   |                             |                                   |   |          |          |   |          |          |   |       |       |     |
| for contactors without thermal overload relay   |                             |                                   |   |          |          |   |          |          |   |       |       |     |
| Coordination-type "1" according to IEC 947-4-1  |                             |                                   |   |          |          |   |          |          |   |       |       |     |
| Contact welding without hazard of persons   |                             |                                   |   |          |          |   |          |          |   |       |       |     |
| max. fuse size  | gL (gG)                     | A                                 | 63  | 63       | 63       | 63  | 100      | 100      | 100   | 160   | 160   | 160 |
| Coordination-type "2" according to IEC 947-4-1  |                             |                                   |   |          |          |   |          |          |   |       |       |     |
| Light contact welding accepted  |                             |                                   |   |          |          |   |          |          |   |       |       |     |
| max. fuse size  | gL (gG)                     | A                                 | 25  | 35       | 35       | 35  | 50       | 50       | 50  | 100   | 125   | 125 |
| Contact welding not accepted  |                             |                                   |   |          |          |   |          |          |   |       |       |     |
| max. fuse size  | gL (gG)                     | A                                 | 16  | 16       | 16       | 16  | 25       | 35       | 35  | 50    | 63    | 63  |
| For contactors with thermal overload relay the device with the smaller admissible backup fuse (contactor or thermal overload relay) determines the fuse size. |                             |                                   |   |          |          |   |          |          |   |       |       |     |
| <b>Cable cross-sections</b>   |                             |                                   |   |          |          |   |          |          |   |       |       |     |
| for contactors without thermal overload relay   |                             |                                   |   |          |          |   |          |          |   |       |       |     |
| 1 cable per clamp   |                             |                                   |   |          |          |   |          |          |   |       |       |     |
| main connector  | solid or stranded           | mm <sup>2</sup>                   |  |          |          |  |          |          |  |       |       |     |
|   |                             | flexible                          | mm <sup>2</sup> 0,75 - 6  |          |          | mm <sup>2</sup> 1,5 - 25  |          |          | mm <sup>2</sup> 4 - 50  |       |       |     |
|   |                             | flexible with multicore cable end | mm <sup>2</sup> 1 - 4   |          |          | mm <sup>2</sup> 2,5 - 16  |          |          | mm <sup>2</sup> 10 - 35   |       |       |     |
| 2 cables per clamp  |                             |                                   |   |          |          |   |          |          |   |       |       |     |
|   | solid or stranded           | mm <sup>2</sup>                   | 6+(1-6) / 4+(0,75-4)  |          |          | 16+(2,5-16) / 10+(4-16)   |          |          | 50+4 / 35+6 / 25+(6-16)   |       |       |     |
|   |                             | flexible                          | 2,5+(0,75-2,5) / 1,5+(0,75-1,5)   |          |          | 6+(4-16) / 4+(2,5-16)   |          |          | 16+(6-16) / 10+(6-16)   |       |       |     |
|   |                             | flexible                          | 6+(1,5-4) / 4+(1-4)   |          |          | 16+(2,5-6) / 10+(4-10)  |          |          | 50+(4-10) / 35+(4-16)   |       |       |     |
| 2,5+(0,75-2,5) / 1,5+(0,75-1,5)   |                             |                                   |   |          |          |   |          |          |   |       |       |     |
| 6+(4-16) / 4+(2,5-16)   |                             |                                   |   |          |          |   |          |          |   |       |       |     |
| 25+(4-25) / 16+(4-16)   |                             |                                   |   |          |          |   |          |          |   |       |       |     |
| <b>1 cable per clamp</b>  |                             |                                   |   |          |          |   |          |          |   |       |       |     |
| main connector  | solid                       | AWG                               | 18 - 10   |          |          | 16 - 10   |          |          | 12 - 10   |       |       |     |
|   | flexible                    | AWG                               | 18 - 10   |          |          | 14 - 4  |          |          | 10 - 0  |       |       |     |
| <b>2 cables per clamp</b>   |                             |                                   |   |          |          |   |          |          |   |       |       |     |
|   | solid                       | AWG                               | 10+(16-10) / 12+(18-12)   |          |          | 10+(16-10) / 12+(18-12)   |          |          | 10+(12-10) / 12+12  |       |       |     |
|   |                             | flexible                          | 14+(18-14) / 16+(18-16)   |          |          | 14+(18-14) / 16+(18-16)   |          |          | 1+(12-10) / 2+(8-12)  |       |       |     |
|   |                             | flexible                          | 10+(14-10) / 12+(18-12)   |          |          | 4+(18-12) / 6+(18-8)  |          |          | 3+(12-8) / 4+(10-6)   |       |       |     |
| 14+(18-14) / 16+(18-16)   |                             |                                   |   |          |          |   |          |          |   |       |       |     |
| 8+(18-8) / 10+(18-12)   |                             |                                   |   |          |          |   |          |          |   |       |       |     |
| <b>Frequency of operations z</b>  |                             |                                   |   |          |          |   |          |          |   |       |       |     |
| Contactors without thermal overload relay   |                             |                                   |   |          |          |   |          |          |   |       |       |     |
|   | without load                | 1/h                               | 10000   |          |          | 7000  |          |          | 7000  |       |       |     |
|   | AC3, I <sub>e</sub>         | 1/h                               | 600   |          |          | 600   |          |          | 400   |       |       |     |
|   | AC4, I <sub>e</sub>         | 1/h                               | 120   |          |          | 120   |          |          | 120   |       |       |     |
|   | DC3, I <sub>e</sub>         | 1/h                               | 600   |          |          | 600   |          |          | 400   |       |       |     |
| <b>Mechanical life</b>  |                             |                                   |   |          |          |   |          |          |   |       |       |     |
| AC operated   | S x 10 <sup>6</sup>         |                                   | 10  |          |          | 10  |          |          | 10  |       |       |     |
| DC operated   | S x 10 <sup>6</sup>         |                                   | 10  |          |          | 10  |          |          | 10  |       |       |     |
| DC-solenoid operated (KG3)  | S x 10 <sup>6</sup>         |                                   | 50  |          |          | 50  |          |          | -   |       |       |     |
| <b>Short time current</b>   |                             |                                   |   |          |          |   |          |          |   |       |       |     |
| 10s-current   | A                           | 96                                | 120   | 144      | 176      | 184   | 240      | 296      | 450   | 504   | 592   |     |
|   | A                           | 42                                | 52  | 58       | 66       | 80  | 97       | 110      | 195   | 203   | 222   |     |
| <b>Power loss per pole</b>  |                             |                                   |   |          |          |   |          |          |   |       |       |     |
| contact resistance  | at I <sub>e</sub> /AC3 400V | W                                 | 0,21  | 0,35     | 0,5      | 0,75  | 0,7      | 1,3      | 2   | 2,2   | 3,9   | 5,5 |
|   | mOhm                        |                                   | 2,1   | 1,8      | 1,5      | 1,5   | 1,2      | 1,2      | 1,2   | 1     | 1     | 1   |
| <b>Resistance to shock acc. to IEC 60068-2-27</b>   |                             |                                   |   |          |          |   |          |          |   |       |       |     |
| Shock time 20ms sine-wave   | NO                          | g                                 | 10  | 10       | 10       | 10  | 8        | 8        | 8   | 8     | 8     | 8   |
|   | NC                          | g                                 | 6   | 6        | 6        | 6   | -        | -        | -   | -     | -     | -   |

1) With reduced control voltage range 0,9 up to 1,0 x U<sub>s</sub> and with reduced rated current I<sub>e</sub>/AC1 according to I<sub>e</sub>/AC3

# Contactors

Data according to IEC 947-4-1, EN 60947-4-1, VDE 0660

| Type                | K3-90   | K3-115        | K3-116  | K3-151 | K3-176  | K3-210 | K3-260   | K3-316 | K3-450  | K3-550 | K3-700  | K3-860 | K3-1000   | K3-1200 |   |  |   |  |   |  |   |  |
|---------------------|---|---------------|---|--------|---|--------|--|--------|---|--------|---|--------|---|---------|---|--|---|--|---|--|---|--|
| °C                  | -40 bis +60 (+90) <sup>1)</sup>   |               |   |        |   |        |  |        |   |        |   |        |   |         |   |  |   |  |   |  |   |  |
| °C                  | -40 to +40  |               |   |        |   |        |  |        |   |        |   |        |   |         |   |  |   |  |   |  |   |  |
| °C                  | -25 to +60  |               |   |        |   |        |  |        |   |        |   |        |   |         |   |  |   |  |   |  |   |  |
| °C                  | -25 to +40  |               |   |        |   |        |  |        |   |        |   |        |   |         |   |  |   |  |   |  |   |  |
| °C                  | -50 to +90  |               |   |        |   |        |  |        |   |        |   |        |   |         |   |  |   |  |   |  |   |  |
|                     |   |               |   |        |   |        |  |        |   |        |   |        |   |         |   |  |   |  |   |  |   |  |
| A                   | 250   | 250           | 200   | 250    | 315   | 400    | 450  | 500    | 630   | 630    | 800   | 1000   | 1000  | 1250    |   |  |   |  |   |  |   |  |
| A                   | 160   | 200           | 160   | 200    | 250   | 315    | 400  | 400    | 500   | 560    | -   | -      | -   | -       |   |  |   |  |   |  |   |  |
| A                   | 100   | 125           | 125   | 160    | 200   | 250    | 315  | -      | -   | -      | -   | -      | -   | -       |   |  |   |  |   |  |   |  |
| mm <sup>2</sup>     |  |               |  |        |  |        |  |        |  |        |  |        |  |         |  |  |  |  |  |  |  |  |
| mm <sup>2</sup>     | 0,5 - 16  | 10 - 16       | busbar<br>18 x 4<br>screw<br>M8   |        | busbar<br>25 x 6<br>screw<br>M10  |        | busbar<br>30 x 5<br>screw<br>M12   |        | busbar<br>40 x 6<br>screw<br>M12  |        | busbar<br>50 x 8<br>screw<br>M12  |        | busbar<br>50 x 8<br>screw<br>M14  |         | busbar<br>50 x 10<br>screw<br>2 x M12   |  |   |  |   |  |   |  |
| mm <sup>2</sup>     | 0,5 - 70 (95)   | 25 - 95 (120) |   |        |   |        |  |        |   |        |   |        |   |         |   |  |   |  |   |  |   |  |
| mm <sup>2</sup>     | 0,5 - 70  | 10 - 95       |   |        |   |        |  |        |   |        |   |        |   |         |   |  |   |  |   |  |   |  |
| mm <sup>2</sup>     | 0,5 - 95 + 10 - 120   |               |   |        |   |        |  |        |   |        |   |        |   |         |   |  |   |  |   |  |   |  |
| mm <sup>2</sup>     | 0,5 - 70 + 25 - 95  |               |   |        |   |        |  |        |   |        |   |        |   |         |   |  |   |  |   |  |   |  |
| AWG                 | 18 - 10   | -             |   |        |   |        |  |        |   |        |   |        |   |         |   |  |   |  |   |  |   |  |
| AWG                 | 18 - 3/0  | 8 - 4/0       |   |        |   |        |  |        |   |        |   |        |   |         |   |  |   |  |   |  |   |  |
| AWG                 | -   |               |   |        |   |        |  |        |   |        |   |        |   |         |   |  |   |  |   |  |   |  |
| AWG                 | 18 - 3/0 + 8 - 4/0  |               |   |        |   |        |  |        |   |        |   |        |   |         |   |  |   |  |   |  |   |  |
| 1/h                 | 3000  |               | 1200  |        | 1200  |        | 1200   |        | 1200  |        | 300   |        | 300   |         |   |  |   |  |   |  |   |  |
| 1/h                 | 300   |               | 240   |        | 150   |        | 50   |        | 25  |        | 20  |        | 20  |         |   |  |   |  |   |  |   |  |
| 1/h                 | 120   |               | -   |        | -   |        | -  |        | -   |        | -   |        | -   |         |   |  |   |  |   |  |   |  |
| 1/h                 | 300   |               | -   |        | -   |        | -  |        | -   |        | -   |        | -   |         |   |  |   |  |   |  |   |  |
| S x 10 <sup>6</sup> | 5   |               | 10  |        | 5   |        | 5  |        | 5   |        | 5 <sup>3)</sup>   |        | 5 <sup>3)</sup>   |         |   |  |   |  |   |  |   |  |
| S x 10 <sup>6</sup> | 5   |               | 10  |        | 5   |        | 5  |        | 5   |        | 5 <sup>3)</sup>   |        | 5 <sup>3)</sup>   |         |   |  |   |  |   |  |   |  |
| S x 10 <sup>6</sup> | -   |               | -   |        | -   |        | -  |        | -   |        | -   |        | -   |         |   |  |   |  |   |  |   |  |
| A                   | 680   | 880           | 920   | 1200   | 1400  | 1800   | 2200   | 2600   | 3600  | 4400   | 5600  | 6900   | 8000  | 9600    |   |  |   |  |   |  |   |  |
| A                   | 275   | 330           | 410   | 500    | 575   | 800    | 900  | 1000   | 1400  | 1750   | 2200  | 2600   | 3000  | 3600    |   |  |   |  |   |  |   |  |
| W                   | 4,8   | 7,9           | 7,9   | 9      | 11  | 8      | 11   | 14,9   | 26,3  | 33,3   | 49  | 59,2   | 60  | 72      |   |  |   |  |   |  |   |  |
| mOhm                | 0,6   | 0,5           | 0,5   | 0,4    | 0,35  | 0,18   | 0,16   | 0,15   |   |        |   |        |   |         |   |  |   |  |   |  |   |  |
| g                   | 7   | 7             | -   | -      | -   | -      | -  | -      | -   | -      | -   | -      | -   | -       |   |  |   |  |   |  |   |  |
| g                   | 5   | 5             | -   | -      | -   | -      | -  | -      | -   | -      | -   | -      | -   | -       |   |  |   |  |   |  |   |  |

1) With reduced control voltage range 0,9 up to 1,0 x U<sub>s</sub> and with reduced rated current I<sub>b</sub>/AC1 according to I<sub>b</sub>/AC3

2) With reduced control voltage range 1,0 x U<sub>s</sub> and with reduced rated current I<sub>b</sub>/AC1 according to I<sub>b</sub>/AC3

3) After each 1x10<sup>6</sup> operations magnetic core and built-in auxiliary contact block must be changed

# Contactors

## Data according to IEC 947-4-1, EN 60947-4-1, VDE 0660

| Auxiliary Contacts  |  |  | Type  | K(G)3-10              | K(G)3-14 | K(G)3-18 | K(G)3-22 | K(G)3-24              | K(G)3-32 | K(G)3-40 | K3-50 | K3-62 | K3-74 |
|---|--|--|---|-----------------------|----------|----------|----------|-----------------------|----------|----------|-------|-------|-------|
| <b>Rated insulation voltage <math>U_i</math> <sup>1)</sup></b>  |  |  | V~  | 690                   |          |          |          | -                     |          | -        |       |       |       |
| <b>Thermal rated current <math>I_{th}</math> to 690V</b>  |  |  |   |                       |          |          |          |                       |          |          |       |       |       |
| Ambient temperature   |  |  | 40°C A  | 10                    |          |          |          | (16) <sup>5)</sup>    |          | -        |       |       |       |
|   |  |  | 60°C A  | 6                     |          |          |          | (12) <sup>5)</sup>    |          | -        |       |       |       |
| <b>Utilization category AC15</b>  |  |  |   |                       |          |          |          |                       |          |          |       |       |       |
| Rated operational current $I_e$   |  |  | 220-240V A  | 3                     |          |          |          | (12) <sup>5)</sup>    |          | -        |       |       |       |
|   |  |  | 380-415V A  | 2                     |          |          |          | (4) <sup>5)</sup>     |          | -        |       |       |       |
|   |  |  | 440V A  | 1,6                   |          |          |          | (4) <sup>5)</sup>     |          | -        |       |       |       |
|   |  |  | 500V A  | 1,2                   |          |          |          | (3) <sup>5)</sup>     |          | -        |       |       |       |
|   |  |  | 660-690V A  | 0,6                   |          |          |          | (1) <sup>5)</sup>     |          | -        |       |       |       |
| <b>Utilization category DC13</b>  |  |  |   |                       |          |          |          |                       |          |          |       |       |       |
| Rated operational current $I_e$   |  |  | 60V A   | 3,5                   |          |          |          | (8) <sup>5)</sup>     |          | -        |       |       |       |
|   |  |  | 110V A  | 0,5                   |          |          |          | (1) <sup>5)</sup>     |          | -        |       |       |       |
|   |  |  | 220V A  | 0,1                   |          |          |          |                       |          | -        |       |       |       |
| <b>Short circuit protection</b><br>short-circuit current 1kA,<br>contact welding not accepted<br>max. fuse size |  |  | gL (gG) A   | 20                    |          |          |          | (25) <sup>5)</sup>    |          | -        |       | -     |       |
| <b>Control Circuit</b><br><b>Power consumption of coils</b>   |  |  |   |                       |          |          |          |                       |          |          |       |       |       |
| AC operated   |  |  | inrush VA   | 33-45                 |          |          |          | 90-115                |          | 140-165  |       |       |       |
|   |  |  | sealed VA   | 7-10                  |          |          |          | 9-13                  |          | 13-18    |       |       |       |
|   |  |  | W   | 2,6-3                 |          |          |          | 2,7-4                 |          | 5,4-7    |       |       |       |
| DC operated   |  |  | inrush W  | 75                    |          |          |          | 140                   |          | 200      |       |       |       |
| double winding coil   |  |  | sealed W  | 2                     |          |          |          | 2                     |          | 6        |       |       |       |
| DC solenoid operated (KG3)  |  |  | inrush W  | 3                     |          |          |          | 4                     |          | -        |       |       |       |
|   |  |  | sealed W  | 3                     |          |          |          | 4                     |          | -        |       |       |       |
| <b>Operation range of coils</b><br>in multiples of control voltage $U_c$  |  |  |   |                       |          |          |          |                       |          |          |       |       |       |
|   |  |  | AC operated                                       | 0,85-1,1              |          |          |          | 0,85-1,1              |          | 0,85-1,1 |       |       |       |
|   |  |  | DC operated                                       | 0,8-1,1               |          |          |          | 0,8-1,1               |          | 0,8-1,1  |       |       |       |
| <b>Switching time</b> at control voltage $U_c \pm 10\%$ <sup>2) 3)</sup>  |  |  |   |                       |          |          |          |                       |          |          |       |       |       |
| AC operated   |  |  | make time ms                                      | 8-16                  |          |          |          | 10-25                 |          | 12-28    |       |       |       |
|   |  |  | release time ms                                   | 5-13                  |          |          |          | 8-15                  |          | 8-15     |       |       |       |
|   |  |  | arc duration ms                                   | 10-15                 |          |          |          | 10-15                 |          | 10-15    |       |       |       |
| DC operated   |  |  | make time ms                                      | 8-12                  |          |          |          | 10-20                 |          | 12-23    |       |       |       |
| double winding coil   |  |  | release time ms                                   | 8-13                  |          |          |          | 10-15                 |          | 10-18    |       |       |       |
|   |  |  | arc duration ms                                   | 10-15                 |          |          |          | 10-15                 |          | 10-15    |       |       |       |
| DC solenoid operated (KG3)  |  |  | make time ms                                      | 65 - 85               |          |          |          | 65 - 85               |          | -        |       |       |       |
|   |  |  | release time ms                                   | 20 - 30 <sup>4)</sup> |          |          |          | 20 - 30 <sup>4)</sup> |          | -        |       |       |       |
|   |  |  | arc duration ms                                   | 10-15                 |          |          |          | 10-15                 |          | -        |       |       |       |
| <b>Cable cross-section</b>  |  |  |   |                       |          |          |          |                       |          |          |       |       |       |
| Auxiliary connector   |  |  | solid mm <sup>2</sup>                             | 0,75-6                |          |          |          | -                     |          | -        |       |       |       |
|   |  |  | flexible mm <sup>2</sup>                          | 1-4                   |          |          |          | -                     |          | -        |       |       |       |
|   |  |  | flexible with multicore cable end mm <sup>2</sup> | 0,75-4                |          |          |          | -                     |          | -        |       |       |       |
| Magnet coil   |  |  | solid mm <sup>2</sup>                             | 0,75-2,5              |          |          |          | 0,75-2,5              |          | 0,75-2,5 |       |       |       |
|   |  |  | flexible mm <sup>2</sup>                          | 0,5-2,5               |          |          |          | 0,5-2,5               |          | 0,5-2,5  |       |       |       |
|   |  |  | flexible with multicore cable end mm <sup>2</sup> | 0,5-1,5               |          |          |          | 0,5-1,5               |          | 0,5-1,5  |       |       |       |
| Clamps per pole   |  |  |   | 2                     |          |          |          | 2                     |          | 2        |       |       |       |
| Auxiliary connector   |  |  | solid AWG   | 18 - 10               |          |          |          | -                     |          | -        |       |       |       |
|   |  |  | flexible AWG                                      | 18 - 10               |          |          |          | -                     |          | -        |       |       |       |
| Magnet coil   |  |  | solid AWG   | 14 - 12               |          |          |          | 14 - 12               |          | 14 - 12  |       |       |       |
|   |  |  | flexible AWG                                      | 18 - 12               |          |          |          | 18 - 12               |          | 18 - 12  |       |       |       |
| Clamps per pole   |  |  |   | 2                     |          |          |          | 2                     |          | 2        |       |       |       |

1) Suitable for: earthed-neutral systems, overvoltage category I to IV, pollution degree 3 (standard-industry):  $U_{imp} = 8kV$ . Data for other conditions on request

2) Total breaking time = release time + arc duration

3) Values for delay of the release time of the make contact and the make time of the break contact will be increased, if magnet coils are protected against voltage peaks (varistor, RC-unit, diode-unit)

4) with built-in coil suppressor 5) for contactors KG3-...A.. only

# Contactors

Data according to IEC 947-4-1, EN 60947-4-1, VDE 0660

| Type            | K3-90               | K3-115 | K3-116 | K3-151               | K3-176 | K3-210 | K3-260               | K3-316 | K3-450                           | K3-550 | K3-700               | K3-860 | K3-1000              | K3-1200 |
|-----------------|---------------------|--------|--------|----------------------|--------|--------|----------------------|--------|----------------------------------|--------|----------------------|--------|----------------------|---------|
| V~              | -                   | -      | -      | -                    | -      | -      | -                    | -      | 690                              | -      | 690                  | -      | 690                  | -       |
| A               | -                   | -      | -      | -                    | -      | -      | -                    | -      | 10                               | -      | 10                   | -      | 10                   | -       |
| A               | -                   | -      | -      | -                    | -      | -      | -                    | -      | -                                | -      | -                    | -      | -                    | -       |
| -               | -                   | -      | -      | -                    | -      | -      | -                    | -      | -                                | -      | -                    | -      | -                    | -       |
| A               | -                   | -      | -      | -                    | -      | -      | -                    | -      | 3                                | -      | 3                    | -      | 3                    | -       |
| A               | -                   | -      | -      | -                    | -      | -      | -                    | -      | 2                                | -      | 2                    | -      | 2                    | -       |
| A               | -                   | -      | -      | -                    | -      | -      | -                    | -      | 1,5                              | -      | 1,5                  | -      | 1,5                  | -       |
| A               | -                   | -      | -      | -                    | -      | -      | -                    | -      | 1,5                              | -      | 1,5                  | -      | 1,5                  | -       |
| A               | -                   | -      | -      | -                    | -      | -      | -                    | -      | 1                                | -      | 1                    | -      | 1                    | -       |
| A               | -                   | -      | -      | -                    | -      | -      | -                    | -      | -                                | -      | -                    | -      | -                    | -       |
| A               | -                   | -      | -      | -                    | -      | -      | -                    | -      | 1                                | -      | 1                    | -      | 1                    | -       |
| A               | -                   | -      | -      | -                    | -      | -      | -                    | -      | 0,5                              | -      | 0,5                  | -      | 0,5                  | -       |
| A               | -                   | -      | -      | -                    | -      | -      | -                    | -      | -                                | -      | -                    | -      | -                    | -       |
| A               | -                   | -      | -      | -                    | -      | -      | -                    | -      | 10                               | -      | 10                   | -      | 10                   | -       |
| VA              | 165-220             | -      | -      | 350                  | -      | -      | 360                  | -      | 800-950                          | -      | 1350-1600            | -      | 2400                 | -       |
| VA              | 2,5-5               | -      | -      | 5                    | -      | -      | 5                    | -      | 9-11                             | -      | 21-25                | -      | 70                   | -       |
| W               | 2,5-5               | -      | -      | 5                    | -      | -      | 5                    | -      | 9-11                             | -      | 21-25                | -      | 70                   | -       |
| W               | 250                 | -      | -      | 350                  | -      | -      | 360                  | -      | 700-850                          | -      | 1300-1550            | -      | 2100                 | -       |
| W               | 5                   | -      | -      | 5                    | -      | -      | 5                    | -      | 8-10                             | -      | 18-22                | -      | 60                   | -       |
| W               | -                   | -      | -      | -                    | -      | -      | -                    | -      | -                                | -      | -                    | -      | -                    | -       |
| W               | -                   | -      | -      | -                    | -      | -      | -                    | -      | -                                | -      | -                    | -      | -                    | -       |
| ms              | 0,85-1,1<br>0,8-1,1 | -      | -      | 0,85-1,1<br>0,85-1,1 | -      | -      | 0,85-1,1<br>0,85-1,1 | -      | 0,85-1,1<br>0,85-1,1             | -      | 0,85-1,1<br>0,85-1,1 | -      | 0,85-1,1<br>0,85-1,1 | -       |
| ms              | 20-35               | -      | -      | 30-60                | -      | -      | 40-60                | -      | 50-100                           | -      | 50-100               | -      | 50-100               | -       |
| ms              | 35-50               | -      | -      | 30-80                | -      | -      | 15-45                | -      | 150-200 / 500-1000 <sup>1)</sup> | -      | 25-50                | -      | 25-50                | -       |
| ms              | 10-15               | -      | -      | -                    | -      | -      | -                    | -      | -                                | -      | -                    | -      | -                    | -       |
| ms              | 20-35               | -      | -      | 30-60                | -      | -      | 40-60                | -      | -                                | -      | -                    | -      | -                    | -       |
| ms              | 35-50               | -      | -      | 30-80                | -      | -      | 15-45                | -      | -                                | -      | -                    | -      | -                    | -       |
| ms              | 10-15               | -      | -      | -                    | -      | -      | -                    | -      | -                                | -      | -                    | -      | -                    | -       |
| ms              | -                   | -      | -      | -                    | -      | -      | -                    | -      | -                                | -      | -                    | -      | -                    | -       |
| ms              | -                   | -      | -      | -                    | -      | -      | -                    | -      | -                                | -      | -                    | -      | -                    | -       |
| ms              | -                   | -      | -      | -                    | -      | -      | -                    | -      | -                                | -      | -                    | -      | -                    | -       |
| mm <sup>2</sup> | -                   | -      | -      | -                    | -      | -      | -                    | -      | 0,75-2,5                         | -      | 0,75-2,5             | -      | 0,75-2,5             | -       |
| mm <sup>2</sup> | -                   | -      | -      | -                    | -      | -      | -                    | -      | 0,75-2,5                         | -      | 0,75-2,5             | -      | 0,75-2,5             | -       |
| mm <sup>2</sup> | -                   | -      | -      | -                    | -      | -      | -                    | -      | -                                | -      | -                    | -      | -                    | -       |
| mm <sup>2</sup> | 0,75-2,5            | -      | -      | 1-2,5                | -      | -      | 1-2,5                | -      | 1-2,5                            | -      | 1-2,5                | -      | 1-2,5                | -       |
| mm <sup>2</sup> | 0,5-2,5             | -      | -      | 1-2,5                | -      | -      | 1-2,5                | -      | 1-2,5                            | -      | 1-2,5                | -      | 1-2,5                | -       |
| mm <sup>2</sup> | 0,5-1,5             | -      | -      | -                    | -      | -      | -                    | -      | -                                | -      | -                    | -      | -                    | -       |
| mm <sup>2</sup> | 2                   | -      | -      | 2                    | -      | -      | 2                    | -      | 2                                | -      | 2                    | -      | 2                    | -       |
| AWG             | -                   | -      | -      | -                    | -      | -      | -                    | -      | 16 - 12                          | -      | 16 - 12              | -      | 16 - 12              | -       |
| AWG             | -                   | -      | -      | -                    | -      | -      | -                    | -      | 16 - 12                          | -      | 16 - 12              | -      | 16 - 12              | -       |
| AWG             | 14 - 12             | -      | -      | 16 - 12              | -      | -      | 16 - 12              | -      | 16 - 12                          | -      | 16 - 12              | -      | 16 - 12              | -       |
| AWG             | 18 - 12             | -      | -      | 16 - 12              | -      | -      | 16 - 12              | -      | 16 - 12                          | -      | 16 - 12              | -      | 16 - 12              | -       |
| AWG             | 2                   | -      | -      | 2                    | -      | -      | 2                    | -      | 2                                | -      | 2                    | -      | 2                    | -       |

1) Normal or delayed drop is adjustable

Contactors, Motor-Starters  
 Circuit Breakers  
 Manual Motor-Starters  
 Switches  
 AC-Main Switches  
 DC-Switch Disconnectors  
 Push Buttons  
 Representatives, Suppliers

# Contactors

## Data according to IEC 947-4-1, EN 60947-4-1, VDE 0660

| Main Contacts  | Type               | K2-09     | K2-12      | K2-16      | K2-23     | K2-30     | K2-37       | K2-45     | K2-60      | K85        | K110       |
|--|--------------------|-----------|------------|------------|-----------|-----------|-------------|-----------|------------|------------|------------|
| <b>Rated insulation voltage <math>U_i</math></b> <sup>1)</sup>                 | V~                 | 690       | 690        | 690        | 690       | 690       | 690         | 690       | 690        | 750        | 750        |
| <b>Making capacity <math>I_{eff}</math></b> at $U_e = 690V\sim$                | A                  | 200       | 200        | 200        | 400       | 500       | 500         | 700       | 900        | 1100       | 1200       |
| <b>Breaking capacity <math>I_{eff}</math></b> 400V~                            | A                  | 180       | 180        | 200        | 380       | 400       | 400         | 600       | 800        | 950        | 1100       |
| K2-09 to K2-16 $\cos\phi = 0,65$ 500V AC                                       | A                  | 150       | 150        | 180        | 300       | 370       | 370         | 500       | 700        | 850        | 1100       |
| K2-23 to K3-1200 $\cos\phi = 0,35$ 690V AC                                     | A                  | 100       | 100        | 150        | 260       | 340       | 340         | 400       | 500        | 600        | 600        |
|  | A                  | -         | -          | -          | -         | -         | -           | -         | -          | -          | -          |
| <b>Utilization category AC1</b>  |                    |           |            |            |           |           |             |           |            |            |            |
| <b>Switching of resistive load</b>   |                    |           |            |            |           |           |             |           |            |            |            |
| Rated operational current $I_e (=I_{th})$ at 40°C, open                        | <b>A</b>           | <b>25</b> | <b>25</b>  | <b>25</b>  | <b>45</b> | <b>50</b> | <b>50</b>   | <b>80</b> | <b>100</b> | <b>150</b> | <b>170</b> |
| Rated operational power of three-phase resistive loads 50-60Hz, $\cos\phi = 1$ | 220V kW            | 9,5       | 9,5        | 9,5        | 17        | 19        | 19          | 30        | 38         | 57         | 64         |
|  | 230V kW            | 10        | 10         | 10         | 18        | 20        | 20          | 31,5      | 40         | 59         | 67         |
|  | 240V kW            | 10,5      | 10,5       | 10,5       | 18,5      | 20,5      | 20,5        | 33        | 41         | 62         | 70         |
|  | 380V kW            | 16,5      | 16,5       | 16,5       | 29,5      | 33        | 33          | 52        | 65         | 98         | 111        |
|  | 400V kW            | 17,5      | 17,5       | 17,5       | 31        | 34,5      | 34,5        | 55        | 69         | 103        | 117        |
|  | 415V kW            | 18        | 18         | 18         | 32        | 36        | 36          | 57        | 71         | 107        | 122        |
|  | 440V kW            | 19        | 19         | 19         | 34        | 38        | 38          | 61        | 76         | 114        | 129        |
|  | 500V kW            | 21,5      | 21,5       | 21,5       | 39        | 43        | 43          | 69        | 86         | 130        | 147        |
|  | 660V kW            | 28,5      | 28,5       | 28,5       | 51        | 57        | 57          | 91        | 114        | 171        | 194        |
|  | 690V kW            | 29,5      | 29,5       | 29,5       | 53,5      | 60        | 60          | 95        | 119        | 179        | 203        |
| Rated operational current $I_e (=I_{th})$ at 60°C, enclosed                    | A                  | 20        | 25         | 25         | 35        | 40        | 40          | 63        | 80         | 100        | 125        |
| Rated operational power of three-phase resistive loads 50-60Hz, $\cos\phi = 1$ | 220V kW            | 7,5       | 9,5        | 9,5        | 13        | 15        | 15          | 24        | 30         | 38         | 47         |
|  | 230V kW            | 8         | 10         | 10         | 13,5      | 16        | 16          | 25        | 31,5       | 40         | 49         |
|  | 240V kW            | 8         | 10,5       | 10,5       | 14,5      | 16,5      | 16,5        | 26        | 33         | 41         | 52         |
|  | 380V kW            | 13        | 16,5       | 16,5       | 23        | 26        | 26          | 41        | 52         | 65         | 82         |
|  | 400V kW            | 13,5      | 17,5       | 17,5       | 24        | 27,5      | 27,5        | 43        | 55         | 69         | 86         |
|  | 415V kW            | 14        | 18         | 18         | 25        | 28,5      | 28,5        | 45        | 57         | 71         | 89         |
|  | 440V kW            | 15        | 19         | 19         | 26,5      | 30        | 30          | 48        | 61         | 71         | 95         |
|  | 500V kW            | 17        | 21,5       | 21,5       | 30        | 34        | 34          | 54        | 69         | 86         | 116        |
|  | 660V kW            | 22,5      | 28,5       | 28,5       | 40        | 45        | 45          | 72        | 91         | 114        | 142        |
|  | 690V kW            | 23,5      | 29,5       | 29,5       | 42        | 48        | 48          | 75        | 95         | 119        | 149        |
| Minimum cross-section of conductor at load with $I_e (=I_{th})$                | mm <sup>2</sup>    | 4         | 4          | 4          | 10        | 10        | 10          | 25        | 35         | 50         | 70         |
| <b>Utilization category AC2 and AC3</b>  |                    |           |            |            |           |           |             |           |            |            |            |
| <b>Switching of three-phase motors</b>   |                    |           |            |            |           |           |             |           |            |            |            |
| Rated operational current $I_e$ open and enclosed                              | 220V A             | 12        | 15         | 18         | 23        | 30        | 37          | 45        | 63         | 85         | 110        |
|  | 230V A             | 11,5      | 14,5       | 17,5       | 23        | 30        | 37          | 45        | 61         | 85         | 110        |
|  | 240V A             | 11        | 14         | 17         | 23        | 30        | 37          | 45        | 60         | 85         | 110        |
|  | <b>380-400V A</b>  | <b>10</b> | <b>12</b>  | <b>16</b>  | <b>23</b> | <b>30</b> | <b>37</b>   | <b>45</b> | <b>60</b>  | <b>85</b>  | <b>110</b> |
|  | 415-440V A         | 9         | 12         | 16         | 23        | 30        | 37          | 45        | 60         | 85         | 110        |
|  | 500V A             | 9         | 12         | 16         | 23        | 30        | 30          | 45        | 55         | 85         | 110        |
|  | 660V A             | 7         | 9          | 9          | 17,5      | 21        | 21          | 33        | 42         | 60         | 60         |
|  | 690V A             | 6,5       | 8,5        | 8,5        | 17        | 20        | 20          | 31        | 40         | 58         | 58         |
| Rated operational power of three-phase motors 50-60Hz                          | 220-230V kW        | 3         | 4          | 5          | 6         | 8,5       | 11          | 12,5      | 18,5       | 25         | 33         |
|  | 240V kW            | 3         | 4          | 5          | 7         | 9         | 11,5        | 13,5      | 19         | 27         | 35         |
|  | <b>380-400V kW</b> | <b>4</b>  | <b>5,5</b> | <b>7,5</b> | <b>11</b> | <b>15</b> | <b>18,5</b> | <b>22</b> | <b>30</b>  | <b>45</b>  | <b>55</b>  |
|  | 415V kW            | 4,5       | 6          | 8,5        | 12        | 16        | 20          | 24        | 33         | 49         | 63         |
|  | 440V kW            | 4,5       | 6          | 8,5        | 12        | 16        | 20          | 24        | 33         | 49         | 63         |
|  | 500V kW            | 5,5       | 7,5        | 10         | 15        | 18,5      | 18,5        | 30        | 37         | 55         | 55         |
|  | 660-690V kW        | 5,5       | 7,5        | 7,5        | 15        | 18,5      | 18,5        | 30        | 37         | 55         | 55         |

1) Suitable at 690V for: earthed-neutral systems, overvoltage category I to IV, pollution degree 3 (standard-industry):  $U_{imp} = 8kV$ .  
Data for other conditions on request.

# Contactors

Data according to IEC 947-4-1, EN 60947-4-1, VDE 0660

| Main Contacts   | Type                    | K2-09     | K2-12      | K2-16      | K2-23     | K2-30     | K2-37       | K2-45     | K2-60     | K85       | K110      |
|---|-------------------------|-----------|------------|------------|-----------|-----------|-------------|-----------|-----------|-----------|-----------|
| <b>Utilization category AC4</b>   |                         |           |            |            |           |           |             |           |           |           |           |
| <b>Switching of squirrel cage motors, inching</b>                                 |                         |           |            |            |           |           |             |           |           |           |           |
| Rated operational current $I_e$   | 220V A                  | 12        | 15         | 16         | 23        | 30        | 37          | 45        | 63        | 85        | 98        |
| open and enclosed   | 230V A                  | 11,5      | 14,5       | 16         | 23        | 30        | 37          | 45        | 61        | 85        | 98        |
|   | 240V A                  | 11        | 14         | 16         | 23        | 30        | 37          | 45        | 60        | 85        | 98        |
|   | <b>380-400V A</b>       | <b>10</b> | <b>12</b>  | <b>16</b>  | <b>23</b> | <b>30</b> | <b>37</b>   | <b>45</b> | <b>60</b> | <b>85</b> | <b>85</b> |
|   | 415V A                  | 9         | 12         | 16         | 21        | 28        | 37          | 45        | 60        | 85        | 85        |
|   | 440V A                  | 9         | 12         | 16         | 21        | 28        | 37          | 45        | 60        | 85        | 85        |
|   | 500V A                  | 9         | 12         | 16         | 17        | 23        | 23          | 45        | 55        | 85        | 85        |
|   | 660V A                  | 7         | 9          | 9          | 13        | 17        | 17          | 33        | 42        | 60        | 60        |
|   | 690V A                  | 6,5       | 8,5        | 8,5        | 12,5      | 16,5      | 16,5        | 31        | 40        | 57,5      | 57,5      |
| Rated operational power of three-phase motors                                     | 220-230V kW             | 3         | 4          | 5          | 6         | 8,5       | 11          | 12,5      | 18,5      | 25        | 30        |
|   | 240V kW                 | 3         | 4          | 5          | 7         | 9         | 11,5        | 13,5      | 19        | 27        | 32        |
| 50-60Hz   | <b>380-400V kW</b>      | <b>4</b>  | <b>5,5</b> | <b>7,5</b> | <b>11</b> | <b>15</b> | <b>18,5</b> | <b>22</b> | <b>30</b> | <b>45</b> | <b>45</b> |
|   | 415-440V kW             | 4,5       | 6          | 8,5        | 11        | 15        | 20          | 24        | 33        | 49        | 49        |
|   | 500V kW                 | 5,5       | 7,5        | 10         | 11        | 15        | 15          | 30        | 37        | 55        | 55        |
|   | 660-690V kW             | 5,5       | 7,5        | 7,5        | 11        | 15        | 15          | 30        | 37        | 55        | 55        |
| <b>Utilization category AC5a</b>  |                         |           |            |            |           |           |             |           |           |           |           |
| <b>Switching of gas discharge lamps</b>   |                         |           |            |            |           |           |             |           |           |           |           |
| Rated operational current $I_e$ per pole at 220/230V                              |                         |           |            |            |           |           |             |           |           |           |           |
| Fluorescent lamps, uncompensated  | A                       | 20        | 20         | 20         | 35        | 40        | 40          | 65        | 85        | 100       | 120       |
| Fluorescent lamps, compensated  | A                       | 7         | 9          | 9          | 18        | 22        | 22          | 30        | 40        | 55        | 70        |
| Fluorescent lamps, dual-connection  | A                       | 22,5      | 22,5       | 22,5       | 41        | 45        | 45          | 72        | 90        | 112       | 144       |
| Metal-halide lamps <sup>1)</sup> , uncompensated                                  | A                       | 12        | 15         | 15         | 28        | 30        | 30          | 50        | 62        | 85        | 90        |
| Metal-halide lamps <sup>1)</sup> , compensated                                    | A                       | 7         | 9          | 9          | 18        | 22        | 22          | 30        | 40        | 55        | 70        |
| Mercury-vapour lamps <sup>2)</sup> , uncompensated                                | A                       | 22,5      | 25         | 25         | 41        | 45        | 45          | 72        | 90        | 112       | 144       |
| Mercury-vapour lamps <sup>2)</sup> , compensated                                  | A                       | 7         | 9          | 9          | 18        | 22        | 22          | 30        | 40        | 55        | 70        |
| Mixed light lamps <sup>3)</sup>   | A                       | 20        | 20         | 20         | 35        | 40        | 40          | 65        | 85        | 100       | 120       |
| <b>Utilization category AC5b</b>  |                         |           |            |            |           |           |             |           |           |           |           |
| <b>Switching of incandescent lamps<sup>4)</sup></b>                               |                         |           |            |            |           |           |             |           |           |           |           |
| Rated operational current $I_e$ per pole at 220/230V                              | A                       | 12,5      | 12,5       | 12,5       | 25        | 31        | 31          | 43        | 56        | 69        | 75        |
| <b>Utilization category AC6a</b>  |                         |           |            |            |           |           |             |           |           |           |           |
| <b>Transformer primary switching</b>  |                         |           |            |            |           |           |             |           |           |           |           |
| at inrush   | n                       | 30        | 30         | 30         | 30        | 30        | 30          | 30        | 30        | 30        | 30        |
| Rated operational current $I_e$   | 400V A                  | 4,5       | 5,5        | 7,5        | 10,5      | 13,5      | 13,5        | 20        | 27        | 38        | 50        |
| Rated operational power dependent on inrush n                                     | 220-230V kVA            | 1,8       | 2,2        | 3          | 4,2       | 5,4       | 5,4         | 8         | 10,7      | 15        | 20        |
|   | 240V kVA                | 1,9       | 2,3        | 3,1        | 4,3       | 5,6       | 5,6         | 8,3       | 11,2      | 15,5      | 20,5      |
|   | 380-400V kVA            | 3,1       | 3,8        | 5,2        | 7,3       | 9,3       | 9,3         | 13,5      | 18,5      | 26        | 34        |
| For different inrush-factors x use the following formula: $P_x = P_n \cdot (n/x)$ | 415-440V kVA            | 3,4       | 4,2        | 5,7        | 8         | 10,2      | 10,2        | 15        | 20,5      | 29        | 38        |
|   | 500V kVA                | 3,9       | 4,8        | 6,5        | 9         | 11,5      | 11,5        | 17        | 23        | 33        | 43        |
|   | 660-690V kVA            | 5,4       | 6,5        | 9          | 12,5      | 16        | 16          | 24        | 32        | 45        | 60        |
| <b>Utilization category DC1</b>   |                         |           |            |            |           |           |             |           |           |           |           |
| <b>Switching of resistive load</b>  |                         |           |            |            |           |           |             |           |           |           |           |
| Time constant $L/R \leq 1ms$  | 1 pole 24V A            | 20        | 25         | 25         | 45        | 50        | 50          | 80        | 100       | 150       | 170       |
| Rated operational current $I_e$   | 60V A                   | 20        | 25         | 25         | 45        | 50        | 50          | 80        | 100       | 150       | 170       |
|   | 110V A                  | 6         | 6          | 6          | 10        | 10        | 10          | 12        | 12        | 20        | 25        |
|   | 220V A                  | 0,8       | 0,8        | 0,8        | 1,4       | 1,4       | 1,4         | 1,4       | 1,4       | 2         | 2,5       |
|   | 2 poles in series 24V A |           |            |            | 45        | 50        | 50          |           |           |           |           |
|   | 60V A                   |           |            |            | 45        | 50        | 50          |           |           |           |           |
|   | 110V A                  |           |            |            | 45        | 50        | 50          |           |           |           |           |
|   | 220V A                  |           |            |            | 10        | 10        | 10          |           |           |           |           |
|   | 3 poles in series 24V A | 20        | 25         | 25         | 45        | 50        | 50          | 80        | 100       | 150       | 170       |
|   | 60V A                   | 20        | 25         | 25         | 45        | 50        | 50          | 80        | 100       | 150       | 170       |
|   | 110V A                  | 20        | 25         | 25         | 45        | 50        | 50          | 80        | 100       | 150       | 170       |
|   | 220V A                  | 16        | 20         | 20         | 30        | 35        | 35          | 63        | 80        | 100       | 160       |

1) Metal halide lamps and sodium-vapour lamps (high- and low-pressure lamps)

2) High-pressure lamps

3) Blended lamps, containing a mercury high-pressure unit and a tungsten helix in a fluorescent glass bulb (daylight lamps)

4) Current inrush approx.  $16 \times I_e$

5) With central compensation pay attention to the current inrush (capacitor switching contactors)



# Contactors

## Data according to IEC 947-4-1, EN 60947-4-1, VDE 0660

| Main Contacts   |                                   |                     | Type | K2-09                          | K2-12 | K2-16 | K2-23             | K2-30 | K2-37 | K2-45                | K2-60 | K85                   | K110 |
|---|-----------------------------------|---------------------|------|--------------------------------|-------|-------|-------------------|-------|-------|----------------------|-------|-----------------------|------|
| <b>Utilization category DC3 and DC5</b>   |                                   |                     |      |                                |       |       |                   |       |       |                      |       |                       |      |
| <b>Switching of shunt motors and series motors</b>  |                                   |                     |      |                                |       |       |                   |       |       |                      |       |                       |      |
| Time constant L/R ≤15ms   | 1 pole                            | 24V                 | A    | 20                             | 25    | 25    | 45                | 50    | 50    | 80                   | 100   | 150                   | 170  |
| Rated operational current I <sub>e</sub>  |                                   | 60V                 | A    | 6                              | 6     | 6     | 30                | 30    | 30    | 60                   | 60    | 85                    | 110  |
|   |                                   | 110V                | A    | 1,2                            | 1,2   | 1,2   | 1,8               | 1,8   | 1,8   | 1,8                  | 1,8   | 2                     | 2,5  |
|   |                                   | 220V                | A    | 0,2                            | 0,2   | 0,2   | 0,2               | 0,2   | 0,2   | 0,25                 | 0,25  | 0,5                   | 0,5  |
|   |                                   | 2 poles in series   | 24V  | A                              |       |       |                   | 45    | 50    | 50                   |       |                       |      |
|   |                                   | 60V                 | A    |                                |       |       | 45                | 50    | 50    |                      |       |                       |      |
|   |                                   | 110V                | A    |                                |       |       | 30                | 30    | 30    |                      |       |                       |      |
|   |                                   | 220V                | A    |                                |       |       | 1,8               | 1,8   | 1,8   |                      |       |                       |      |
|   | 3 poles in series                 | 24V                 | A    | 20                             | 25    | 25    | 45                | 50    | 50    | 80                   | 100   | 150                   | 170  |
|   |                                   | 60V                 | A    | 20                             | 25    | 25    | 40                | 40    | 40    | 80                   | 80    | 100                   | 110  |
|   |                                   | 110V                | A    | 20                             | 20    | 20    | 40                | 40    | 40    | 80                   | 80    | 100                   | 110  |
|   |                                   | 220V                | A    | 2,5                            | 2,5   | 2,5   | 4                 | 4     | 4     | 5                    | 5     | 7                     | 8    |
| <b>Maximum ambient temperature</b>  |                                   |                     |      |                                |       |       |                   |       |       |                      |       |                       |      |
| Operation   | open                              | °C                  |      |                                |       |       |                   |       |       |                      |       |                       |      |
|   | enclosed                          | °C                  |      | -40 to +60 (+90) <sup>1)</sup> |       |       |                   |       |       |                      |       |                       |      |
| with thermal overload relay   | open                              | °C                  |      | -40 to +40                     |       |       |                   |       |       |                      |       |                       |      |
|   | enclosed                          | °C                  |      | -25 to +60                     |       |       |                   |       |       |                      |       |                       |      |
|   |                                   | °C                  |      | -25 to +40                     |       |       |                   |       |       |                      |       |                       |      |
| Storage   |                                   | °C                  |      | -50 to +90                     |       |       |                   |       |       |                      |       |                       |      |
| <b>Short circuit protection</b>   |                                   |                     |      |                                |       |       |                   |       |       |                      |       |                       |      |
| for contactors without thermal overload relay   |                                   |                     |      |                                |       |       |                   |       |       |                      |       |                       |      |
| Coordination-type "1" according to IEC 947-4-1  |                                   |                     |      |                                |       |       |                   |       |       |                      |       |                       |      |
| Contact welding without hazard of persons   |                                   |                     |      |                                |       |       |                   |       |       |                      |       |                       |      |
| max. fuse size  | gL (gG)                           | A                   |      | 63                             | 63    | 63    | 80                | 80    | 80    | 160                  | 160   | 250                   | 250  |
| Coordination-type "2" according to IEC 947-4-1  |                                   |                     |      |                                |       |       |                   |       |       |                      |       |                       |      |
| Light contact welding accepted  |                                   |                     |      |                                |       |       |                   |       |       |                      |       |                       |      |
| max. fuse size  | gL (gG)                           | A                   |      | 25                             | 35    | 35    | 50                | 50    | 50    | 100                  | 125   | 160                   | 200  |
| Contact welding not accepted  |                                   |                     |      |                                |       |       |                   |       |       |                      |       |                       |      |
| max. fuse size  | gL (gG)                           | A                   |      | 16                             | 16    | 16    | 25                | 35    | 35    | 50                   | 63    | 100                   | 125  |
| For contactors with thermal overload relay the device with the smaller admissible backup fuse (contactor or thermal overload relay) determines the fuse size. |                                   |                     |      |                                |       |       |                   |       |       |                      |       |                       |      |
| <b>Cable cross-sections</b>   |                                   |                     |      |                                |       |       |                   |       |       |                      |       |                       |      |
| for contactors without thermal overload relay   |                                   |                     |      |                                |       |       |                   |       |       |                      |       |                       |      |
| main connector  | solid or stranded                 | mm <sup>2</sup>     |      | 0,75 - 4                       |       |       | 1,5-10 + 1,5-6    |       |       | 4 - 35 <sup>2)</sup> |       | 10 - 70 <sup>2)</sup> |      |
|   | flexible                          | mm <sup>2</sup>     |      | 0,75 - 2,5                     |       |       | 1,5-6 + 1,5-4     |       |       | 6 - 25 <sup>2)</sup> |       | 10 - 70 <sup>2)</sup> |      |
| Cables per clamp  | flexible with multicore cable end | mm <sup>2</sup>     |      | 0,5 - 2,5                      |       |       | 1,5-6 + 1,5-4     |       |       | 4 - 25               |       | 10 - 35               |      |
|   |                                   |                     |      | 2                              |       |       | 1+1               |       |       | 1                    |       | 1                     |      |
| main connector  | solid                             | AWG                 |      | 14 - 10                        |       |       | 14 - 10 + 14 - 10 |       |       | 10                   |       | 10                    |      |
|   | flexible                          | AWG                 |      | 18 - 10                        |       |       | 14 - 8 + 14 - 10  |       |       | 10 - 2               |       | 6 - 0                 |      |
| Cables per clamp  |                                   |                     |      | 2                              |       |       | 1+1               |       |       | 1                    |       | 1                     |      |
| <b>Frequency of operations z</b>  |                                   |                     |      |                                |       |       |                   |       |       |                      |       |                       |      |
| Contactors without thermal overload relay   |                                   |                     |      |                                |       |       |                   |       |       |                      |       |                       |      |
|   | without load                      | 1/h                 |      | 10000                          |       |       | 7000              |       |       | 7000                 |       | 3000                  |      |
|   | AC3, I <sub>e</sub>               | 1/h                 |      | 600                            |       |       | 600               |       |       | 400                  |       | 300                   |      |
|   | AC4, I <sub>e</sub>               | 1/h                 |      | 120                            |       |       | 120               |       |       | 120                  |       | 120                   |      |
|   | DC3, I <sub>e</sub>               | 1/h                 |      | 600                            |       |       | 600               |       |       | 400                  |       | 300                   |      |
| <b>Mechanical life</b>  |                                   |                     |      |                                |       |       |                   |       |       |                      |       |                       |      |
| AC operated   |                                   | S x 10 <sup>6</sup> |      | 10                             |       |       | 10                |       |       | 10                   |       | 5                     |      |
| DC operated with economy resistor   |                                   | S x 10 <sup>6</sup> |      | 10                             |       |       | 10                |       |       | 10                   |       | 5                     |      |
| <b>Short time current</b>   |                                   |                     |      |                                |       |       |                   |       |       |                      |       |                       |      |
|   | 10s-current                       | A                   |      | 96                             | 120   | 144   | 184               | 240   | 296   | 360                  | 504   | 680                   | 880  |
| <b>Power loss per pole</b>  |                                   |                     |      |                                |       |       |                   |       |       |                      |       |                       |      |
|   | at I <sub>e</sub> /AC3 400V       | W                   |      | 0,21                           | 0,26  | 0,4   | 0,63              | 1,1   | 1,7   | 1,8                  | 3,6   | 4,3                   | 6,0  |
| <b>Resistance to shock acc. to IEC 68-2-27</b>  |                                   |                     |      |                                |       |       |                   |       |       |                      |       |                       |      |
| Shock time 20ms sine-wave   | NO                                | g                   |      | 10                             | 10    | 10    | 8                 | 8     | 8     | 8                    | 8     | 7                     | 7    |
|   | NC                                | g                   |      | 6                              | 6     | 6     | 5                 | 5     | 5     | -                    | -     | 5                     | 5    |

1) With reduced control voltage range 0,9 up to 1,0 x U<sub>s</sub> and with reduced rated current I<sub>e</sub> /AC1 according to I<sub>e</sub> /AC3

2) Maximum cable cross-section with prepared conductor

# Contactors

Data according to IEC 947-4-1, EN 60947-4-1, VDE 0660

| Auxiliary Contacts  | Type  | K2-09 | K2-12    | K2-16 | K2-23 | K2-30    | K2-37 | K2-45    | K2-60 | K85      | K110     |
|---|---|-------|----------|-------|-------|----------|-------|----------|-------|----------|----------|
| <b>Rated insulation voltage <math>U_i</math> <sup>1)</sup></b>  | V AC  |       | 690      |       |       | 690      |       |          | -     |          | 690      |
| <b>Thermal rated current <math>I_{th}</math> to 690V</b>  |   |       |          |       |       |          |       |          |       |          |          |
| Ambient temperature   | 40°C A  |       | 16       |       |       | 16       |       |          | -     |          | 16       |
|   | 60°C A  |       | 12       |       |       | 12       |       |          | -     |          | 12       |
| <b>Utilization category AC15</b>  |   |       |          |       |       |          |       |          |       |          |          |
| Rated operational current $I_e$   | 220-240V A  |       | 12       |       |       | 12       |       |          | -     |          | 12       |
|   | 380-415V A  |       | 4        |       |       | 4        |       |          | -     |          | 6        |
|   | 440V A  |       | 4        |       |       | 4        |       |          | -     |          | 6        |
|   | 500V A  |       | 3        |       |       | 3        |       |          | -     |          | 4        |
|   | 660-690V A  |       | 1        |       |       | 1        |       |          | -     |          | 2        |
| <b>Utilization category DC13</b>  |   |       |          |       |       |          |       |          |       |          |          |
| Rated operational current $I_e$   | 60V A   |       | 8        |       |       | 8        |       |          | -     |          | 8        |
|   | 110V A  |       | 1        |       |       | 1        |       |          | -     |          | 1        |
|   | 220V A  |       | 0,1      |       |       | 0,1      |       |          | -     |          | 0,1      |
| <b>Short circuit protection</b><br>short-circuit current 1kA,<br>contact welding not accepted<br>max. fuse size gL (gG) A<br>For contactors with thermal overload relay the<br>device with the smaller admissible control fuse<br>(contactor or thermal overload relay)<br>determines the fuse. |   |       | 25       |       |       | -        |       |          | -     |          | 25       |
| <b>Control Circuit</b>  |   |       |          |       |       |          |       |          |       |          |          |
| <b>Power consumption of coils</b>   |   |       |          |       |       |          |       |          |       |          |          |
| AC operated   | inrush VA   |       | 33-45    |       |       | 90-115   |       | 140-165  |       | 280-350  | 350-420  |
|   | sealed VA   |       | 7-10     |       |       | 9-13     |       | 13-18    |       | 16-23    | 23-29    |
|   | W   |       | 2,6-3    |       |       | 2,7-4    |       | 5,4-7    |       | 4-6      | 6-7,3    |
| DC operated   | inrush W  |       | 75       |       |       | 140      |       | 200      |       | 170      | 320      |
| with economic circuit   | sealed W  |       | 2        |       |       | 2        |       | 6        |       | 2        | 4        |
| <b>Operation range of coils</b><br>in multiples of control voltage $U_s$  |   |       |          |       |       |          |       |          |       |          |          |
|   | AC operated                                       |       | 0,85-1,1 |       |       | 0,85-1,1 |       | 0,85-1,1 |       | 0,85-1,1 | 0,85-1,1 |
|   | DC operated                                       |       | 0,8-1,1  |       |       | 0,8-1,1  |       | 0,8-1,1  |       | 0,8-1,1  | 0,8-1,1  |
| <b>Switching time</b> at control voltage $U_s \pm 10\%$ <sup>2) 3)</sup>  |   |       |          |       |       |          |       |          |       |          |          |
| AC operated   | make time ms                                      |       | 8-16     |       |       | 10-25    |       | 12-28    |       | 13-30    | 13-30    |
|   | release time ms                                   |       | 5-13     |       |       | 8-15     |       | 8-15     |       | 8-15     | 8-15     |
|   | arc duration ms                                   |       | 10-15    |       |       | 10-15    |       | 10-15    |       | 10-15    | 10-15    |
| DC operated   | make time ms                                      |       | 8-12     |       |       | 10-20    |       | 12-23    |       | 20-30    | 20-30    |
| with AC magnet system   | release time ms                                   |       | 8-13     |       |       | 10-15    |       | 10-18    |       | 10-18    | 10-18    |
|   | arc duration ms                                   |       | 10-15    |       |       | 10-15    |       | 10-15    |       | 10-15    | 10-15    |
| <b>Cable cross-section</b>  |   |       |          |       |       |          |       |          |       |          |          |
| Auxiliary connector   | solid mm <sup>2</sup>                             |       | 0,75-4   |       |       | -        |       | -        |       | 0,75-2,5 | 0,75-2,5 |
|   | flexible mm <sup>2</sup>                          |       | 0,75-2,5 |       |       | -        |       | -        |       | 0,75-2,5 | 0,75-2,5 |
|   | flexible with multicore cable end mm <sup>2</sup> |       | 0,5-2,5  |       |       | -        |       | -        |       | 0,5-1,5  | 0,5-1,5  |
| Magnet coil   | solid mm <sup>2</sup>                             |       | 0,75-2,5 |       |       | 0,75-2,5 |       | 0,75-2,5 |       | 0,75-2,5 | 0,75-2,5 |
|   | flexible mm <sup>2</sup>                          |       | 0,5-2,5  |       |       | 0,5-2,5  |       | 0,5-2,5  |       | 0,5-2,5  | 0,5-2,5  |
|   | flexible with multicore cable end mm <sup>2</sup> |       | 0,5-1,5  |       |       | 0,5-1,5  |       | 0,5-1,5  |       | 0,5-1,5  | 0,5-1,5  |
| Clamps per pole   |   |       | 2        |       |       | 2        |       | 2        |       | 2        | 2        |

1) Suitable for: earthed-neutral systems, overvoltage category I to IV, pollution degree 3 (standard-industry):  $U_{imp} = 8kV$ . Data for other conditions on request

2) Total breaking time = release time + arc duration

3) Values for delay of the release time of the make contact and the make time of the break contact will be increased, if magnet coils are protected against voltage peaks (varistor, RC-unit, diode-unit)

# Contactors for North America

## Data according to UL508

| Main Contacts (cULus)  |  | Type        | K(G)3-10 | K(G)3-14 | K(G)3-18 | K(G)3-22 | K(G)3-24 | K(G)3-32 | K(G)3-40 | K3-50   | K3-62   | K3-74   |
|--|--|-------------|----------|----------|----------|----------|----------|----------|----------|---------|---------|---------|
| Rated operational current "General Use"                                      |  | A           | 25       | 25       | 30       | 30       | 50       | 65       | 80       | 110     | 120     | 130     |
| <b>Motor DOL 3-phase</b> at 60Hz   |  |             |          |          |          |          |          |          |          |         |         |         |
| Rated operational current  |  | 600V A      | 10       | 14       | 18       | 22       | 22       | 27       | 34       | 44      | 52      | 66      |
| Rated operational power  |  | 110-120V hp | 1½       | 2        | 2        | 3        | 5        | 5        | 7½       | 10      | 10      | 10      |
|  |  | 200V hp     | 3        | 3        | 5        | 5        | 7½       | 10       | 10       | 15      | 20      | 25      |
|  |  | 220-240V hp | 3        | 3        | 7½       | 7½       | 10       | 10       | 15       | 20      | 25      | 30      |
|  |  | 277V hp     | 3        | 5        | 7½       | 7½       | 7½       | 10       | 15       | 20      | 25      | 30      |
|  |  | 380-415V hp | 5        | 5        | 10       | 10       | 10       | 15       | 20       | 25      | 30      | 40      |
|  |  | 440-480V hp | 5        | 7½       | 10       | 15       | 15       | 20       | 25       | 30      | 40      | 50      |
|  |  | 550-600V hp | 7½       | 10       | 15       | 20       | 20       | 25       | 30       | 40      | 50      | 50      |
| <b>Motor DOL 1-phase</b> at 60Hz   |  |             |          |          |          |          |          |          |          |         |         |         |
| Rated operational current  |  | 600V A      | 10       | 14       | 18       | 22       | 22       | 27       | 34       | 44      | 52      | 66      |
| Rated operational power of AC motors at 60Hz (1ph)                           |  | 110-120V hp | ½        | ¾        | 1        | 1½       | 1½       | 2        | 3        | 3       | 5       | 7½      |
|  |  | 200V hp     | 1        | 1,5      | 2        | 3        | 3        | 5        | 7½       | 7½      | 10      | 15      |
|  |  | 220-240V hp | 1½       | 2        | 3        | 3        | 5        | 5        | 7½       | 10      | 15      | 15      |
|  |  | 277V hp     | 2        | 3        | 3        | 5        | 5        | 7½       | 10       | 10      | 15      | 15      |
|  |  | 380-415V hp | 3        | 3        | 5        | 5        | 5        | 7½       | 10       | 15      | 20      | 20      |
|  |  | 440-480V hp | 3        | 5        | 5        | 7½       | 7½       | 10       | 15       | 20      | 25      | 25      |
|  |  | 550-600V hp | 3        | 5        | 7½       | 10       | 10       | 15       | 20       | 25      | 30      | 30      |
| <b>Motor DOL 3-phase</b> according to ANSI A17.5                             |  |             |          |          |          |          |          |          |          |         |         |         |
| Rated operational current  |  | 600V A      | -        | -        | -        | -        | 15       | 22       | -        | 27      | 37      | -       |
| Rated operational power of 3-phase motors for elevators (500.000 operations) |  | 110-120V hp | -        | -        | -        | -        | 2        | 3        | -        | 3       | 5       | -       |
|  |  | 200V hp     | -        | -        | -        | -        | 3        | 5        | -        | 7½      | 10      | -       |
|  |  | 220-240V hp | -        | -        | -        | -        | 5        | 7½       | -        | 7½      | 10      | -       |
|  |  | 440-480V hp | -        | -        | -        | -        | 10       | 15       | -        | 20      | 25      | -       |
|  |  | 550-600V hp | -        | -        | -        | -        | 10       | 20       | -        | 25      | 30      | -       |
| Rated current 2 series contacts  |  | 600V A      | -        | -        | -        | -        | 22       | 27       | -        | 44      | 52      | 66      |
| Fuse Class RK5 / Short-circuit current                                       |  | A/kA        | 50/5     | 50/5     | 70/5     | 90/5     | 90/5     | 125/5    | 175/5    | 200/5   | 250/5   | 300/5   |
| Fuse Class T / Short-circuit current   |  | A/kA        | 45/100   | 50/100   | 70/100   | 90/100   | 110/100  | 150/100  | 150/100  | 175/100 | 175/100 | 175/100 |
| Rated voltage  |  | V           | 600      | 600      | 600      | 600      | 600      | 600      | 600      | 600     | 600     | 600     |
| <b>Auxiliary Contacts (cULus)</b>  |  |             | A600     | A600     | A600     | A600     | -        | -        | -        | -       | -       | -       |

| Main Contacts (cULus)                   |  | Type        | K2-09 | K2-12 | K2-16 | K2-23 | K2-30 | K2-45 | K2-60 | K85  | K110  |
|---|--|-------------|-------|-------|-------|-------|-------|-------|-------|------|-------|
| Rated operational current "General Use" |  | A           | 25    | 25    | 25    | 40    | 40    | 72    | 90    | 125  | 150   |
| <b>Motor DOL 3-phase</b> at 60Hz        |  |             |       |       |       |       |       |       |       |      |       |
| Rated operational power                 |  | 110-120V hp | 1½    | 2     | 2     | 3     | 5     | -     | -     | 15   | -     |
|   |  | 200V hp     | 2     | 3     | 3     | 5     | 7½    | 10    | 15    | -    | 30    |
|   |  | 220-240V hp | 3     | 3     | 5     | 7½    | 10    | 15    | 20    | 35   | 40    |
|   |  | 440-480V hp | 5     | 7½    | 10    | 15    | 20    | 30    | 40    | 65   | 75    |
|   |  | 550-600V hp | 7½    | 10    | 15    | 20    | 25    | 40    | 50    | 85   | 100   |
| <b>Motor DOL 1-phase</b> at 60Hz        |  |             |       |       |       |       |       |       |       |      |       |
| Rated operational power                 |  | 110-120V hp | ½     | ¾     | 1     | 1½    | 2     | 3     | 5     | 8    | 10    |
|   |  | 200V hp     | 1     | 2     | 2     | 3     | 3     | 5     | 7½    | -    | 20    |
|   |  | 220-240V hp | 1½    | 2     | 3     | 3     | 5     | 7½    | 10    | 20   | 20    |
| Fuse / Short-circuit current            |  | A/kA        | 30/5  | 40/5  | 50/5  | 60/5  | 110/5 | 175/5 | 175/5 | -    | 300/5 |
| Rated voltage                           |  | V           | 600   | 600   | 600   | 600   | 600   | 600   | 600   | 600  | 600   |
| <b>Auxiliary Contacts (cULus)</b>       |  |             | A600  | A600  | A600  | A600  | A600  | -     | -     | A600 | A600  |

# Contactors for North America

## Data according to UL508

| Type | K3-90                 | K3-115                | K3-116 | K3-151 | K3-176 | K3-210 | K3-260 | K3-316 | K3-450  | K3-550  | K3-700  | K3-860  | K3-1000 | K3-1200 |
|------|-----------------------|-----------------------|--------|--------|--------|--------|--------|--------|---------|---------|---------|---------|---------|---------|
| A    | 160                   | 200                   | 150    | 180    | 220    | 250    | 300    | 350    | 420     | 520     | 700     | 810     | -       | 1215    |
| A    | 85                    | 99                    |        | 125    | 150    | 190    | 240    | 300    | 300     | 400     | 550     | 700     | -       | 1000    |
| hp   | 15                    | 20                    | -      | -      | -      | -      | -      | -      | -       | -       | -       | -       | -       | -       |
| hp   | 25                    | 35                    | 30     | 40     | 50     | 60     | 75     | 100    | 125     | 150     | 200     | 250     | -       | 450     |
| hp   | 35                    | 40                    | 40     | 50     | 60     | 75     | 100    | 125    | 125     | 150     | 250     | 300     | -       | 450     |
| hp   | -                     | -                     | -      | -      | -      | -      | -      | -      | -       | -       | -       | -       | -       | -       |
| hp   | 50                    | 60                    | -      | -      | -      | -      | -      | -      | -       | -       | -       | -       | -       | -       |
| hp   | 65                    | 75                    | 75     | 100    | 125    | 150    | 200    | 250    | 250     | 350     | 500     | 600     | -       | 900     |
| hp   | 85                    | 100                   | 100    | 125    | 150    | 200    | 250    | 300    | 250     | 350     | 500     | 600     | -       | 900     |
| A    | 86                    | 103                   |        | 125    | 150    | -      | -      | -      | -       | -       | -       | -       | -       | -       |
| hp   | 8                     | 10                    | 10     | 15     | 25     | -      | -      | -      | -       | -       | -       | -       | -       | -       |
| hp   | 15                    | 20                    | 20     | -      | -      | -      | -      | -      | -       | -       | -       | -       | -       | -       |
| hp   | 20                    | 25                    | -      | 25     | 30     | 40     | 50     | 50     | -       | -       | -       | -       | -       | -       |
| hp   | 20                    | 25                    | -      | -      | -      | -      | -      | -      | -       | -       | -       | -       | -       | -       |
| hp   | 30                    | 40                    | -      | -      | -      | -      | -      | -      | -       | -       | -       | -       | -       | -       |
| hp   | 40                    | 50                    | -      | -      | -      | -      | -      | -      | -       | -       | -       | -       | -       | -       |
| hp   | 50                    | 60                    | -      | -      | -      | -      | -      | -      | -       | -       | -       | -       | -       | -       |
| A    | -                     | -                     | -      | -      | -      | -      | -      | -      | -       | -       | -       | -       | -       | -       |
| hp   | -                     | -                     | -      | -      | -      | -      | -      | -      | -       | -       | -       | -       | -       | -       |
| hp   | -                     | -                     | -      | -      | -      | -      | -      | -      | -       | -       | -       | -       | -       | -       |
| hp   | -                     | -                     | -      | -      | -      | -      | -      | -      | -       | -       | -       | -       | -       | -       |
| hp   | -                     | -                     | -      | -      | -      | -      | -      | -      | -       | -       | -       | -       | -       | -       |
| A    | -                     | -                     | -      | -      | -      | -      | -      | -      | -       | -       | -       | -       | -       | -       |
| A/kA | 300/10                | 300/10                | 225/10 | 300/10 | 350/10 | 400/18 | 500/18 | 500/18 | 1200/18 | 1200/18 | 2000/30 | 2000/30 | -       | 2000/42 |
| A/kA | 300/100 <sup>3)</sup> | 300/100 <sup>3)</sup> | -      | -      | -      | -      | -      | -      | -       | -       | -       | -       | -       | -       |
| V    | 600                   | 600                   | 600    | 600    | 600    | 600    | 600    | 600    | 600     | 600     | 600     | 600     | -       | 600     |
|      | -                     | -                     | -      | -      | -      | -      | -      | -      | A600    | A600    | A600    | A600    | -       | A600    |

| Main Contacts (cULus)  | Type     | K3-18NK | K3-18NBK | K3-24K  | K3-32K  | K3-50K   | K3-62K  | K3-74K              | K3-90K                | K3-115K               |                      |
|--|----------|---------|----------|---------|---------|----------|---------|---------------------|-----------------------|-----------------------|----------------------|
| Rated operational power of<br>3-phase cap. banks 110-120V<br>at 60Hz (3ph) | 200V     | kVAr    | 0-3,5    | 0-3,5   | 3-5,5   | 3-7      | 6,5-10  | 6,5-15              | 6,5-18 <sup>1)</sup>  | 10-24                 | 10-28 <sup>2)</sup>  |
|  | 220-240V | kVAr    | 0-6      | 0-6     | 4,5-10  | 4,5-12,5 | 10-16,7 | 10-25               | 10-32 <sup>1)</sup>   | 17-40                 | 17-46 <sup>2)</sup>  |
|  |          | kVAr    | 0-7      | 0-7     | 5,5-11  | 5,5-15   | 12,5-20 | 12,5-30             | 12,5-36 <sup>1)</sup> | 20-47                 | 20-56 <sup>2)</sup>  |
|  | 440-480V | kVAr    | 0-15     | 0-15    | 11,5-25 | 11,5-30  | 25-40   | 25-60               | 25-72 <sup>1)</sup>   | 40-95                 | 40-114 <sup>2)</sup> |
| 550-600V   | kVAr     | 0-18    | 0-18     | 14,5-30 | 14,5-35 | 31-50    | 31-75   | 31-90 <sup>1)</sup> | 50-120                | 50-143 <sup>2)</sup>  |                      |
| Fuse Class RK5 /<br>Short-circuit current                                  | A/kA     | 70/5    | 70/5     | 90/5    | 125/5   | 200/5    | 250/5   | 300/5               | 300/10                | 300/10                |                      |
| Fuse Class T /<br>Short-circuit current                                    | A/kA     | 80/100  | 80/100   | 110/100 | 150/100 | 175/100  | 175/100 | 175/100             | 300/100 <sup>3)</sup> | 300/100 <sup>3)</sup> |                      |
| Rated voltage  | V        | 600     | 600      | 600     | 600     | 600      | 600     | 600                 | 600                   | 600                   |                      |
| <b>Auxiliary Contacts (cULus)</b>  |          | A600    | A600     | -       | -       | -        | -       | -                   | -                     | -                     |                      |

1) Consider the max. thermal current of the contactor K3-74A: I<sub>th</sub> 130A

2) Consider the min. cross-section of conductor at max. load

3) Class T and Class RK1

# Contactors

## Data according to IEC 947-4-1, EN 60947-4-1, VDE 0660

### Contact Life

For selection of the suitable contactor-type according to supply voltage, power rating and application (utilization category AC1, AC3 or AC4) use contact life characteristic diagram.

For the most common supply voltages four scales of power ratings  $P_n$  are provided for each utilization category.

Select contactor-type according to utilization category **AC3** (breaking current  $I_a = I_e$ ) using the **motor rating** scales to the right, according to utilization category **AC4** (breaking current  $I_a = 6 \times I_e$ ) using the **motor rating** scales to the left. <sup>1)</sup>

Select contactor-type according to utilization category **AC1** (breaking current  $I_a = I_e/AC1$ ) using the **breaking current** scale. <sup>1)</sup>

For contactors frequently used under AC3/AC4-mixed service conditions calculate contact life with the formula:

$$M = \frac{AC3}{1 + \frac{\%AC4}{100} \times \left( \frac{AC3}{AC4} - 1 \right)}$$

M = Contact life (switching cycles) for AC3/AC4-mixed operations  
 AC3 = Contact life (switching cycles) for AC3 operations (normal switching conditions). Breaking current  $I_a =$  rated motor current  $I_e$ .  
 AC4 = Contact life (switching cycles) for AC4 operations (inching). Breaking current  $I_a =$  multiples of rated motor current  $I_e$ .  
 %AC4 = Percents of AC4-operations related to the total cycles.

### Motor Rating

#### $P_n = AC4$

660/ 500V 380/ 220/  
690V 400V 230V

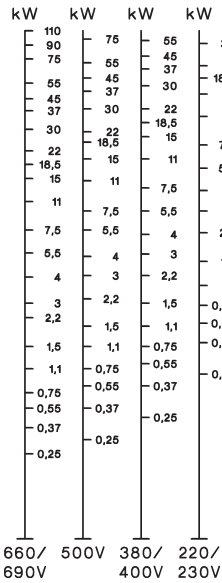

### Motor Rating

#### $P_n = AC3$

660/ 500V 380/ 220/  
690V 400V 230V

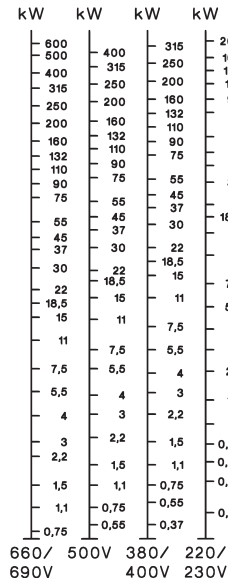

### Breaking Current

#### $I_a (= I_e = AC1)$

A

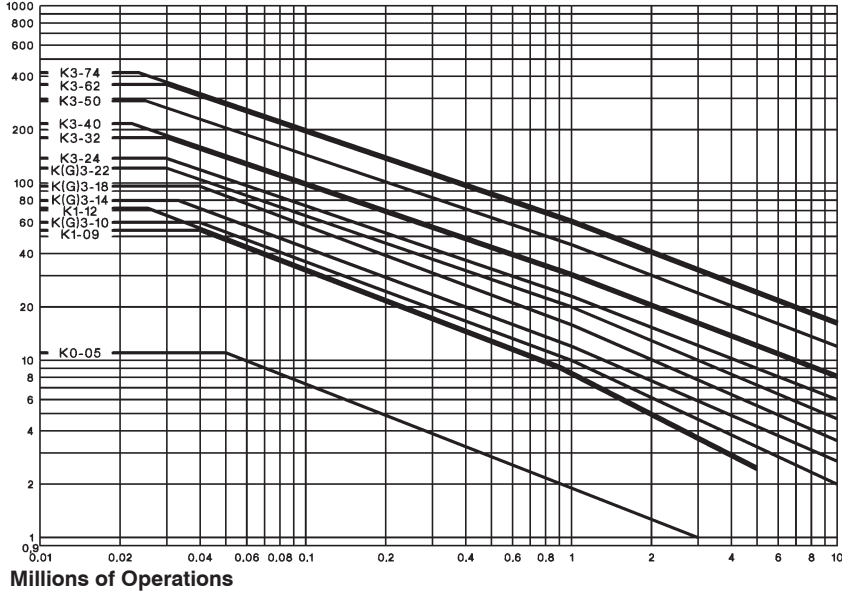

### Motor Rating

#### $P_n = AC4$

660/ 500V 380/ 220/  
690V 400V 230V

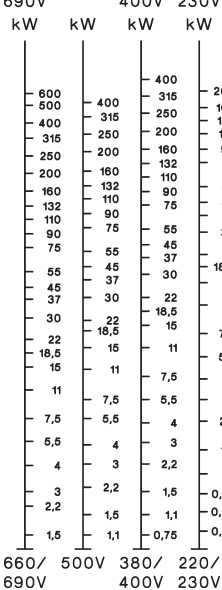

### Motor Rating

#### $P_n = AC3$

660/ 500V 380/ 220/  
690V 400V 230V

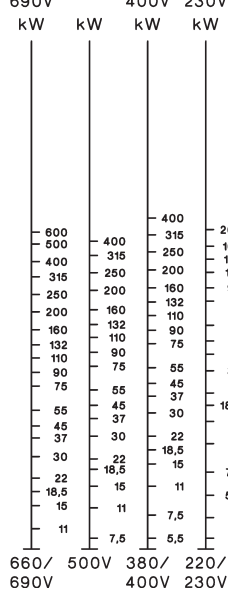

### Breaking Current

#### $I_a (= I_e = AC1)$

A

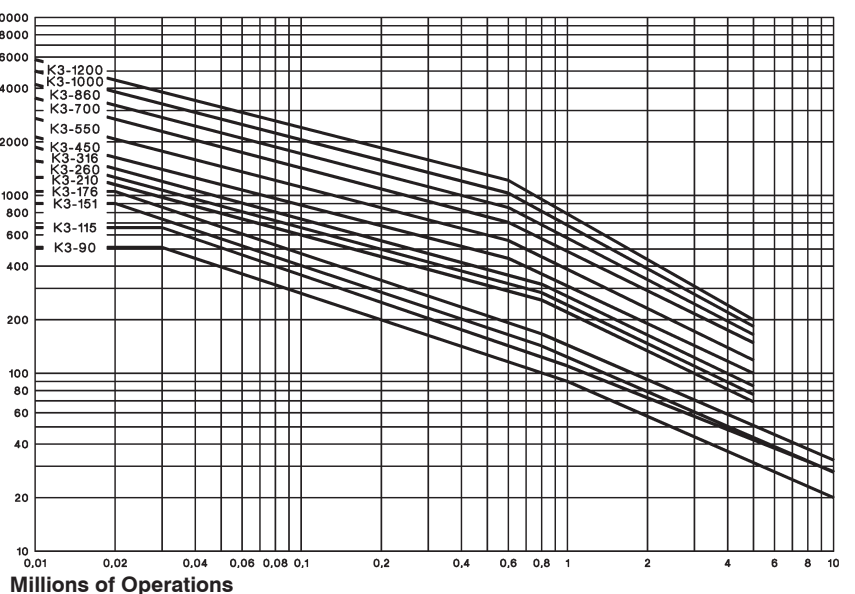

1) Pay attention to the approved rated values of the selected contactor according to the national approvals

# Contactors

## Utilization Categories

For easier choice of devices and in order to make the comparison of different products simpler are utilization categories for contactors and motor-starters according to IEC 947-4-1 and VDE 0660 Part

102, for control circuit devices and switching elements according to IEC 947-5-1 and VDE 0660 Part 200 determined. The table offers different utilization categories, typical applications and assorted test conditions.

| Type of current     | Category                                      | Typical applications  | Rated operational current                  | Test conditions for the number of on-load operating cycles |             |                      |             |                      |                      | Test conditions for making and breaking capacities |                      |                      |                |                      |                      |
|---------------------|---|---|--|--|-------------|----------------------|-------------|----------------------|----------------------|--|----------------------|----------------------|----------------|----------------------|----------------------|
|                     |   |   |  | Make   |             |                      | Break       |                      |                      | Make   |                      |                      | Break          |                      |                      |
|                     |   |   |  | $I/I_e$  | $U/U_e$     | cosφ                 | $I_c/I_e$   | $U_c/U_e$            | cosφ                 | $I/I_e$  | $U/U_e$              | cosφ                 | $I_c/I_e$      | $U_c/U_e$            | cosφ                 |
| Alternating Current | <b>AC1</b>                                    | Non-inductive or slightly inductive loads<br>resistance furnaces                                  | all values                                 | 1  | 1           | 0,95                 | 1           | 1                    | 0,95                 | 1,5  | 1,05                 | 0,8                  | 1,5            | 1,05                 | 0,8                  |
|                     | <b>AC2</b>                                    | Slip-ring motors:<br>starting, switching off  | all values                                 | 2,5  | 1           | 0,65                 | 2,5         | 1                    | 0,65                 | 4  | 1,05                 | 0,65                 | 4              | 1,05                 | 0,65                 |
|                     | <b>AC3</b>                                    | Squirrel-cage motors:<br>starting, switching off<br>motors during running                         | $I_e < 17A$<br>$I_e > 17A$<br>$I_e > 100A$ | 6<br>6<br>6  | 1<br>1<br>1 | 0,65<br>0,35<br>0,35 | 1<br>1<br>1 | 0,17<br>0,17<br>0,17 | 0,65<br>0,35<br>0,35 | 10<br>10<br>10                                     | 1,05<br>1,05<br>1,05 | 0,45<br>0,45<br>0,35 | 8<br>8<br>8    | 1,05<br>1,05<br>1,05 | 0,45<br>0,45<br>0,35 |
|                     | <b>AC4</b>                                    | Squirrel-cage motors:<br>starting, plugging,<br>inching   | $I_e < 17A$<br>$I_e > 17A$<br>$I_e > 100A$ | 6<br>6<br>6  | 1<br>1<br>1 | 0,65<br>0,35<br>0,35 | 6<br>6<br>6 | 1<br>1<br>1          | 0,65<br>0,35<br>0,35 | 12<br>12<br>12                                     | 1,05<br>1,05<br>1,05 | 0,45<br>0,45<br>0,35 | 10<br>10<br>10 | 1,05<br>1,05<br>1,05 | 0,45<br>0,45<br>0,35 |
|                     | <b>AC5a</b>                                   | Switching of electric<br>discharge lamp controls  | all values                                 | -  | -           | -                    | -           | -                    | -                    | 3  | 1,05                 | 0,45                 | 3              | 1,05                 | 0,45                 |
|                     | <b>AC5b</b>                                   | Switching of<br>incandescent lamps  | all values                                 | -  | -           | -                    | -           | -                    | -                    | 1,5  | 1,05                 | <sup>1)</sup>        | 4              | 1,05                 | <sup>1)</sup>        |
|                     | <b>AC6a</b>                                   | Switching of<br>transformers  | $I_e < 100A$<br>$I_e > 100A$               | -  | -           | -                    | -           | -                    | -                    | 4,5<br>4,5   | 1,05<br>1,05         | 0,45<br>0,35         | 3,6<br>3,6     | 1,05<br>1,05         | 0,45<br>0,35         |
|                     | <b>AC6b</b>                                   | Switching of<br>capacitors  | -  | -  | -           | -                    | -           | -                    | -                    | <sup>2)</sup>                                      |                      |                      | <sup>2)</sup>  |                      |                      |
|                     | <b>AC7a</b>                                   | Slightly inductive loads<br>in household appliances<br>and similar applications                   | all values                                 | -  | -           | -                    | -           | -                    | -                    | 1,5  | 1,05                 | 0,8                  | 1,5            | 1,05                 | 0,8                  |
|                     | <b>AC7b</b>                                   | Motor loads<br>for household applications   | $I_e < 100A$<br>$I_e > 100A$               | -  | -           | -                    | -           | -                    | -                    | 8<br>8   | 1,05<br>1,05         | 0,45<br>0,35         | 6<br>6         | 1,05<br>1,05         | 0,45<br>0,35         |
|                     | <b>AC8a</b>                                   | Hermetic refrigerant compressor<br>motor control with manual<br>resetting of overload releases    | $I_e < 100A$<br>$I_e > 100A$               | -  | -           | -                    | -           | -                    | -                    | 6<br>6   | 1,05<br>1,05         | 0,45<br>0,35         | 6<br>6         | 1,05<br>1,05         | 0,45<br>0,35         |
|                     | <b>AC8b</b>                                   | Hermetic refrigerant compressor<br>motor control with automatic<br>resetting of overload releases | $I_e < 100A$<br>$I_e > 100A$               | -  | -           | -                    | -           | -                    | -                    | 6<br>6   | 1,05<br>1,05         | 0,45<br>0,35         | 6<br>6         | 1,05<br>1,05         | 0,45<br>0,35         |
|                     | <b>AC12</b>                                   | Control of resistive loads and<br>solid state loads with<br>isolation by opto couplers            | all values                                 | -  | -           | -                    | -           | -                    | -                    | 1  | 1                    | 0,9                  | 1              | 1                    | 0,9                  |
|                     | <b>AC13</b>                                   | Control of<br>solid state loads with<br>transformer isolation                                     | all values                                 | -  | -           | -                    | -           | -                    | -                    | 10   | 1,1                  | 0,65                 | 1,1            | 1,1                  | 0,65                 |
|                     | <b>AC14</b>                                   | Control of<br>small electromagnetic loads<br>(≤72VA)  | -  | -  | -           | -                    | -           | -                    | -                    | 6  | 1,1                  | 0,7                  | 6              | 1,1                  | 0,7                  |
| <b>AC15</b>         | Control of<br>electromagnetic load<br>(>72VA) | -   | 10   | 1  | 0,7         | 1                    | 1           | 0,4                  | 10                   | 1,1  | 0,3                  | 10                   | 1,1            | 0,3                  |                      |
| Direct Current      | <b>DC1</b>                                    | Non-inductive or<br>slightly inductive loads<br>resistance furnaces                               | all values                                 | 1  | 1           | 1                    | 1           | 1                    | 1                    | 1,5  | 1,05                 | 1                    | 1,5            | 1,05                 | 1                    |
|                     | <b>DC3</b>                                    | Shunt-motors:<br>starting, plugging, inching<br>dynamic braking of d.c. motors                    | all values                                 | 2,5  | 1           | 2                    | 2,5         | 1                    | 2                    | 4  | 1,05                 | 2,5                  | 4              | 1,05                 | 2,5                  |
|                     | <b>DC5</b>                                    | Series-motors:<br>starting, plugging, inching<br>dynamic braking of d.c. motors                   | all values                                 | 2,5  | 1           | 7,5                  | 2,5         | 1                    | 7,5                  | 4  | 1,05                 | 15                   | 4              | 1,05                 | 15                   |
|                     | <b>DC6</b>                                    | Switching of<br>incandescent lamps  | all values                                 | -  | -           | -                    | -           | -                    | -                    | 1,5  | 1,05                 | <sup>1)</sup>        | 4              | 1,05                 | <sup>1)</sup>        |
|                     | <b>DC12</b>                                   | Control of resistive loads and<br>solid state loads with<br>isolation by opto couplers            | all values                                 | -  | -           | -                    | -           | -                    | -                    | 1  | 1                    | 1                    | 1              | 1                    | 1                    |
|                     | <b>DC13</b>                                   | Control of<br>electromagnets  | all values                                 | 1  | 1           | ≤300                 | 1           | 1                    | ≤300                 | 1,1  | 1,1                  | ≤300                 | 1,1            | 1,1                  | ≤300                 |
|                     | <b>DC14</b>                                   | Control of<br>electromagnetic loads having<br>economy resistors in circuit                        | all values                                 | -  | -           | -                    | -           | -                    | -                    | 10   | 1,1                  | 15                   | 10             | 1,1                  | 15                   |

1) Test with incandescent lamps

2) Test conditions according to standard

## Accessories

### Data according to IEC 947-5-1, EN 60947-5-1, VDE 0660

| Type   |                 | HN              | HTN      | HA       | HB       | HKT<br>HKA | HKF<br>HKB | K2-DK<br>K2-SK | K2-TP    | K2-L <sup>2)</sup> |     |
|--|-----------------|-----------------|----------|----------|----------|------------|------------|----------------|----------|--------------------|-----|
| <b>Rated insulation voltage <math>U_i</math></b> <sup>1)</sup>   | V AC            | 690             | 690      | 690      | 690      | 690        | 690        | 690            | 690      | 690                |     |
| <b>Thermal rated current <math>I_{th}</math></b> to bis 690V<br>Ambient temperature  | max. 40°C       | A               | 10       | 10       | 25       | 10         | 10         | 16             | 26       | 10                 | 10  |
|  | max. 60°C       | A               | 6        | 6        | 20       | 6          | -          | -              | -        | -                  | 6   |
| <b>Frequency of operations z</b>   | 1/h             | 3000            | -        | 3000     | 3000     | -          | -          | -              | 1200     | 3000               |     |
| <b>Mechanical life</b>   | $S \times 10^6$ | 10              | 10       | 10       | 10       | -          | -          | -              | 1        | 10                 |     |
| <b>Power loss</b> per pole at $I_e/AC1$  | W               | 0,5             | 0,5      | 1,5      | 0,5      | -          | -          | -              | -        | -                  |     |
| <b>Utilization category AC15</b>   |                 |                 |          |          |          |            |            |                |          |                    |     |
| Rated operational current $I_e$  | 220-240V        | A               | 3        | 3        | 6        | 3          | 3          | 3              | -        | 4                  | 3   |
|  | 380-400V        | A               | 2        | 2        | 3        | 2          | 2          | 2              | -        | 3                  | 2   |
|  | 440V            | A               | 1,6      | 1,6      | 2        | 1,6        | 1,5        | 1,5            | -        | 2                  | 1,6 |
|  | 500V            | A               | 1,2      | 1,2      | 2        | 1,2        | 1,5        | 1,5            | -        | 2                  | 1   |
|  | 660-690V        | A               | 0,6      | 0,6      | 1        | 0,6        | 1          | 1              | -        | 2                  | 0,5 |
| <b>Utilization category DC13</b>   |                 |                 |          |          |          |            |            |                |          |                    |     |
| Rated operational current $I_e$  | 60V             | A               | 2        | 2        | 8        | 2          | -          | -              | -        | 2,5                | 2   |
|  | 110V            | A               | 0,4      | 0,4      | 1        | 0,4        | 0,5        | 0,5            | -        | 1,5                | 0,4 |
|  | 220V            | A               | 0,1      | 0,1      | 0,1      | 0,1        | 0,2        | 0,2            | -        | 0,2                | 0,1 |
| <b>Short circuit protection</b><br>short-circuit current 1kA,<br>contact welding not accepted<br>max. fuse size gL (gG) A  |                 |                 |          |          |          |            |            |                |          |                    |     |
|  |                 | 20              | 20       | 25       | 20       | 10         | 10         | -              | 10       | 10                 |     |
| For contactors with thermal overload relay or auxiliary contacts the device with the smaller admissible control fuse (contactor or thermal overload relay) determines the fuse size. |                 |                 |          |          |          |            |            |                |          |                    |     |
| <b>Cable cross-sections</b>  |                 |                 |          |          |          |            |            |                |          |                    |     |
| solid or stranded  | mm <sup>2</sup> | 0,75-2,5        | 0,75-2,5 | 0,75-2,5 | 0,75-2,5 | 0,75-2,5   | 0,75-2,5   | 0,75-2,5       | 1-2,5    | 0,75-2,5           |     |
|  | flexible        | mm <sup>2</sup> | 0,75-2,5 | 0,75-2,5 | 0,75-2,5 | 0,75-2,5   | 0,75-2,5   | 0,75-2,5       | 0,75-2,5 | 0,75-2,5           |     |
| flexible with multicore cable end  | mm <sup>2</sup> | 0,5-1,5         | 0,5-1,5  | 0,5-1,5  | 0,5-1,5  | 0,5-1,5    | 0,5-1,5    | 0,5-1,5        | 0,75-2,5 | 0,5-1,5            |     |
|  | solid           | AWG             | 14 - 12  | 14 - 12  | 14 - 12  | 14 - 12    | 14 - 12    | 14 - 12        | 14 - 12  | 14 - 12            |     |
|  | flexible        | AWG             | 18 - 12  | 18 - 12  | 18 - 12  | 18 - 12    | 18 - 12    | 18 - 12        | 18 - 12  | 18 - 12            |     |
| Cables per clamp   |                 |                 | 2        | 2        | 2        | 2          | 2          | 2              | 2        | 2                  |     |

### Data according to CSA, UL and CUL

| Type                      |           | HN   | HTN  | HA   | HB.. | HKA, HKT<br>HKF | K2-DK<br>K2-SK | K2-TP | K2-L <sup>2)</sup> |
|---------------------------|-----------|------|------|------|------|-----------------|----------------|-------|--------------------|
| Rated operational current | A         | 10   | 10   | 16   | 10   | 10              | -              | 10    | -                  |
| "General Use"             |           |      |      |      |      |                 |                |       |                    |
| Rated operational voltage | max. V AC | 600  | 600  | 600  | 600  | 600             | -              | 600   | 600                |
| <b>Auxiliary Contacts</b> |           | A600 | A600 | A600 | A600 | A600            | -              | A600  | Intermittent duty  |

1) Suitable for: earthed-neutral systems, overvoltage category I to IV, pollution degree 3 (standard-industry):  $U_{imp} = 8kV$ . Data for other conditions on request.

2) Command duration min. 30ms, 10% duty cycle, max. 30 sec.

# Contactors and Accessories

## Wiring diagrams

### Auxiliary contact blocks

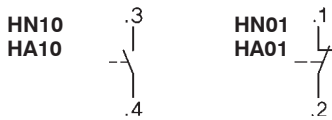

### Snap-on momentary contact blocks

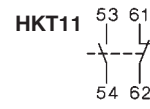
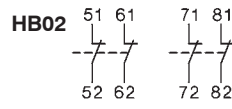
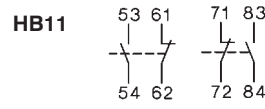
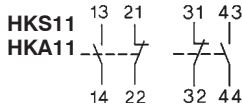
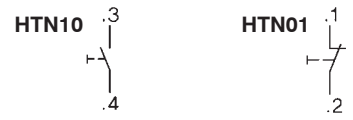

HB11, HB02:  
Correct terminal marking  
is given by mounting.

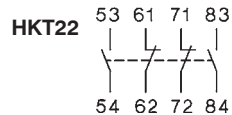
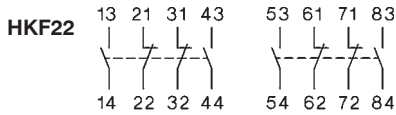

### Indicator units

#### Electronic timer

##### K3-T180 240

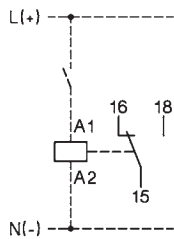

#### Coil current indicator

##### K2-ING K2-INR

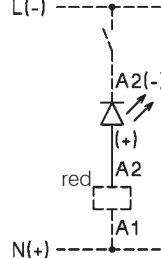

#### Voltage indicator

##### K2-UN K2-UNR

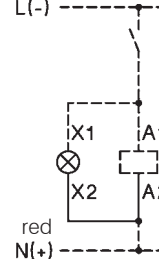

#### Latch

##### K2-L..

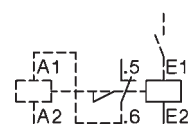

#### Fuse holder

##### K2-F



with rectifier

##### K2-RF1 K2-RF3

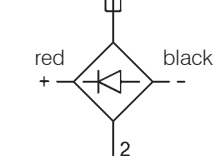

Colours mentioned in  
wiring diagram refer to  
the outgoing  
connection wires  
of the device.

#### Interface

##### K2-IM

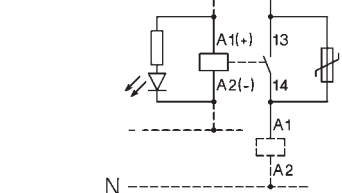

### Regulation of switch position of aux. contact block HKF22 for contactors K3-450 to K3-860

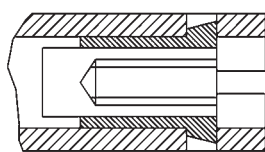
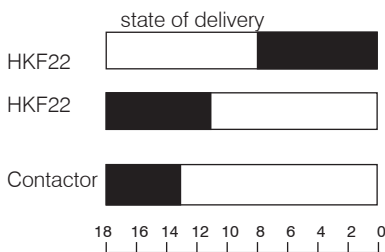

Standard position of regulation screw

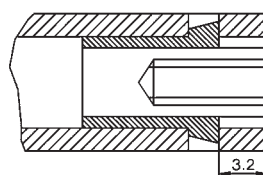
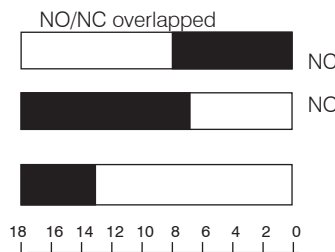

Regulation screw position (unscrew by 4 turns)

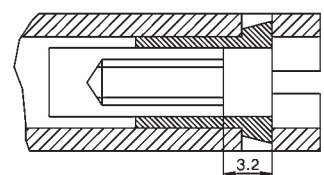
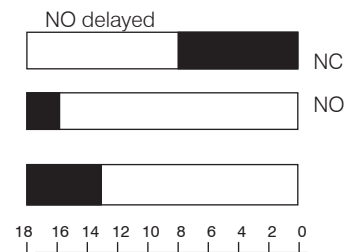

Regulation screw position (screw by 4 turns)



# Contactors

## Dimensions

### AC operated

K3-10N..  
K3-14N..  
K3-18N..  
K3-22N..

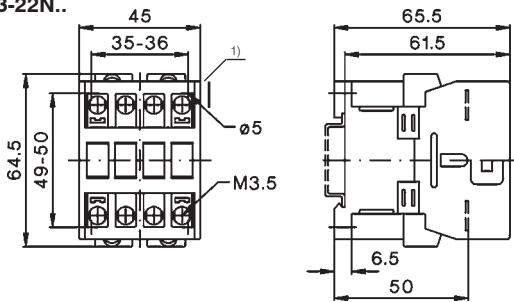

K3-24..  
K3-32..  
K3-40..

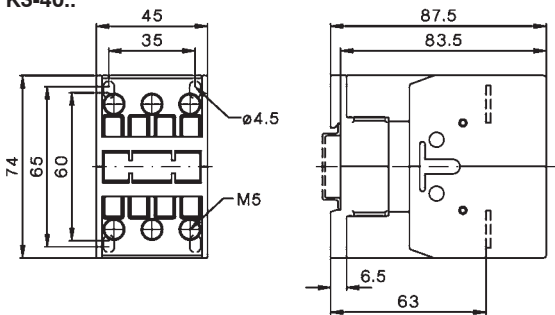

K3-50..  
K3-62..  
K3-74..

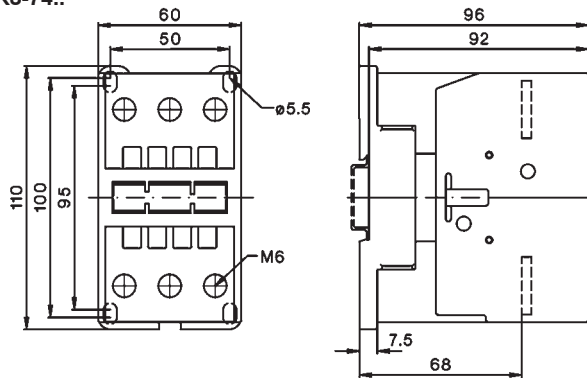

### AC and DC operated

K3-90..  
K3-115..

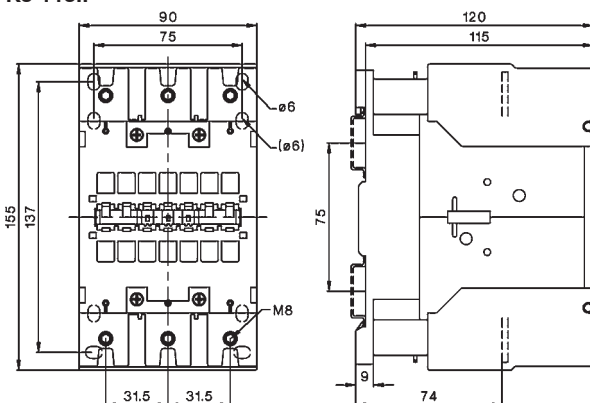

### DC operated

KG3-10..  
KG3-14..  
KG3-18..  
KG3-22..

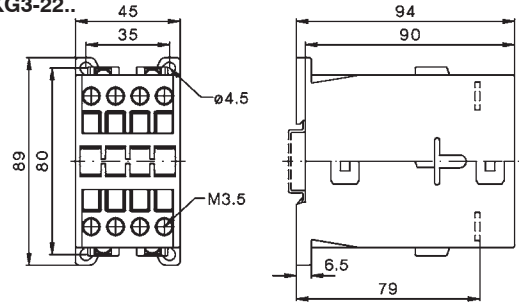

KG3-24..  
KG3-32..  
KG3-40..

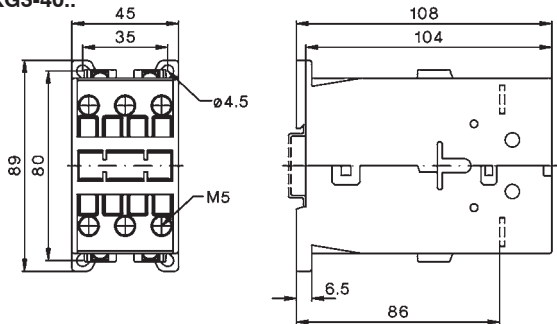

K3-50..=  
K3-62..=  
K3-74..=

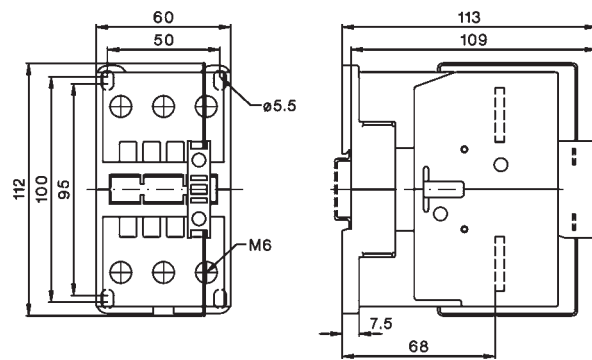

1) Minimum side distance to  
conductive parts for coil voltage:  
500V  $U_{imp}=6kV$  2mm  
660-690V  $U_{imp}=8kV$  4,5mm

# Contactors

Dimensions, AC operated, DC operated

K3-151..  
K3-176..

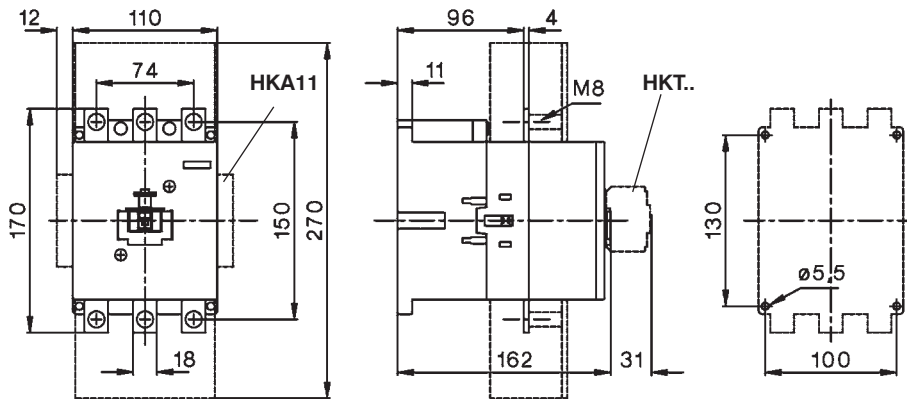

K3-210..  
K3-260..  
K3-316..

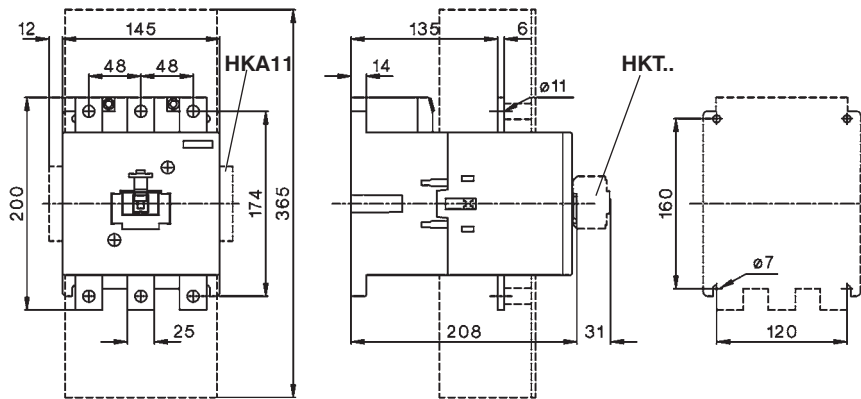

K3-450..  
K3-550..

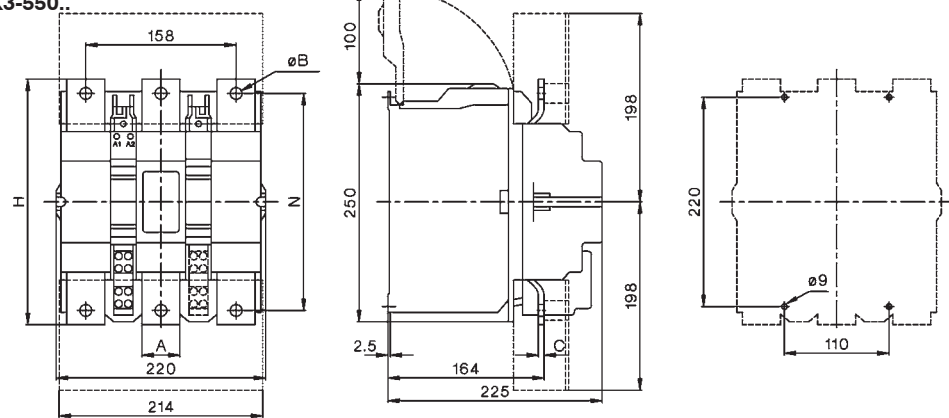

| Type   | A  | B    | C | H   | N   |
|--------|----|------|---|-----|-----|
| K3-450 | 40 | 10,5 | 4 | 233 | 206 |
| K3-550 | 40 | 12,5 | 6 | 258 | 228 |

K3-700..  
K3-860..

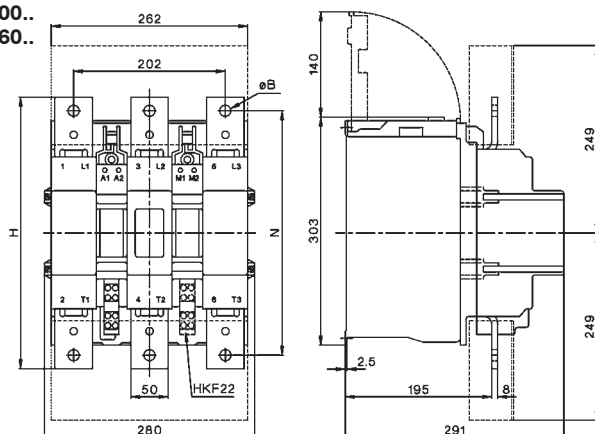

| Type   | B  | H   | N   |
|--------|----|-----|-----|
| K3-700 | 13 | 310 | 277 |
| K3-860 | 15 | 361 | 325 |

# Contactors

## Dimensions

AC operated, DC operated

K3-1000..

K3-1200..

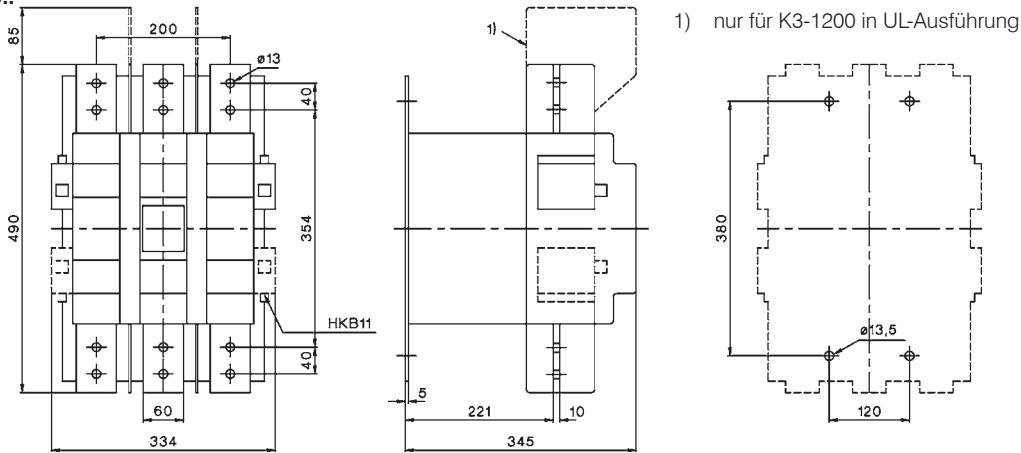

Capacitor Switching Contactors, AC operated

K3-18NK..

K3-18NBK..

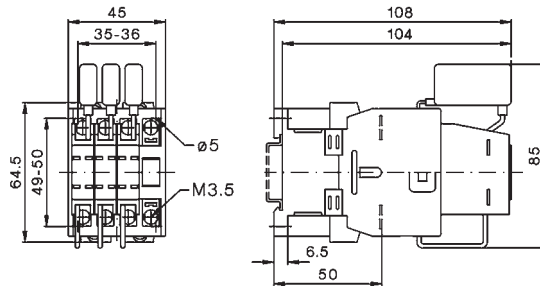
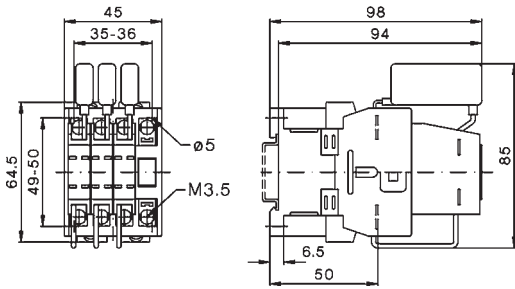

K3-24K..  
K3-32K..

K3-50K..  
K3-62K..  
K3-74K..

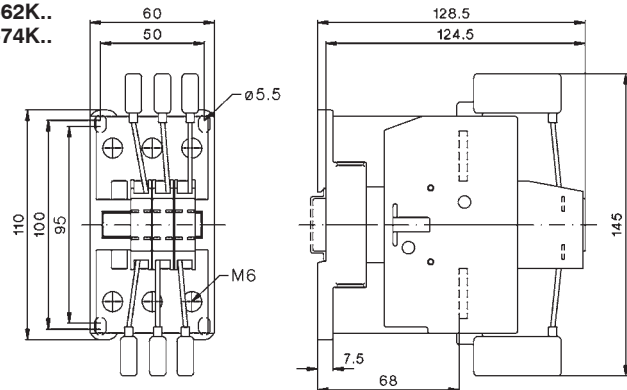
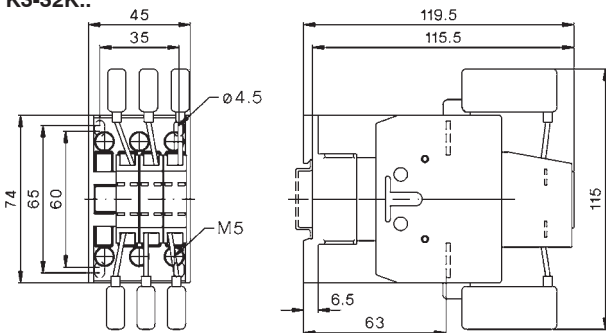

K3-90K..  
K3-115K..

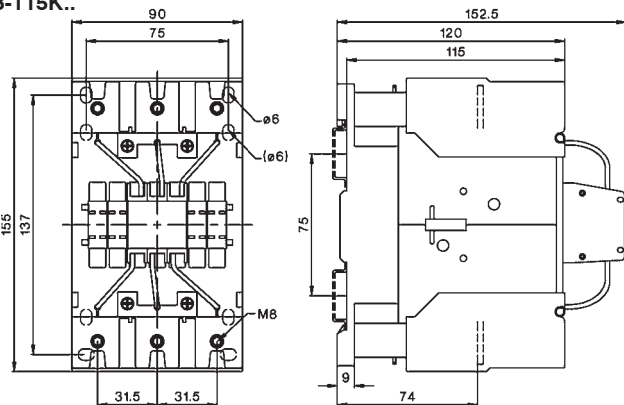

# Contactors

## Dimensions

### Contactors DC operated

- K3-10N..=
- K3-14N..=
- K3-18N..=
- K3-22N..=

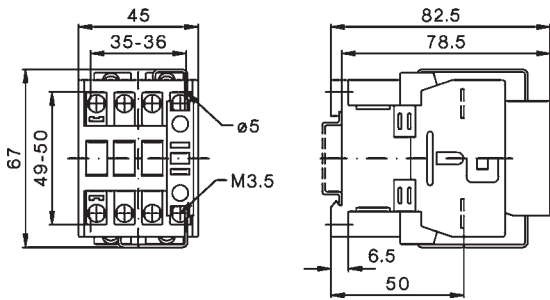

- K3-24..=
- K3-32..=
- K3-40..=

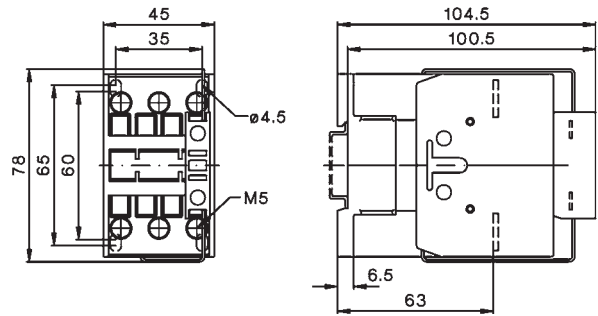

### Contactors 4-pole, AC operated / DC operated

- K3-10NA00-40
- K3-14NA00-40
- K3-18NA00-40
- K3-22NA00-40

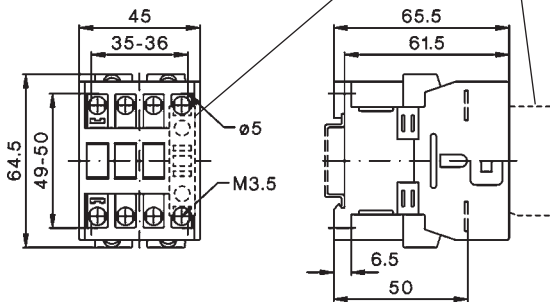

- K2-23A00-40
- K2-30A00-40
- K2-37A00-40

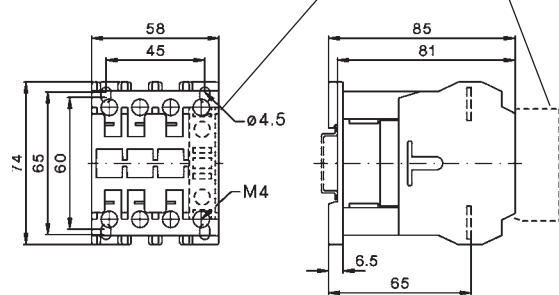

### Contactors 4-pole, AC operated / DC operated

- K2-45A00-40
- K2-60A00-40

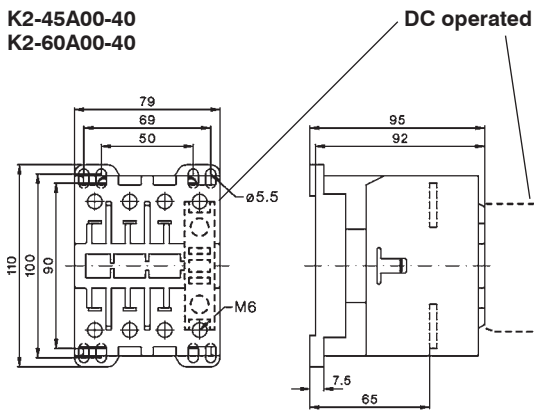

- K3-41A00-40

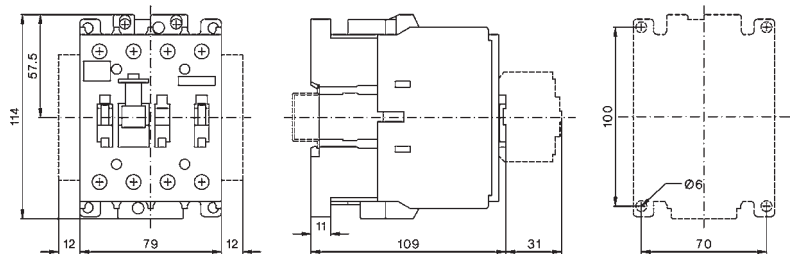

- K3-96A00-40

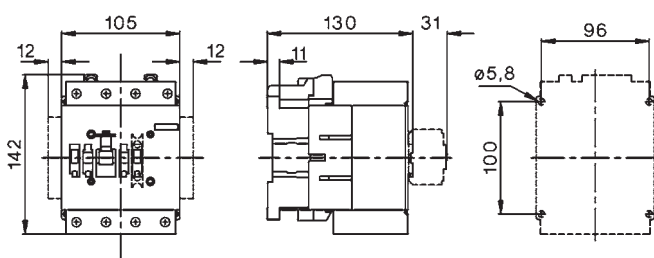

- K3-116A00-40
- K3-151A00-40
- K3-176A00-40

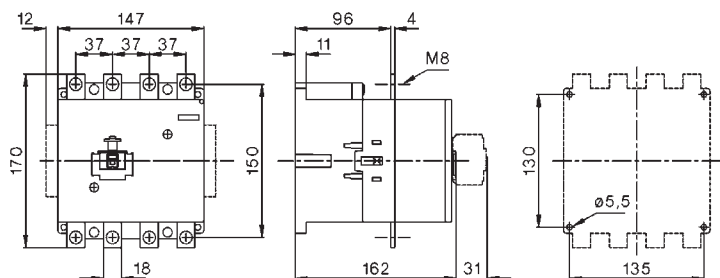

# Contactors

Contactors 4-pole, AC and DC operated

K3-210A00-40

K3-260A00-40

K3-316A00-40

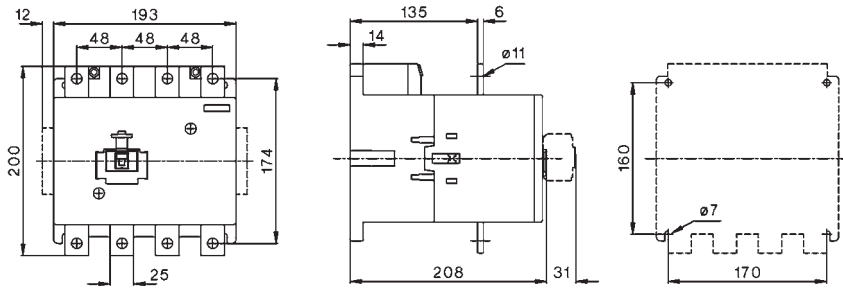

## Dimensions Accessories

Aux. cont. blocks, terminal blocks

Snap-on momentary cont. blocks

Auxiliary contact blocks

HN10, HN01

K2-SK, K2-DK

HTN10, HTN01

HA10, HA01

HB11, HB02

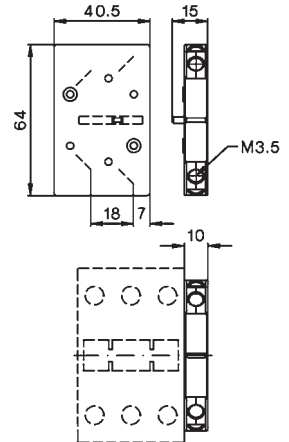
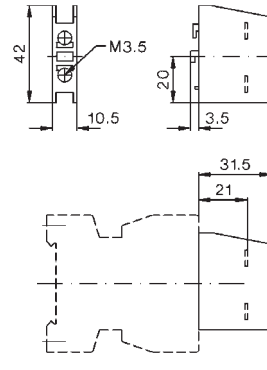
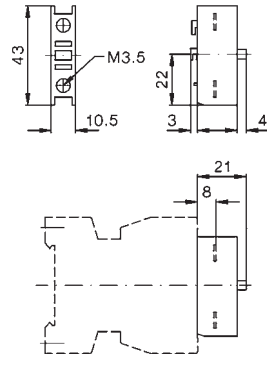
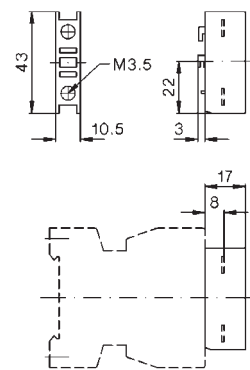

## 4. pole for contactors K3-200 to K3-1200

| Type   | A   | B   | C  | D   | E   | F | G   | H   |
|--------|-----|-----|----|-----|-----|---|-----|-----|
| NP175  | 223 | 148 | 26 | 52  | 98  | 5 | 122 | M8  |
| NP350  | 223 | 148 | 26 | 52  | 98  | 5 | 122 | M8  |
| NP325  | 262 | 148 | 26 | 55  | 116 | 5 | 122 | M10 |
| NP500  | 294 | 220 | 53 | 72  | 138 | 5 | 152 | M12 |
| NP760  | 294 | 220 | 53 | 72  | 138 | 5 | 152 | M12 |
| NP501  | 348 | 220 | 53 | 73  | 145 | 5 | 152 | M12 |
| NP1000 | 348 | 220 | 53 | 73  | 145 | 8 | 152 | M12 |
| NP1001 | 410 | 220 | 53 | 110 | 157 | 8 | 152 | M12 |

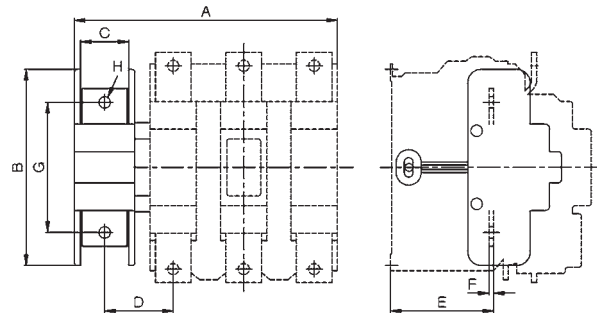

## Electronic timer

K3-T180 240

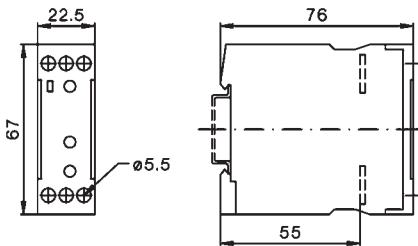

## Electronic timer on-delay

K2-TE..

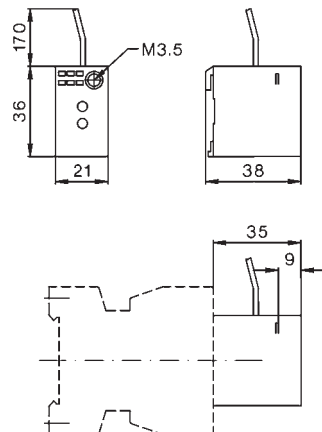

# Contactors

## Dimensions Accessories

### Mechanical interlocks

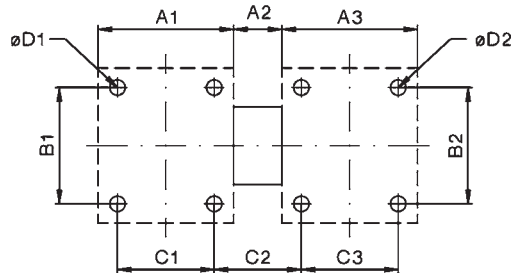

| Type            | Contactor 1        | Contactor 2        | A1  | A2 | A3  | B1  | B2  | C1  | C2    | C3  | D1   | D2   |                  |
|-----------------|--------------------|--------------------|-----|----|-----|-----|-----|-----|-------|-----|------|------|------------------|
| <b>LG10889</b>  | K3-07 to K3-40     | K3-07 to K3-40     | 45  | 7  | 45  | 50  | 50  | 35  | 17    | 35  | 4,5  | 4,5  |                  |
| <b>LG10889</b>  | KG3-07 to KG3-22   | KG3-07 to KG3-22   | 45  | 7  | 45  | 80  | 50  | 35  | 17    | 35  | 4,5  | 4,5  |                  |
| <b>LG10889</b>  | KG3-24 to KG3-40   | KG3-22 to KG3-40   | 45  | 7  | 45  | 80  | 50  | 35  | 17    | 35  | 4,5  | 4,5  |                  |
| <b>LG10890</b>  | K3-50 to K3-74     | K3-24 to K3-40     | 60  | 12 | 55  | 100 | 65  | 50  | 22    | 45  | 5,5  | 4,5  |                  |
| <b>LG10890</b>  | K3-50 to K3-74     | K3-50 to K3-74     | 60  | 12 | 60  | 100 | 100 | 50  | 22    | 50  | 5,5  | 5,5  |                  |
| <b>LG11478</b>  | K3-90 to K3-115    | K3-90 to K3-115    | 90  | 12 | 90  | 100 | 100 | 75  | 27    | 75  | 5,5  | 5,5  |                  |
| <b>LG8511</b>   | K65 - K110         | K65 - K110         | 90  | 12 | 90  | 100 | 100 | 75  | 27    | 75  | 6    | 6    |                  |
| <b>LG11223H</b> | K3-151, -176       | K3-151, -176       | 110 | 30 | 110 | 130 | 130 | 100 | 40    | 100 | 6    | 6    | 3-pole contactor |
| <b>LG11223H</b> | K3-116, -151, -176 | K3-116, -151, -176 | 147 | 30 | 147 | 130 | 130 | 135 | 42    | 135 | 6    | 6    | 4-pole contactor |
| <b>LG11223H</b> | K3-210, -260, -316 | K3-210, -260, -316 | 145 | 30 | 145 | 160 | 160 | 120 | 55    | 120 | 6    | 6    | 3-pole contactor |
| <b>LG11223H</b> | K3-210, -260, -316 | K3-210, -260, -316 | 193 | 30 | 193 | 160 | 160 | 170 | 55    | 170 | 6    | 6    | 4-pole contactor |
| <b>LG10400H</b> | K3-450, K3-550     | K3-450, K3-550     | 220 | 42 | 220 | 220 | 220 | 110 | 152   | 110 | 9    | 9    |                  |
| <b>LG10402H</b> | K3-700, -860       | K3-700, -860       | 280 | 32 | 280 | 280 | 280 | 175 | 137   | 175 | 11   | 11   |                  |
| <b>LG10403H</b> | K3-1000, -1200     | K3-1000, -1200     | 334 | 46 | 334 | 380 | 380 | 120 | 260   | 120 | 13,5 | 13,5 |                  |
| <b>LG10399H</b> | K3-450, -550       | K3-700, -860       | 220 | 37 | 280 | 220 | 280 | 110 | 144,5 | 175 | 9    | 11   |                  |
| <b>LG10401H</b> | K3-700, -860       | K3-1000, -1200     | 280 | 73 | 334 | 280 | 380 | 175 | 232,5 | 120 | 11   | 13,5 |                  |

**LG10400V, LG10402V**

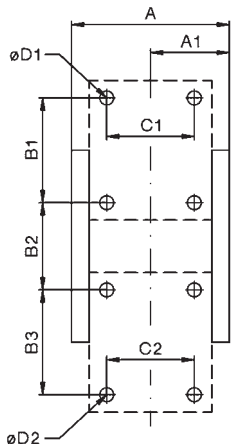

**LG10399V**

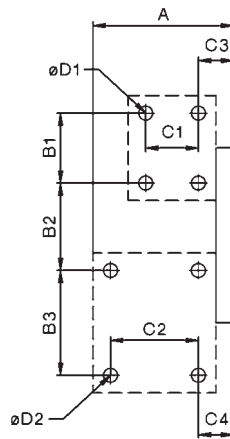

**LG10403V, LG10401V**

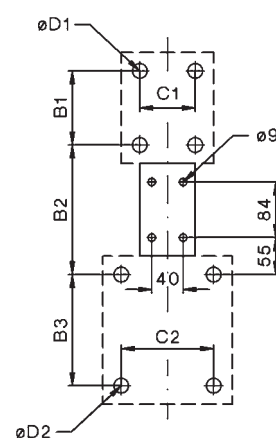

| Type            | Contactor 1     | Contactor 2     | A   | A1  | B1  | B2  | B3  | C1  | C2  | C3 | C4   | D1   | D2   |
|-----------------|-----------------|-----------------|-----|-----|-----|-----|-----|-----|-----|----|------|------|------|
| <b>LG10400V</b> | K3-315 - K3-550 | K3-315 - K3-550 | 250 | 134 | 220 | 94  | 220 | 110 | 110 | -  | -    | 9    | 9    |
| <b>LG10402V</b> | K3-700, -860    | K3-700, -860    | 302 | 162 | 280 | 200 | 280 | 175 | 175 | -  | -    | 11   | 11   |
| <b>LG10403V</b> | K3-1000, -1200  | K3-1000, -1200  | -   | -   | 380 | 280 | 380 | 120 | 120 | -  | -    | 13,5 | 13,5 |
| <b>LG10399V</b> | K3-450, -550    | K3-700, -860    | 302 | -   | 220 | 150 | 280 | 110 | 175 | 51 | 74,5 | 9    | 11   |
| <b>LG10401V</b> | K3-700, -860    | K3-1000, -1200  | -   | -   | 280 | 240 | 380 | 175 | 120 | -  | -    | 11   | 13,5 |

# Contactors

## Dimensions Accessories

### Latch

#### K2-L..

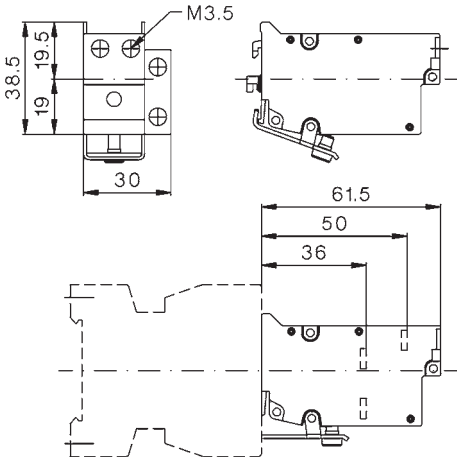

### Contactors with additional terminals

#### LG9339N (2 x 3 pieces) for K3-10N. to K3-22N.

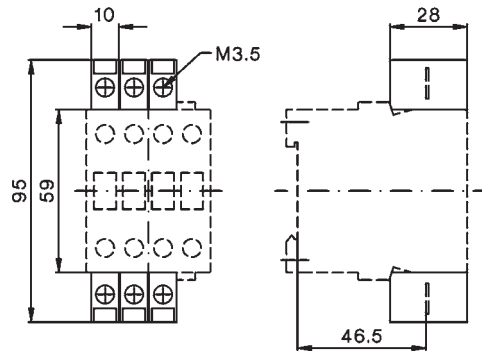

### Indicator units

#### K2-ING, K2-INR K2-UN, K2-UNR

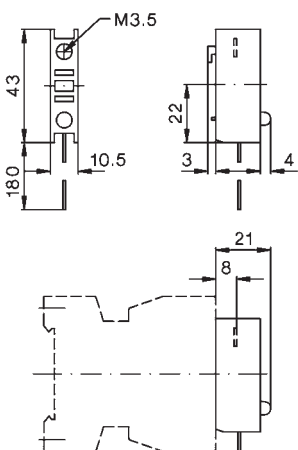

### Fuse holder

#### K2-RF

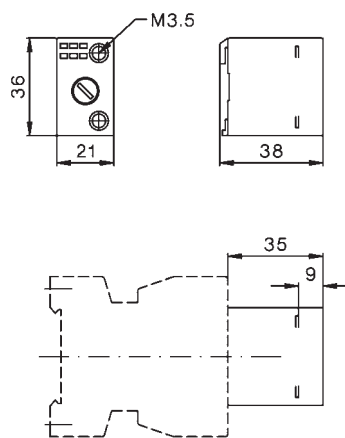

### Fuse holder with rectifier

#### K2-RF1 K2-RF3

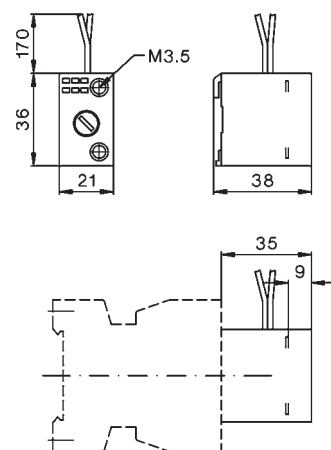

# Contactors

## Dimensions Accessories

### Interface

#### K2-IM

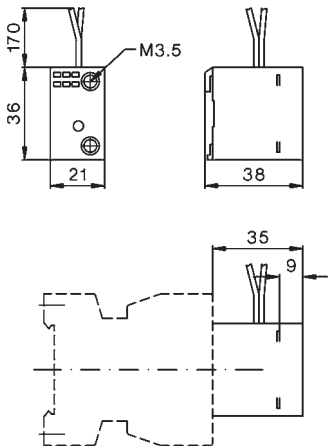

### Snap-on adapter

#### K2-SM

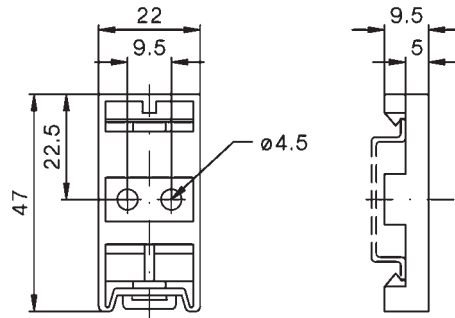

### Suppressor units

#### RC-K3N ..

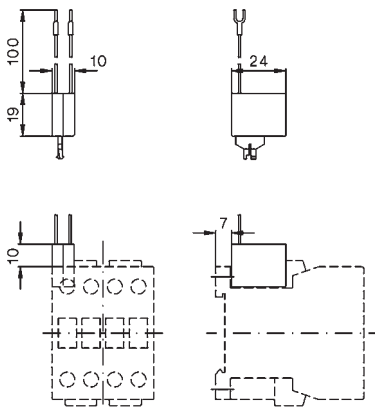

#### RC-K3NW ..

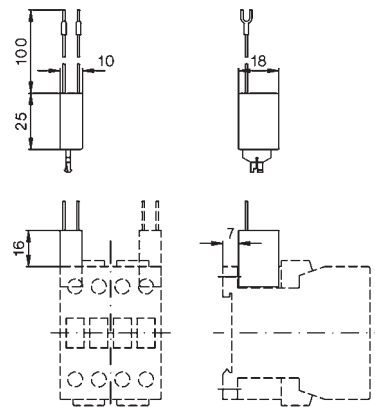

### Marking systems

marking label

**P487-1** or **P245-**

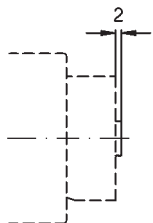



# Contactors

## Position of terminals

K3-10ND10  
K3-14ND10  
K3-18ND10  
K3-22ND10  
K3-18NK10

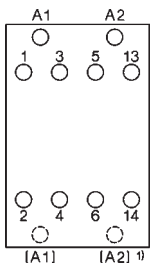

K3-10ND01  
K3-14ND01  
K3-18ND01  
K3-22ND01  
K3-18NK01

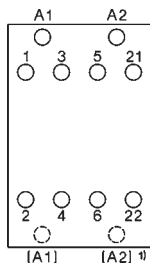

K3-24A00, K3-24K00  
K3-32A00, K3-32K00  
K3-40A00

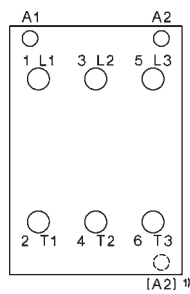

K3-50A00, K3-50K00  
K3-62A00, K3-62K00  
K3-74A00, K3-74K00

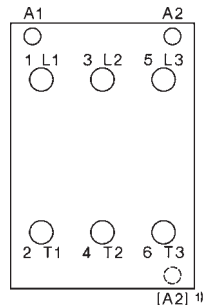

K3-10NA00-40  
K3-14NA00-40  
K3-18NA00-40  
K3-22NA00-40  
K2-23A00-40 to  
K2-60A00-40

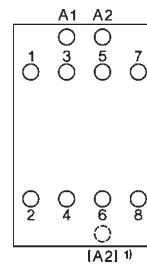

K85A22  
K110A22

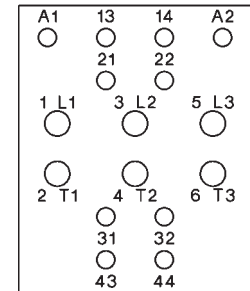

K3-90A00  
K3-115A00

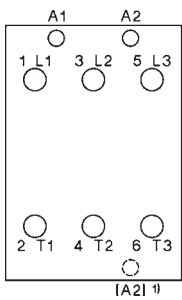

K3-151A00  
K3-176A00  
K3-210A00  
K3-260A00  
K3-316A00

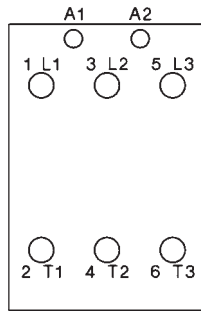

K3-116A00-40  
K3-151A00-40  
K3-176A00-40  
K3-210A00-40  
K3-260A00-40  
K3-316A00-40

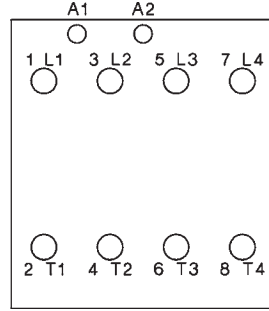

K3-450A22  
K3-550A22  
K3-700A22  
K3-860A22

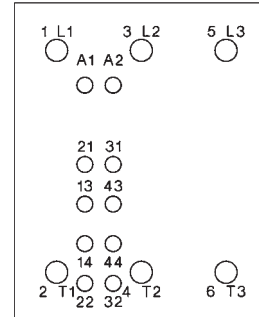

K3-1000A12  
K3-1200A12

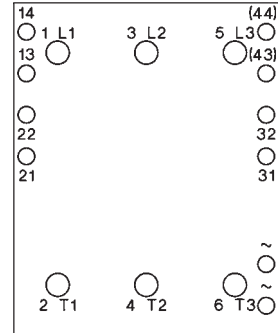

KG3-10A10  
KG3-14A10  
KG3-18A10  
KG3-22A10

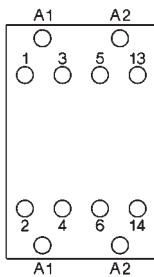

KG3-10A01  
KG3-14A01  
KG3-18A01  
KG3-22A01

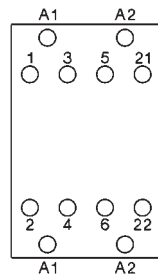

KG3-10A00-40  
KG3-14A00-40  
KG3-18A00-40  
KG3-22A00-40

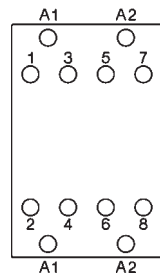

KG3-24A00  
KG3-32A00  
KG3-40A00

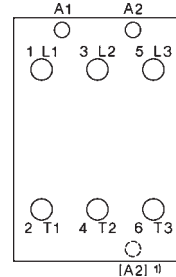

K3-10ND10=  
K3-14ND10=  
K3-18ND10=  
K3-22ND10=

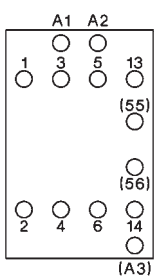

K3-10ND01=  
K3-14ND01=  
K3-18ND01=  
K3-22ND01=

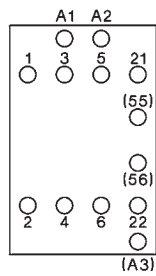

K3-24A00=  
K3-32A00=  
K3-40A00=

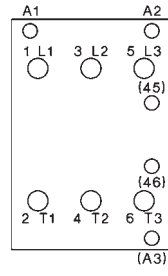

K3-50A00=  
K3-62A00=  
K3-74A00=

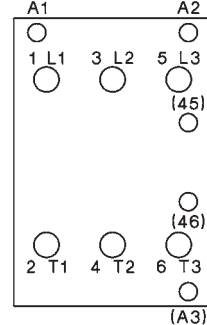

K85A21=  
K110A21=

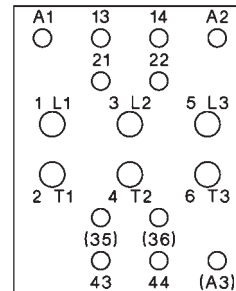

K3-1000A12=  
K3-1200A12=

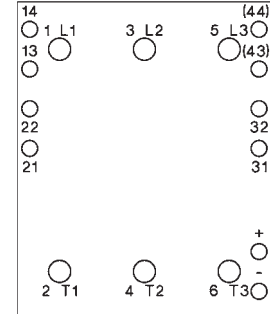

1) Type-suffix "EUR" with additional coil terminal  
Ordering example: K3-10ND10 EUR 230

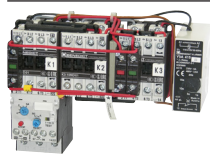

Star-Delta Starters Open Type 92



Star-Delta Starters Enclosed Enclosure for Star-Delta Starters 94

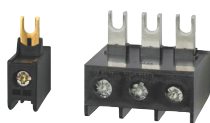

Accessories 95



Reversing Contactors 96



Pole Changing Starters 98



Technical Data 100

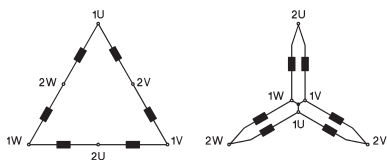

Wiring Diagrams 103

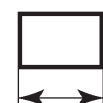

Dimensions 107

# Star-Delta Starters Open Type

AC Operated

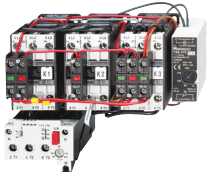

| Ratings |      | Rated Current |      | order separately    | Type              | Coil voltage <sup>1)</sup> | Pack pcs. | Weight kg/pc. |
|---------|------|---------------|------|---------------------|-------------------|----------------------------|-----------|---------------|
| AC3     |      |               |      |                     |                   | 220-240V 50Hz              |           |               |
| 380V    |      |               |      |                     |                   | 380-415V 50Hz              |           |               |
| 400V    | 660V | AC3           |      | Overload Relay      |                   |                            |           |               |
| 415V    | 500V | 690V          | 400V |                     |                   |                            |           |               |
| kW      | kW   | kW            | A    | Type                |                   |                            |           |               |
| 7,5     | 7,5  | 11            | 16   | U3/32<br>U12/16E K3 | <b>K3NY15 ...</b> |                            | 1         | 0,9           |
| 15      | 18,5 | 15            | 30   |                     | <b>K3NY26 ...</b> |                            | 1         | 0,9           |
| 22      | 30   | 22            | 45   | U3/42               | <b>K3Y40 ...</b>  |                            | 1         | 1,4           |
| 30      | 37   | 30            | 60   |                     | <b>K3Y52 ...</b>  |                            | 1         | 1,8           |
| 45      | 55   | 45            | 85   | U3/74               | <b>K3Y80 ...</b>  |                            | 1         | 3,5           |
| 55      | 75   | 55            | 109  |                     | <b>K3Y100 ...</b> |                            | 1         | 3,7           |
| 75      | 90   | 90            | 150  | U85                 | <b>K3Y140 ...</b> |                            | 1         | 6,6           |
| 110     | 132  | 110           | 205  |                     | <b>K3Y200 ...</b> |                            | 1         | 7             |
| 132     | 160  | 160           | 240  | U180                | <b>K3Y240 ...</b> |                            | 1         | 15            |
| 160     | 180  | 180           | 300  |                     | <b>K3Y300 ...</b> |                            | 1         | 15            |

Star-delta starters are wired to accept thermal overload relay. The thermal overload relay has to be ordered separately. For full load current setting use the YD-dial of thermal overload relay.

**Ordering Example:** Star-Delta Starter, open type, rated AC3 at 400V 205A rated control voltage 230V 50Hz - **Order Type: K3Y200 230 + U85 120**

## Thermal Overload Relays

| Rated Motor Current<br>A | Type | Pack pcs. | Weight kg/pc. | Wiring Diagram |
|--------------------------|------|-----------|---------------|----------------|
|--------------------------|------|-----------|---------------|----------------|

For Star-Delta Starters K3NY15.. to K3Y40..



|             |                      |   |      |
|-------------|----------------------|---|------|
| 7 - 10,5    | <b>U12/16E 6 K3</b>  | 1 | 0,10 |
| 10,5 - 15,5 | <b>U12/16E 9 K3</b>  | 1 | 0,10 |
| 14 - 19     | <b>U12/16E 11 K3</b> | 1 | 0,10 |
| 18 - 24     | <b>U12/16E 14 K3</b> | 1 | 0,10 |
| 23 - 31     | <b>U12/16E 18 K3</b> | 1 | 0,10 |

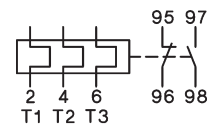

manual reset

For Star-Delta Starters K3NY15.. to K3Y52..



|             |                 |   |      |
|-------------|-----------------|---|------|
| 7 - 10,5    | <b>U3/32 6</b>  | 1 | 0,14 |
| 10,5 - 15,5 | <b>U3/32 9</b>  | 1 | 0,14 |
| 14 - 19     | <b>U3/32 11</b> | 1 | 0,14 |
| 18 - 24     | <b>U3/32 14</b> | 1 | 0,14 |
| 23 - 31     | <b>U3/32 18</b> | 1 | 0,14 |
| 30 - 41     | <b>U3/32 24</b> | 1 | 0,14 |
| 40 - 55     | <b>U3/32 32</b> | 1 | 0,14 |

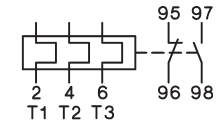

manual and auto reset

For Star-Delta Starters K3Y40.., K3Y52..



|         |                 |   |      |
|---------|-----------------|---|------|
| 24 - 35 | <b>U3/42 20</b> | 1 | 0,30 |
| 35 - 48 | <b>U3/42 28</b> | 1 | 0,30 |
| 48 - 73 | <b>U3/42 42</b> | 1 | 0,30 |

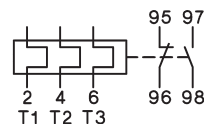

manual and auto reset

1) Coil voltage range and other coil voltages see page 100

| Components for Combinations |                   |                         | Electronic Timer | Mechanical Interlock between K2 and K3 | Star-Delta Starter Connector Type | Auxiliary Contacts Built-in for use on Contactor |          |         | Free Space for Aux. Contact Blocks on Contactor |          |         |
|-----------------------------|-------------------|-------------------------|------------------|--|-----------------------------------|--|----------|---------|---|----------|---------|
| Line Contactor              | Delta Contactor   | Star Contactor          |                  |  |                                   | Line K1  | Delta K2 | Star K3 | Line K1   | Delta K2 | Star K3 |
| K1 Type                     | K2 Type           | K3 Type                 | K4 Type          | K2 and K3 Type                         |                                   |  |          |         |   |          |         |
| K3-10ND01 + HN10            | K3-10ND01         | K3-10ND10 + HN10 + HN01 | Y9A              | LG10889                                | K3NY-VB10                         | -  | -        | -       | 3   | 4        | 2       |
| K3-18ND01 + HN10            | K3-18ND01         | K3-14ND10 + HN10 + HN01 | Y9A              | LG10889                                | K3NY-VB10                         | -  | -        | -       | 3   | 4        | 2       |
| K3-24A00 + HN10 + HN01      | K3-24A00 + HN01   | K3-24A00 + 2HN10 + HN01 | Y9A              | LG10889                                | K3Y-VB24                          | -  | -        | -       | 2   | 3        | 1       |
| K3-32A00 + HN10 + HN01      | K3-32A00 + HN01   | K3-24A00 + 2HN10 + HN01 | Y9A              | LG10889                                | K3Y-VB24                          | -  | -        | -       | 2   | 3        | 1       |
| K3-50A00 + HN01 + HN10      | K3-50A00 + HN01   | K3-32A00 + 2HN10 + HN01 | Y9A              | LG10890                                | -                                 | -  | -        | -       | 2   | 3        | 1       |
| K3-62A00 + HN01 + HN10      | K3-62A00 + HN01   | K3-50A00 + 2HN10 + HN01 | Y9A              | LG10890                                | -                                 | -  | -        | -       | 2   | 3        | 1       |
| K3-90A00 + HN01 + HN10      | K3-90A00 + HN01   | K3-90A00 + 2HN10 + HN01 | Y9AL             | LG11478                                | -                                 | -  | -        | -       | 5   | 6        | 4       |
| K3-115A00 + HN01 + HN10     | K3-115A00 + HN01  | K3-90A00 + 2HN10 + HN01 | Y9AL             | LG11478                                | -                                 | -  | -        | -       | 5   | 6        | 4       |
| K3-151A00 + HKT11           | K3-151A00 + HKT11 | K3-151A00 + HKT22       | Y9AL             | LG11223H                               | -                                 | -  | 1/-      | -/1     | 2   | 1        | 1       |
| K3-176A00 + HKT11           | K3-176A00 + HKT11 | K3-151A00 + HKT22       | Y9AL             | LG11223H                               | -                                 | -  | 1/-      | -/1     | 2   | 1        | 1       |

**Applications**

The star-delta starting method is only practicable in such cases where the motor windings are connected in delta configuration for normal operation and the torque which is needed during the starting period is not higher than approx. 30% of the rated torque. The starting current drawn from the line will be approx. 2 to 2,7 times the rated motor current.

**Time setting**

The transition from start (star configuration) to normal operation (delta configuration) should be after the motor achieves practically full rotational speed. The use of star-delta timer Y9A with a dwell period of approx. 25ms provides a careful operation of motor and drive equipment.

**Thermal Overload Relays**



**Rated Motor Current**  
A

**Type**

Pack pcs. Weight kg/pc.

Wiring Diagram

For Star-Delta Starters K3Y80.., K3Y100..

|          |                 |   |      |
|----------|-----------------|---|------|
| 35 - 48  | <b>U3/74 28</b> | 1 | 0,40 |
| 48 - 73  | <b>U3/74 42</b> | 1 | 0,40 |
| 70 - 90  | <b>U3/74 52</b> | 1 | 0,40 |
| 90 - 112 | <b>U3/74 65</b> | 1 | 0,40 |

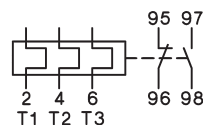

manual and auto reset

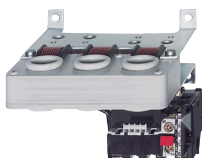

For Star-Delta Starters K3Y140.., K3Y200..

|           |                |   |      |
|-----------|----------------|---|------|
| 104 - 156 | <b>U85 90</b>  | 1 | 0,90 |
| 140 - 207 | <b>U85 120</b> | 1 | 0,90 |

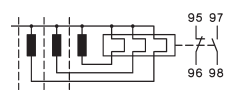

manual reset

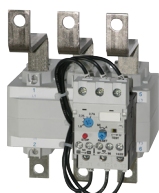

For Star-Delta Starters K3Y240.., K3Y300..

|           |                 |   |     |
|-----------|-----------------|---|-----|
| 208 - 312 | <b>U180 180</b> | 1 | 1,5 |
|-----------|-----------------|---|-----|

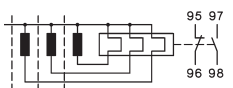

manual and auto reset

# Star-Delta Starters Enclosed Type

AC Operated

| Ratings     |      | Rated Current | Optional Extras | Wired to accept Overload Relay | Type       | Coil voltage <sup>1)</sup> | Pack pcs. | Weight kg/pc. |
|-------------|------|---------------|-----------------|--------------------------------|------------|----------------------------|-----------|---------------|
| AC3         |      |               |                 |                                |            | 220-240V 50Hz              |           |               |
| <b>380V</b> |      |               |                 |                                | <b>230</b> | 380-415V 50Hz              |           |               |
| <b>400V</b> | 660V | AC3           |                 |                                | <b>400</b> |                            |           |               |
| <b>415V</b> | 500V | 690V          | 400V            |                                | ↓          |                            |           |               |
| <b>kW</b>   | kW   | kW            | A               | Type                           |            |                            |           |               |



## Plastic Enclosed, protected to IP65

| Rated Current | Rated Power (kW) | Rated Voltage (V) | Rated Current (A) | Optional Extras | Wiring | Type               | Pack pcs. | Weight kg/pc. |
|---------------|------------------|-------------------|-------------------|-----------------|--------|--------------------|-----------|---------------|
| 7,5           | 7,5              | 11                | 16                | ST              | U3/32  | <b>K3NY15P ...</b> | 1         | 1,8           |
| 15            | 18,5             | 15                | 30                | ST              |        | <b>K3NY26P ...</b> | 1         | 1,8           |
| 22            | 30               | 22                | 45                | ST, H           | U3/42  | <b>K3Y40P ...</b>  | 1         | 3,8           |
| 30            | 37               | 30                | 60                | ST, H           |        | <b>K3Y52P ...</b>  | 1         | 4,2           |
| 45            | 55               | 45                | 85                | ST, H           | U3/74  | <b>K3Y80P ...</b>  | 1         | 5,9           |
| 55            | 75               | 55                | 109               | ST, H           |        | <b>K3Y100P ...</b> | 1         | 8,7           |



## Sheet Steel Enclosed, protected to IP54

| Rated Current | Rated Power (kW) | Rated Voltage (V) | Rated Current (A) | Optional Extras | Wiring | Type               | Pack pcs. | Weight kg/pc. |
|---------------|------------------|-------------------|-------------------|-----------------|--------|--------------------|-----------|---------------|
| 7,5           | 7,5              | 11                | 16                | ST,H            | U3/32  | <b>K3NY15B ...</b> | 1         | 2,8           |
| 15            | 18,5             | 15                | 30                | ST, H           |        | <b>K3NY26B ...</b> | 1         | 2,8           |
| 22            | 30               | 22                | 45                | ST, H           | U3/42  | <b>K3Y40B ...</b>  | 1         | 4,8           |
| 30            | 37               | 30                | 60                | ST, H           |        | <b>K3Y52B ...</b>  | 1         | 5,2           |
| 45            | 55               | 45                | 85                | ST, H           | U3/74  | <b>K3Y80B ...</b>  | 1         | 15            |
| 55            | 75               | 55                | 109               | ST, H           |        | <b>K3Y100B ...</b> | 1         | 15            |
| 75            | 90               | 90                | 150               | ST, H           | U85    | <b>K3Y140B ...</b> | 1         | 22            |
| 110           | 132              | 110               | 205               | ST, H           |        | <b>K3Y200B ...</b> | 1         | 22            |

1) Coil voltage range and other coil voltages see page 100

### Type-suffix for optional extras

|                                      |             |
|--------------------------------------|-------------|
| Start-Stop Push Buttons              | .....T ...  |
| Selector Switch                      | .....W ...  |
| Control Circuit Fuse <250V (1 piece) | .....ST ... |
| >250V (2 pieces)                     | .....ST ... |
| Run Hour Meter                       | .....H ...  |

**Ordering Example:** Star-Delta Starter, steel sheet enclosed, with selector switch and run hour meter rated AC3 at 400V 82A, rated control voltage 230V 50Hz - **Order Type: K3Y80BWH 230 + U3/74 52**

## Enclosures for Star Delta Starter



| for Starter             | accept Overload Relay | Type                | Pack pcs. | Weight kg/pc. |
|-------------------------|-----------------------|---------------------|-----------|---------------|
| <b>Plastic IP65</b>     |                       |                     |           |               |
| <b>K3NY15, K3NY26</b>   | U3/32                 | <b>K3Y26P-G3</b>    | 1         | 1,0           |
| <b>K3Y40, K3Y52</b>     | U3/42, U3/32          | <b>K3Y40/52P-G3</b> | 1         | 2,4           |
| <b>Sheet Steel IP54</b> |                       |                     |           |               |
| <b>K3NY15, K3NY26</b>   | U3/32                 | <b>K3Y26B-G3</b>    | 1         | 3,4           |
| <b>K3Y40, K3Y52</b>     | U3/42, U3/32          | <b>K3Y40/52B-G3</b> | 1         | 3,4           |

## Star-Delta Starter Connector



For Star-Delta Starter Types

|                | Type             | Pack pcs. | Weight kg/pc. |
|----------------|------------------|-----------|---------------|
| K3NY15, K3NY26 | <b>K3NY-VB10</b> | 1         | 0,02          |
| K3Y40, K3Y52   | <b>K3Y-VB24</b>  | 1         | 0,03          |

## Additional Terminals



For Star-Delta Starter Types  
Line Conn. Motor Conn.  
Line Contactor Overload Relay

Cable cross-section mm<sup>2</sup>

Type

Pack pcs. Weight kg/pc.

### Single pole with Fingertouch Protection

|                |        |                                   |               |   |       |
|----------------|--------|-----------------------------------|---------------|---|-------|
| K3NY15, K3NY26 | U12/16 | 0,75 - 10 solid<br>0,75 - 6 flex. | <b>LG9339</b> | 6 | 0,009 |
|----------------|--------|-----------------------------------|---------------|---|-------|

### Three-pole with Fingertouch Protection

|  |       |                                |               |   |       |
|--|-------|--------------------------------|---------------|---|-------|
|  | U3/42 | 4 - 35 strand.<br>4 - 25 flex. | <b>LG7559</b> | 1 | 0,052 |
|--|-------|--------------------------------|---------------|---|-------|

## Electronic Timers for Star-Delta Starters<sup>1)</sup>



| Rated Control Voltage V | Time Range s | Delay Time ms | Rated Current AC15 |        | Type            | Pack pcs. | Weight kg/pc. |
|-------------------------|--------------|---------------|--------------------|--------|-----------------|-----------|---------------|
|                         |              |               | 230V A             | 400V A |                 |           |               |
| 24 - 60V AC             | 1 - 20       | 20 - 25       | 6                  | 4      | <b>Y9A 60</b>   | 1         | 0,075         |
| 110 - 415V AC           | 1 - 20       | 20 - 25       | 6                  | 4      | <b>Y9A 415</b>  | 1         | 0,075         |
| 24 - 60V~               | 1 - 20       | 40 - 80       | 6                  | 4      | <b>Y9AL 60</b>  | 1         | 0,075         |
| 110 - 415V~             | 1 - 20       | 40 - 80       | 6                  | 4      | <b>Y9AL 415</b> | 1         | 0,075         |

|                                     |            |                      |          |       |
|-------------------------------------|------------|----------------------|----------|-------|
| Time repeat accuracy                | ± 1%       | Power consumption at | 24V      | 0,2VA |
| Minimum interval between operations | 2s         |                      | 60V      | 5VA   |
| Short circuit protection            | 4A gl (gG) |                      | 220-240V | 2VA   |
|                                     |            |                      | 380-415V | 7VA   |

1) not suitable for contactors K3-450 - K3-1200

## Mounting Bar

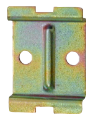

| Specification                               | Type          | Pack pcs. | Weight kg/pc. |
|---|---------------|-----------|---------------|
| For screw mounting of electronic timer Y9.. | <b>LG7735</b> | 10        | 0,09          |

## Star-Delta Starters in Special Versions

### Starters for Longer Starting Time

For longer starting times the thermal overload relay is mounted on delta-contactor. The motor is not protected in Y-connection. The timer used for this starter-type is the type Y91A, time range is 10 to 60s. Principal wiring diagram see page 104.

**Ordering Example:** K3YL52 230

### Starters with two Thermal Overload Relays on request

Basic circuit diagram see page 104

## Reversing Contactors with Mechanical Interlock

AC Operated

| Ratings     |      | Rated Current | Vorbereitet für Einbau | Wired to accept Overload Relay page 120 Type | Type | Coil voltage <sup>1)</sup> | Pack pcs. | Weight kg/pc. |
|-------------|------|---------------|------------------------|--|------|----------------------------|-----------|---------------|
| AC3         |      |               |                        |  |      | 110V 50Hz                  |           |               |
| <b>380V</b> |      |               |                        |  |      | 220-240V 50Hz              |           |               |
| <b>400V</b> |      | 660V          | AC3                    |  |      | 380-415 50Hz               |           |               |
| <b>415V</b> | 500V | 690V          | 400V                   |  |      |                            |           |               |
| <b>kW</b>   | kW   | kW            | A                      |  |      |                            |           |               |

### Open Type

|             |      |      |    |                     |                    |   |     |
|-------------|------|------|----|---------------------|--------------------|---|-----|
| <b>4</b>    | 5,5  | 5,5  | 10 | U3/32<br>U12/16E K3 | <b>K3NWU10 ...</b> | 1 | 0,6 |
| <b>7,5</b>  | 10   | 7,5  | 18 |                     | <b>K3NWU18 ...</b> | 1 | 0,6 |
| <b>11</b>   | 15   | 15   | 24 | U3/42               | <b>K3WU24 ...</b>  | 1 | 1,2 |
| <b>15</b>   | 18,5 | 18,5 | 32 |                     | <b>K3WU32 ...</b>  | 1 | 1,4 |
| <b>18,5</b> | 18,5 | 18,5 | 40 |                     | <b>K3WU40</b>      | 1 | 1,4 |
| <b>22</b>   | 30   | 30   | 50 | U3/74               | <b>K3WU50 ...</b>  | 1 | 2,5 |
| <b>30</b>   | 37   | 37   | 62 |                     | <b>K3WU62 ...</b>  | 1 | 2,5 |
| <b>37</b>   | 45   | 45   | 74 |                     | <b>K3WU74 ...</b>  | 1 | 2,5 |



### Sheet Steel Enclosed, protected to IP54

|            |      |      |    |       |                     |   |     |
|------------|------|------|----|-------|---------------------|---|-----|
| <b>4</b>   | 5,5  | 5,5  | 10 | U3/32 | <b>K3NWU10B ...</b> | 1 | 3,9 |
| <b>7,5</b> | 10   | 7,5  | 18 |       | <b>K3NWU18B ...</b> | 1 | 4,1 |
| <b>11</b>  | 15   | 15   | 24 | U3/42 | <b>K3WU24B ...</b>  | 1 | 4,5 |
| <b>15</b>  | 18,5 | 18,5 | 32 |       | <b>K3WU32B ...</b>  | 1 | 4,7 |
| <b>22</b>  | 30   | 30   | 50 | U3/74 | <b>K3WU50B ...</b>  | 1 | 7,1 |
| <b>30</b>  | 37   | 37   | 62 |       | <b>K3WU62B ...</b>  | 1 | 7,1 |



## Reversing Starter Connector



For Reversing Starter Types

|                  | Type             | Pack pcs. | Weight kg/pc. |
|------------------|------------------|-----------|---------------|
| K3NWU10, K3NWU18 | <b>K3NW-VB10</b> | 1         | 0,02          |
| K3WU24, K3WU32   | <b>K3W-VB24</b>  | 1         | 0,025         |

1) Other coil voltages see page 57

| Components for Combinations |                           | Mechanical Interlock | Reversing Starter Connector | Auxiliary Contacts Built-in for use on Contactor |          | Free Space for Aux. Contact Blocks on Contactor |    |
|-----------------------------|---------------------------|----------------------|-----------------------------|--|----------|---|----|
| Left Hand Side Contactor    | Right Hand Side Contactor |                      |                             | K1 NO/NC   | K2 NO/NC | K1 HN.. or HA..                                 | K2 |
| K1 Type                     | K2 Type                   | Type                 | Type                        |  |          |   |    |
| K3-10ND10 + HN01            | K3-10ND10 + HN01          | LG10889              | K3NW-VB10                   | -  | -        | 3   | 3  |
| K3-18ND10 + HN01            | K3-18ND10 + HN01          | LG10889              | K3NW-VB10                   | -  | -        | 3   | 3  |
| K3-24A00 + HN10 + HN01      | K3-24A00 + HN10 + HN01    | LG10889              | K3W-VB24                    | -  | -        | 2   | 2  |
| K3-32A00 + HN10 + HN01      | K3-32A00 + HN10 + HN01    | LG10889              | K3W-VB24                    | -  | -        | 2   | 2  |
| K3-40A00 + HN10 + HN01      | K3-40A00 + HN10 + HN01    | LG10889              | K3W-VB24                    | -  | -        | 2   | 2  |
| K3-50A00 + HN10 + HN01      | K3-50A00 + HN10 + HN01    | LG10890              | -                           | -  | -        | 2   | 2  |
| K3-62A00 + HN10 + HN01      | K3-62A00 + HN10 + HN01    | LG10890              | -                           | -  | -        | 2   | 2  |
| K3-74A00 + HN10 + HN01      | K3-74A00 + HN10 + HN01    | LG10890              | -                           | -  | -        | 2   | 2  |
| K3-10ND10 + HN01            | K3-10ND10 + HN01          | LG10889              | K3NW-VB10                   | -  | -        | 3   | 3  |
| K3-18ND10 + HN01            | K3-18ND10 + HN01          | LG10889              | K3NW-VB10                   | -  | -        | 3   | 3  |
| K3-24A00 + HN10 + HN01      | K3-24A00 + HN10 + HN01    | LG10889              | K3W-VB24                    | -  | -        | 2   | 2  |
| K3-32A00 + HN10 + HN01      | K3-32A00 + HN10 + HN01    | LG10889              | K3W-VB24                    | -  | -        | 2   | 2  |
| K3-50A00 + HN10 + HN01      | K3-50A00 + HN10 + HN01    | LG10890              | -                           | -  | -        | 2   | 2  |
| K3-62A00 + HN10 + HN01      | K3-62A00 + HN10 + HN01    | LG10890              | -                           | -  | -        | 2   | 2  |

Contactor, Motor-Starter

Circuit Breakers

Manual Motor-Starters

Switches

AC-Main Switches

DC-Switch Disconnect

Push Buttons

Representatives, Suppliers



## Pole Changing Starters

AC Operated

| Ratings |      | Rated Current |      | Wired to accept Overload Relay page 120 Type | Type            | Coil voltage <sup>1)</sup><br>220-240V 50Hz<br>380-415 50Hz | Pack pcs. | Weight kg/pc. |
|---------|------|---------------|------|--|-----------------|---|-----------|---------------|
| AC3     | 380V | 660V          | AC3  |  |                 |   |           |               |
| 400V    |      |               | 400V |  | 230<br>400<br>↓ |   |           |               |
| 415V    | 500V | 690V          | 400V |  |                 |   |           |               |
| kW      | kW   | kW            | A    |  |                 |   |           |               |

### Open Type



|     |      |      |    |                             |             |   |     |
|-----|------|------|----|-----------------------------|-------------|---|-----|
| 7,5 | 10   | 10   | 18 | 2 x U3/32<br>2 x U12/16E K3 | K3NPU18 ... | 1 | 1,0 |
| 11  | 15   | 15   | 24 |                             | K3NPU24 ... | 1 | 1,5 |
| 15  | 18,5 | 18,5 | 32 | 2 x U3/32                   | K3PU32 ...  | 1 | 1,9 |
| 22  | 30   | 30   | 50 | 2 x U3/74                   | K3PU50 ...  | 1 | 3,9 |
| 30  | 37   | 37   | 62 |                             | K3PU62 ...  | 1 | 3,9 |

### Sheet Steel Enclosed, protected to IP54



|     |      |      |    |          |              |   |     |
|-----|------|------|----|----------|--------------|---|-----|
| 7,5 | 10   | 7,5  | 18 | 2x U3/32 | K3NPU18B ... | 1 | 1,0 |
| 11  | 15   | 15   | 24 |          | K3NPU24B ... | 1 | 1,5 |
| 15  | 18,5 | 18,5 | 32 |          | K3PU32B ...  | 1 | 1,9 |

**Ordering Example:** Pole Changing Starter, open version, rated AC3 at 400V 28A and 15A, control voltage 230V 50Hz  
**Order Type:** K3PU32 230 + U3/32 32 + U3/32 18

Pole Changing Starters for Star-Delta Operation on request

1) Other coil voltages see page 57

| Components for Combinations   |                           |                    | Free Space for                                    |              |         |
|-------------------------------|---------------------------|--------------------|---|--------------|---------|
| High Speed                    | Low Speed                 | Star Contactor     | Aux. Contact Blocks on High Speed K1 HN.. or HA.. | Low Speed K2 | Star K3 |
| K1 Type                       | K2 Type                   | K3 Type            |   |              |         |
| K3-18ND01<br>+ 2 x HN10       | K3-18ND01<br>+ HN10       | K3-14ND10          | 2   | 3            | 4       |
| K3-24A00<br>+ HN01 + 2 x HN10 | K3-24A00<br>+ HN01 + HN10 | K3-18ND10          | 1   | 2            | 4       |
| K3-32A00<br>+ HN01 + 2 x HN10 | K3-32A00<br>+ HN01 + HN10 | K3-24A00<br>+ HN10 | 1   | 2            | 3       |
| K3-50A00<br>+ HN01 + 2 x HN10 | K3-50A00<br>+ HN01 + HN10 | K3-32A00<br>+ HN10 | 1   | 2            | 3       |
| K3-62A00<br>+ HN01 + 2 x HN10 | K3-62A00<br>+ HN01 + HN10 | K3-50A00<br>+ HN10 | 1   | 2            | 3       |
| K3-18ND01<br>+ 2 x HN10       | K3-18ND01<br>+ HN10       | K3-14ND10          | 2   | 3            | 4       |
| K3-24A00<br>+ HN01 + 2 x HN10 | K3-24A00<br>+ HN01 + HN10 | K3-18ND10          | 1   | 2            | 4       |
| K3-32A00<br>+ HN01 + 2 x HN10 | K3-32A00<br>+ HN01 + HN10 | K3-24A00<br>+ HN10 | 1   | 2            | 3       |

# Star-Delta Starters

## Data according to IEC 947-4-1, VDE 0660, EN 60947-4-1

| Type  |                                   | K3NY15                | K3NY26                | K3Y40     | K3Y52     | K3Y80     | K3Y100                | K3Y140     | K3Y200     | K3Y240     | K3Y300     |            |
|---|-----------------------------------|-----------------------|-----------------------|-----------|-----------|-----------|-----------------------|------------|------------|------------|------------|------------|
| <b>Main Contacts</b>                                  |                                   |                       |                       |           |           |           |                       |            |            |            |            |            |
| Rated insulation voltage $U_i^{(1)}$                  | V AC                              | 690                   | 690                   | 690       | 690       | 690       | 690                   | 690        | 690        | 690        | 690        |            |
| Frequency of operations $z_{AC3, I_e}$                | 1/h                               | 15                    |                       |           |           |           |                       |            |            |            |            |            |
| Change-over time max. (Y-step)                        | s                                 | 20 (Type K3YL ... 60) |                       |           |           |           |                       |            |            |            |            |            |
| <b>Utilization category AC3</b>                       |                                   |                       |                       |           |           |           |                       |            |            |            |            |            |
| <b>Switching of three-phase motors</b>                |                                   |                       |                       |           |           |           |                       |            |            |            |            |            |
| Rated operational current $I_e$                       | 220-230V                          | A                     | 16                    | 30        | 45        | 60        | 85                    | 109        | 150        | 205        | 240        | 300        |
|   | 240V                              | A                     | 16                    | 30        | 45        | 60        | 85                    | 109        | 150        | 205        | 240        | 300        |
|   | <b>380-400V</b>                   | <b>A</b>              | <b>16</b>             | <b>30</b> | <b>45</b> | <b>60</b> | <b>85</b>             | <b>109</b> | <b>150</b> | <b>205</b> | 240        | 300        |
| Rated operational power of three-phase motors 50-60Hz | 415-440V                          | A                     | 15                    | 30        | 45        | 60        | 85                    | 109        | 150        | 205        | 240        | 300        |
|   | 500V                              | A                     | 15                    | 30        | 45        | 60        | 85                    | 95         | 150        | 205        | 190        | 240        |
|   | 660-690V                          | A                     | 13                    | 17        | 30        | 36        | 57                    | 72         | 103        | 118        | 147        | 180        |
|   |                                   |                       |                       |           |           |           |                       |            |            |            |            |            |
| Rated operational power of three-phase motors 50-60Hz | 220-230V                          | kW                    | 4                     | 7,5       | 11        | 15        | 22                    | 30         | 45         | 55         | 75         | 90         |
|   | 240V                              | kW                    | 5,5                   | 11        | 15        | 18,5      | 22                    | 30         | 45         | 55         | 75         | 90         |
|   | <b>380-400V</b>                   | <b>kW</b>             | <b>7,5</b>            | <b>15</b> | <b>22</b> | <b>30</b> | <b>45</b>             | <b>55</b>  | <b>75</b>  | <b>110</b> | <b>132</b> | <b>160</b> |
|   |                                   |                       |                       |           |           |           |                       |            |            |            |            |            |
| Rated operational power of three-phase motors 50-60Hz | 415-440V                          | kW                    | 7,5                   | 15        | 22        | 30        | 45                    | 55         | 75         | 110        | 140        | 170        |
|   | 500V                              | kW                    | 7,5                   | 18,5      | 30        | 37        | 55                    | 75         | 90         | 132        | 132        | 180        |
|   | 660-690V                          | kW                    | 11                    | 15        | 22        | 30        | 45                    | 55         | 90         | 110        | 132        | 180        |
|   |                                   |                       |                       |           |           |           |                       |            |            |            |            |            |
| <b>Cable cross-sections</b>                           |                                   |                       |                       |           |           |           |                       |            |            |            |            |            |
| Line  | solid or stranded                 | mm <sup>2</sup>       | 1,5 - 6 <sup>2)</sup> |           | 1,5 - 16  |           | 10 - 70 <sup>3)</sup> |            | 10 - 120   |            | busbar     |            |
|   | flexible                          | mm <sup>2</sup>       | 1,5 - 4 <sup>2)</sup> |           | 1,5 - 16  |           | 16 - 50 <sup>3)</sup> |            | 10 - 95    |            | 18x5       |            |
|   | flexible with multicore cable end | mm <sup>2</sup>       | 1,5 - 4 <sup>2)</sup> |           | 1,5 - 16  |           | 10 - 35               |            | 10 - 95    |            | M8         |            |
| Motor   | solid or stranded                 | mm <sup>2</sup>       | 1,5 - 6               |           | 1,5 - 16  |           | 4 - 35 <sup>3)</sup>  |            | 10 - 120   |            | busbar     |            |
|   | flexible                          | mm <sup>2</sup>       | 1,5 - 4               |           | 1,5 - 16  |           | 6 - 25 <sup>3)</sup>  |            | 10 - 95    |            | 18x5       |            |
|   | flexible with multicore cable end | mm <sup>2</sup>       | 1,5 - 4               |           | 1,5 - 16  |           | 4 - 25                |            | 10 - 95    |            | M8         |            |
| <b>Power consumption of the combination</b>           |                                   |                       |                       |           |           |           |                       |            |            |            |            |            |
| inrush and change-over                                | VA                                |                       | 55                    |           | 130       |           | 183                   |            | 560        |            | 700        |            |
|   | sealed VA                         |                       | 20                    |           | 26        |           | 36                    |            | 10         |            | 10         |            |
|   | W                                 |                       | 6                     |           | 8         |           | 14                    |            | 10         |            | 10         |            |

## Coil Voltage Ranges and Non Standard Voltages for Star-Delta Starters

### K3NY15.. to K3Y100..

| Suffix to Star-Delta Starter type<br>e.g. K3Y80 <b>400</b> | Rated Control Voltage $U_s$<br>range for 50Hz |            | range for 60Hz |            |
|--|---|------------|----------------|------------|
|  | min. V  | max. V     | min. V         | max. V     |
| 24   | 24  | 24         | 24             | 27         |
| 42   | 42  | 47         | 47             | 52         |
| 110  | 100   | 110        | 110            | 122        |
| 180  | 180   | 210        | 200            | 240        |
| <b>230</b>   | <b>220</b>                                    | <b>240</b> | <b>230</b>     | <b>264</b> |
| <b>400</b>   | <b>380</b>                                    | <b>415</b> | <b>400</b>     | <b>415</b> |

### K3Y140, to K3Y300..

| Suffix to Star-Delta Starter type<br>e.g. K3Y300 <b>230</b> | Rated Control Voltage $U_s$<br>range for 50Hz |            | range for 60Hz |            | for DC<br>V |
|---|---|------------|----------------|------------|-------------|
|   | min. V  | max. V     | min. V         | max. V     |             |
| 24  | 24  | 24         | 24             | 24         | 24          |
| 48  | 48  | 48         | 48             | 48         | 48          |
| 110   | 110   | 120        | 110            | 120        | 110         |
| <b>230</b>  | <b>220</b>                                    | <b>240</b> | <b>220</b>     | <b>240</b> | <b>220</b>  |
| <b>400</b>  | <b>380</b>                                    | <b>415</b> | <b>380</b>     | <b>415</b> | -           |

### Standard voltages in bold type letters

1) Suitable for: earthed-neutral systems, overvoltage category I to IV, pollution degree 3 (standard-industry):  $U_{imp} = 8kV$ .  
Data for other conditions on request.

2) Additional terminals see page 95

3) Maximum cable cross-section with prepared conductor

# Reversing Starters

Data according to IEC 947-4-1, VDE 0660, EN 60947-4-1

| Type  |                                   | K3NWU10         | K3NWU18    | K3WU24    | K3WU32    | K3WU50    | K3WU62    | K3WU74    |
|---|-----------------------------------|-----------------|------------|-----------|-----------|-----------|-----------|-----------|
| <b>Main Contacts</b>                                  |                                   |                 |            |           |           |           |           |           |
| Rated insulation voltage $U_i^{(1)}$                  | V AC                              | 690             | 690        | 690       | 690       | 690       | 690       | 690       |
| <b>Utilization category AC3</b>                       |                                   |                 |            |           |           |           |           |           |
| <b>Switching of three-phase motors</b>                |                                   |                 |            |           |           |           |           |           |
| Rated operational current $I_e$                       | 220V A                            | 12              | 18         | 23        | 30        | 45        | 63        |           |
|   | 230V A                            | 11,5            | 18         | 24        | 32        | 50        | 62        | 74        |
|   | 240V A                            | 11              | 18         | 24        | 32        | 50        | 62        | 74        |
|   | <b>380-400V A</b>                 | <b>10</b>       | <b>18</b>  | <b>24</b> | <b>32</b> | <b>50</b> | <b>62</b> | <b>74</b> |
|   | 415-440V A                        | 9               | 18         | 23        | 30        | 50        | 62        | 74        |
|   | 500V A                            | 9               | 16         | 23        | 30        | 45        | 60        | 74        |
|   | 660-690V A                        | 6,5             | 8,5        | 17        | 20        | 31        | 40        | 40        |
| Rated operational power of three-phase motors 50-60Hz | 220-230V kW                       | 3               | 5          | 6         | 8,5       | 12,5      | 18,5      |           |
|   | 240V kW                           | 3               | 5          | 7         | 9         | 13,5      | 19        | 23        |
|   | <b>380-400V kW</b>                | <b>4</b>        | <b>7,5</b> | <b>11</b> | <b>15</b> | <b>22</b> | <b>30</b> | <b>37</b> |
|   | 415-440V kW                       | 4,5             | 8,5        | 12        | 16        | 24        | 33        | 40        |
|   | 500V kW                           | 5,5             | 10         | 15        | 18,5      | 30        | 37        | 45        |
|   | 660-690V kW                       | 5,5             | 10         | 15        | 18,5      | 30        | 37        | 45        |
| <b>Cable cross-sections</b>                           |                                   |                 |            |           |           |           |           |           |
| Line  | solid or stranded                 | mm <sup>2</sup> | 0,75 - 6   |           | 1,5 - 25  |           | 4 - 50    |           |
|   | flexible                          | mm <sup>2</sup> | 1 - 4      |           | 2,5 - 16  |           | 6 - 35    |           |
|   | flexible with multicore cable end | mm <sup>2</sup> | 0,75 - 4   |           | 1,5 - 16  |           | 6 - 35    |           |
| Cables per clamp                                      |                                   |                 | 1          |           | 1         |           | 1         |           |
| <b>Power consumption of the combination</b>           |                                   |                 |            |           |           |           |           |           |
| inrush and change-over sealed                         | VA                                | 33 - 45         |            | 90 - 115  |           | 140 - 185 |           |           |
|   | VA                                | 7 - 10          |            | 9 - 13    |           | 13 - 18   |           |           |
|   | W                                 | 2,6 - 3         |            | 2,7 - 4   |           | 5,4 - 7   |           |           |

## Technical Data according to UL508

| Main Contacts (cULus)                                       | Type        | KNW3-10 | KNW3-18 | KW3-24 | KW3-32  | KW3-40 |
|---|-------------|---------|---------|--------|---------|--------|
| Rated operational power of three-phase motors at 60Hz (3ph) | 110-120V hp | 1½      | 2       | 5      | 5       | 7½     |
|   | 200V hp     | 3       | 5       | 7½     | 10      | 10     |
|   | 220-240V hp | 3       | 7½      | 10     | 10      | 15     |
|   | 277V hp     | 3       | 7½      | 7½     | 10      | 15     |
|   | 380-415V hp | 5       | 10      | 10     | 15      | 20     |
|   | 440-480V hp | 5       | 10      | 15     | 20      | 25     |
|   | 550-600V hp | 7½      | 15      | 20     | 25      | 30     |
| Fuse / Short-circuit current                                | A/kA        | 30/5    | 50/5    | 90/5   | 125/5   | 175/5  |
| Rated voltage   | V           | 600     | 600     | 600    | 600     | 600    |
| <b>Auxiliary Contacts (cULus)</b>                           |             | A600    | A600    | A600   | A600    | A600   |
| <b>Cable cross-sections</b>                                 |             |         |         |        |         |        |
| for main connectors   | solid       | AWG     | 18 - 10 |        | 16 - 10 |        |
|   | flexible    | AWG     | 18 - 10 |        | 14 - 4  |        |
| Cables per clamp  |             |         | 1       |        | 1       |        |

1) Suitable for: earthed-neutral systems, overvoltage category I to IV, pollution degree 3 (standard-industry):  $U_{mp} = 8kV$ . Data for other conditions on request.

# Pole Changing Starters

Data according to IEC 947-4-1, VDE 0660, EN 60947-4-1

| Type  |   | K3NPU18    | K3NPU24   | K3PU32    | K3PU50    | K3PU62    |
|---|---|------------|-----------|-----------|-----------|-----------|
| <b>Main Contacts</b>                                  |   |            |           |           |           |           |
| Rated insulation voltage $U_i$ <sup>1)</sup>          | V AC  | 690        | 690       | 690       | 690       | 690       |
| <b>Utilization category AC3</b>                       |   |            |           |           |           |           |
| <b>Switching of three-phase motors</b>                |   |            |           |           |           |           |
| Rated operational current $I_e$                       | 220V A  | 18         | 23        | 30        | 45        | 63        |
|   | 230V A  | 17,5       | 23        | 30        | 45        | 60        |
|   | 240V A  | 17         | 23        | 30        | 45        | 60        |
|   | <b>380-400V A</b>                                 | <b>16</b>  | <b>23</b> | <b>30</b> | <b>45</b> | <b>60</b> |
|   | 415V A  | 16         | 23        | 30        | 45        | 60        |
|   | 440V A  | 16         | 23        | 30        | 45        | 60        |
|   | 500V A  | 16         | 23        | 30        | 45        | 55        |
|   | 660V A  | 9          | 17,5      | 21        | 33        | 42        |
|   | 690V A  | 8,5        | 17        | 20        | 31        | 40        |
| Rated operational power of three-phase motors 50-60Hz | 220-230V kW                                       | 5          | 6         | 8,5       | 12,5      | 18,5      |
|   | 240V kW   | 5          | 7         | 9         | 13,5      | 19        |
|   | <b>380-400V kW</b>                                | <b>7,5</b> | <b>11</b> | <b>15</b> | <b>22</b> | <b>30</b> |
|   | 415-440V kW                                       | 8,5        | 12        | 16        | 24        | 33        |
|   | 500V kW   | 10         | 15        | 18,5      | 30        | 37        |
|   | 660-690V kW                                       | 7,5        | 15        | 18,5      | 30        | 37        |
| <b>Cable cross-sections</b>                           |   |            |           |           |           |           |
| Line  | solid or stranded mm <sup>2</sup>                 | 0,75 - 6   | 1,5 - 25  |           | 4 - 50    |           |
|   | flexible mm <sup>2</sup>                          | 1 - 4      | 2,5 - 16  |           | 6 - 35    |           |
|   | flexible with multicore cable end mm <sup>2</sup> | 0,75 - 4   | 1,5 - 16  |           | 6 - 35    |           |
| Cables per clamp                                      |   | 1          | 1         |           | 1         |           |
| <b>Power consumption of the combination</b>           |   |            |           |           |           |           |
|   | inrush and change-over VA                         | 55         | 128       |           | 178       |           |
|   | sealed VA   | 20         | 26        |           | 31        |           |
|   | W   | 6          | 8         |           | 11        |           |

1) Suitable for: earthed-neutral systems, overvoltage category I to IV, pollution degree 3 (standard-industry):  $U_{imp} = 8kV$ . Data for other conditions on request.

# Star-Delta Starters

## Wiring Diagrams Main Circuit

Terminal markings of contactors and relays according to DIN EN 50012  
Connections shown in main and circuits as broken lines are not included.

### K3NY15 to K3Y100

with thermal overload relay U3/.. or U12/16

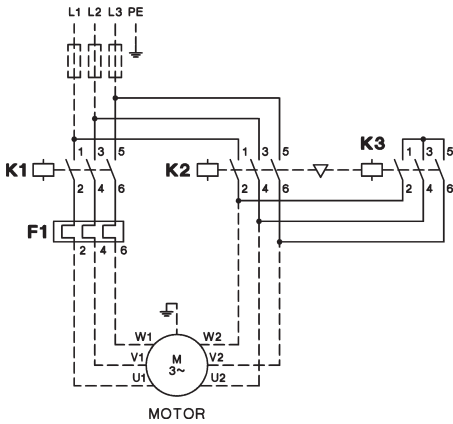

### K3Y140 to K3Y300

with thermal overload relay U85 or U180

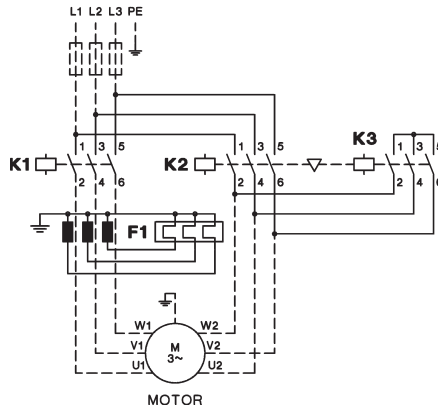

## Wiring Diagrams Control Circuit

### K3NY15 to K3Y52

operating with control switch

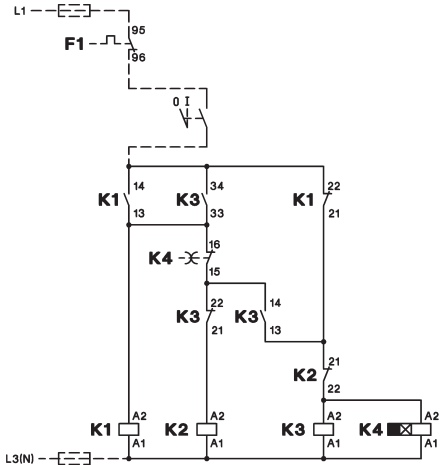

### K3NY15 to K3Y52

operating with push buttons

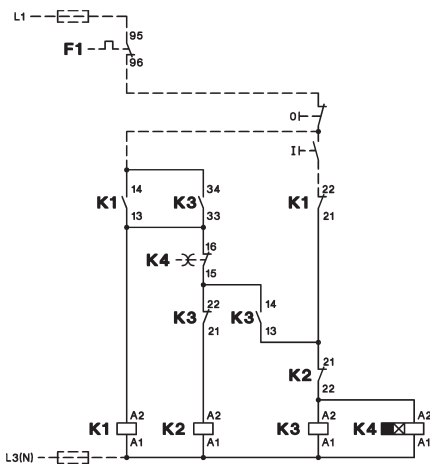

### K3Y80 to K3Y200

operating with control switch

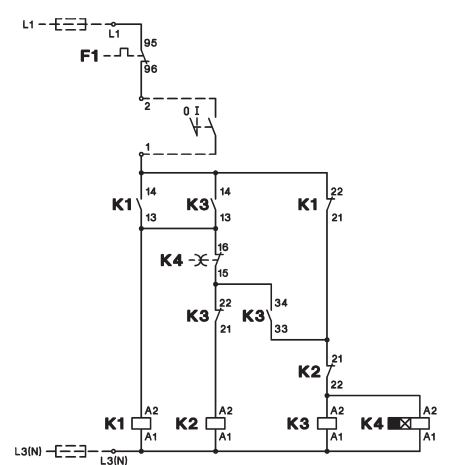

### K3Y80 to K3Y200

operating with push buttons

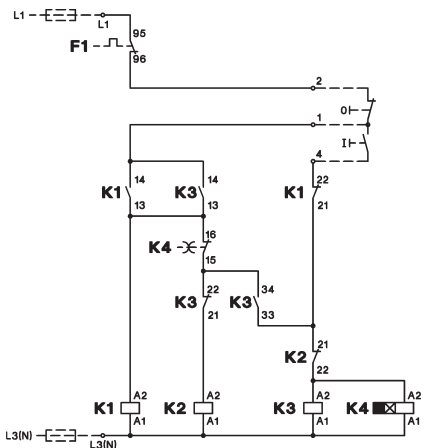

### K3Y240 to K3Y300

operating with control switch

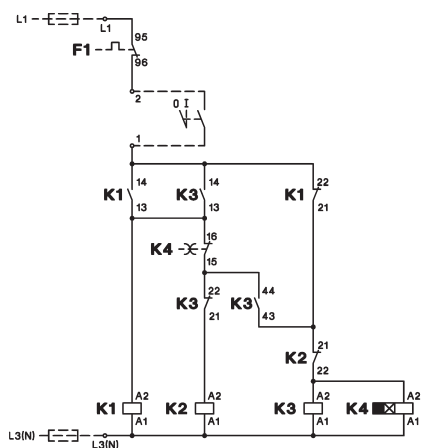

### K3Y240 to K3Y300

operating with push buttons

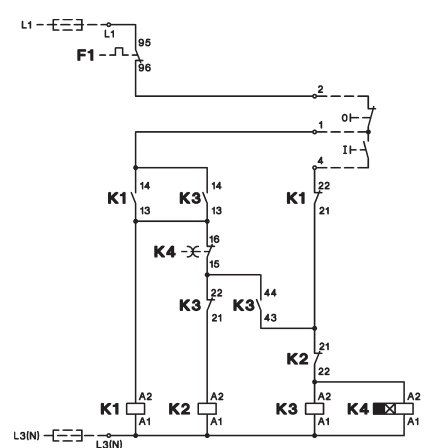

# Star-Delta Starters

## Wiring Diagrams Main Circuit

Terminal markings of contactors and relays according to DIN EN 50012  
 Connections shown in main and control circuits as broken lines are not included.

### K3YL..

Typical circuit diagram

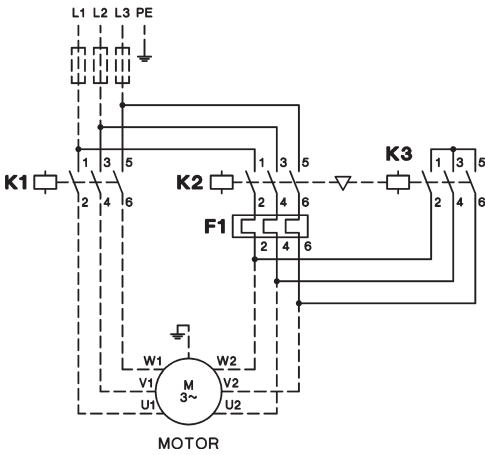

### K3Y.. with 2 Thermal Overload Relays

Typical circuit diagram

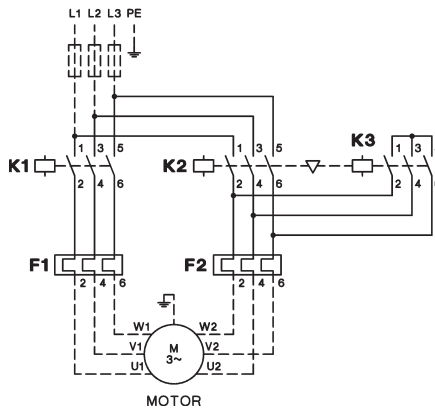

## Wiring Diagrams Control Circuit

### with selector switch

#### K3Y..W

Typical circuit diagram  
 operating with control switch

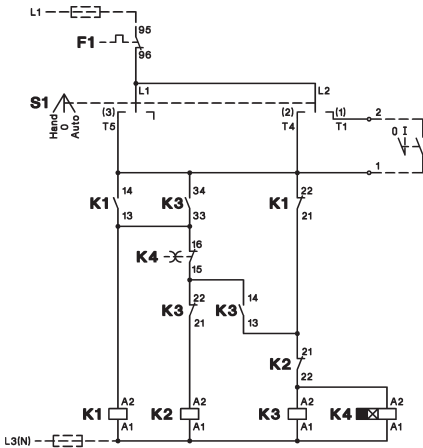

Typical circuit diagram  
 operating with push buttons

### with push buttons

#### K3Y..T

Typical circuit diagram

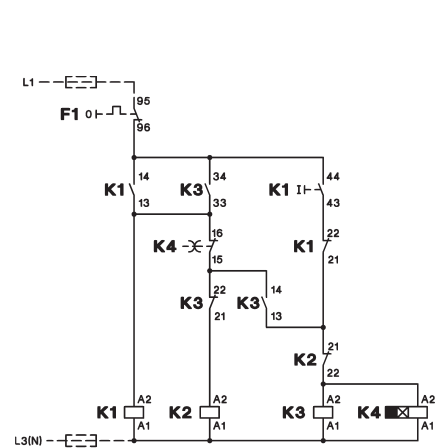
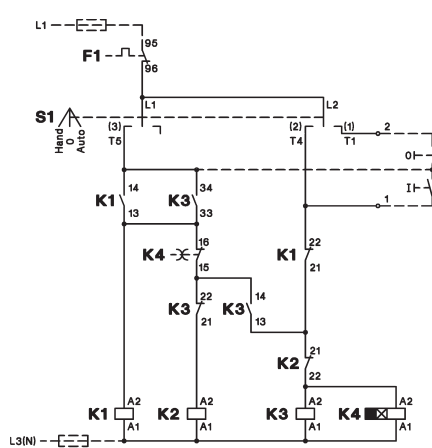

# Reversing Contactors

## Wiring Diagrams Main Circuit

Terminal markings of contactors and relays according to DIN EN 50012  
 Connections shown in main and control circuits as broken lines are not included.

### K3NWU10 to K3WU74

with thermal overload relay U3/32, U3/42 or U3/74

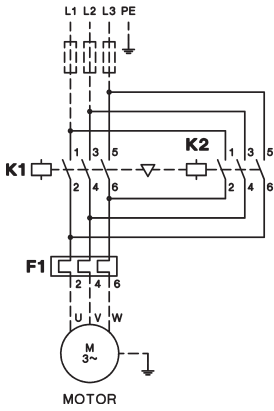

## Wiring Diagrams Control Circuit

### K3NWU10 to K3WU32

operating with control switch

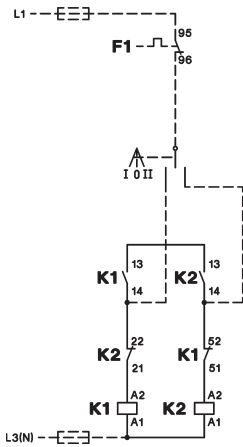

operating with push buttons  
**Reversing over off-position**

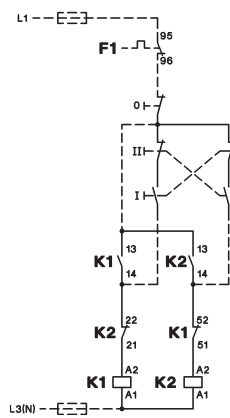

**Reversing direct**

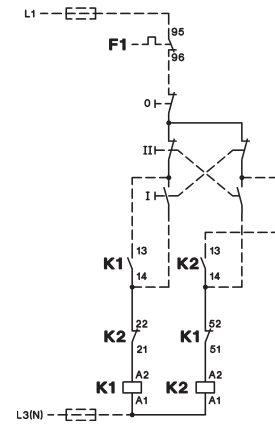

### K3WU50, K3WU62, K3WU74

operating with control switch

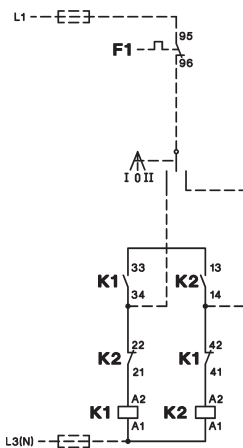

operating with push buttons

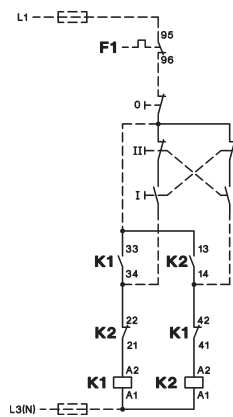



# Pole Changing Starters

## Wiring Diagrams

Terminal markings of contactors and relays according to DIN EN 50012  
 Connections shown in main and control circuits as broken lines are not included.

### Main Circuit

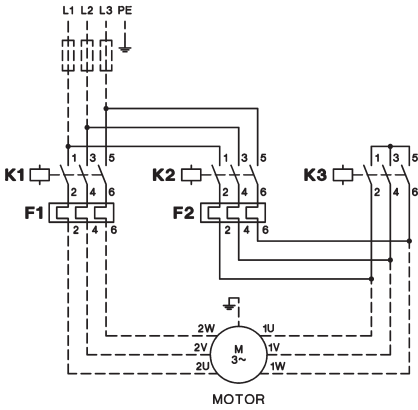

### Principal Control Circuit Wiring Diagram

operating with control switch

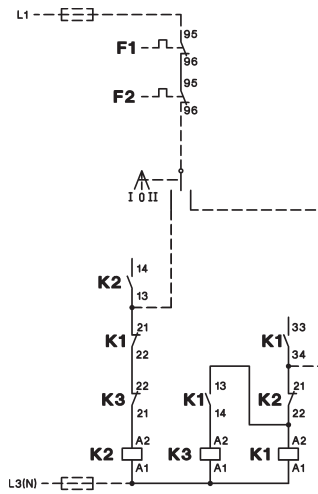

operating with push buttons

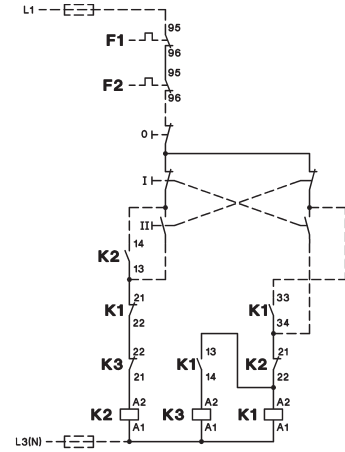

|                | Low speed | High speed  | Low speed | High speed  |
|----------------|-----------|-------------|-----------|-------------|
| Operation      | Delta     | Double-Star | Star      | Double-Star |
| Speed relation | 1         | 2           | 1         | 2           |
| Power relation | 1         | 1,5 - 1,8   | 0,3       | 1           |

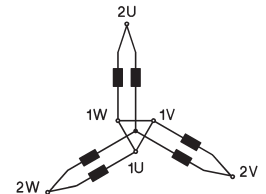
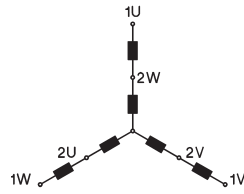
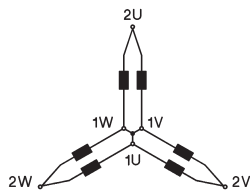
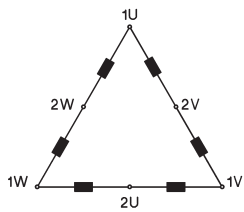

# Star-Delta Starters

## Dimensions

Star-Delta Starters, AC operated, open type

**K3NY15 + U3/32**  
**K3NY26**

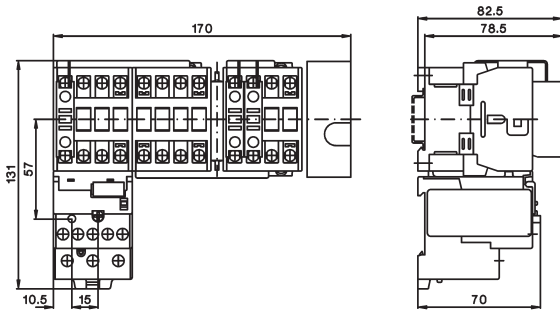

**K3NY15 + U12/16E G3**  
**K3NY26**

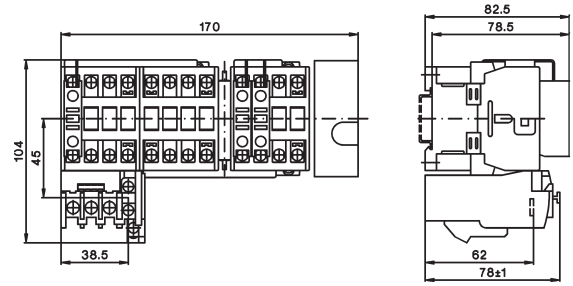

**K3Y40 + U3/32**  
**K3Y52 + U3/32**

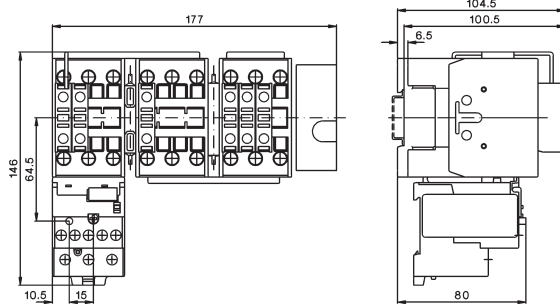

**K3Y40 + U3/42**  
**K3Y52 + U3/42**

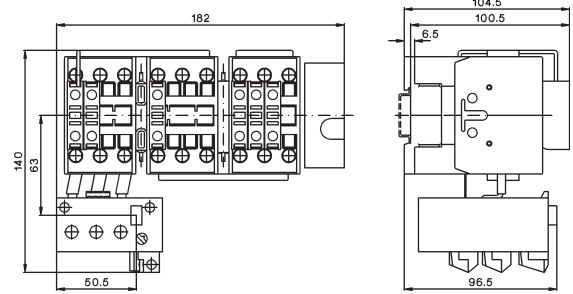

**K3Y80 + U3/74**

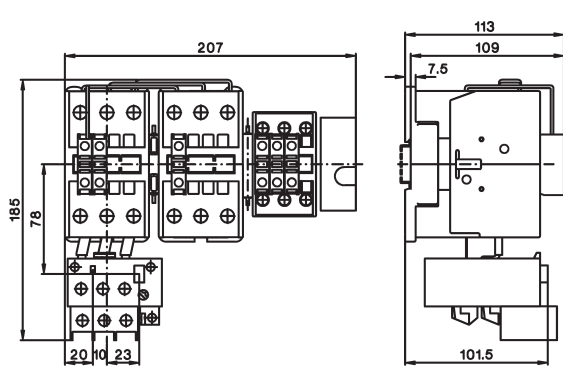

**K3Y100 + U3/74**

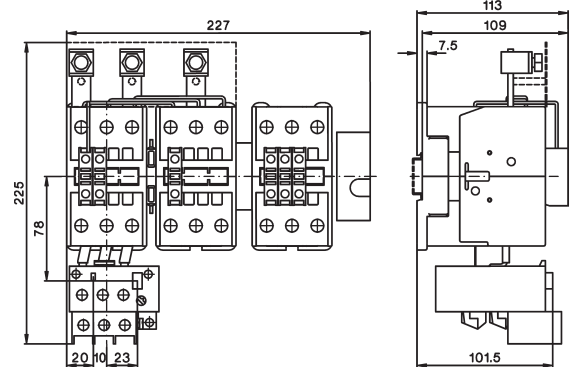

**K3Y140 + U85**  
**K3Y200**

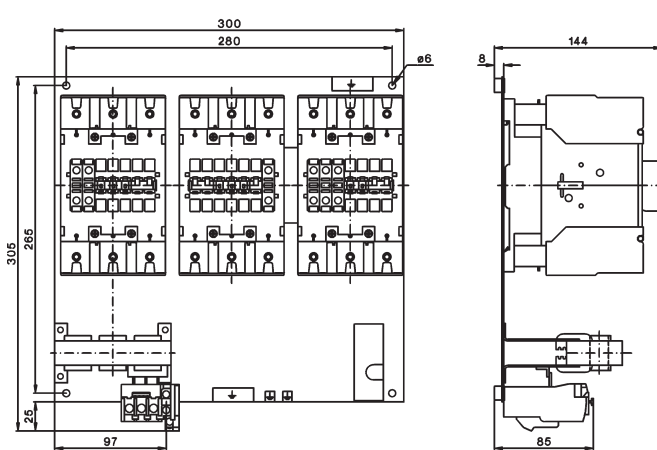

**K3Y240 + U180 + SU180/176**  
**K3Y300**

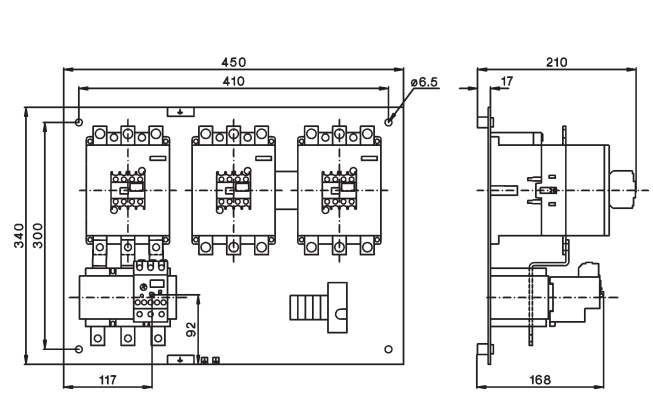

# Star-Delta Starters

## Dimensions

Star-Delta Starters, plastic enclosed, protected to IP65

### K3NY26P

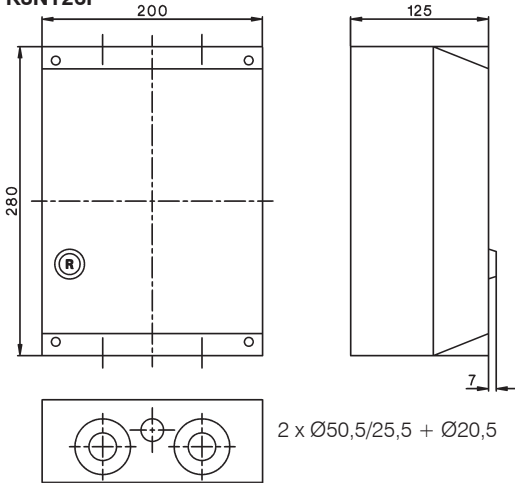

### K3Y40P to K2Y100P

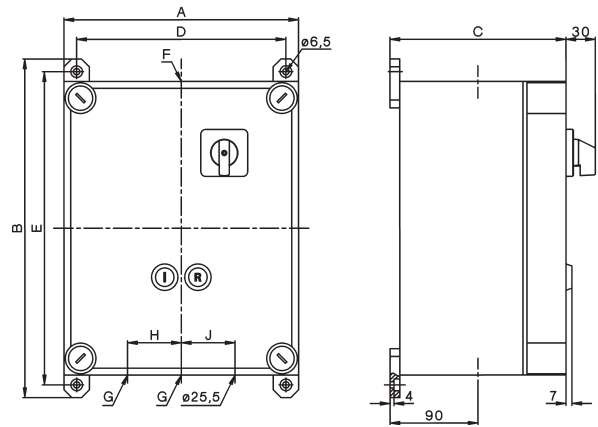

| Type           | A   | B   | C   | D   | E   | Ø F | Ø G  | H    | J  |    |
|----------------|-----|-----|-----|-----|-----|-----|------|------|----|----|
| <b>K3Y40P</b>  | 300 | 346 | 180 | 272 | 320 | 6,5 | 32,5 | 32,5 | 60 | 60 |
| <b>K3Y52P</b>  | 300 | 346 | 180 | 272 | 320 | 6,5 | 32,5 | 32,5 | 60 | 60 |
| <b>K3Y80P</b>  | 300 | 446 | 180 | 272 | 420 | 6,5 | 40,5 | 40,5 | 70 | 70 |
| <b>K3Y100P</b> | 300 | 446 | 180 | 272 | 420 | 6,5 | 50,5 | 40,5 | 70 | 70 |

Star-Delta Starters, sheet steel enclosed, protected to IP54

### K3Y26B to K3Y52B

| Type           | Ø F  | Ø G  |
|----------------|------|------|
| <b>K3NY26B</b> | 25,5 | 25,5 |
| <b>K3Y40B</b>  | 32,5 | 32,5 |
| <b>K3Y52B</b>  | 32,5 | 32,5 |

Mounting by included fixing link

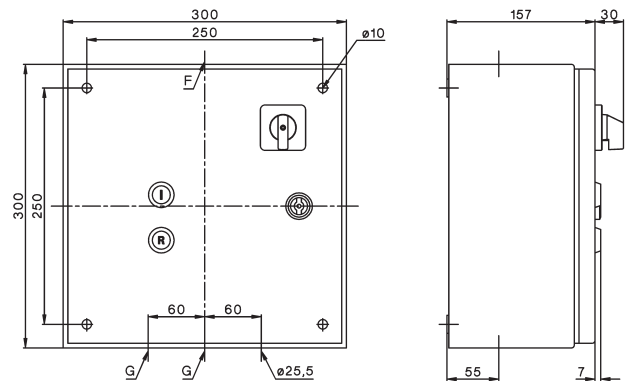
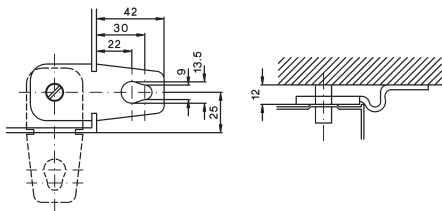

### K3Y80B to K2Y200B

| Type           | A   | B   | C   | D   | E   | L   | M  |
|----------------|-----|-----|-----|-----|-----|-----|----|
| <b>K3Y80B</b>  | 380 | 380 | 210 | 340 | 340 | 8,7 | 65 |
| <b>K3Y100B</b> | 380 | 380 | 210 | 340 | 340 | 8,7 | 65 |
| <b>K3Y140B</b> | 380 | 600 | 210 | 560 | 340 | 8,7 | 65 |
| <b>K3Y200B</b> | 380 | 600 | 210 | 560 | 340 | 8,7 | 65 |

| Type           | Ø F  | Ø G  | H  | J  | K  |
|----------------|------|------|----|----|----|
| <b>K3Y80B</b>  | 40,5 | 40,5 | 70 | 70 | 60 |
| <b>K3Y100B</b> | 50,5 | 40,5 | 80 | 70 | 60 |
| <b>K3Y140B</b> | 50,5 | 50,5 | 80 | 80 | 70 |
| <b>K3Y200B</b> | 50,5 | 50,5 | 80 | 80 | 70 |

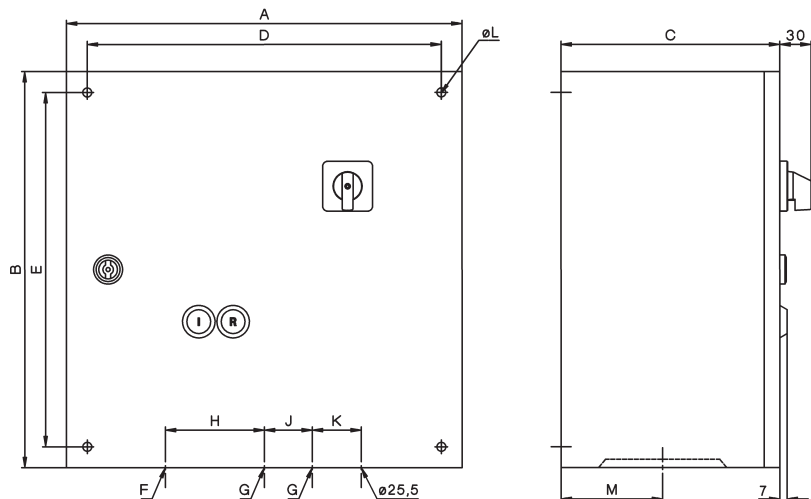

# Reversing Contactors

## Dimensions

Reversing Starters, AC operated, open type

**K3NWU10 + U3/32**  
**K3NWU18**

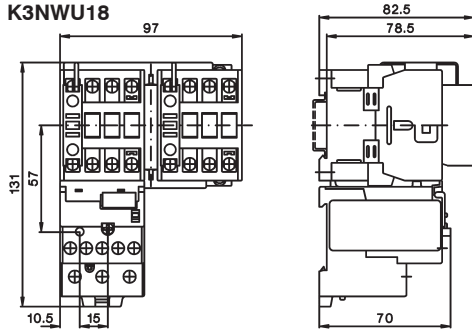

**K3NWU10 + U12/16E G3**  
**K3NWU18**

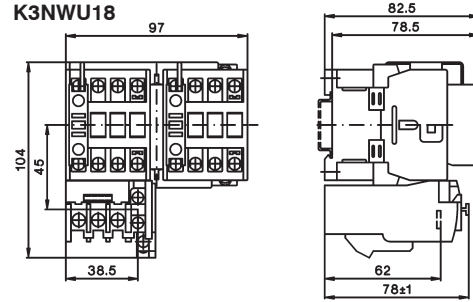

**K3WU24 + U3/32**  
**K3WU32**  
**K3WU40**

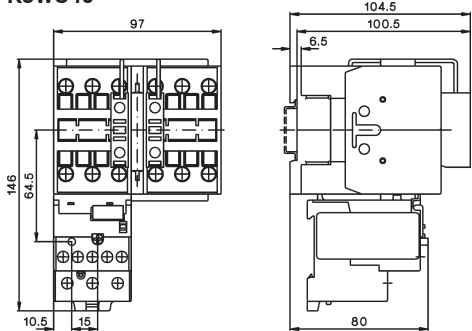

**K3WU24 + U3/42**  
**K3WU32**  
**K3WU40**

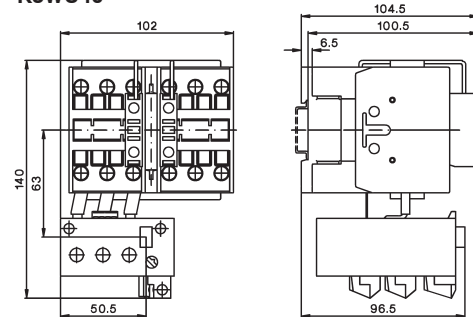

**K3WU50 + U3/74**  
**K3WU62**  
**K3WU74**

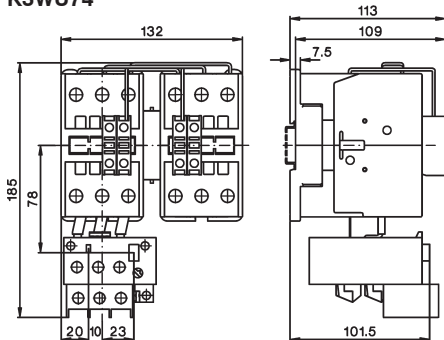

Reversing Contactors, sheet steel enclosed, protected to IP54

| Type            | A   | B   | C   | D   | E   | F  | G  | H     | K  |
|-----------------|-----|-----|-----|-----|-----|----|----|-------|----|
| <b>K3NWU18B</b> | 300 | 300 | 150 | 250 | 250 | 30 | 30 | Ø25,5 | 41 |
| <b>K3WU24B</b>  | 300 | 300 | 150 | 250 | 250 | 30 | 30 | Ø32,5 | 41 |
| <b>K3WU32B</b>  | 300 | 300 | 150 | 250 | 250 | 30 | 30 | Ø32,5 | 41 |
| <b>K3WU50B</b>  | 300 | 300 | 150 | 250 | 250 | 40 | 40 | Ø32,5 | 59 |
| <b>K3WU62B</b>  | 300 | 300 | 150 | 250 | 250 | 40 | 40 | Ø32,5 | 59 |

Mounting by included fixing link

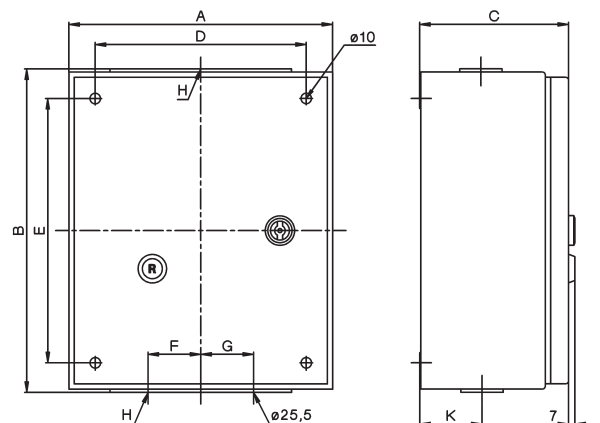
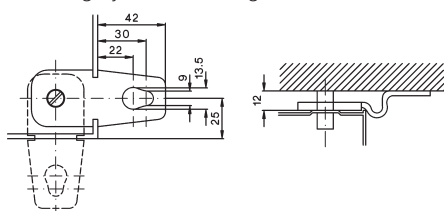

# Pole Changing Starters

## Dimensions

Pole Changing Starters, AC operated, open type

**K3NPU18 + 2x U3/32**

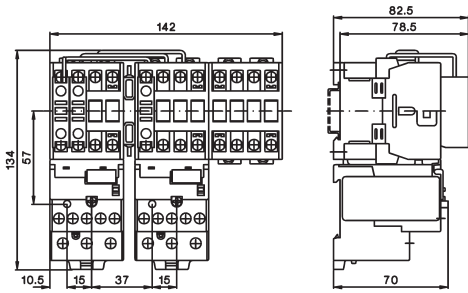

**K3NPU18 + 2x U12/16**

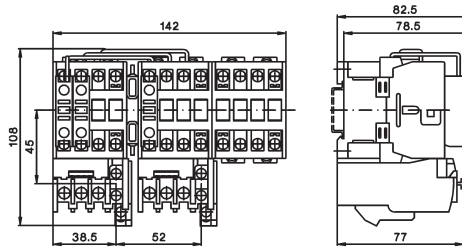

**K3PU24 + 2x U3/32  
K3PU32**

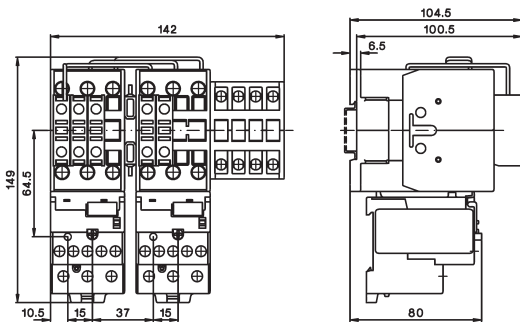

**K3PU50 + 2x U3/74  
K3PU62**

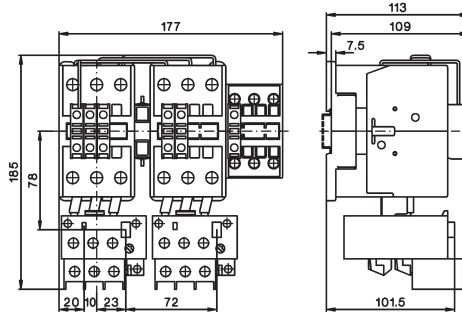

Pole Changing Starters, sheet steel enclosed, protected to IP54

**K3NPU18B to K3PU32B**

| Type            | Ø F  | Ø G  |
|-----------------|------|------|
| <b>K3NPU18B</b> | 25,5 | 25,5 |
| <b>K3PU24B</b>  | 32,3 | 32,5 |
| <b>K3PU32B</b>  | 32,3 | 32,5 |

Mounting by included fixing link

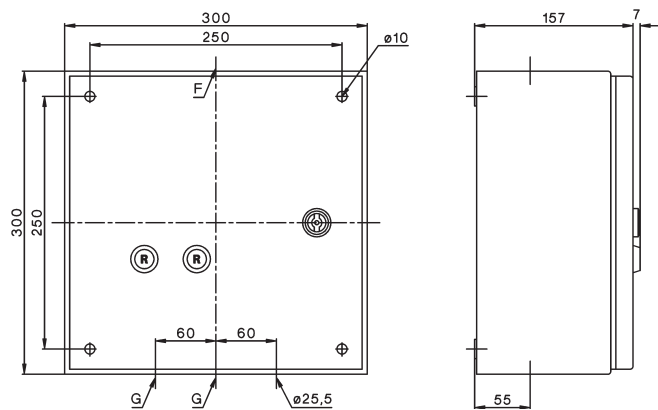
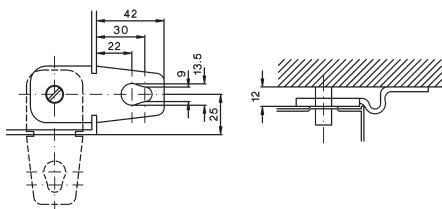



D.O.L. Starters With Start-Stop Buttons

112



D.O.L. Starters With Selector Switch

112



D.O.L. Starters With Selector Switch And Pneumatic Switch For Use In Moist Rooms

112



Enclosures

113



Accessories

113

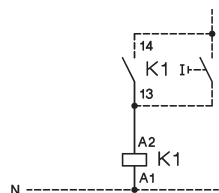

Wiring Diagrams

115

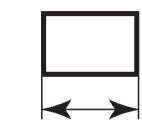

Dimensions

116

## D.O.L. Starters In Plastic Enclosure

| Ratings     | Included | Free    | order    | Protec- | Conduit | Type | Coil voltage <sup>1)</sup> | Pack | Weight |
|-------------|----------|---------|----------|---------|---------|------|----------------------------|------|--------|
| AC3 at      | Contact  | Space   | extra    | tion    | Entries |      |                            | pcs. | kg/pc. |
| <b>380V</b> |          | f. Aux. |          | Degree  |         |      | <b>230</b> 220-240V 50Hz   |      |        |
| <b>400V</b> |          | Cont.   | Overload |         |         |      | <b>400</b> 380-415V 50Hz   |      |        |
| <b>415V</b> |          | HN..    | Relay    |         |         |      |                            |      |        |
| <b>kW</b>   | Type     | pcs.    | Type     |         |         |      |                            |      |        |

## D.O.L. Starters with Start-Stop/Reset Push Buttons



|            |           |   |           |      |          |                  |   |     |
|------------|-----------|---|-----------|------|----------|------------------|---|-----|
| <b>4</b>   | K3-10ND10 | 2 | U12/16 K3 | IP65 | Ø 20,5mm | <b>P1T10</b> ... | 1 | 0,6 |
| <b>7,5</b> | K3-18ND10 | 2 | U12/16 K3 | IP65 | Ø 20,5mm | <b>P1T18</b> ... | 1 | 0,6 |
| <b>11</b>  | K3-22ND10 | 2 | U12/16 K3 | IP65 | Ø 20,5mm | <b>P1T22</b> ... | 1 | 0,6 |

## D.O.L. Starters with Selector Switch



|            |           |   |           |      |          |                  |   |     |
|------------|-----------|---|-----------|------|----------|------------------|---|-----|
| <b>4</b>   | K3-10ND10 | 2 | U12/16 K3 | IP65 | Ø 20,5mm | <b>P1W10</b> ... | 1 | 0,6 |
| <b>7,5</b> | K3-18ND10 | 2 | U12/16 K3 | IP65 | Ø 20,5mm | <b>P1W18</b> ... | 1 | 0,6 |
| <b>11</b>  | K3-22ND10 | 2 | U12/16 K3 | IP65 | Ø 20,5mm | <b>P1W22</b> ... | 1 | 0,6 |

## D.O.L. Starters with Selector Switch and Pneumatic Switch for moist rooms



|            |           |   |           |      |          |                   |   |     |
|------------|-----------|---|-----------|------|----------|-------------------|---|-----|
| <b>7,5</b> | K3-18ND10 | 2 | U12/16 K3 | IP65 | Ø 20,5mm | <b>P1W18P</b> ... | 1 | 0,6 |
|------------|-----------|---|-----------|------|----------|-------------------|---|-----|

Push button and tube on request

**Ordering Example:** D.O.L. Starter with selector switch, plastic enclosed, rated AC3 at 400V 15,5A, rated control voltage 230V 50Hz - **Order Type: P1W18 230 + U12/16E 18 K3**

## Pneumatic Button



|  |  |  |  |  |  |             |   |  |
|--|--|--|--|--|--|-------------|---|--|
|  |  |  |  |  |  | <b>P1LT</b> | 1 |  |
|--|--|--|--|--|--|-------------|---|--|

## Air Pressure Hose



|           |  |  |  |  |  |               |   |  |
|-----------|--|--|--|--|--|---------------|---|--|
| Length 5m |  |  |  |  |  | <b>P1LS-5</b> | 1 |  |
|-----------|--|--|--|--|--|---------------|---|--|

## Pneumatic Switch



|  |  |  |  |  |  |               |   |      |
|--|--|--|--|--|--|---------------|---|------|
| for refill of D.O.L. Starter P1W.. to P1W..P |  |  |  |  |  | <b>P1-LDR</b> | 1 | 0,02 |
|--|--|--|--|--|--|---------------|---|------|

## Thermal Overload Relays



| Setting range<br>A | Type                   | Pack<br>pcs. | Weight<br>kg/pc. |
|--------------------|------------------------|--------------|------------------|
| 0,12 - <b>0,18</b> | <b>U12/16E 0,18 K3</b> | 1            | 0,10             |
| 0,18 - <b>0,27</b> | <b>U12/16E 0,27 K3</b> | 1            | 0,10             |
| 0,27 - <b>0,4</b>  | <b>U12/16E 0,4 K3</b>  | 1            | 0,10             |
| 0,4 - <b>0,6</b>   | <b>U12/16E 0,6 K3</b>  | 1            | 0,10             |
| 0,6 - <b>0,9</b>   | <b>U12/16E 0,9 K3</b>  | 1            | 0,10             |
| 0,8 - <b>1,2</b>   | <b>U12/16E 1,2 K3</b>  | 1            | 0,10             |
| 1,2 - <b>1,8</b>   | <b>U12/16E 1,8 K3</b>  | 1            | 0,10             |
| 1,8 - <b>2,7</b>   | <b>U12/16E 2,7 K3</b>  | 1            | 0,10             |
| 2,7 - <b>4</b>     | <b>U12/16E 4 K3</b>    | 1            | 0,10             |
| 4 - <b>6</b>       | <b>U12/16E 6 K3</b>    | 1            | 0,10             |
| 6 - <b>9</b>       | <b>U12/16E 9 K3</b>    | 1            | 0,10             |
| 8 - <b>11</b>      | <b>U12/16E 11 K3</b>   | 1            | 0,10             |
| 10 - <b>14</b>     | <b>U12/16E 14 K3</b>   | 1            | 0,10             |
| 13 - <b>18</b>     | <b>U12/16E 18 K3</b>   | 1            | 0,10             |
| 17 - <b>23</b>     | <b>U12/16E 23 K3</b>   | 1            | 0,10             |
| 22 - <b>30</b>     | <b>U12/16E 30 K3</b>   | 1            | 0,13             |

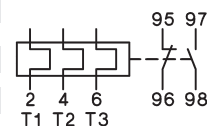

manual reset

## Overload Relays with Quick Tripping Characteristic see page 120,121

Technical data see contactors page 62 and thermal overload relays page 125  
1) Non-standard coil voltages see page 57

## Enclosures for Contactors



| Suitable for contactor   | Protection Degree | Conduit Entries Top | Conduit Entries Bottom | Type      | Pack pcs. | Weight kg/pc. |
|--|-------------------|---------------------|------------------------|-----------|-----------|---------------|
| <b>K3-07.. to K3-22..<br/>K3-24..<sup>1)</sup> to K3-40..<sup>1)</sup></b> | IP65              | 2 x Ø 20,5mm        | 2 x Ø 20,5mm           | <b>P1</b> | 1         | 0,35          |

with Reset Button



| Suitable for contactor                     | Protection Degree | Conduit Entries Top | Conduit Entries Bottom | Type       | Pack pcs. | Weight kg/pc. |
|--|-------------------|---------------------|------------------------|------------|-----------|---------------|
| <b>K3-10.. to K3-22..<br/>+U12/16.. K3</b> | IP65              | 2 x Ø 20,5mm        | 2 x Ø 20,5mm           | <b>P1R</b> | 1         | 0,35          |

with Selector Switch



| Suitable for contactor                     | Protection Degree | Conduit Entries Top | Conduit Entries Bottom | Type       | Pack pcs. | Weight kg/pc. |
|--|-------------------|---------------------|------------------------|------------|-----------|---------------|
| <b>K3-10.. to K3-22..<br/>+U12/16.. K3</b> | IP65              | 2 x Ø 20,5mm        | 2 x Ø 20,5mm           | <b>P1W</b> | 1         | 0,35          |

with Start-Stop Push Button



| Suitable for contactor                     | Protection Degree | Conduit Entries Top | Conduit Entries Bottom | Type       | Pack pcs. | Weight kg/pc. |
|--|-------------------|---------------------|------------------------|------------|-----------|---------------|
| <b>K3-10.. to K3-22..<br/>+U12/16.. K3</b> | IP65              | 2 x Ø 20,5mm        | 2 x Ø 20,5mm           | <b>P1T</b> | 1         | 0,35          |

## Indicator Units



| Specifications   | Voltage Range    | Type          | Pack pcs. | Weight kg/pc. |
|--|------------------|---------------|-----------|---------------|
| <b>Coil Current Indicator</b> , green (LED)  | 24 - 660V AC/DC  | <b>K2-ING</b> | 10        | 0,02          |
| <b>Coil Current Indicator</b> , red (LED)  | 24 - 660V AC/DC  | <b>K2-INR</b> | 10        | 0,02          |
| To be connected in series with the contactor coil. In case of coil interruption the indicator goes out. Voltage drop approx. 2 volts |                  |               |           |               |
| <b>Voltage Indicator</b> , clear (glow-disc. I.)   | 220 - 415V AC/DC | <b>K2-UN</b>  | 10        | 0,02          |
| <b>Voltage Indicator</b> , red (LED)   | 24 - 120V AC/DC  | <b>K2-UNR</b> | 10        | 0,02          |
| To be connected parallel to the contactor coil. In case of applied voltage the indicator also lights at coil interruption.           |                  |               |           |               |

### Lens Caps For Indicator Units



|                      |                 |    |       |
|----------------------|-----------------|----|-------|
| Lens cap transparent | <b>LG9743T</b>  | 10 | 0,005 |
| Lens cap red         | <b>LG9743R</b>  | 10 | 0,005 |
| Lens cap green       | <b>LG9743GR</b> | 10 | 0,005 |

Mounting instructions see page 118

## Heating Element



| Specifications   | Voltage Range | Power Consumption | Type             | Pack pcs. | Weight kg/pc. |
|--|---------------|-------------------|------------------|-----------|---------------|
| To avoid condensed water on places where high humidity is given together with alterations of ambient temperature | 380 - 415V    | 1,5W              | <b>K2-HR</b>     | 10        | 0,02          |
|  | 220 - 240V    | 1,5W              | <b>K2-HR 230</b> | 10        | 0,02          |

## Additional Terminals, Start Contact



| Specification                      | Cable Cross-sections to clamp mm <sup>2</sup> |   |                                 | Type             | Pack pcs. | Weight kg/pc. |
|------------------------------------|---|---|---------------------------------|------------------|-----------|---------------|
|                                    | solid or stranded                             | flexible                                      | flexib. w. multi-core cable end |                  |           |               |
| <b>Neutral Terminal</b>            | 2 x 0,75-4                                    | 2 x 0,75-2,5                                  | 2 x 0,5-2,5                     | <b>LG9744</b>    | 10        | 0,009         |
| <b>Earth Terminal</b>              | 2,5-16  | 1,5-10  | 1,5-10                          | <b>LG9750</b>    | 10        | 0,052         |
| Mounting instructions see page 116 |   |   |                                 |                  |           |               |
| <b>Start Contact</b>               | for contactor K3-10 to K3-22                  | to be snapped on top of the auxiliary contact |                                 | <b>LG9319-K3</b> | 10        | 0,03          |

<sup>1)</sup> without auxiliary contact blocks



# D.O.L. Starters

## Wiring Diagrams Main Circuit

All fuses F0 shown in the main circuits are not included.  
Terminal markings according to EN 50012

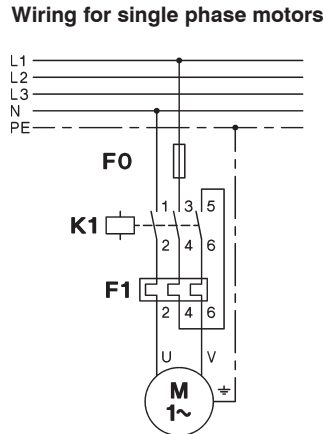
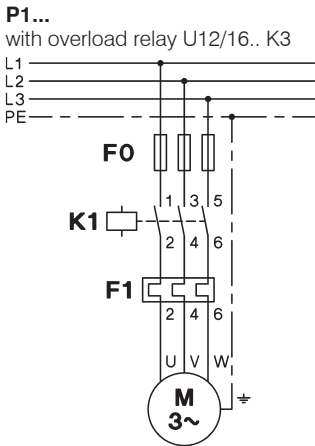

## Wiring Diagrams Control Circuit

D.O.L. Starters P1 with standard coil voltages (see page 94) are supplied with connectors between main circuit and control circuit.

### Coil connectors

Coils for **380-415V 50Hz** and **400-440V 60Hz**: The starter is supplied with control circuit connectors between terminals 1 (L1) and 5 (L3).  
Coils for **220-240V 50Hz** and **230-264V 60Hz**: The starter is supplied with control circuit connectors between terminals 95 and 5 (L3). Connect neutral wire to terminal A1.  
Coils for **other voltages**: Without connectors between supply and control circuit. Connect supply to terminals A1 and 95.

### Separate coil supply

Coils for **380-415V 50Hz** and **400-440V 60Hz**: Remove connectors A1-1 and 95-5, connect supply to terminals A1 and 95.  
Coils for **220-240V 50Hz** and **230-264V 60Hz**: Remove connectors 95-5 connect supply to terminals A1 and 95.  
Coils for **other voltages**: Connect supply to terminals A1 and 95.

### Coil phase to phase (380-415V 50Hz)

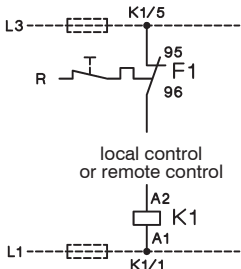

### Coil phase to neutral (220-240V 50Hz)

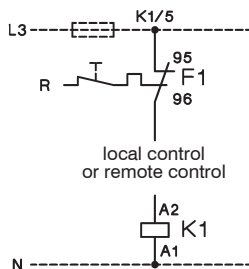

### Coil phase to phase

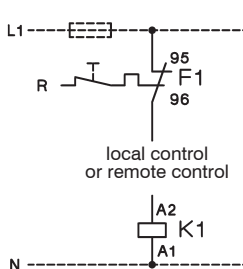

### Coil phase to neutral

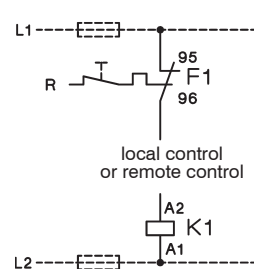

## D.O.L. Starters with remote control

**P1..**  
Remote 2-wire (switch) control

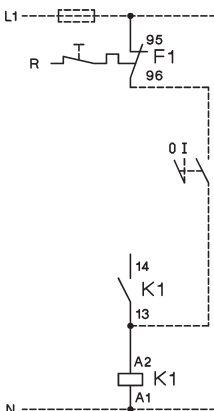

Remote 3-wire (push button) control

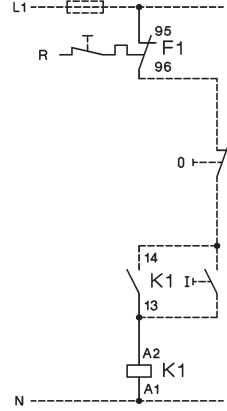

Remote start-stop control  
(3 control stations)

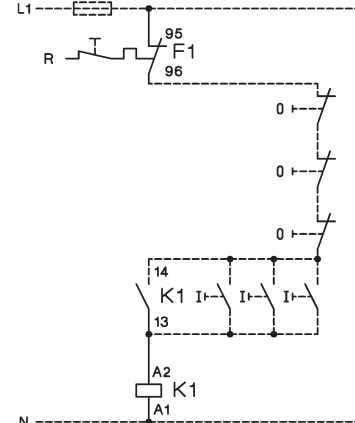

# D.O.L. Starters

## Wiring Diagrams Control Circuits

Typical circuit diagram (for separate coil supply, control circuit connected between L1 and N)  
Terminal markings according to EN 50012

### D.O.L. Starters with Start-Stop/Reset Push Buttons

**P1T10, P1T18, P1T22**  
with overload relay U12/16.. K3

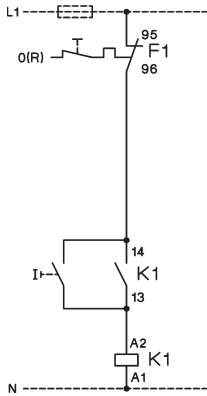

**P1T10, P1T18, P1T22**  
with external push buttons

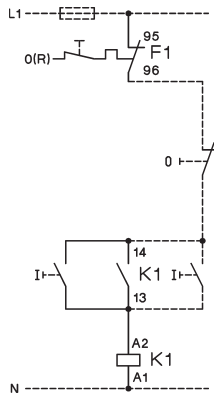

### D.O.L. Starters with Selector Switch

**P1W10, P1W18, P1W22**  
with external control switch

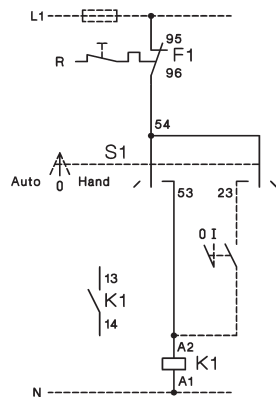

**P1W10, P1W18, P1W22**  
with external push buttons

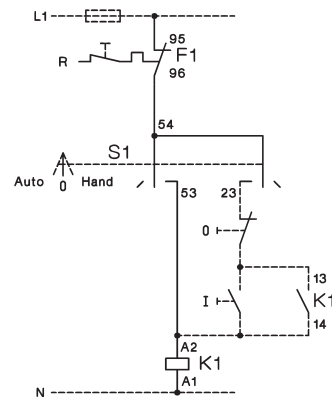

### D.O.L. Starters with Selector Switch and Pneumatic Switch for Swimmingpool Control Gear and for use in Moist Rooms

**P1W18P**  
with overload relay U12/16.. K3

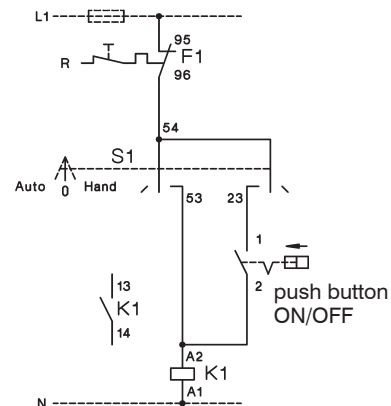

# D.O.L. Starters

## Dimensions

D.O.L. Starters with Start-Stop/Reset Push Buttons, Plastic Enclosed

P1T., P1TP.

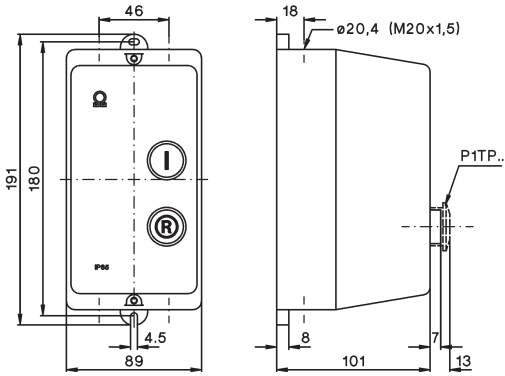

D.O.L. Starters with Selector Switch, Plastic Enclosed

P1W., P1W18P

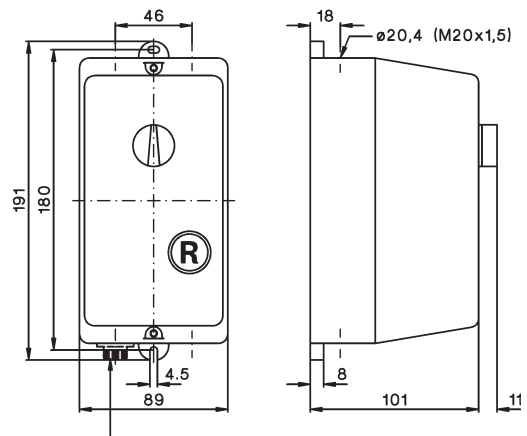

P1W18P: plug-in for air tube inside diameter 3mm

## Rear Conduit Entries

knockouts  
4 x Ø 23

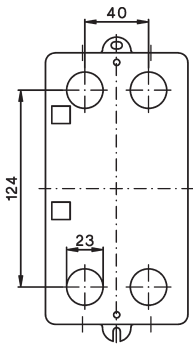

## Earth Terminal LG9750 for K2-23 and K2-30 in Enclosure P1

for K2-23 and K2-30 remove spacing piece

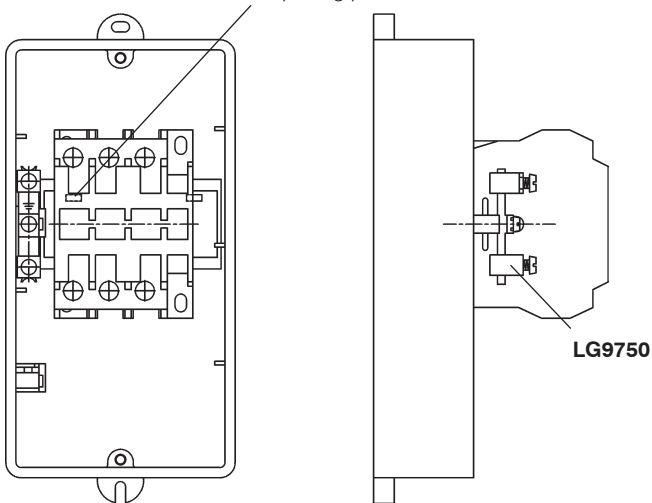

## Neutral Terminal LG9744

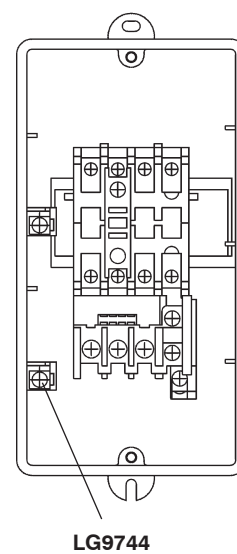

# Enclosures

## Dimensions

### Enclosures for Contactors

P1

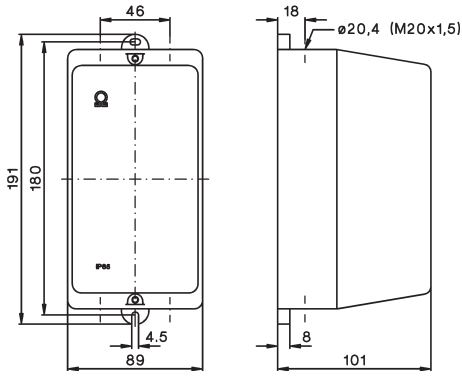

### Enclosures for D.O.L. Starters

P1R, P1P

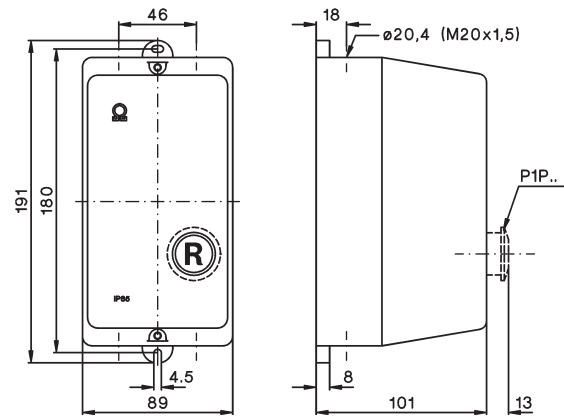

### Rear Conduit Entries

knockouts  
4 x  $\phi 23$

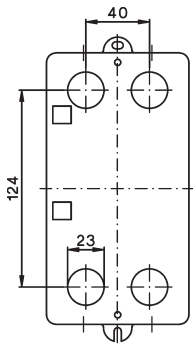

# D.O.L. Starters

## Mounting and Wiring Instructions

Indicators and Lens Caps for D.O.L. Starters P1

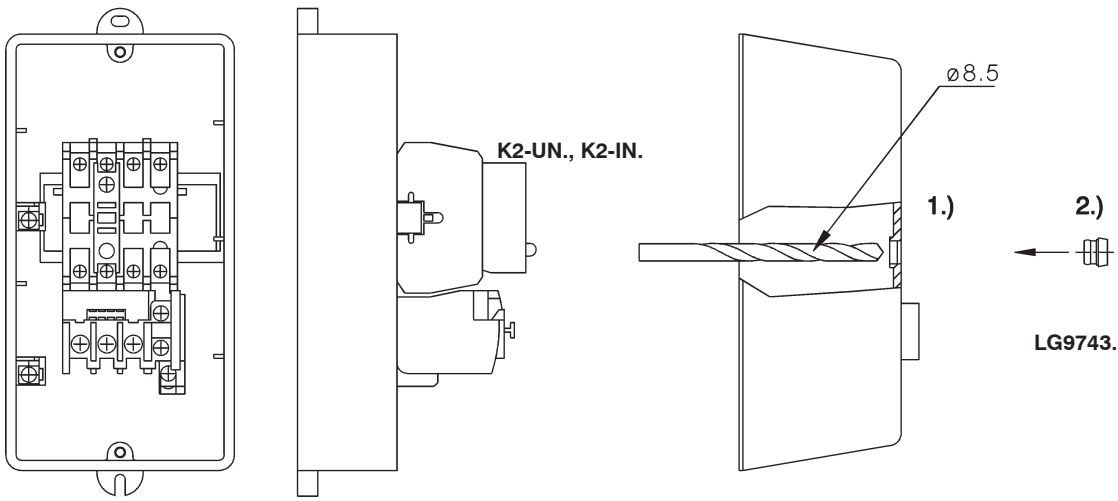

### Wiring Examples

#### Coil Current Indicator

K2-ING  
K2-INR

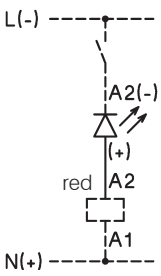

#### Voltage Indicator

K2-UN  
K2-UNR

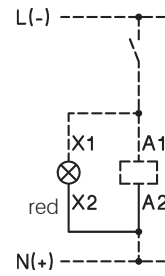

#### Heating Element

K2-HR

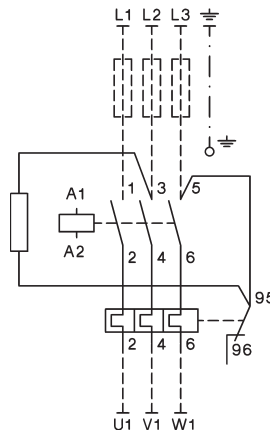

K2-HR 230

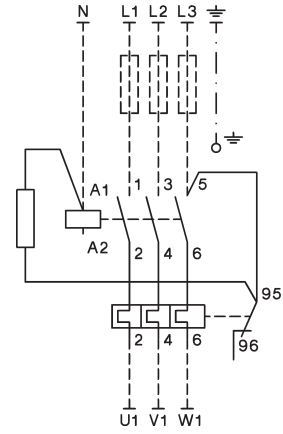

Colour mentioned in wiring diagrams refer to the outgoing connection wire of the device.

Start Contact LG9319-K3 for K3-10ND10 up to K3-22ND10

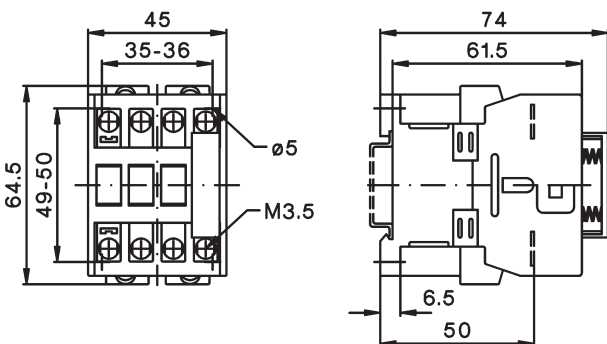



Thermal Overload Relays for Direct Mounting

120

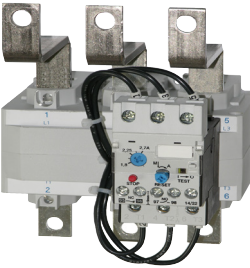

Thermal Overload Relays for Separate Mounting

122



Accessories

123



Technical Data

125

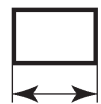

Dimensions

129

# Thermal Overload Relays for plug-in mounting

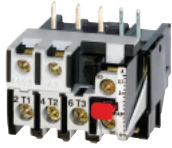

**Setting Range**  
D.O.L. (A)  $\Upsilon\Delta$  (A)

**Type**

Pack Weight  
pcs. kg/pc.

Wiring Diagram

## With Manual Reset, for contactors K1-..

|                    |             |  |                        |   |      |
|--------------------|-------------|--|------------------------|---|------|
| 0,12 - <b>0,18</b> | -           |  | <b>U12/16E 0,18 K1</b> | 1 | 0,10 |
| 0,18 - <b>0,27</b> | -           |  | <b>U12/16E 0,27 K1</b> | 1 | 0,10 |
| 0,27 - <b>0,4</b>  | -           |  | <b>U12/16E 0,4 K1</b>  | 1 | 0,10 |
| 0,4 - <b>0,6</b>   | -           |  | <b>U12/16E 0,6 K1</b>  | 1 | 0,10 |
| 0,6 - <b>0,9</b>   | -           |  | <b>U12/16E 0,9 K1</b>  | 1 | 0,10 |
| 0,8 - <b>1,2</b>   | -           |  | <b>U12/16E 1,2 K1</b>  | 1 | 0,10 |
| 1,2 - <b>1,8</b>   | -           |  | <b>U12/16E 1,8 K1</b>  | 1 | 0,10 |
| 1,8 - <b>2,7</b>   | -           |  | <b>U12/16E 2,7 K1</b>  | 1 | 0,10 |
| 2,7 - <b>4</b>     | -           |  | <b>U12/16E 4 K1</b>    | 1 | 0,10 |
| 4 - <b>6</b>       | 7 - 10,5    |  | <b>U12/16E 6 K1</b>    | 1 | 0,10 |
| 6 - <b>9</b>       | 10,5 - 15,5 |  | <b>U12/16E 9 K1</b>    | 1 | 0,10 |
| 8 - <b>11</b>      | 14 - 19     |  | <b>U12/16E 11 K1</b>   | 1 | 0,10 |
| 10 - <b>14</b>     | 18 - 24     |  | <b>U12/16E 14 K1</b>   | 1 | 0,10 |

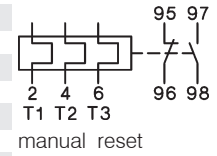

## With Auto Reset, for contactors K1-..

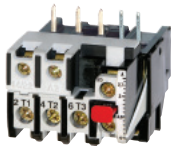

|                    |             |  |                        |   |      |
|--------------------|-------------|--|------------------------|---|------|
| 0,12 - <b>0,18</b> | -           |  | <b>U12/16A 0,18 K1</b> | 1 | 0,10 |
| 0,18 - <b>0,27</b> | -           |  | <b>U12/16A 0,27 K1</b> | 1 | 0,10 |
| 0,27 - <b>0,4</b>  | -           |  | <b>U12/16A 0,4 K1</b>  | 1 | 0,10 |
| 0,4 - <b>0,6</b>   | -           |  | <b>U12/16A 0,6 K1</b>  | 1 | 0,10 |
| 0,6 - <b>0,9</b>   | -           |  | <b>U12/16A 0,9 K1</b>  | 1 | 0,10 |
| 0,8 - <b>1,2</b>   | -           |  | <b>U12/16A 1,2 K1</b>  | 1 | 0,10 |
| 1,2 - <b>1,8</b>   | -           |  | <b>U12/16A 1,8 K1</b>  | 1 | 0,10 |
| 1,8 - <b>2,7</b>   | -           |  | <b>U12/16A 2,7 K1</b>  | 1 | 0,10 |
| 2,7 - <b>4</b>     | -           |  | <b>U12/16A 4 K1</b>    | 1 | 0,10 |
| 4 - <b>6</b>       | 7 - 10,5    |  | <b>U12/16A 6 K1</b>    | 1 | 0,10 |
| 6 - <b>9</b>       | 10,5 - 15,5 |  | <b>U12/16A 9 K1</b>    | 1 | 0,10 |
| 8 - <b>11</b>      | 14 - 19     |  | <b>U12/16A 11 K1</b>   | 1 | 0,10 |
| 10 - <b>14</b>     | 18 - 24     |  | <b>U12/16A 14 K1</b>   | 1 | 0,10 |

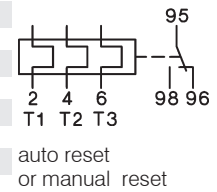

## With Quick Tripping Characteristic for EEx e motors and submersible pumps, f. contactors K1-..

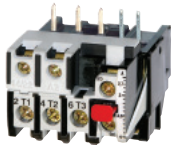

|                  |             |  |                        |   |      |
|------------------|-------------|--|------------------------|---|------|
| 0,4 - <b>0,6</b> | -           |  | <b>U12/16EQ 0,6 K1</b> | 1 | 0,10 |
| 0,6 - <b>0,9</b> | -           |  | <b>U12/16EQ 0,9 K1</b> | 1 | 0,10 |
| 0,8 - <b>1,2</b> | -           |  | <b>U12/16EQ 1,2 K1</b> | 1 | 0,10 |
| 1,2 - <b>1,8</b> | -           |  | <b>U12/16EQ 1,8 K1</b> | 1 | 0,10 |
| 1,8 - <b>2,7</b> | -           |  | <b>U12/16EQ 2,7 K1</b> | 1 | 0,10 |
| 2,7 - <b>4</b>   | -           |  | <b>U12/16EQ 4 K1</b>   | 1 | 0,10 |
| 4 - <b>6</b>     | 7 - 10,5    |  | <b>U12/16EQ 6 K1</b>   | 1 | 0,10 |
| 6 - <b>9</b>     | 10,5 - 15,5 |  | <b>U12/16EQ 9 K1</b>   | 1 | 0,10 |
| 8 - <b>11</b>    | 14 - 19     |  | <b>U12/16EQ 11 K1</b>  | 1 | 0,10 |

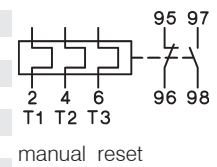

# Thermal Overload Relays for plug-in mounting

Contactors, Motor-Starters  
 Circuit Breakers  
 Manual Motor-Starters  
 Switches  
 AC-Main Switches  
 DC-Switch Disconnectors  
 Push Buttons  
 Representatives, Suppliers

**Setting Range**  
**D.O.L. (A)**      **YΔ (A)**      **Type**      Pack pcs.      Weight kg/pc.      Wiring Diagram

**With Manual Reset**, for contactors K(G)3-10.. to K(G)3-22.. ..

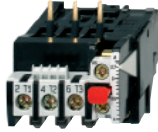

|                    |             |  |                        |   |      |
|--------------------|-------------|--|------------------------|---|------|
| 0,12 - <b>0,18</b> | -           |  | <b>U12/16E 0,18 K3</b> | 1 | 0,10 |
| 0,18 - <b>0,27</b> | -           |  | <b>U12/16E 0,27 K3</b> | 1 | 0,10 |
| 0,27 - <b>0,4</b>  | -           |  | <b>U12/16E 0,4 K3</b>  | 1 | 0,10 |
| 0,4 - <b>0,6</b>   | -           |  | <b>U12/16E 0,6 K3</b>  | 1 | 0,10 |
| 0,6 - <b>0,9</b>   | -           |  | <b>U12/16E 0,9 K3</b>  | 1 | 0,10 |
| 0,8 - <b>1,2</b>   | -           |  | <b>U12/16E 1,2 K3</b>  | 1 | 0,10 |
| 1,2 - <b>1,8</b>   | -           |  | <b>U12/16E 1,8 K3</b>  | 1 | 0,10 |
| 1,8 - <b>2,7</b>   | -           |  | <b>U12/16E 2,7 K3</b>  | 1 | 0,10 |
| 2,7 - <b>4</b>     | -           |  | <b>U12/16E 4 K3</b>    | 1 | 0,10 |
| 4 - <b>6</b>       | 7 - 10,5    |  | <b>U12/16E 6 K3</b>    | 1 | 0,10 |
| 6 - <b>9</b>       | 10,5 - 15,5 |  | <b>U12/16E 9 K3</b>    | 1 | 0,10 |
| 8 - <b>11</b>      | 14 - 19     |  | <b>U12/16E 11 K3</b>   | 1 | 0,10 |
| 10 - <b>14</b>     | 18 - 24     |  | <b>U12/16E 14 K3</b>   | 1 | 0,10 |
| 13 - <b>18</b>     | 23 - 31     |  | <b>U12/16E 18 K3</b>   | 1 | 0,10 |
| 17 - <b>23</b>     | 30 - 40     |  | <b>U12/16E 23 K3</b>   | 1 | 0,10 |
| 22 - <b>30</b>     | 38 - 52     |  | <b>U12/16E 30 K3</b>   | 1 | 0,13 |

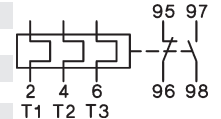

manual reset

**With quick Tripping Characteristic** for EEx e motors and under water pumps

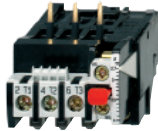

|                  |             |  |                        |   |      |
|------------------|-------------|--|------------------------|---|------|
| 0,4 - <b>0,6</b> | -           |  | <b>U12/16EQ 0,6 K3</b> | 1 | 0,10 |
| 0,6 - <b>0,9</b> | -           |  | <b>U12/16EQ 0,9 K3</b> | 1 | 0,10 |
| 0,8 - <b>1,2</b> | -           |  | <b>U12/16EQ 1,2 K3</b> | 1 | 0,10 |
| 1,2 - <b>1,8</b> | -           |  | <b>U12/16EQ 1,8 K3</b> | 1 | 0,10 |
| 1,8 - <b>2,7</b> | -           |  | <b>U12/16EQ 2,7 K3</b> | 1 | 0,10 |
| 2,7 - <b>4</b>   | -           |  | <b>U12/16EQ 4 K3</b>   | 1 | 0,10 |
| 4 - <b>6</b>     | 7 - 10,5    |  | <b>U12/16EQ 6 K3</b>   | 1 | 0,10 |
| 6 - <b>9</b>     | 10,5 - 15,5 |  | <b>U12/16EQ 9 K3</b>   | 1 | 0,10 |
| 8 - <b>11</b>    | 14 - 19     |  | <b>U12/16EQ 11 K3</b>  | 1 | 0,10 |
| 10 - <b>14</b>   | 18 - 24     |  | <b>U12/16EQ 14 K3</b>  | 1 | 0,10 |

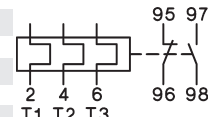

manual reset

For contactors K(G)3-10.. to K(G)3-40A..



|                    |             |  |                   |   |      |
|--------------------|-------------|--|-------------------|---|------|
| 0,12 - <b>0,18</b> | -           |  | <b>U3/32 0,18</b> | 1 | 0,14 |
| 0,18 - <b>0,27</b> | -           |  | <b>U3/32 0,27</b> | 1 | 0,14 |
| 0,27 - <b>0,4</b>  | -           |  | <b>U3/32 0,4</b>  | 1 | 0,14 |
| 0,4 - <b>0,6</b>   | -           |  | <b>U3/32 0,6</b>  | 1 | 0,14 |
| 0,6 - <b>0,9</b>   | -           |  | <b>U3/32 0,9</b>  | 1 | 0,14 |
| 0,8 - <b>1,2</b>   | -           |  | <b>U3/32 1,2</b>  | 1 | 0,14 |
| 1,2 - <b>1,8</b>   | -           |  | <b>U3/32 1,8</b>  | 1 | 0,14 |
| 1,8 - <b>2,7</b>   | -           |  | <b>U3/32 2,7</b>  | 1 | 0,14 |
| 2,7 - <b>4</b>     | -           |  | <b>U3/32 4</b>    | 1 | 0,14 |
| 4 - <b>6</b>       | 7 - 10,5    |  | <b>U3/32 6</b>    | 1 | 0,14 |
| 6 - <b>9</b>       | 10,5 - 15,5 |  | <b>U3/32 9</b>    | 1 | 0,14 |
| 8 - <b>11</b>      | 14 - 19     |  | <b>U3/32 11</b>   | 1 | 0,14 |
| 10 - <b>14</b>     | 18 - 24     |  | <b>U3/32 14</b>   | 1 | 0,14 |
| 13 - <b>18</b>     | 23 - 31     |  | <b>U3/32 18</b>   | 1 | 0,14 |
| 17 - <b>24</b>     | 30 - 41     |  | <b>U3/32 24</b>   | 1 | 0,14 |
| 23 - <b>32</b>     | 40 - 55     |  | <b>U3/32 32</b>   | 1 | 0,14 |

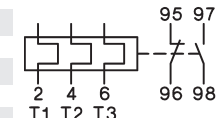

manual and auto reset

For contactors K(G)3-24A.. to K(G)3-40A ..



|                |         |  |                 |   |      |
|----------------|---------|--|-----------------|---|------|
| 10 - <b>14</b> | 18 - 24 |  | <b>U3/42 14</b> | 1 | 0,30 |
| 14 - <b>20</b> | 24 - 35 |  | <b>U3/42 20</b> | 1 | 0,30 |
| 20 - <b>28</b> | 35 - 48 |  | <b>U3/42 28</b> | 1 | 0,30 |
| 28 - <b>42</b> | 48 - 73 |  | <b>U3/42 42</b> | 1 | 0,30 |

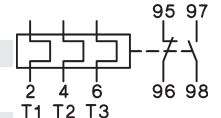

manual and auto reset



## Thermal Overload Relays for plug-in mounting



| Setting Range<br>D.O.L. (A)         |           | $\Delta$ (A) | Type            | Pack pcs. | Weight kg/pc. |
|-------------------------------------|-----------|--------------|-----------------|-----------|---------------|
| For contactors K3-50A.. to K3-74A.. |           |              |                 |           |               |
| 20 - <b>28</b>                      | 35 - 48   |              | <b>U3/74 28</b> | 1         | 0,40          |
| 28 - <b>42</b>                      | 48 - 73   |              | <b>U3/74 42</b> | 1         | 0,40          |
| 40 - <b>52</b>                      | 70 - 90   |              | <b>U3/74 52</b> | 1         | 0,40          |
| 52 - <b>65</b>                      | 90 - 112  |              | <b>U3/74 65</b> | 1         | 0,40          |
| 60 - <b>74</b>                      | 104 - 128 |              | <b>U3/74 74</b> | 1         | 0,40          |

Wiring Diagram

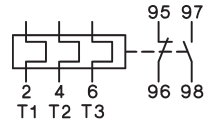

manual and auto reset

## Thermal Overload Relays for separate mounting

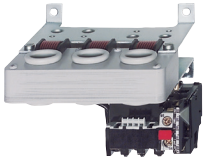

| Setting Range<br>D.O.L. (A)             |           | $\Delta$ (A) | Type           | Pack pcs. | Weight kg/pc. |
|---|-----------|--------------|----------------|-----------|---------------|
| For contactors K3-90, K3-115, K85, K110 |           |              |                |           |               |
| 60 - <b>90</b>                          | 104 - 156 |              | <b>U85 90</b>  | 1         | 0,90          |
| 80 - <b>120</b>                         | 140 - 207 |              | <b>U85 120</b> |           |               |

Wiring Diagram

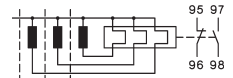

manual reset

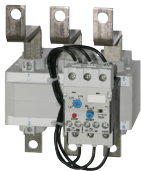

| Setting Range<br>D.O.L. (A)                            |           | $\Delta$ (A) | Type            | Pack pcs. | Weight kg/pc. |
|--|-----------|--------------|-----------------|-----------|---------------|
| For contactors K3-151.. and K3-176.., busbars included |           |              |                 |           |               |
| 120 - <b>180</b>                                       | 208 - 312 |              | <b>U180 180</b> | 1         | 1,5           |

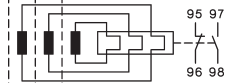

manual and auto reset



| Setting Range<br>D.O.L. (A)                              |           | $\Delta$ (A) | Type            | Pack pcs. | Weight kg/pc. |
|--|-----------|--------------|-----------------|-----------|---------------|
| For contactors K3-210.. up to K3-316.., busbars included |           |              |                 |           |               |
| 144 - <b>216</b>   | 250 - 374 |              | <b>U320 216</b> | 1         | 1,8           |
| 216 - <b>320</b>   | 374 - 554 |              | <b>U320 320</b> |           |               |



manual and auto reset

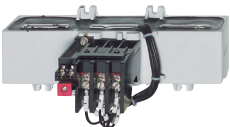

| Setting Range<br>D.O.L. (A)                                     |            | $\Delta$ (A) | Type            | Pack pcs. | Weight kg/pc. |
|---|------------|--------------|-----------------|-----------|---------------|
| For contactors K3-315.., K3-450.., K3-550.., K3-700.., K3-860.. |            |              |                 |           |               |
| 240 - <b>360</b>  | 416 - 623  |              | <b>U800 360</b> | 1         | 4,1           |
| 360 - <b>540</b>  | 623 - 935  |              | <b>U800 540</b> | 1         | 4,1           |
| 540 - <b>800</b>  | 935 - 1385 |              | <b>U800 800</b> | 1         | 4,1           |

### With Slow Tripping Characteristic for heavy duty starting with long run up times

For separate mounting, suitable for all contactors

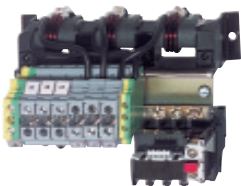

|                  |             |  |                  |   |     |
|------------------|-------------|--|------------------|---|-----|
| 0,8 - <b>1,2</b> | 1,2 - 2,1   |  | <b>UAT21 1,2</b> | 1 | 1,0 |
| 1,2 - <b>1,8</b> | 2,1 - 3,1   |  | <b>UAT21 1,8</b> | 1 | 1,0 |
| 1,6 - <b>2,4</b> | 2,8 - 4,2   |  | <b>UAT21 2,4</b> | 1 | 1,0 |
| 2,4 - <b>3,7</b> | 4,2 - 6,4   |  | <b>UAT21 3,7</b> | 1 | 1,0 |
| 3,7 - <b>5,7</b> | 6,4 - 9,9   |  | <b>UAT21 5,7</b> | 1 | 1,0 |
| 5,3 - <b>8,2</b> | 9,2 - 14,2  |  | <b>UAT21 8,2</b> | 1 | 1,0 |
| 8 - <b>12</b>    | 13,9 - 20,1 |  | <b>UAT21 12</b>  | 1 | 1,0 |
| 12 - <b>18</b>   | 20,1 - 31,2 |  | <b>UAT21 18</b>  | 1 | 1,0 |
| 16 - <b>24</b>   | 27,7 - 41,6 |  | <b>UAT22 24</b>  | 1 | 1,1 |
| 24 - <b>37</b>   | 41,6 - 64   |  | <b>UAT23 37</b>  | 1 | 1,3 |
| 32 - <b>49</b>   | 55,4 - 85   |  | <b>UAT23 49</b>  | 1 | 1,3 |
| 48 - <b>72</b>   | 83 - 125    |  | <b>UAT23 72</b>  | 1 | 1,3 |

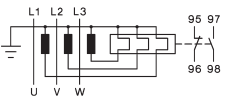

manual reset

## Accessories



for overload relays      for contactors

### Busbar Sets

|      |                    | Type             | Pack set | Weight kg/set |
|------|--------------------|------------------|----------|---------------|
| U800 | K3-450.., K3-550.. | <b>SU840/550</b> | 1        | 1,7           |
| U800 | K3-700.., K3-860.. | <b>SU840/860</b> | 1        | 2,1           |



Cable Cross-section (mm<sup>2</sup>)      Type

overload relay      solid or stranded      flexible

Pack pcs.      Weight kg/pc.

### for Single Mounting U12/16..K3 Base for DIN-rail mounting plus terminals

|            |          |          |                 |   |       |
|------------|----------|----------|-----------------|---|-------|
| U12/16..K3 | 0,75 - 6 | 0,75 - 4 | <b>U12SM K3</b> | 1 | 0,035 |
|------------|----------|----------|-----------------|---|-------|



### for Single Mounting U3/32 Additional Terminals with fingertouch protection (U3/32 relays have base for DIN rail mounting integrated)

|       |          |          |                |   |       |
|-------|----------|----------|----------------|---|-------|
| U3/32 | 0,75 - 6 | 0,75 - 4 | <b>U3/32SM</b> | 1 | 0,035 |
|-------|----------|----------|----------------|---|-------|



### for Single Mounting U3/42 or U3/74 Base for DIN-rail mounting

|              |   |   |               |   |       |
|--------------|---|---|---------------|---|-------|
| U3/42, U3/74 | - | - | <b>U3/42G</b> | 1 | 0,030 |
|--------------|---|---|---------------|---|-------|



### for Single Mounting U3/42 or U3/74 Connecting Wire Set (3 pcs.)

|              |              |                   |                 |   |       |
|--------------|--------------|-------------------|-----------------|---|-------|
| U3/42, U3/74 | 150mm length | 10mm <sup>2</sup> | <b>LG5830-4</b> | 1 | 0,060 |
| U3/42, U3/74 | 250mm length | 10mm <sup>2</sup> | <b>LG5830-2</b> | 1 | 0,100 |



### Additional Terminals with fingertouch protection

|                         |           |          |               |   |       |
|-------------------------|-----------|----------|---------------|---|-------|
| 1-pole f. U12/16, U3/32 | 0,75 - 10 | 0,75 - 6 | <b>LG9339</b> | 1 | 0,009 |
| 3-pole for U3/42        | 4 - 35    | 6 - 25   | <b>LG7559</b> | 1 | 0,052 |



# Thermal Overload Relays, tripping times for selection to motors of protection degree EEx e

## Relays With Standard Tripping Characteristic

**Setting Range** Tripping time depending on the multiple of the current setting from cold condition (tolerance  $\pm 20\%$  of the tripping time)

| A               | A           | $I_A/I_N$<br>3 | $I_A/I_N$<br>4 | $I_A/I_N$<br>5 | $I_A/I_N$<br>6 | $I_A/I_N$<br>7,2 | $I_A/I_N$<br>8 |
|-----------------|-------------|----------------|----------------|----------------|----------------|------------------|----------------|
| <b>U3/32 ..</b> |             |                |                |                |                |                  |                |
| 0,12 -          | <b>0,18</b> | 16,1           | 9,6            | 6,8            | 5,3            | 4,2              | 3,7            |
| 0,18 -          | <b>0,27</b> | 16,6           | 9,7            | 6,7            | 5,2            | 4,1              | 3,6            |
| 0,27 -          | <b>0,4</b>  | 19,4           | 11,4           | 7,9            | 6,1            | 4,7              | 4,2            |
| 0,4 -           | <b>0,6</b>  | 18,7           | 10,9           | 7,6            | 5,9            | 4,6              | 4,0            |
| <b>U3/42</b>    |             |                |                |                |                |                  |                |
| 0,6 -           | <b>0,9</b>  | 19,2           | 11,2           | 7,7            | 5,9            | 4,6              | 4,1            |
| 0,8 -           | <b>1,2</b>  | 20,8           | 12,3           | 8,5            | 6,6            | 5,2              | 4,6            |
| 1,2 -           | <b>1,8</b>  | 25,5           | 14,1           | 9,8            | 7,6            | 5,9              | 5,2            |
| 1,8 -           | <b>2,7</b>  | 26,6           | 15,6           | 10,9           | 8,3            | 6,5              | 5,7            |
| <b>U3/74</b>    |             |                |                |                |                |                  |                |
| 2,7 -           | <b>4</b>    | 22,7           | 13,6           | 9,5            | 7,4            | 5,8              | 5,1            |
| 4 -             | <b>6</b>    | 22,2           | 13,3           | 9,3            | 7,1            | 5,6              | 4,9            |
| 6 -             | <b>9</b>    | 20,4           | 11,9           | 8,2            | 6,1            | 4,7              | 4,0            |
| 8 -             | <b>11</b>   | 20,9           | 11,8           | 7,9            | 5,7            | 4,3              | 3,5            |
| <b>U85 ..</b>   |             |                |                |                |                |                  |                |
| 10 -            | <b>14</b>   | 21,3           | 11,7           | 7,4            | 5,1            | 3,7              | 3,0            |
| 13 -            | <b>18</b>   | 21,2           | 12,1           | 8,0            | 6,2            | 4,6              | 4,1            |
| 17 -            | <b>24</b>   | 20,4           | 12,0           | 8,6            | 6,3            | 4,5              | 3,7            |
| 23 -            | <b>32</b>   | 20,2           | 10,2           | 6,7            | 4,7            | 3,4              | 2,8            |

| A            | A         | $I_A/I_N$<br>3 | $I_A/I_N$<br>4 | $I_A/I_N$<br>5 | $I_A/I_N$<br>6 | $I_A/I_N$<br>7,2 | $I_A/I_N$<br>8 |
|--------------|-----------|----------------|----------------|----------------|----------------|------------------|----------------|
| <b>U3/42</b> |           |                |                |                |                |                  |                |
| 10 -         | <b>14</b> | 21,8           | 11,4           | 7,0            | 5,0            | 3,7              | 2,8            |
| 14 -         | <b>20</b> | 22,4           | 11,2           | 6,7            | 4,5            | 3,2              | 2,4            |
| 20 -         | <b>28</b> | 21,8           | 10,8           | 6,5            | 4,5            | 3,3              | 2,5            |
| 28 -         | <b>42</b> | 25,2           | 13,3           | 8,0            | 5,5            | 4,0              | 3,1            |

| A            | A         | $I_A/I_N$<br>3 | $I_A/I_N$<br>4 | $I_A/I_N$<br>5 | $I_A/I_N$<br>6 | $I_A/I_N$<br>7,2 | $I_A/I_N$<br>8 |
|--------------|-----------|----------------|----------------|----------------|----------------|------------------|----------------|
| <b>U3/74</b> |           |                |                |                |                |                  |                |
| 20 -         | <b>28</b> | 21,8           | 10,8           | 6,5            | 4,5            | 3,3              | 2,5            |
| 28 -         | <b>42</b> | 25,2           | 13,3           | 8,0            | 5,5            | 4,0              | 3,1            |
| 40 -         | <b>52</b> | 18,3           | 9,2            | 5,6            | 3,9            | 2,8              | 2,2            |
| 52 -         | <b>65</b> | 17,8           | 8,7            | 5,2            | 3,4            | 2,5              | 1,9            |

| A             | A          | $I_A/I_N$<br>3 | $I_A/I_N$<br>4 | $I_A/I_N$<br>5 | $I_A/I_N$<br>6 | $I_A/I_N$<br>7,2 | $I_A/I_N$<br>8 |
|---------------|------------|----------------|----------------|----------------|----------------|------------------|----------------|
| <b>U85 ..</b> |            |                |                |                |                |                  |                |
| 60 -          | <b>90</b>  | 19,5           | 13,5           | 11,0           | 10,0           | 9,5              | 8,5            |
| 80 -          | <b>120</b> | 18,0           | 11,0           | 10,0           | 9,0            | 8,5              | 8,0            |

| A              | A          | $I_A/I_N$<br>3 | $I_A/I_N$<br>4 | $I_A/I_N$<br>5 | $I_A/I_N$<br>6 | $I_A/I_N$<br>7,2 | $I_A/I_N$<br>8 |
|----------------|------------|----------------|----------------|----------------|----------------|------------------|----------------|
| <b>U840 ..</b> |            |                |                |                |                |                  |                |
| 260 -          | <b>360</b> | 23,3           | 14,1           | 10,0           | 7,6            | 6,1              | 5,4            |
| 340 -          | <b>480</b> | 23,0           | 13,8           | 9,6            | 7,6            | 6,1              | 5,4            |
| 440 -          | <b>620</b> | 20,5           | 12,4           | 9,0            | 7,0            | 5,5              | 5,0            |
| 560 -          | <b>800</b> | 21,0           | 12,5           | 9,0            | 7,0            | 5,6              | 5,2            |

| A                     | A           | $I_A/I_N$<br>3 | $I_A/I_N$<br>4 | $I_A/I_N$<br>5 | $I_A/I_N$<br>6 | $I_A/I_N$<br>7,2 | $I_A/I_N$<br>8 |
|-----------------------|-------------|----------------|----------------|----------------|----------------|------------------|----------------|
| <b>U12/16E(A) ..</b>  |             |                |                |                |                |                  |                |
| 0,12 -                | <b>0,18</b> | 18,5           | 10,4           | 7,2            | 5,5            | 4,3              | 3,6            |
| 0,18 -                | <b>0,27</b> | 16,7           | 9,8            | 6,5            | 5,0            | 4,1              | 3,5            |
| 0,27 -                | <b>0,4</b>  | 19,4           | 12,1           | 8,2            | 5,9            | 4,9              | 4,2            |
| 0,4 -                 | <b>0,6</b>  | 18,7           | 11,2           | 8,0            | 6,0            | 4,9              | 4,1            |
| <b>U12/16EQ ..</b>    |             |                |                |                |                |                  |                |
| 0,6 -                 | <b>0,9</b>  | 19,7           | 11,6           | 8,1            | 6,1            | 4,9              | 4,2            |
| 0,8 -                 | <b>1,2</b>  | 22,9           | 13,6           | 10,0           | 7,3            | 6,0              | 5,2            |
| 1,2 -                 | <b>1,8</b>  | 22,2           | 13,2           | 9,2            | 7,6            | 5,8              | 5,3            |
| 1,8 -                 | <b>2,7</b>  | 23,0           | 13,7           | 9,3            | 7,6            | 5,7              | 5,1            |
| <b>U12/16E(A) ..</b>  |             |                |                |                |                |                  |                |
| 2,7 -                 | <b>4</b>    | 24,0           | 14,4           | 9,9            | 7,8            | 5,9              | 5,1            |
| 4 -                   | <b>6</b>    | 24,7           | 13,8           | 9,9            | 7,3            | 5,6              | 4,8            |
| 6 -                   | <b>9</b>    | 22,0           | 13,4           | 8              | 5,7            | 4,1              | 3,5            |
| 8 -                   | <b>11</b>   | 17,4           | 9,2            | 5,9            | 4,1            | 2,9              | 2,3            |
| <b>U12/16EQ(A) ..</b> |             |                |                |                |                |                  |                |
| 10 -                  | <b>14</b>   | 26,4           | 12,9           | 7,6            | 5,2            | 3,5              | 2,8            |
| 13 -                  | <b>18</b>   | 14,7           | 7,7            | 4,8            | 3,2            | 2,3              | 1,7            |
| 17 -                  | <b>23</b>   | 16,2           | 8,4            | 5,0            | 3,6            | 2,4              | 1,8            |
| 22 -                  | <b>30</b>   | 16,8           | 8,5            | 5,0            | 3,6            | 2,3              | 1,9            |

## Relays With Quick Tripping Characteristic

preferably for motors with short  $t_E$  time and for submersible pumps

**Setting Range** Tripping time depending on the multiple of the current setting from cold condition (tolerance  $\pm 20\%$  of the tripping time)

| A                  | A          | $I_A/I_N$<br>3 | $I_A/I_N$<br>4 | $I_A/I_N$<br>5 | $I_A/I_N$<br>6 | $I_A/I_N$<br>7,2 | $I_A/I_N$<br>8 |
|--------------------|------------|----------------|----------------|----------------|----------------|------------------|----------------|
| <b>U12/16EQ ..</b> |            |                |                |                |                |                  |                |
| 0,4 -              | <b>0,6</b> | 13,6           | 8,4            | 5,9            | 4,2            | 3,3              | 3,0            |
| 0,6 -              | <b>0,9</b> | 13,8           | 7,8            | 5,2            | 4,1            | 3,2              | 2,7            |
| 0,8 -              | <b>1,2</b> | 13,1           | 7,5            | 5,2            | 3,9            | 3,1              | 2,7            |
| 1,2 -              | <b>1,8</b> | 14,6           | 8,7            | 6,0            | 4,6            | 3,6              | 3,2            |
| <b>U12/16EQ ..</b> |            |                |                |                |                |                  |                |
| 1,8 -              | <b>2,7</b> | 13,5           | 7,6            | 5,3            | 3,9            | 3,1              | 2,7            |
| 2,7 -              | <b>4</b>   | 11,0           | 6,0            | 4,1            | 2,6            | 1,7              | 1,4            |
| 4 -                | <b>6</b>   | 9,6            | 5,3            | 3,3            | 2,3            | 1,6              | 1,3            |
| 6 -                | <b>9</b>   | 10,2           | 5,4            | 3,4            | 2,3            | 1,6              | 1,3            |
| <b>U12/16EQ ..</b> |            |                |                |                |                |                  |                |
| 8 -                | <b>11</b>  | 12,0           | 6,2            | 3,9            | 2,5            | 1,8              | 1,3            |
| 10 -               | <b>14</b>  | 12,8           | 6,6            | 4,0            | 2,6            | 1,8              | 1,4            |

All tripping times of overload relays U12/16EQ are shorter than the minimum values of the  $t_E$  time for motors of protection degree EEx e acc. to EN 50019 and therefore are suitable for all motors of protection degree EEx e. For these overload relays the selection on basis of tripping curves is thereby not necessary.

When selecting a standard overload, refer to the tripping curve. Determine the values of the starting current ratio  $I_A/I_N$  and the time  $t_E$  which is marked on the label of the motor. The overload must trip within the  $t_E$  time, which means that the tripping curve from cold condition must be (20% due to tolerance) below the co-ordination point  $I_A/I_N$  and the time  $t_E$ .  
 $I_A$  = Starting current of motor       $I_N$  = Rated current of motor  
 $t_E$  =  $t_E$ -time of motor

Time  $t_E$ /Tripping time

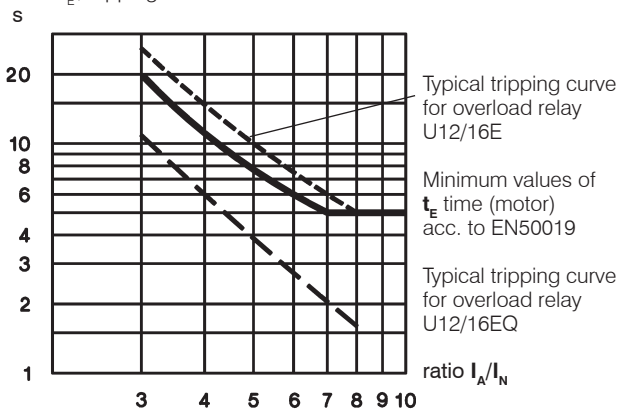

Labels of tripping curves for each setting range, sized 148x105mm (self-adhesive) are available on request.

Order No. D588, specify type and setting range.

### Example of selection for thermal overload relay:

Technical data of a motor protection EEx e  
 $P_N = 1,5kW$     $I_N = 3,6A$     $I_A/I_N = 5$     $t_E$  time = 8s

1) U12/16E 4 (2,7 - 4A)  
 Tripping time at  $5 \times I_N = 9,9s$   
 $9,9s + 20\% \text{ tolerance} = 11,9s > t_{E \text{ Motor}} = 8s$   
 The device U12/16E 4 is **not suitable**.

2) U12/16EQ 4 (2,7 - 4A)  
 Tripping time at  $5 \times I_N = 4,1s$   
 $4,1s + 20\% \text{ tolerance} = 4,9s < t_{E \text{ Motor}} = 8s$   
**The device U12/16EQ 4 is therefore suitable for motor protection**

# Thermal Overload Relays

## Fuses for U3/32, U3/42, U3/74, U12/16E, U85, U180, U320 and U800

| Type                   | Setting Range            |             | Max. Fuse Size According to Coordination-type |                   |                   |      | Fuse UL | SCCR |
|------------------------|--------------------------|-------------|---|-------------------|-------------------|------|---------|------|
|                        | DOL                      | YΔ          | "2" <sup>1)</sup>                             |                   | "1" <sup>1)</sup> |      |         |      |
|                        |                          |             | quick A                                       | slow, gL(gG) A    | slow, gL(gG) A    | aM A |         |      |
| U3/32<br>(U12/16E)     | 0,12 - <b>0,18</b>       | -           | 0,5 <sup>2)</sup>                             | 0,5 <sup>2)</sup> | 25                | -    | 15      | 5    |
|                        | 0,18 - <b>0,27</b>       | -           | 1,0 <sup>2)</sup>                             | 1,0 <sup>2)</sup> | 25                | -    | 15      | 5    |
|                        | 0,27 - <b>0,4</b>        | -           | 2   | 2                 | 25                | -    | 15      | 5    |
|                        | 0,4 - <b>0,6</b>         | -           | 2   | 2                 | 25                | -    | 15      | 5    |
|                        | 0,6 - <b>0,9</b>         | -           | 4   | 4                 | 25                | -    | 15      | 5    |
|                        | 0,8 - <b>1,2</b>         | -           | 4   | 4                 | 25                | 2    | 15      | 5    |
|                        | 1,2 - <b>1,8</b>         | -           | 6   | 6                 | 25                | 2    | 15      | 5    |
|                        | 1,8 - <b>2,7</b>         | -           | 10  | 10                | 25                | 4    | 15      | 5    |
|                        | 2,7 - <b>4</b>           | -           | 16  | 10                | 25                | 4    | 15      | 5    |
|                        | 4 - <b>6</b>             | 7 - 10,5    | 20  | 16                | 25                | 6    | 15      | 5    |
|                        | 6 - <b>9</b>             | 10,5 - 15,5 | 35  | 25                | 35                | 10   | 25      | 5    |
|                        | 8 - <b>11</b>            | 14 - 19     | 35  | 25                | 35                | 16   | 30      | 5    |
|                        | 10 - <b>14</b>           | 18 - 24     | 50  | 35                | 63                | 16   | 40      | 5    |
|                        | 13 - <b>18</b>           | 23 - 31     | 50  | 35                | 63                | 20   | 50      | 5    |
| 17 - <b>(23)24</b>     | 30 - (40)41              | 63          | 50  | 63                | 25                | 60   | 5       |      |
| (22)23 - <b>(30)32</b> | (38)40 - (52)55          | 80          | 63  | 80                | 35                | 70   | 5       |      |
| U3/42                  | 10 - <b>14</b>           | 18 - 24     | 50  | 35                | 80                | 16   | 40      | 5    |
|                        | 14 - <b>20</b>           | 24 - 35     | 63  | 50                | 80                | 25   | 60      | 5    |
|                        | 20 - <b>28</b>           | 35 - 48     | 80  | 63                | 80                | 35   | 80      | 5    |
|                        | 28 - <b>42</b>           | 48 - 73     | 100   | 80                | 150               | 50   | 110     | 5    |
| U3/74                  | 20 - <b>28</b>           | 35 - 48     | 100   | 80                | 150               | 35   | 80      | 5    |
|                        | 28 - <b>42</b>           | 48 - 73     | 125   | 100               | 150               | 50   | 110     | 5    |
|                        | 40 - <b>52</b>           | 70 - 90     | 160   | 100               | 150               | 63   | 200     | 5    |
|                        | 52 - <b>65</b>           | 90 - 112    | 160   | 125               | 150               | 80   | 250     | 10   |
|                        | 60 - <b>74</b>           | 104 - 128   | 160   | 125               | 150               | 80   | 250     | 10   |
| U85                    | 60 - <b>90</b>           | 104 - 156   |   |                   |                   |      | 300     | 10   |
|                        | 80 - <b>120</b>          | 140 - 207   |   |                   |                   |      | -       | 10   |
| U180, U320<br>U800     | all ranges<br>all ranges |             |   |                   |                   |      | -       | -    |

For short circuit protecting overload relays with current transformer use fuse according to the contactor of the combination.

### Tripping Characteristics for U3/32, U3/42, U3/74 and U12/16E

Detailed tripping times for each range see table page 124

#### with three-phase load

Tripping time min. s (Average value of typical tolerance curves from cold condition)

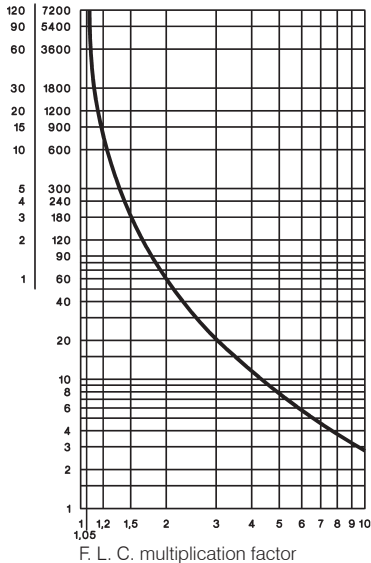

#### with two-pole load

Tripping time min. s (Typical tolerance curve from cold condition)

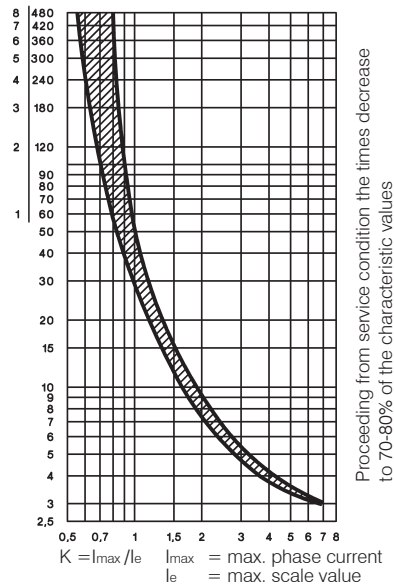

- 1) Coordination-type according to IEC 947-4-1:
- "2": Light contact welding accepted. Thermal overload relay must not be damaged.
- "1": Welding of contactor and damage of the thermal overload relay allowed.
- 2) Miniature fuse

- 3) Suitable for use on a capability of delivering not more than

# Thermal Overload Relays

## Tripping Characteristics for U85, U180, U320, and U800

Detailed tripping times for each range of U85 see table page 124

### U85 with three-phase load

Tripping time (Average value of typical tolerance curves from cold condition)

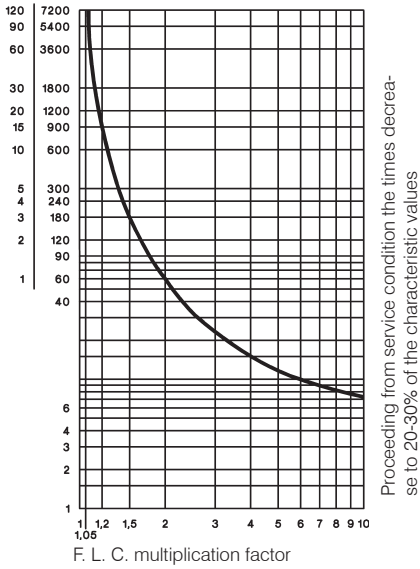

### U180, U320 with three-phase load

Tripping time (Average value of typical tolerance curves from cold condition)

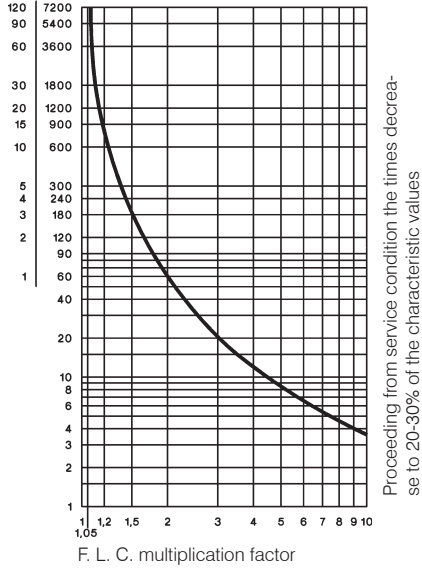

### U800 with three-phase load

Tripping time (Average value of typical tolerance curves from cold condition)

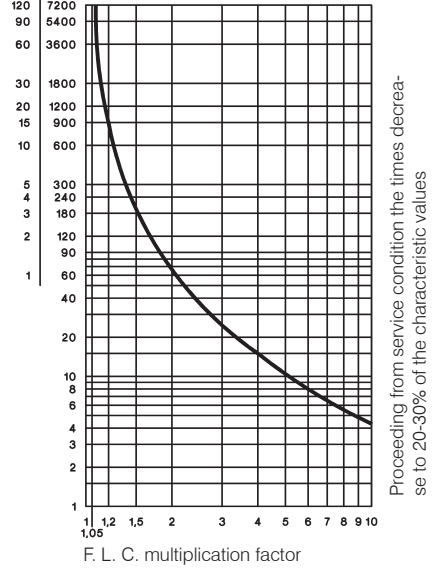

### U85 with two-pole load

Tripping time (Typical tolerance curve from cold condition)

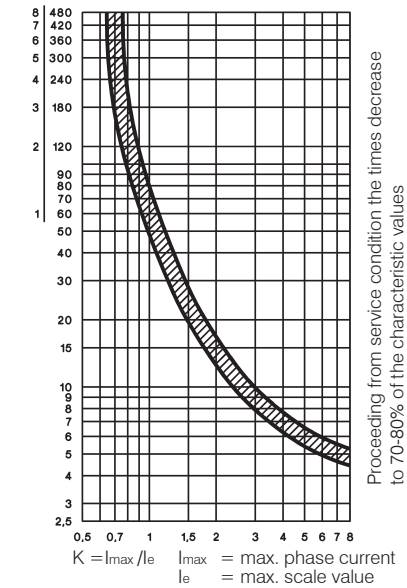

## Position of Terminals

### U3/32

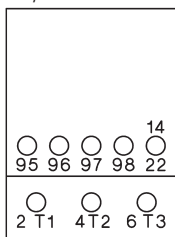

### U12/16E, U12/16EM, U12/16EQ

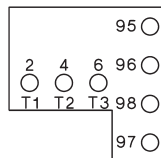

### U12/16A

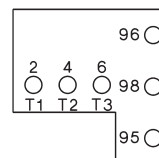

### U3/42, U3/74

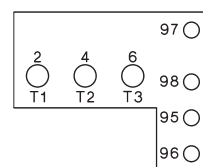

# Thermal Overload Relays in Special Version

## Fuse for U12/16EQ

| Setting Range    | Maximum Fuse Acc. to Coordination-type |                   |  |
|------------------|--|-------------------|--|
|                  | "2" <sup>1)</sup><br>quick<br>A        | slow, gL(gG)<br>A | "1" <sup>1)</sup><br>slow, gL(gG)<br>A |
| 0,4 - <b>0,6</b> | 2                                      | 2                 | 25                                     |
| 0,6 - <b>0,9</b> | 4                                      | 4                 | 25                                     |
| 0,8 - <b>1,2</b> | 4                                      | 4                 | 25                                     |
| 1,2 - <b>1,8</b> | 6                                      | 6                 | 25                                     |
| 1,8 - <b>2,7</b> | 10                                     | 10                | 25                                     |
| 2,7 - <b>4</b>   | 16                                     | 10                | 25                                     |
| 4 - <b>6</b>     | 20                                     | 16                | 25                                     |
| 6 - <b>9</b>     | 35                                     | 25                | 35                                     |
| 8 - <b>11</b>    | 35                                     | 25                | 35                                     |
| 10 - <b>14</b>   | 50                                     | 35                | 63                                     |

## Fuse for U12/16EM

| Setting Range      | Maximum Fuse Acc. to Coordination-type "2" <sup>1)</sup> |                           |                               |
|--------------------|--|---------------------------|-------------------------------|
|                    | 380-400V<br>slow, gL(gG)<br>A                            | 500V<br>slow, gL(gG)<br>A | 660-690V<br>slow, gL(gG)<br>A |
| 0,12 - <b>0,18</b> | none   | none                      | on request                    |
| 0,18 - <b>0,27</b> | none   | none                      | on request                    |
| 0,27 - <b>0,4</b>  | none   | none                      | on request                    |
| 0,4 - <b>0,6</b>   | none   | none                      | on request                    |
| 0,6 - <b>0,9</b>   | none   | none                      | on request                    |
| 0,8 - <b>1,2</b>   | none   | 10                        | on request                    |
| 1,2 - <b>1,8</b>   | none   | 16                        | on request                    |
| 1,8 - <b>2,7</b>   | 20   | 20                        | on request                    |
| 2,7 - <b>4</b>     | 35   | 35                        | on request                    |

## Tripping Characteristic for U12/16EQ

Detailed tripping times for each range see table page 124

### with three-phase load

range 0,4-0,6 to 1,8-2,7A

Tripping time (Typical tolerance curve from cold condition)

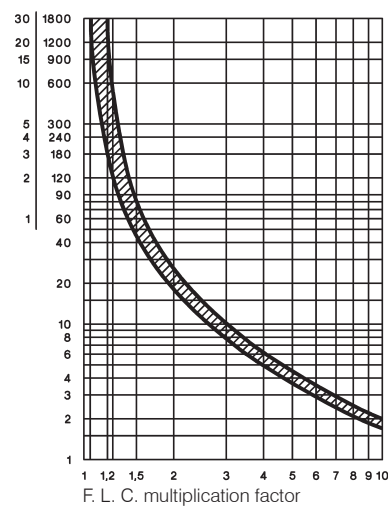

range 2,7-4 to 10-14A

Tripping time (Typical tolerance curve from cold condition)

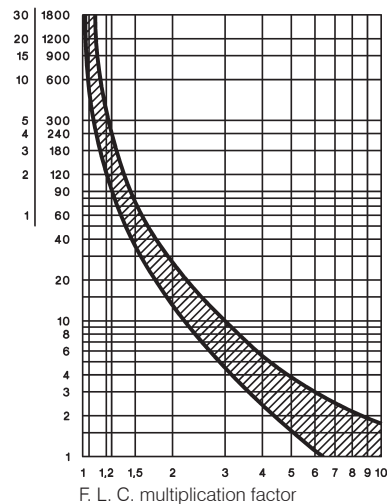

## Tripping Characteristic for U12/16EM

### with three-phase load

Tripping time (Average value of typical tolerance curves from cold condition)

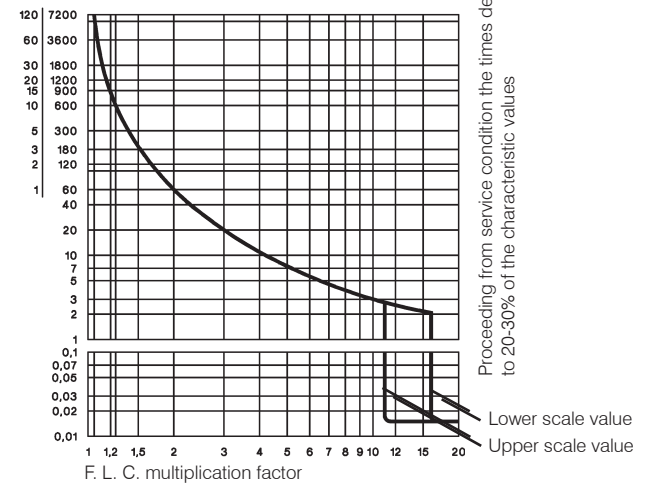

## Fuse for UAT21, UAT22, UAT23

For short circuit protecting thermal overload relays with current transformer use fuse according to the contactor of the combination.

## Tripping characteristic for UAT21, UAT22, UAT23

### with three-phase load

Tripping time in s (Typical tolerance curve from cold condition)

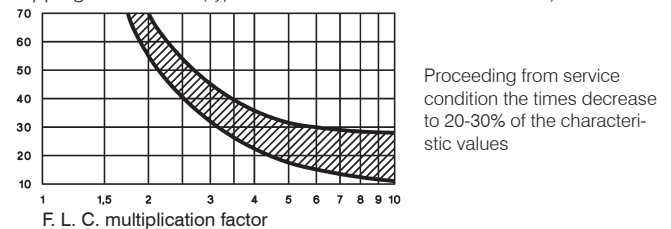

1) Coordination-type according to IEC 947-4-1:  
 "2": Light contact welding accepted. Thermal overload relay must not be damaged.  
 "1": Welding of contactor and damage of the thermal overload relay allowed.

## Thermal Overload Relays

Data according to IEC 947-4-1, IEC 947-5-1, VDE 0660, EN 60947-4-1, EN 60947-5-1

| Type   | U3/32                             | U12/16 <sup>6)</sup> | U3/42      | U3/74                         | U85      | U180               | U320     | U800                | UAT21           | UAT22 | UAT23                  |        |        |
|--|-----------------------------------|----------------------|------------|-------------------------------|----------|--------------------|----------|---------------------|-----------------|-------|------------------------|--------|--------|
| <b>Rated insulation voltage</b> $U_i^{1)}$       | V~                                | 690                  | 690        | 690                           | 690      | 750                | 1000     | 1000                | 690             | 690   | 690                    |        |        |
| <b>Permissible ambient temperature</b>           |                                   |                      |            |                               |          |                    |          |                     |                 |       |                        |        |        |
| operation  | open                              |                      | -25 to +60 |                               |          |                    |          | -25 to +55          | -25 to +60      |       |                        |        |        |
| storage  |                                   |                      | -50 to +70 |                               |          |                    |          | -40 to +70          | -50 to +70      |       |                        |        |        |
| <b>Trip class according to IEC 947-4-1</b>       | 10A                               | 10A                  | 10A        | 10A                           | 20       | 10A                | 10A      | 10                  | 30              | 30    | 30                     |        |        |
| <b>Cable cross-section</b>                       |                                   |                      |            |                               |          |                    |          |                     |                 |       |                        |        |        |
| main connector                                   | solid or stranded                 | mm <sup>2</sup>      | 0,75-6     | 0,75-6+0,75-2,5 <sup>2)</sup> | 0,75-10  | 4-35 <sup>2)</sup> | 3)       | 7)                  | -               | 7)    | 0,5-10                 | 0,5-16 | 0,5-25 |
|  | flexible                          | mm <sup>2</sup>      | 1-4        | 0,75-4+0,5-2,5 <sup>2)</sup>  | 0,75-6   | 6-25 <sup>2)</sup> |          |                     |                 |       | 0,5-6                  | 0,5-10 | 0,5-16 |
|  | flexible with multicore cable end | mm <sup>2</sup>      | 0,75-4     | 0,5-2,5+0,5-1,5               | 0,75-6   | 4-25               |          |                     |                 |       | 0,5-6                  | 0,5-10 | 0,5-16 |
| Cables per clamp                                 | number                            |                      | 2          | 1+1                           | 2        | 1                  |          |                     |                 |       | 1                      | 1      | 1      |
| auxiliary connector                              | solid                             | mm <sup>2</sup>      |            | 0,75-2,5 <sup>2)</sup>        |          |                    |          | 1-2,5 <sup>2)</sup> |                 |       | 0,75-2,5 <sup>2)</sup> |        |        |
|  | flexible                          | mm <sup>2</sup>      |            | 0,5-2,5 <sup>2)</sup>         |          |                    |          | 1-2,5 <sup>2)</sup> |                 |       | 0,5-2,5 <sup>2)</sup>  |        |        |
|  | flexible with multicore cable end | mm <sup>2</sup>      |            | 0,5-1,5                       |          |                    |          | 1-2,5 <sup>2)</sup> |                 |       | 0,5-1,5                |        |        |
| Cables per clamp                                 | number                            |                      |            | 2                             |          |                    |          | 2                   |                 |       | 2                      |        |        |
| Type   | U3/32                             | U12/16A              | U12/16E    | U12/16EQ                      | U3/42    | U85                | U180     | U800                | UAT21           | UAT22 | UAT23                  |        |        |
| <b>Auxiliary contacts</b>                        |                                   |                      |            |                               |          |                    |          |                     |                 |       |                        |        |        |
| <b>Rated insulation voltage</b> $U_i^{1)}$       |                                   |                      |            |                               |          |                    |          |                     |                 |       |                        |        |        |
| same potential                                   | V~                                | 690                  | 690        | 690                           | 690      | 690                | 690      | 500                 | 690             |       |                        |        |        |
| different potential                              | V~                                | 440                  | -          | 440                           | 440      | 250                | 440      | 440                 | 500             | 440   |                        |        |        |
| <b>Utilization category AC15</b>                 |                                   |                      |            |                               |          |                    |          |                     |                 |       |                        |        |        |
| Rated operational current $I_e$                  | 24V A                             | 3                    | 4          | 5                             | 5        | 4                  | 5        | 3                   | 4 <sup>5)</sup> | 5     |                        |        |        |
|  | 230V A                            | 2                    | 2,5        | 3                             | 3        | 2,5                | 3        | 2                   | 2,5             | 3     |                        |        |        |
|  | 400V A                            | 1                    | 1,5        | 2                             | 2        | 1,5                | 2        | 1                   | 1,5             | 2     |                        |        |        |
|  | 690V A                            | 0,5                  | 0,6        | 0,6                           | 0,6      | 0,6                | 0,6      | 0,5                 | 0,6             | 0,6   |                        |        |        |
| <b>Utilization category DC13</b>                 |                                   |                      |            |                               |          |                    |          |                     |                 |       |                        |        |        |
| Rated operational current $I_e$                  | 24V A                             | 1                    | 1,2        | 1,2                           | 1,2      | 1,2                | 1,2      | 1                   | 1,2             | 1,2   |                        |        |        |
|  | 110V A                            | 0,15                 | 0,15       | 0,15                          | 0,15     | 0,15               | 0,15     | 0,15                | 0,15            | 0,15  |                        |        |        |
|  | 220V A                            | 0,1                  | 0,1        | 0,1                           | 0,1      | 0,1                | 0,1      | 0,1                 | 0,1             | 0,1   |                        |        |        |
| <b>Short circuit prot.</b> (without welding 1kA) |                                   |                      |            |                               |          |                    |          |                     |                 |       |                        |        |        |
| highest fuse rating                              | gL (gG) A                         | 4                    | 4          | 6                             | 6        | 6                  | 6        | 4                   | 6               | 6     |                        |        |        |
| Type   | U3/32                             | U12/16               | U12/16E    | U3/42                         | U3/42    | U3/74              | U3/74    | U85                 |                 |       |                        |        |        |
| Setting range                                    | all                               | to 23A               | 22 - 30A   | to 28A                        | 28 - 42A | to 52A             | 52 - 65A | all                 |                 |       |                        |        |        |
| <b>Power loss per current path (max.)</b>        |                                   |                      |            |                               |          |                    |          |                     |                 |       |                        |        |        |
| minimum setting value                            | W                                 | 1,1                  | 1,1        | 1,7                           | 1,3      | 1,3                | 2,0      | 1,1                 |                 |       |                        |        |        |
| maximum setting value                            | W                                 | 2,3                  | 2,3        | 3,7                           | 2,6      | 3,3                | 3,7      | 2,5                 |                 |       |                        |        |        |

## Data according to cULus

| Type                            | U3/32 | U12/16A | U12/16E | U3/42 | U3/74 | U85 |
|---------------------------------|-------|---------|---------|-------|-------|-----|
| <b>Rated insulation voltage</b> | V~    | 600     | 600     | 600   | 600   | 600 |
| <b>Rated current</b>            | A     | 32      | 23      | 23    | 42    | 75  |
| <b>Auxiliary contacts</b>       |       |         |         |       |       |     |
| Rated voltage                   |       |         |         |       |       |     |
| same potential                  | V~    | 600     | 600     | 600   | 600   | 600 |
| different potential             | V~    | 150     | -       | 150   | 150   | 150 |
| <b>Switching capacity AC</b>    | VA    | 500     | 500     | 500   | 600   | 600 |
| of aux. contacts                | A     | 2       | 3       | 4     | 4     | 4   |

## Temperature Compensation

In case of higher ambient temperature use the following formula:  
**(Ambient temperature - 20) x 0,125 = correction factor in % of the full load motor current**

**Example: Ambient temperature 70°C, full load motor current 7A**  
**(70 - 20) x 0,125 = 6,25%**  
**Setting value: 7A + 6,25% = 7,44A**

1) Suitable for: earthed-neutral systems, overvoltage category I to III, pollution degree 3 (standard-industry):  $U_{imp} = 4kV$  (at 440V), 6kV (at 690V).

Data for other conditions on request.

2) Maximum cable cross-section with prepared conductor

3) Without terminals, suitable for bushing one connector 70mm<sup>2</sup> (stranded) per phase

4) Switching capacity of the start contact: AC15 300VA, max. 1,5A, DC13 (max. 220V) 30W, max. 1,5A

5) Switching capacity of the make contact: AC15 400VA, max. 1,7A, DC13 (max. 220V) 10W, max. 1A

6) U12/16E 30: Cable cross-section for main connector like type U3/42, one connector only

7) Busbar sets see accessories page 123

# Thermal Overload Relays

## Dimensions

K3-10N + U3/32

K3-14N

K3-18N

K3-22N

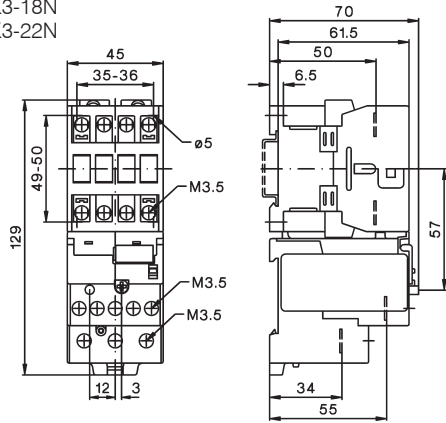

KG3-10 + U3/32

KG3-14

KG3-18

KG3-22

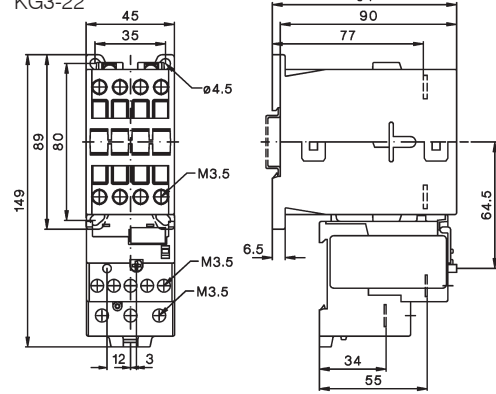

K3-24 + U3/32

K3-32

K3-40

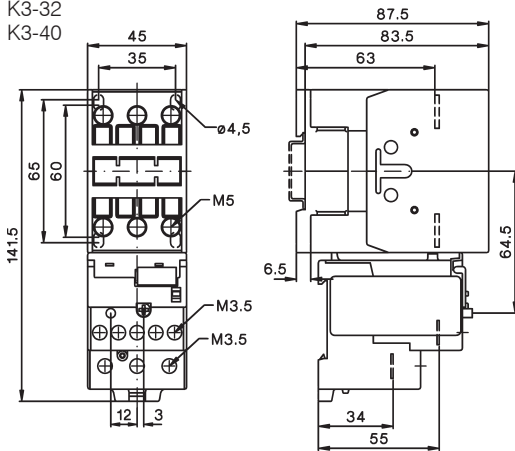

KG3-24 + U3/32

KG3-32

KG3-40

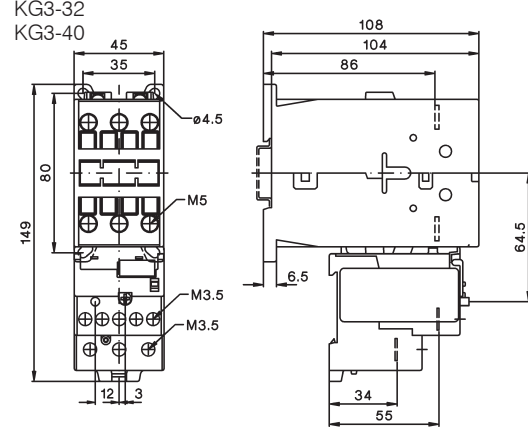

K3-24 + U3/42

K3-32

K3-40

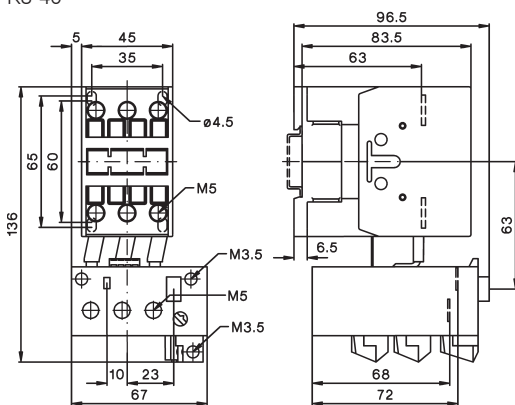

KG3-24 + U3/42

KG3-32

KG3-40

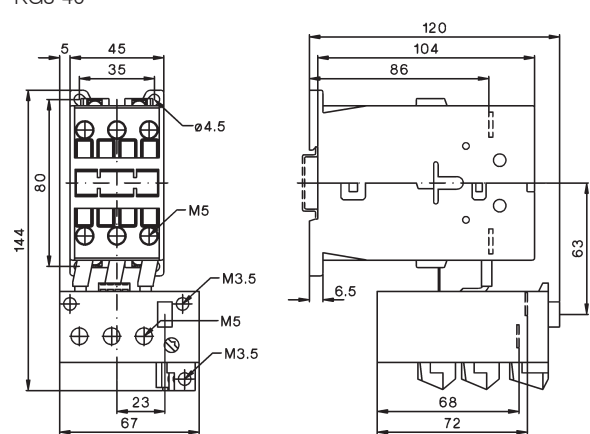

U3/32SM

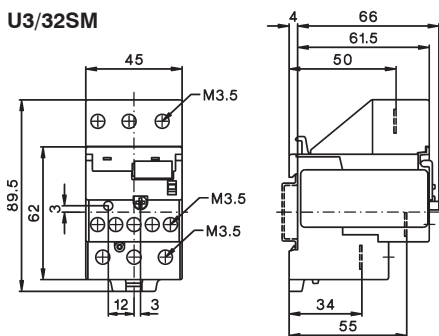

U3/42G + LG5830-

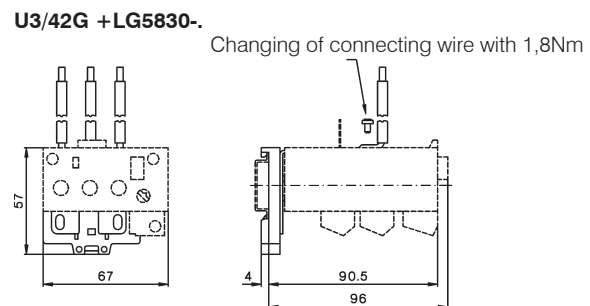



# Thermal Overload Relays

## Dimensions

K1-09 + U12/16..K1  
K1-12

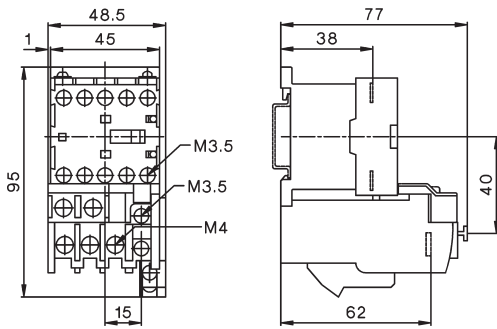

K3-10 + U12/16..K3  
K3-14  
K3-18  
K3-22

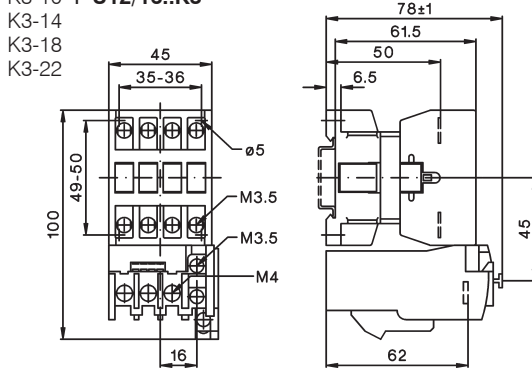

K3-10N + U12/16..K3  
K3-14N  
K3-18N  
K3-22N

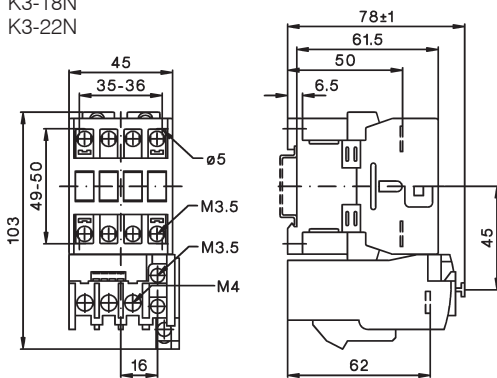

KG3-10 + U12/16..K3  
KG3-14  
KG3-18  
KG3-22

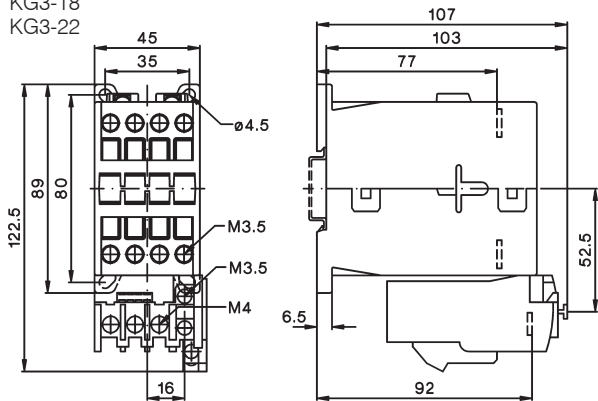

## U12SM K3

U12/16..K3 + U12SM K3 for snap-on 35mm DIN-rail according to DIN EN50022 and screw mounting (single mounting)

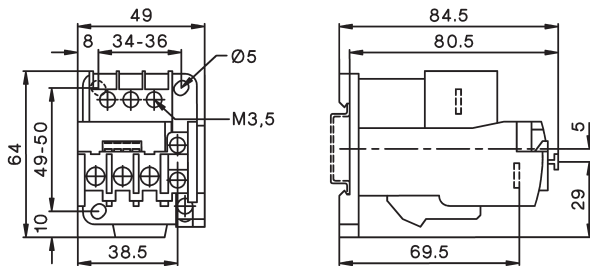

K3-50 + U3/74  
K3-62  
K3-74

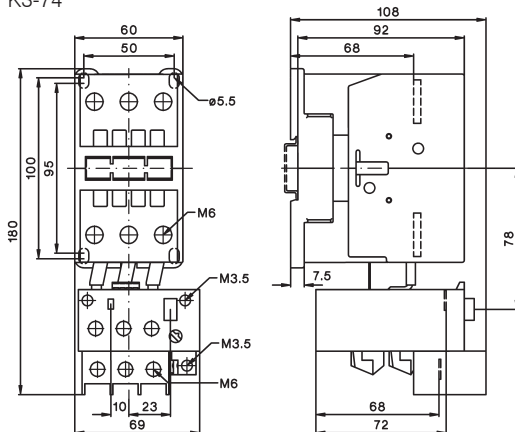



# Thermal Overload Relays

## Dimensions

### U800

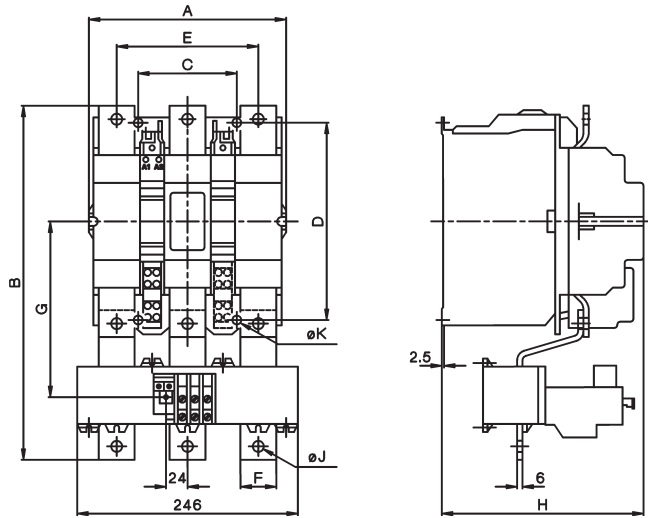
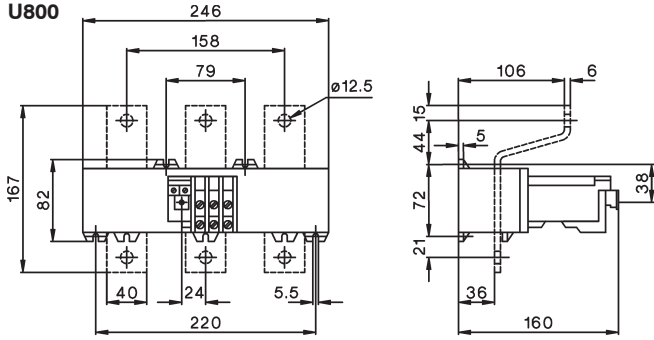

| U800 with     | A   | B   | C   | D   | E   | F  | G   | H   | J    | K  |
|---------------|-----|-----|-----|-----|-----|----|-----|-----|------|----|
| <b>K3-450</b> | 220 | 372 | 110 | 220 | 158 | 40 | 185 | 225 | 12,5 | 9  |
| <b>K3-550</b> | 220 | 395 | 110 | 220 | 158 | 40 | 196 | 225 | 12,5 | 9  |
| <b>K3-700</b> | 280 | 487 | 175 | 280 | 202 | 50 | 257 | 291 | 14,5 | 11 |
| <b>K3-860</b> | 280 | 540 | 175 | 280 | 202 | 50 | 280 | 291 | 14,5 | 11 |

### UAT21

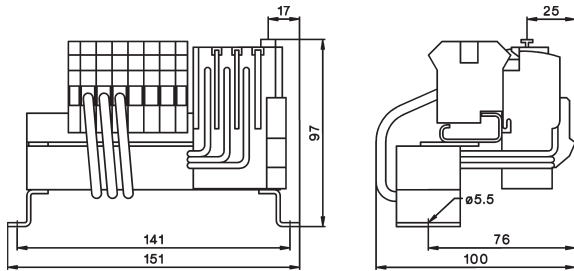

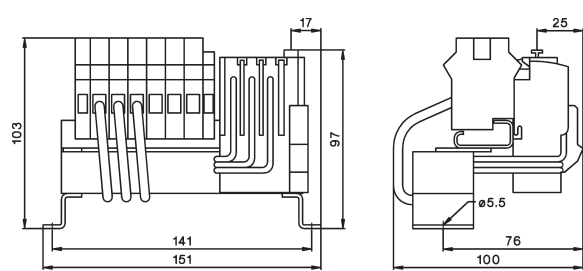

### UAT22

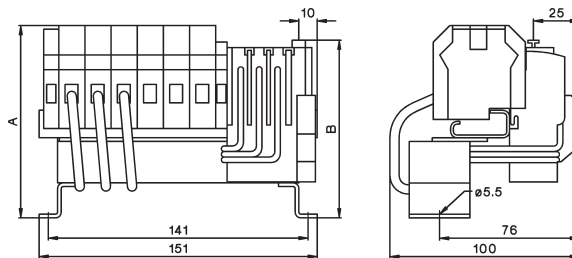

### UAT23

| Type            | Setting Range | A     | B    |
|-----------------|---------------|-------|------|
| <b>UAT23 37</b> | 23-37A        | 105,5 | 97,5 |
| <b>UAT23 49</b> | 32-49A        | 94    | 86   |
| <b>UAT23 72</b> | 48-72A        | 94    | 86   |



|   |  |            |
|---|--|------------|
|    | Modular Contactors                     | 134        |
|    | Auxiliary Contact Block<br>Accessories | 135<br>135 |
|   | Switching Of Lamps                     | 136        |
|  | Technical Data                         | 138        |
|  | Dimensions                             | 140        |

# Modular Contactors

| Rated Current | Heating Power AC1 at |            | Type  | coil voltage                 | Pack pcs. | Weight kg/pc. | Wiring Diagram |
|---------------|----------------------|------------|-------|------------------------------|-----------|---------------|----------------|
|               | 1-phase              | 3-phase    |       |                              |           |               |                |
| 400V<br>A     | 230V<br>kW           | 400V<br>kW | 24    | 24V 50/60Hz                  | ↓         |               |                |
|               |                      |            | 230   | 220-240V 50Hz, 230-264V 60Hz |           |               |                |
|               |                      |            | 24VM  | 24V 50/60Hz, 24V DC          |           |               |                |
|               |                      |            | 230VM | 220-240V 50/60Hz, 220V DC    |           |               |                |

## One-pole 1 module (17,5mm), AC-operated (low noise)



|    |     |   |            |    |      |
|----|-----|---|------------|----|------|
| 20 | 4,6 | - | R20-10 24  | 12 | 0,12 |
| 20 | 4,6 | - | R20-10 230 | 12 | 0,12 |



## Two-pole 1 module (17,5mm), AC-operated (low noise)



|    |     |   |            |    |      |
|----|-----|---|------------|----|------|
| 20 | 4,6 | - | R20-20 24  | 12 | 0,12 |
| 20 | 4,6 | - | R20-20 230 | 12 | 0,12 |

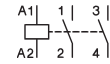

|    |     |   |            |    |      |
|----|-----|---|------------|----|------|
| 20 | 4,6 | - | R20-11 24  | 12 | 0,12 |
| 20 | 4,6 | - | R20-11 230 | 12 | 0,12 |

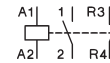

|    |     |   |            |    |      |
|----|-----|---|------------|----|------|
| 20 | 4,6 | - | R20-02 24  | 12 | 0,12 |
| 20 | 4,6 | - | R20-02 230 | 12 | 0,12 |

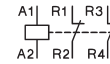

|    |     |   |            |    |      |
|----|-----|---|------------|----|------|
| 25 | 5,5 | - | R25-20 24  | 12 | 0,14 |
| 25 | 5,5 | - | R25-20 230 | 12 | 0,14 |

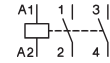

|    |     |   |            |    |      |
|----|-----|---|------------|----|------|
| 25 | 5,5 | - | R25-11 24  | 12 | 0,14 |
| 25 | 5,5 | - | R25-11 230 | 12 | 0,14 |

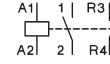

|    |     |   |            |    |      |
|----|-----|---|------------|----|------|
| 25 | 5,5 | - | R25-02 24  | 12 | 0,14 |
| 25 | 5,5 | - | R25-02 230 | 12 | 0,14 |

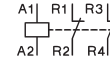

## Four-pole 2 modules (35mm) <sup>1)</sup>, AC-operated (low noise)



|    |     |    |            |   |      |
|----|-----|----|------------|---|------|
| 25 | 5,7 | 17 | R25-40 24  | 6 | 0,21 |
| 25 | 5,7 | 17 | R25-40 230 | 6 | 0,21 |

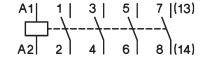

|    |     |    |            |   |      |
|----|-----|----|------------|---|------|
| 25 | 5,7 | 17 | R25-31 24  | 6 | 0,21 |
| 25 | 5,7 | 17 | R25-31 230 | 6 | 0,21 |

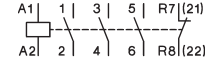

|    |     |    |            |   |      |
|----|-----|----|------------|---|------|
| 25 | 5,7 | 17 | R25-13 24  | 6 | 0,21 |
| 25 | 5,7 | 17 | R25-13 230 | 6 | 0,21 |

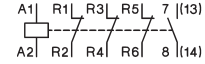

|    |     |   |            |   |      |
|----|-----|---|------------|---|------|
| 25 | 5,7 | - | R25-22 24  | 6 | 0,21 |
| 25 | 5,7 | - | R25-22 230 | 6 | 0,21 |

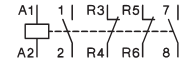

|    |     |    |            |   |      |
|----|-----|----|------------|---|------|
| 25 | 5,7 | 17 | R25-04 24  | 6 | 0,21 |
| 25 | 5,7 | 17 | R25-04 230 | 6 | 0,21 |

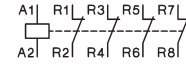

## Four-pole 2 modules(35mm), AC/DC-operated <sup>1)</sup>, (hum free)



|    |     |    |              |   |      |
|----|-----|----|--------------|---|------|
| 25 | 5,7 | 17 | R25-40 24VM  | 6 | 0,22 |
| 25 | 5,7 | 17 | R25-40 230VM | 6 | 0,22 |

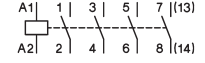

|    |     |    |              |   |      |
|----|-----|----|--------------|---|------|
| 25 | 5,7 | 17 | R25-31 24VM  | 6 | 0,22 |
| 25 | 5,7 | 17 | R25-31 230VM | 6 | 0,22 |

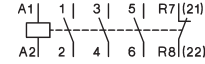

|    |     |    |              |   |      |
|----|-----|----|--------------|---|------|
| 25 | 5,7 | 17 | R25-13 24VM  | 6 | 0,22 |
| 25 | 5,7 | 17 | R25-13 230VM | 6 | 0,22 |

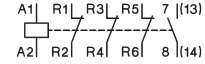

|    |     |   |              |   |      |
|----|-----|---|--------------|---|------|
| 25 | 5,7 | - | R25-22 24VM  | 6 | 0,22 |
| 25 | 5,7 | - | R25-22 230VM | 6 | 0,22 |

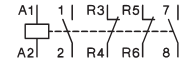

|    |     |    |              |   |      |
|----|-----|----|--------------|---|------|
| 25 | 5,7 | 17 | R25-04 24VM  | 6 | 0,22 |
| 25 | 5,7 | 17 | R25-04 230VM | 6 | 0,22 |

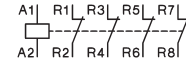

1) Sealable with Sealing Cover P721, available aux. contact block RH11(see page 135)  
 2) Sealable with Sealing Cover P721, available aux. contact block RH11-1(see page 135)

# Modular Contactors

| Rated Current | Heating Power AC1 at         | Type      | coil voltage                                | Pack pcs. | Weight kg/pc. | Wiring Diagram |
|---------------|------------------------------|-----------|---|-----------|---------------|----------------|
| 400V          | 1-phase 230V<br>3-phase 400V | 24<br>230 | 24V 50/60Hz<br>220-240V 50Hz, 230-264V 60Hz |           |               |                |
| A             | kW                           |           |   |           |               |                |

## Two-pole 2 modules (35mm), AC-operated (low noise)



| Rated Current | Heating Power | Type       | Pack pcs. | Weight kg/pc. | Wiring Diagram |
|---------------|---------------|------------|-----------|---------------|----------------|
| 40            | 9             | R40-20 24  | 6         | 0,23          |                |
| 40            | 9             | R40-20 230 | 6         | 0,23          |                |
| 40            | 9             | R40-02 24  | 6         | 0,23          |                |
| 40            | 9             | R40-02 230 | 6         | 0,23          |                |
| 63            | 14,3          | R63-20 24  | 6         | 0,23          |                |
| 63            | 14,3          | R63-20 230 | 6         | 0,23          |                |
| 63            | 14,3          | R63-02 24  | 6         | 0,23          |                |
| 63            | 14,3          | R63-02 230 | 6         | 0,23          |                |

## Four-pole 3 modules (52,5mm)<sup>1)</sup>, AC-operated (low noise)



| Rated Current | Heating Power | Type       | Pack pcs. | Weight kg/pc. | Wiring Diagram |
|---------------|---------------|------------|-----------|---------------|----------------|
| 40            | 9             | R40-40 24  | 4         | 0,35          |                |
| 40            | 9             | R40-40 230 | 4         | 0,35          |                |
| 40            | 9             | R40-31 24  | 4         | 0,35          |                |
| 40            | 9             | R40-31 230 | 4         | 0,35          |                |
| 40            | 9             | R40-22 24  | 4         | 0,35          |                |
| 40            | 9             | R40-22 230 | 4         | 0,35          |                |
| 40            | 9             | R40-04 24  | 4         | 0,35          |                |
| 40            | 9             | R40-04 230 | 4         | 0,35          |                |
| 63            | 14,3          | R63-40 24  | 4         | 0,36          |                |
| 63            | 14,3          | R63-40 230 | 4         | 0,36          |                |
| 63            | 14,3          | R63-31 24  | 4         | 0,36          |                |
| 63            | 14,3          | R63-31 230 | 4         | 0,36          |                |
| 63            | 14,3          | R63-22 24  | 4         | 0,36          |                |
| 63            | 14,3          | R63-22 230 | 4         | 0,36          |                |
| 63            | 14,3          | R63-04 24  | 4         | 0,36          |                |
| 63            | 14,3          | R63-04 230 | 4         | 0,36          |                |

## Auxiliary Contact Block 1/2 module (8,8mm)<sup>2)</sup> for contactor R25, R40, R63 (4p.) max. 1 piece for contactor R40 and R63 (2p.) max. 1 piece



| Rated current | Type   | Pack pcs. | Weight kg/pc. | Wiring Diagram |
|---------------|--------|-----------|---------------|----------------|
| AC15          | RH11   | 3         | 0,026         |                |
| 230V          | RH11-1 | 3         | 0,026         |                |

## Accessories



| Accessories   | Type     | Pack pcs. | Weight kg/pc. |
|---|----------|-----------|---------------|
| RC-unit 2x for R20.. to R63.. for 12V to 250V AC 220nF / 100 Ohm not for R25-..VM | RC-R 230 | 2         | 0,05          |
| Spacing piece 1/2 module (8,8mm) for R20.. to R63.. for ambient temperature >40°C | P730     | 10        | 0,012         |
| Sealing cover for R25.. (4p.)   | P721     | 10        | 0,002         |
| Sealing cover for R40-.., R63-..  | P690     | 10        | 0,003         |

1) Sealable with Sealing Cover P690, available aux. contact block RH11  
 2) Contacts suitable for electronic circuits, according to IEC60947-5-4 for rated voltage 24V DC (test ratings 17V DC, 5mA). Mirror contacts acc. IEC60947-4-1 Annex F.  
 3) AC-operated R25-... 4-pole

## Modular Contactors

### Switching of lamps

| Lamp Type  | Power<br>W  | Current<br>A | Capacitors<br>µF | Max. lamps per pole at 230V 50Hz and max. 60°C |         |         |         |
|--|---|--------------|------------------|--|---------|---------|---------|
|  |   |              |                  | R20..  | R25..   | R40..   | R63..   |
| <b>Incandescent lamps</b>  | 60  | 0,27         | -                | 36   | 50      | 92      | 129     |
|  | 100   | 0,45         | -                | 21   | 30      | 55      | 77      |
|  | 200   | 0,91         | -                | 10   | 15      | 27      | 38      |
|  | 300   | 1,36         | -                | 7  | 10      | 19      | 26      |
|  | 500   | 2,27         | -                | 4  | 6       | 11      | 16      |
|  | 1000  | 4,5          | -                | 2  | 3       | 6       | 8       |
| <b>Fluorescent lamps</b><br>uncompensated or<br>serial compensated                       | 11  | 0,16         | 1,3              | 60   | 75      | 210     | 310     |
|  | 18  | 0,37         | 2,7              | 25   | 30      | 90      | 140     |
|  | 24  | 0,35         | 2,5              | 25   | 30      | 90      | 140     |
|  | 36  | 0,43         | 3,4              | 20   | 25      | 70      | 140     |
|  | 58  | 0,67         | 5,3              | 14   | 17      | 45      | 70      |
|  | 65  | 0,67         | 5,3              | 13   | 16      | 40      | 65      |
|  | 85  | 0,8          | 5,3              | 11   | 14      | 35      | 60      |
|  | <b>Fluorescent lamps</b><br>dual-connection                             | 11           | 0,07             | -  | 2 x 100 | 2 x 110 | 2 x 220 |
| 18   |   | 0,11         | -                | 2 x 50   | 2 x 55  | 2 x 130 | 2 x 200 |
| 24   |   | 0,14         | -                | 2 x 40   | 2 x 44  | 2 x 110 | 2 x 160 |
| 36   |   | 0,22         | -                | 2 x 30   | 2 x 33  | 2 x 70  | 2 x 100 |
| 58   |   | 0,35         | -                | 2 x 20   | 2 x 22  | 2 x 45  | 2 x 70  |
| 65   |   | 0,35         | -                | 2 x 15   | 2 x 16  | 2 x 40  | 2 x 60  |
| 85   |   | 0,47         | -                | 2 x 10   | 2 x 11  | 2 x 30  | 2 x 40  |
| <b>Fluorescent lamps</b><br>parallel compensated   |   | 11           | 0,09             | 2  | 33      | 43      | 67      |
|  | 18  | 0,13         | 2                | 25   | 32      | 50      | 80      |
|  | 24  | 0,16         | 3                | 25   | 32      | 50      | 80      |
|  | 36  | 0,27         | 4                | 22   | 32      | 50      | 80      |
|  | 58  | 0,45         | 7                | 14   | 18      | 36      | 46      |
|  | 65  | 0,5          | 7                | 14   | 18      | 36      | 46      |
|  | 85  | 0,6          | 8                | 12   | 16      | 33      | 44      |
|  | <b>Fluorescent lamps</b><br>with electronic fluorescent<br>lamp ballast | 18           | 0,09             | -  | 40      | 40      | 100     |
| 36   |   | 0,16         | -                | 20   | 20      | 52      | 75      |
| 58   |   | 0,25         | -                | 15   | 15      | 30      | 55      |
| 80   |   | 0,4          | -                | 7  | 10      | 20      | 30      |
| 2 x 18   |   | 0,17         | -                | 20   | 20      | 50      | 60      |
| 2 x 28   |   | 0,25         | -                | 15   | 15      | 37      | 45      |
| 2 x 36   |   | 0,32         | -                | 10   | 10      | 25      | 30      |
| 2 x 58   |   | 0,49         | -                | 7  | 7       | 15      | 20      |
| 2 x 80   |   | 0,7          | -                | 4  | 4       | 8       | 10      |
| <b>Transformers</b><br>for metal halid<br>low voltage lamps                              |   | 20           | 0,09             | -  | 40      | 52      | 110     |
|  | 50  | 0,22         | -                | 20   | 24      | 50      | 80      |
|  | 75  | 0,33         | -                | 13   | 16      | 35      | 54      |
|  | 100   | 0,43         | -                | 10   | 12      | 27      | 43      |
|  | 150   | 0,65         | -                | 7  | 9       | 19      | 29      |
|  | 200   | 0,87         | -                | 5  | 5       | 14      | 23      |
|  | 300   | 1,3          | -                | 3  | 4       | 9       | 14      |
| <b>Mercury-vapour lamps</b><br>(high-pressure lamps),<br>uncompensated<br>e. g. HQL, HPL | 50  | 0,61         | -                | 16   | 21      | 38      | 55      |
|  | 80  | 0,8          | -                | 12   | 16      | 29      | 40      |
|  | 125   | 1,15         | -                | 8  | 11      | 20      | 28      |
|  | 250   | 2,15         | -                | 4  | 6       | 11      | 15      |
|  | 400   | 3,25         | -                | 3  | 4       | 7       | 10      |
|  | 700   | 5,4          | -                | 1  | 2       | 4       | 6       |
|  | 1000  | 7,5          | -                | 1  | 1       | 3       | 4       |
| <b>Mercury-vapour lamps</b><br>(high-pressure lamps),<br>compensated<br>e. g. HQL, HPL   | 50  | 0,28         | 7                | 14   | 18      | 36      | 50      |
|  | 80  | 0,41         | 8                | 12   | 16      | 31      | 44      |
|  | 125   | 0,65         | 10               | 10   | 13      | 25      | 35      |
|  | 250   | 1,22         | 18               | 5  | 7       | 14      | 19      |
|  | 400   | 1,95         | 25               | 4  | 5       | 10      | 14      |
|  | 700   | 3,45         | 45               | 2  | 3       | 6       | 8       |
|  | 1000  | 4,8          | 60               | 1  | 2       | 4       | 6       |

# Modular Contactors

## Switching of lamps

| Lamp Type   | Power<br>W  | Current<br>A | Capacitors<br>μF | Max. lamps per pole at 230V 50Hz and max. 60°C  |       |       |       |    |
|---|---|--------------|------------------|---|-------|-------|-------|----|
|   |   |              |                  | R20..   | R25.. | R40.. | R63.. |    |
| <b>Metal halide lamps</b><br>uncompensated<br>e. g. HQI, HPI, CDM   | 35  | 0,53         | -                | 22  | 24    | 57    | 65    |    |
|   | 70  | 1            | -                | 12  | 14    | 30    | 35    |    |
|   | 150   | 1,8          | -                | 6   | 8     | 17    | 18    |    |
|   | 250   | 3            | -                | 4   | 5     | 10    | 12    |    |
|   | 400   | 3,5          | -                | 3   | 4     | 8     | 10    |    |
|   | 1000  | 9,5          | -                | 1   | 1     | 3     | 4     |    |
|   | 2000  | 16,5         | -                | -   | -     | 2     | 2     |    |
|   | 400V per pole   | 2000         | 10,5             | -   | -     | 2     | 2     |    |
|   | 3500  | 18           | -                | -   | 1     | 1     |       |    |
|   | <b>Metal halide lamps</b><br>compensated<br>e. g. HQI, HPI, CDM | 35           | 0,25             | 6   | 16    | 21    | 42    | 58 |
| 70  |   | 0,45         | 12               | 8   | 11    | 21    | 29    |    |
| 150   |   | 0,75         | 20               | 5   | 7     | 13    | 18    |    |
| 250   |   | 1,5          | 33               | 3   | 4     | 9     | 11    |    |
| 400   |   | 2,1          | 35               | 2   | 4     | 9     | 10    |    |
| 1000  |   | 5,8          | 95               | 1   | 1     | 3     | 4     |    |
| 2000  |   | 11,5         | 148              | -   | -     | 2     | 2     |    |
| 400V per pole   |   | 2000         | 6,6              | 58  | -     | -     | 3     | 4  |
| 3500  |   | 11,6         | 100              | -   | -     | 2     | 3     |    |
| <b>Metal halide lamps</b><br>with electronic fluorescent<br>with electronic fluorescent<br>lamp ballast (e. g.: PCI)<br>50-125 x I <sub>nlamp</sub> for 0,6ms |   | 20           | 0,1              | integrated  | 9     | 9     | 18    | 20 |
|   | 28  | 0,15         | integrated       | -   | -     | -     | 18    |    |
|   | 35  | 0,2          | integrated       | 6   | 6     | 11    | 13    |    |
|   | 70  | 0,36         | integrated       | 5   | 5     | 10    | 12    |    |
|   | 150   | 0,7          | integrated       | 4   | 4     | 8     | 10    |    |
| <b>Sodium-vapour lamps</b><br>(low pressure lamps),<br>uncompensated  | 35  | 1,5          | -                | 7   | 9     | 22    | 30    |    |
|   | 55  | 1,5          | -                | 7   | 9     | 22    | 30    |    |
|   | 90  | 2,4          | -                | 4   | 6     | 13    | 19    |    |
|   | 135   | 3,3          | -                | 3   | 4     | 10    | 14    |    |
|   | 150   | 3,3          | -                | 3   | 4     | 10    | 14    |    |
|   | 180   | 3,3          | -                | 3   | 4     | 10    | 14    |    |
|   | 200   | 3,3          | -                | 3   | 4     | 10    | 14    |    |
|   |   |              |                  |   |       |       |       |    |
| <b>Sodium-vapour lamps</b><br>(low pressure lamps),<br>compensated  | 35  | 0,31         | 20               | 5   | 6     | 15    | 18    |    |
|   | 55  | 0,42         | 20               | 5   | 6     | 15    | 18    |    |
|   | 90  | 0,63         | 30               | 3   | 4     | 10    | 12    |    |
|   | 135   | 0,94         | 45               | 2   | 3     | 7     | 8     |    |
|   | 150   | 1            | 40               | 2   | 3     | 8     | 9     |    |
|   | 180   | 1,16         | 40               | 2   | 3     | 8     | 9     |    |
| <b>Sodium-vapour lamps</b><br>(high pressure lamps),<br>uncompensated   | 150   | 1,8          | -                | 5   | 8     | 17    | 22    |    |
|   | 250   | 3            | -                | 4   | 5     | 10    | 13    |    |
|   | 330   | 3,7          | -                | 3   | 4     | 8     | 10    |    |
|   | 400   | 4,7          | -                | 2   | 3     | 6     | 8     |    |
|   | 1000  | 10,3         | -                | 1   | 1     | 3     | 4     |    |
| <b>Sodium-vapour lamps</b><br>(high pressure lamps),<br>compensated   | 150   | 0,83         | 20               | 5   | 7     | 20    | 25    |    |
|   | 250   | 1,5          | 33               | 3   | 4     | 12    | 15    |    |
|   | 330   | 2            | 40               | 2   | 3     | 10    | 13    |    |
|   | 400   | 2,4          | 48               | 2   | 2     | 8     | 12    |    |
| 1000  | 6,3   | 106          | 1                | 1   | 4     | 6     |       |    |
| <b>Sodium-vapour lamps</b><br>(high pressure lamps)<br>with serial electronic<br>(e. g.: PCI)<br>50-125 x I <sub>nlamp</sub> for 0,6ms                        | 20  | 0,1          | integrated       | 9   | 9     | 18    | 20    |    |
|   | 35  | 0,2          | integrated       | 6   | 6     | 11    | 13    |    |
|   | 70  | 0,36         | integrated       | 5   | 5     | 10    | 12    |    |
|   | 150   | 0,7          | integrated       | 4   | 4     | 8     | 10    |    |
| <b>LED-Lamps</b><br>consider the inrush current<br>of the lamp ballast and<br>the cosφ of the lamp  | max. inrush current of contactor [A]                            |              |                  | 195A  | 233A  | 424A  | 565A  |    |
|   | inrush current of contactor<br>inrush current of lamp/EVG       |              |                  | = max. lamps per pole at 230V 50Hz and max. 60°C (I <sub>nLED</sub> ≤ I <sub>tr</sub> ) |       |       |       |    |



# Modular Contactors

Data according to IEC60 947-4-1, IEC 60947-5-1, VDE 0660-5-1

| Type   | 2-pole                 |                        |                      |            | 4-pole                 |                     |            | RH11       |      |
|--|------------------------|------------------------|----------------------|------------|------------------------|---------------------|------------|------------|------|
|  | R20 (VM) <sup>3)</sup> | R25 (VM) <sup>3)</sup> | R40                  | R63        | R25 (VM) <sup>3)</sup> | R40                 | R63        |            |      |
| <b>Main Contacts</b> <sup>4) 5) 6)</sup>                             |                        |                        |                      |            |                        |                     |            |            |      |
| <b>Rated insulation voltage U<sub>i</sub><sup>1)</sup></b>           | V~                     | <b>440</b>             | <b>440</b>           | <b>440</b> | <b>440</b>             | <b>440</b>          | <b>440</b> | <b>440</b> |      |
| Rated operation voltage U <sub>e</sub>                               | V~                     | 440                    | 440                  | 440        | 440                    | 440                 | 440        | 440        |      |
| <b>Frequency of operations z</b> AC1, AC3                            | 1/h                    | 300                    | 300                  | 600        | 600                    | 300                 | 600        | 600        |      |
| <b>Mechanical life</b>   | S x 10 <sup>6</sup>    | 1                      | 1                    | 1          | 1                      | 1                   | 1          | 1          |      |
| <b>Utilization category AC1 / AC7a</b>                               |                        |                        |                      |            |                        |                     |            |            |      |
| <b>Switching of resistive load</b>                                   |                        |                        |                      |            |                        |                     |            |            |      |
| Rated operational current I <sub>e</sub> (=I <sub>th</sub> )<br>open | A                      | 20                     | 25                   | 40         | 63                     | 25                  | 40         | 63         | -    |
| <b>Contact life</b>  | S x 10 <sup>6</sup>    | 0,1                    | 0,1                  | 0,1        | 0,1                    | 0,1                 | 0,1        | 0,1        | -    |
| <b>Minimum Switch Voltage</b>  | V/mA                   | 24/100                 | 24/100               | 24/100     | 24/100                 | 24/100              | 24/100     | 24/100     | 17/5 |
| <b>Short time current</b><br>10s-current                             | A                      | 72                     | 72                   | 216        | 240                    | 72                  | 216        | 240        | -    |
| <b>Power loss</b> per pole at I <sub>e</sub> /AC1                    | W                      | 2                      | 3                    | 3          | 7                      | 2                   | 3          | 7          | 0,5  |
| <b>Utilization category AC2 and AC3 / AC7b</b>                       |                        |                        |                      |            |                        |                     |            |            |      |
| <b>Switching of three-phase motors</b>                               |                        |                        |                      |            |                        |                     |            |            |      |
| Rated operational current I <sub>e</sub>                             | A                      | -                      | -                    | -          | -                      | 9                   | 27         | 30         | -    |
| Rated operational power<br>of three-phase motors                     |                        | -                      | -                    | -          | -                      | 2,2                 | 7,5        | 8          | -    |
| 50-60Hz  | 220V kW                | -                      | -                    | -          | -                      | 2,5                 | 8          | 8,5        | -    |
|  | 230-240V kW            | -                      | -                    | -          | -                      | 4                   | 12,5       | 15         | -    |
|  | 380-415V kW            | -                      | -                    | -          | -                      | -                   | -          | -          | -    |
| 2-pole motors  | 230V kW                | 1,1 <sup>2)</sup>      | 1,3                  | 2,6        | 5                      | -                   | -          | -          | -    |
| <b>Contact life</b>  | S x 10 <sup>6</sup>    | 0,15                   | 0,15                 | 0,15       | 0,15                   | 0,15                | 0,15       | 0,15       | -    |
| <b>Power consumption of coils</b>                                    |                        |                        |                      |            |                        |                     |            |            |      |
| AC operated  | inrush VA              | 7 - 9                  | 7 - 9                | -          | -                      | 20 - 25             | 33 - 45    | 33 - 45    | -    |
|  | sealed VA              | 2,2 - 4,2              | 2,2 - 4,2            | 5 - 7      | 5 - 7                  | 4 - 6               | 6 - 8      | 6 - 8      | -    |
|  | W                      | 0,8 - 1,6              | 0,8 - 1,6            | -          | -                      | 1,5 - 2,5           | 2,6        | 2,6        | -    |
| AC and DC-operated   | W                      | -                      | -                    | -          | -                      | 3 - 4               | -          | -          | -    |
| <b>Operation range of coils</b>                                      |                        |                        |                      |            |                        |                     |            |            |      |
| in multiples of control voltage U <sub>s</sub> (-40° - +40°C)        |                        | 0,85 - 1,1             | 0,85 - 1,1           | 0,85 - 1,1 | 0,85 - 1,1             | 0,85 - 1,1          | 0,85 - 1,1 | 0,85 - 1,1 | -    |
| <b>Noise level (operation)<br/>acc. to EN ISO 3744</b>               |                        |                        |                      |            |                        |                     |            |            |      |
| from front, distance 0,5 m   | dB                     | 16 (0) <sup>3)</sup>   | 16 (0) <sup>3)</sup> | 8          | 8                      | 8 (0) <sup>3)</sup> | < 4        | < 4        | -    |

1) Suitable for: earthed-neutral systems, overvoltage category I to III, pollution degree 3 (standard-industry): U<sub>imp</sub> = 4kV.

2) AC7b motor 2-pole 230V 1,1kW

3) 0 dB for contactors type "VM" (AC/DC operated)

4) Rated frequency 50/60Hz

5) Max. occ. switching overvoltage <4kV

6) Duty cycle: 100%

# Modular Contactors

Data according to IEC60 947-4-1, IEC 60947-5-1, VDE 0660-5-1

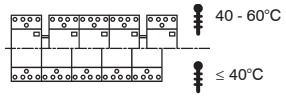
| Type  | R20   | R25 (2p.)  | R25 (4p.)   | R25-..VM   | R40 (2p./4p.)   | R63 (2p./4p.) | RH11       |
|---|---|------------|-------------|------------|---|---------------|------------|
| <b>Maximum ambient temperature</b>                            |   |            |             |            |   |               |            |
| Operation   | open °C   |            | -40 to + 60 |            |  |               |            |
|   | enclosed °C                                       |            | -40 to + 40 |            |   |               |            |
| Storage   |   |            | -50 to + 90 |            |   |               |            |
| <b>Short circuit protection</b>                               |   |            |             |            |   |               |            |
| max. fuse Coordination-type "1"gL (gG)                        | A   | 35         | 35          | 35         | 63  | 80            | -          |
| Rated short circuit current                                   | "I <sub>sc</sub> " kA                             | 3          | 3           | 3          | 3   | 3             | -          |
|   | "I <sub>q</sub> " kA                              | 3          | 3           | 10         | 10  | 10            | -          |
| <b>Switching time</b> at control voltage U <sub>s</sub> ± 10% |   |            |             |            |   |               |            |
| make time   | ms  | 7 - 16     | 7 - 16      | 9 - 15     | 17 - 50   | 11 - 15       | 11 - 15    |
| release time  | ms  | 6 - 12     | 6 - 12      | 4 - 8      | 17 - 23   | 6 - 13        | 6 - 13     |
| arc duration  | ms  | 10 - 15    | 10 - 15     | 10 - 15    | 10 - 15   | 10 - 15       | 10 - 15    |
| <b>Cable cross-sections</b>                                   |   |            |             |            |   |               |            |
| Main connector  | solid or stranded mm <sup>2</sup>                 | 1,5 - 10   | 1,5 - 10    | 1,5 - 10   | 1,5 - 10  | 2,5 - 25      | 2,5 - 25   |
|   | flexible mm <sup>2</sup>                          | 1,5 - 6    | 1,5 - 6     | 1,5 - 6    | 1,5 - 6   | 2,5 - 16      | 2,5 - 16   |
|   | flexible with multicore cable end mm <sup>2</sup> | 1,5 - 6    | 1,5 - 6     | 1,5 - 6    | 1,5 - 6   | 2,5 - 16      | 2,5 - 16   |
| Clamps per pole   |   | 1          | 1           | 1          | 1   | 1             | 2          |
| Magnetic coil   | solid or stranded mm <sup>2</sup>                 | 0,75 - 2,5 | 0,75 - 2,5  | 0,75 - 2,5 | 0,75 - 2,5  | 0,75 - 2,5    | 0,75 - 2,5 |
|   | flexible mm <sup>2</sup>                          | 0,5 - 2,5  | 0,5 - 2,5   | 0,5 - 2,5  | 0,5 - 2,5   | 0,5 - 2,5     | 0,5 - 2,5  |
|   | flexible with multicore cable end mm <sup>2</sup> | 0,5 - 1,5  | 0,5 - 2,5   | 0,5 - 1,5  | 0,5 - 1,5   | 0,5 - 1,5     | 0,5 - 1,5  |
| Clamps per pole   |   | 1          | 1           | 1          | 1   | 1             | -          |
| <b>Auxiliary Contacts</b> <sup>4) 5) 6)</sup>                 |   |            |             |            |   |               |            |
| Rated insulation voltage U <sub>i</sub> <sup>1)</sup>         | V AC  | -          | -           | 440        | 440   | 440           | 440        |
| Thermal rated current I <sub>th</sub>                         | 40°C A  | -          | -           | 25         | 25  | 40            | 63         |
| Ambient temperature   | 60°C A  | -          | -           | 25         | 25  | 40            | 63         |
| <b>Utilization category AC15</b>                              |   |            |             |            |   |               |            |
| Rated operational current I <sub>e</sub>                      | 220-240V A  | -          | -           | 3          | 3   | 3             | 3          |
|   | 380-415V A  | -          | -           | 2          | 2   | 2             | 2          |
|   | 440V A  | -          | -           | 1,6        | 1,6   | 1,6           | 1,6        |
| <b>Utilization category DC13</b>                              |   |            |             |            |   |               |            |
| Rated operational current I <sub>e</sub>                      | 24-60V A  | -          | -           | 2          | 2   | 2             | 2          |
|   | 110V A  | -          | -           | 0,4        | 0,4   | 0,4           | 0,4        |
| per pole  | 220V A  | -          | -           | 0,1        | 0,1   | 0,1           | 0,1        |
| <b>Short circuit protection</b>                               |   |            |             |            |   |               |            |
| short-circuit current 1kA, contact welding not accepted       |   |            |             |            |   |               |            |
| max. fuse size  | gL (gG) A   | -          | -           | 10         | 10  | 10            | 10         |

## Data according to UL508

| Main Contacts (cULus)  | Type                | R20  | R25 (2p.) | R25 (4p.) | R40 (2p./4p.) | R63 (2p./4p.) | RH11 |
|--|---------------------|------|-----------|-----------|---------------|---------------|------|
| Rated operational current "General Use"                      | A                   | 20   | 25        | 25        | 40            | 63            | 10   |
| Rated operational power of three-phase motors at 60Hz (3ph)  | 110-120V hp         | -    | -         | 1         | 2             | 3             | -    |
|  | 200-208V hp         | -    | -         | 2         | 5             | 7½            | -    |
|  | 220-240V hp         | -    | -         | 3         | 7½            | 10            | -    |
|  | 265-277V hp         | -    | -         | 3         | 7½            | 10            | -    |
| Rated operational power of AC motors at 60Hz (1ph)           | 110-120V hp         | ½    | ½         | ½         | 1             | 1½            | -    |
|  | 200-208V hp         | 1    | 1         | 1         | 2             | 3             | -    |
|  | 220-240V hp         | 1½   | 1 ½       | 1½        | 3             | 5             | -    |
|  | 265-277V hp         | 1½   | 2         | 2         | 3             | 5             | -    |
| Fuses  | A                   | 40   | 40        | 40        | 80            | 80            | -    |
| Suitable for use on a capability of delivering not more than | rms A               | 5000 | 5000      | 5000      | 5000          | 5000          | -    |
|  | V                   | 300  | 300       | 300       | 300           | 300           | 300  |
| Rated operation voltage                                      | V~                  | 300  | 300       | 300       | 300           | 300           | 300  |
| <b>Auxiliary Contacts (cULus)</b>                            | heavy pilot duty AC | -    | -         | -         | -             | -             | C300 |

1) Suitable for: earthed-neutral systems, overvoltage category I to III, pollution degree 3 (standard-industry): U<sub>imp</sub> = 4kV.

3) Maximum cable cross-section with prepared conductor

4) Rated frequency 50/60Hz

5) Max. occ. switching overvoltage <4kV

6) Duty cycle: 100%

# Maße

R20-..., R25-... (2-pole)  
RC-R 230

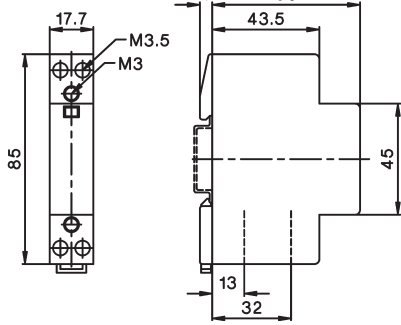

R25-... (4-pole) (+RH11)  
R25-...VM (+RH11-1)

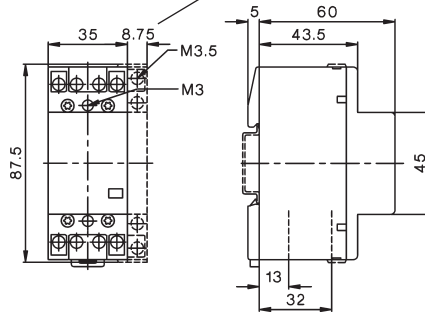

R40-... (2-pole)  
R63-... (2-pole)

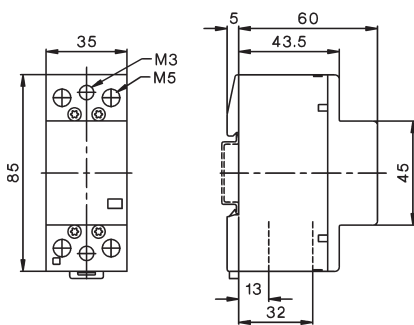

R40-... (4-pole) (+RH11)  
R63-... (4-pole) (+RH11)

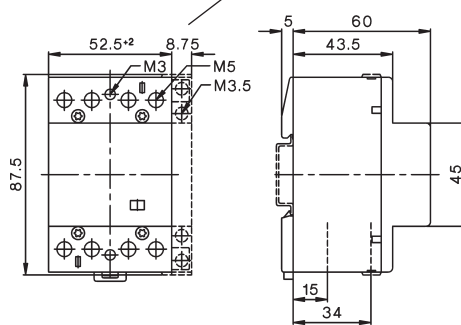

Aux. contact block  
RH11, RH11-1

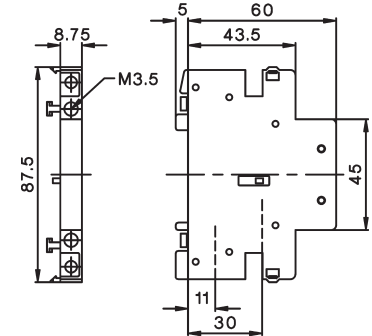

# Contactors for DC-Switching

AC-operated

## Rated Operational Current

DC1

Additional  
Aux.  
Contacts

Coil voltage <sup>1)</sup>  
**230**  
220-230V 50Hz, 240V 60Hz

600V 1000V 1200V

Type

Pack Weight  
pcs. kg/pcs.

Wiring diagram



| Rated Operational Current (DC1) | Additional Aux. Contacts | Type                                  | Coil voltage <sup>1)</sup> | Pack pcs. | Weight kg/pcs. | Wiring diagram |
|---------------------------------|--------------------------|---------------------------------------|----------------------------|-----------|----------------|----------------|
| 20A                             | 2 HKA11                  | <b>K3DC-20A00 ...</b>                 | 220-230V 50Hz, 240V 60Hz   | 1         | 0,5            |                |
| 50A                             | +1 HKT.                  | <b>K3DC-48A00 ...</b>                 |                            | 1         | 0,5            |                |
| 60A                             | 2 HKA11                  | <b>K3DC-60A00...</b>                  | 220-230V 50Hz, 240V 60Hz   | 1         | 1,2            |                |
| 80A                             | +1 HKT.                  | <b>K3DC-80A00 ...</b>                 |                            | 1         | 1,2            |                |
| 100A                            |                          | <b>K3DC-100A00 ...</b>                |                            | 1         | 1,8            |                |
| 12A                             | 2 HKA11 +2 HKT.          | <b>K3PV-12A00 ...</b>                 | 220-230V 50Hz, 240V 60Hz   | 1         | 0,8            |                |
| 30A                             | 2 HKA11                  | <b>K3PV-30A00 ...</b>                 |                            | 1         | 0,9            |                |
| 60A                             | +2 HKT.                  | <b>K3PV-60A00 ...</b>                 | 220-230V 50Hz, 240V 60Hz   | 1         | 0,9            |                |
| 80A                             | 2 HKA11                  | <b>K3PV-80A00 ...</b>                 |                            | 1         | 1,5            |                |
| 100A                            | +1 HKT.                  | <b>K3PV-100A00 ...<sup>2)3)</sup></b> |                            | 1         | 2,3            |                |
| 150A                            | 2 HKA11                  | <b>K3PV-150A00 ...<sup>2)3)</sup></b> | 220-230V 50Hz, 240V 60Hz   | 1         | 5              |                |
| 200A                            | +1 HKT.                  | <b>K3PV-200A00 ...<sup>2)3)</sup></b> |                            | 1         | 5              |                |
| 240A                            |                          | <b>K3PV-240A00 ...<sup>2)3)</sup></b> |                            | 1         | 5              |                |
| 300A                            | 2 HKA11                  | <b>K3PV-300A00 ...<sup>2)3)</sup></b> | 220-230V 50Hz, 240V 60Hz   | 1         | 7,5            |                |
| 400A                            | +1 HKT.                  | <b>K3PV-400A00 ...<sup>2)3)</sup></b> |                            | 1         | 7,5            |                |
| 450A                            |                          | <b>K3PV-450A00 ...<sup>2)3)</sup></b> |                            | 1         | 7,5            |                |

# Contactors for DC-Switching for PV-installations, as remote controlled fire protection defeat device

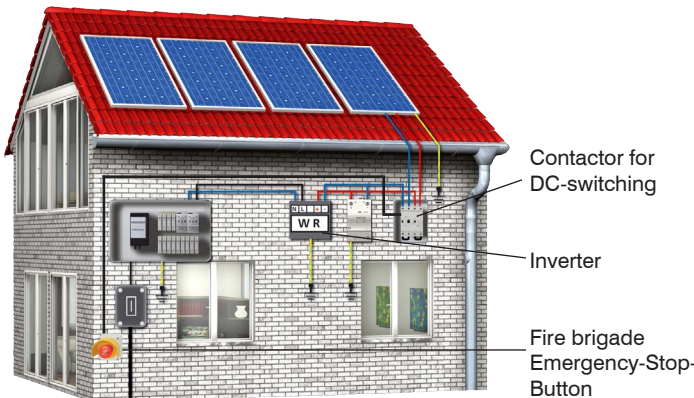

In most Photovoltaic-installations, the switch disconnectors according to IEC 60364-7-712 are integrated in the DC/AC-inverter. So the wires between solar-panels and inverter are continuously under voltage. According to ÖVE-R11-1: 2013, Photovoltaic-installations must have a fire protection defeat device. For this purpose, BENEDICT contactors for DC-switching, used as a fire protection defeat device, can switch off the Photovoltaic-installation with a remote controlled fire brigade Emergency-Stop-button.

Switch diagram (4 contacts)

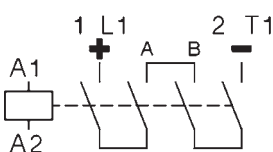

Connection diagram 1-pole

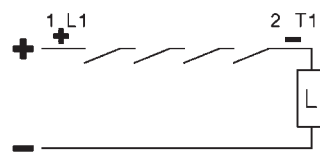



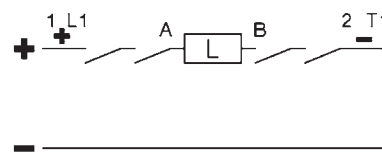







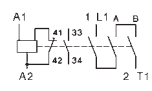

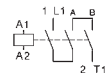
For using as two-poles contactor remove connection A-B

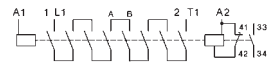

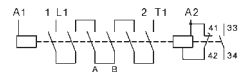

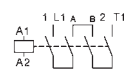
1) Other coil voltages from 24 to 600V AC, on request  
2) Type for AC- and DC-operating: e.g.: 230: 220-240V 50/60Hz and 220V=  
3) With integrated coil suppressor

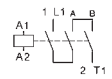
# Contactors for DC-Switching

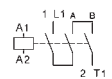
DC-operated

| Type  | Coil voltage <sup>1)</sup> | Aux. Contacts  |                 | Pack pcs.          | Weight kg/pcs. | Wiring diagram |   |
|---|----------------------------|----------------|-----------------|--------------------|----------------|----------------|---|
|   | 24 24V= DC                 | build in NO NC | additional Type |                    |                |                |   |
|    |                            | 1              | -               | 1 HKA11            | 1              | 0,5            |    |
| <b>K3DC-48A10= ...<sup>5)</sup></b>   |                            | 1              | -               | +1 HKT.            | 1              | 0,5            |   |
|    |                            | -              | -               | 1 HKA11            | 1              | 1,2            |    |
| <b>K3DC-80A00= ...<sup>5)</sup></b>   |                            | -              | -               | +1 HKT.            | 1              | 1,2            |   |
| <b>K3DC-100A00= ...<sup>5)</sup></b>  |                            | -              | -               |                    | 1              | 1,8            |   |
|    |                            | 1              | -               | 1 HKA11<br>+2 HKT. | 1              | 0,85           |    |
| <b>K3PV-30A10= ...<sup>5)</sup></b>   |                            | 1              | -               | 1 HKA11            | 1              | 0,95           |   |
|    |                            | 1              | -               | +2 HKT.            | 1              | 0,95           |    |
| <b>K3PV-80A00= ...<sup>5)</sup></b>   |                            | -              | -               | 2 HKA11            | 1              | 1,5            |   |
|    |                            | -              | -               | +1 HKT.            | 1              | 2,3            |    |
| <b>K3PV-150A00 ...<sup>2) 5)</sup></b>  |                            | -              | -               | 2 HKA11            | 1              | 5              |   |
|   |                            | -              | -               | +1 HKT.            | 1              | 5              |    |
| <b>K3PV-240A00 ...<sup>2) 5)</sup></b>  |                            | -              | -               |                    | 1              | 5              |   |
|  |                            | -              | -               | 2 HKA11            | 1              | 7,5            |  |
| <b>K3PV-400A00 ...<sup>2) 5)</sup></b>  |                            | -              | -               | +1 HKT.            | 1              | 7,5            |   |
| <b>K3PV-450A00 ...<sup>2) 5)</sup></b>  |                            | -              | -               |                    | 1              | 7,5            |   |

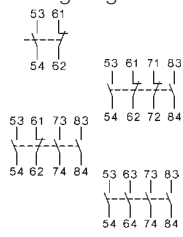
## Auxiliary Contact Blocks for contactors K3DC-.. and K3PV-.., for low level switching<sup>4)</sup>

| Type  | Rated Operational Current |      |      | for contactors     | Pack pcs. | Weight kg/pcs. | Wiring diagrams   |
|---|---------------------------|------|------|--------------------|-----------|----------------|---|
|   | AC15                      | AC15 | AC1  |                    |           |                |   |
|  | 230V                      | 400V | 690V | K3DC, K3PV-.. top  | 1         | 0,04           |  |
| <b>3</b>  | 2                         | 10   |      | K3DC, K3PV-.. top  | 1         | 0,05           |   |
| <b>3</b>  | 2                         | 10   |      | K3DC, K3PV-.. top  | 1         | 0,05           |   |
| <b>3</b>  | 2                         | 10   |      | K3DC, K3PV-.. top  | 1         | 0,05           |   |
|  | <b>3</b>                  | 2    | 10   | K3DC, K3PV-.. side | 1         | 0,05           |  |

## Accessories



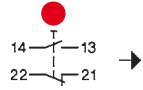











|   |                         |   |      |   |    |
|---|-------------------------|---|------|---|----|
| <b>Fire Brigade-EMERGENCY STOP key operated button</b> Ø40mm, according to EN418, unlock by key | <b>BG10P44S3-11 +SK</b> | 1 | 0,22 |  | 3) |
|---|-------------------------|---|------|---|----|

1) Other coil voltages from 24 to 250V DC, on request  
 2) Type for AC- and DC-operating: e.g.: 24: 24V 50/60Hz and 24V=  
 3) → opener positive opening acc. IEC/EN60947-5-1  
 4) Contacts suitable for electronic circuits, according to IEC60947-5-4 for rated voltage 24V DC (test ratings 17V DC, 5mA) Mirror contacts acc. IEC60947-4-1 Annex F. Technical data see page 78  
 5) With integrated coil suppressor

# Technical Data

Data according to IEC 60947-4-1, VDE 0660

| Type                                     |                 | K3DC-20..   | K3DC-48..   | K3DC-60..   | K3DC-80..   | K3DC-100..  | K3PV-12..   | K3PV-30..   | K3PV-60..   | K3PV-80..   | K3PV-100..  | K3PV-150..  | K3PV-200..  | K3PV-240..  | K3PV-300..  | K3PV-400..  | K3PV-450..  |  |
|--|-----------------|---|---|---|---|---|---|---|---|---|---|---|---|---|---|---|---|--|
| Rated insulation voltage<br>$U_{imp}$    | V=<br>kV        | 600<br>8  | 600<br>8  | 1000<br>8   | 1000<br>8   | 600<br>8  | 1200<br>8   | 1000<br>8   | 1000<br>8   | 1000<br>8   | 1000<br>8   | 1000<br>8   | 1000<br>8   | 1000<br>8   | 1000<br>8   | 1000<br>8   | 1000<br>8   |  |
| poles in series                          |                 | 3   | 3   | 3   | 3   | 3   | 8   | 6   | 6   | 4   | 4   | 3   | 3   | 3   | 3   | 3   | 3   |  |
| DC1 600V dc                              | $I_e$ A         | 20  | 50  | 60  | 80  | 100   | 12  | 30  | 60  | 80  | 100   | 150   | 200   | 240   | 300   | 400   | 450   |  |
| DC1 1000V dc                             | $I_e$ A         | -   | -   | 30  | 60  | -   | 12  | 30  | 60  | 80  | 100   | 150   | 200   | 240   | 300   | 400   | 450   |  |
| DC1 1200V dc                             | $I_e$ A         | -   | -   | -   | -   | -   | 6   | -   | -   | -   | -   | -   | -   | -   | -   | -   | -   |  |
| DC3/5 310V dc                            | $I_e$ A         | -   | -   | -   | 40  | 60  | -   | 15  | 24  | 40  | 90  | 125   | 170   | 200   | 230   | 270   | 300   |  |
| DC3/5 460V dc                            | $I_e$ A         | -   | -   | -   | -   | -   | -   | 15  | 24  | 40  | 40  | 125   | 170   | 200   | 230   | 270   | 300   |  |
| DC3/5 600V dc                            | $I_e$ A         | -   | -   | -   | -   | -   | -   | -   | -   | -   | -   | 50  | 60  | 75  | 120   | 160   | 200   |  |
| Main pole resistance                     | mOhm            | 1,8   | 1,8   | 1,4   | 1,2   | 1   | 2,2   | 1,8   | 1,8   | 1,2   | 1   | 0,5   | 0,5   | 0,35  | 0,15  | 0,15  | 0,15  |  |
| poles in series resistance               | mOhm            | 5,4   | 5,4   | 4,2   | 3,6   | 3   | 17,6  | 10,8  | 10,8  | 4,8   | 4   | 1,5   | 1,5   | 1,1   | 0,5   | 0,5   | 0,5   |  |
| Mechanical life                          | $10^6$          | 10  |   |   |   |   |   |   |   |   |   | 10  |   |   | 8   |   |   |  |
| Protection degree                        |                 | IP20  |   |   |   |   |   |   |   |   |   | IP00 / IP20 <sup>1)</sup>   |   |   | IP00 / IP20 <sup>1)</sup>   |   |   |  |
| Main poles                               |                 |  |  |  |  |  |  |  |  |  |  |  |  |  |  |  |  |  |
| Cable cross sections                     | mm <sup>2</sup> | 2 x 1,5 - 10  |   | 2,5 - 35  |   | 4 - 35<br>+4-50   |   | 2x<br>1,5-2,5   |   | 2 x 1,5 - 10  |   | 2,5-35  |   | 4 - 35<br>+4 - 50   |   | Busbar 18 x 4<br>Screw M8   |   |  |
| Tightening torque                        | Nm              | 2,3 - 2,7   |   | 5 - 6   |   | 8 - 9,6   |   | 1,4 - 1,6   |   | 2,3 - 2,7   |   | 5 - 6   |   | 8 - 9,6   |   | 17 - 20   |   |  |
| Mounting                                 |                 | DIN-rail or screw   |   |   |   | screws  |   | DIN-rail or screws  |   |   |   | Screws  |   | Screws  |   |   |   |  |
| Operating range of coils                 | Uc              | 0,85 - 1,1  |   |   |   |   |   |   |   |   |   |   |   |   |   |   |   |  |
| Power consumption of coils               |                 |   |   |   |   |   |   |   |   |   |   |   |   |   |   |   |   |  |
| AC inrush sealed                         | VA<br>VA/W      | 90<br>9 / 3   |   | 250<br>18 / 4   |   | 180<br>18 / 6   |   | 250<br>18 / 4   |   | 350<br>5 / 5  |   | 360<br>6 / 6  |   |   |   |   |   |  |
| DC inrush sealed                         | W<br>W          | 120<br>2  |   | 230<br>4  |   | 230<br>5  |   | 230<br>4  |   | 350<br>5  |   | 360<br>6  |   |   |   |   |   |  |
| Switching time                           |                 |   |   |   |   |   |   |   |   |   |   |   |   |   |   |   |   |  |
| AC make time                             | ms              | 10 - 25   |   | 12 - 30   |   | 12 - 30   |   | 10 - 25   |   | 12 - 30   |   | 15 - 50   |   | 30 - 60   |   |   |   |  |
| AC release time                          | ms              | 6 - 18  |   | 6 - 15  |   | 6 - 15  |   | 6 - 18  |   | 6 - 15  |   | 30 - 80   |   | 30 - 80   |   |   |   |  |
| DC make time                             | ms              | 15 - 25   |   | 15 - 25   |   | 20 - 30   |   | 15 - 25   |   | 15 - 25   |   | 15 - 50   |   | 30 - 60   |   |   |   |  |
| DC release time                          | ms              | 40 - 70   |   | 10 - 25   |   | 10 - 25   |   | 40 - 70   |   | 10 - 25   |   | 30 - 80   |   | 30 - 80   |   |   |   |  |
| Maximum ambient temperature              |                 |   |   |   |   |   |   |   |   |   |   |   |   |   |   |   |   |  |
| Operation °C                             |                 | -40 to +40 (+70) <sup>2)</sup>  |   |   |   |   |   |   |   |   |   |   |   |   |   |   |   |  |
| Storage °C                               |                 | -40 to +70  |   |   |   |   |   |   |   |   |   |   |   |   |   |   |   |  |
| Short circuit protection for contactors  |                 |   |   |   |   |   |   |   |   |   |   |   |   |   |   |   |   |  |
| Coordination-type „1“ max. fuse size gPV |                 |   |   |   |   |   |   |   |   |   |   |   |   |   |   |   |   |  |
| 600VDC A                                 |                 | 63  | 80  | -   | -   | 160   | -   | -   | -   | -   | -   | 160   | 200   | 250   | -   | -   | -   |  |
| 1000VDC A                                |                 | -   | -   | -   | -   | -   | 12  | 63  | 100   | -   | 160   | 160   | 200   | 250   | 315   | 400   | 500   |  |
| Coordination-type „2“ max. fuse size gPV |                 |   |   |   |   |   |   |   |   |   |   |   |   |   |   |   |   |  |
| 600VDC A                                 |                 | 50  | 63  | 80  | 100   | 125   | -   | -   | -   | 100   | -   | -   | -   | -   | -   | -   | -   |  |
| 1000VDC A                                |                 | -   | -   | 80  | 100   | -   | -   | 50  | 80  | 100   | 125   | -   | -   | -   | -   | -   | -   |  |
| Short-circuit current                    | kA              | 3   | 3   | 3   | 3   | 5   | 3   | 3   | 3   | 5   | 5   | 10  | 10  | 10  | 10  | 10  | 10  |  |

Data according to UL60947-4-1 

| Type                    |             | <b>LISTED</b> | K3DC-20.. | K3DC-48.. | K3DC-60.. | K3DC-80.. | K3PV-80.. | K3PV-150.. | K3PV-200.. | K3PV-240.. | K3PV-300.. | K3PV-400.. | K3PV-450.. |
|-------------------------|-------------|---------------|-----------|-----------|-----------|-----------|-----------|------------|------------|------------|------------|------------|------------|
| General Use $I_e$ [A]   | 600V DC     |               | 20        | 40        | 60        | 80        | 80        | 130        | 160        | 200        | 300        | 330        | 360        |
|                         | 1000V DC    |               | -         | -         | 30        | 60        | 80        | 130        | 160        | 200        | 300        | 330        | 360        |
| Motor Control $I_e$ [A] | 220-240V DC |               | 12        | 20        | 38        | 55        | 72        | 89         | 106        | 140        | 173        | 206        | 255        |
|                         | 500V DC     |               | 12        | 16        | 34        | 51        | 67        | 83         | 99         | 123        | 164        | 205        | 246        |
|                         | 550-600V DC |               | 12        | 16        | 38        | 46        | 61        | 90         | 111        | 148        | 185        | 222        | 294        |

1) IP20 w. terminal lug.

2) > 40° ... 1% / C° de-rating (eg. at 60°C 20% de-rating)

# Dimensions

**K3DC-20A00, K3DC-48A00**

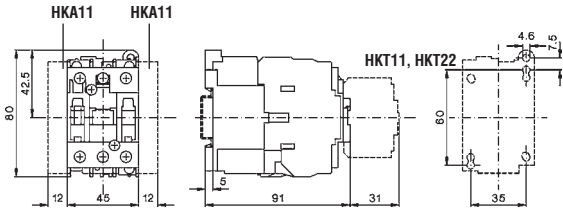

**K3DC-20A10=, K3DC-48A10=**

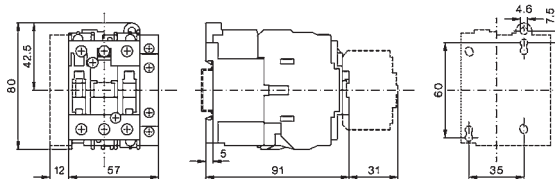

**K3DC-60A00(=), K3DC-80A00(=), K3DC-100A00(=)**

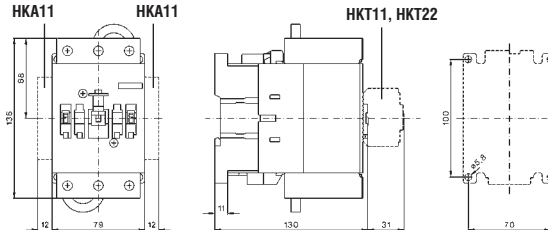
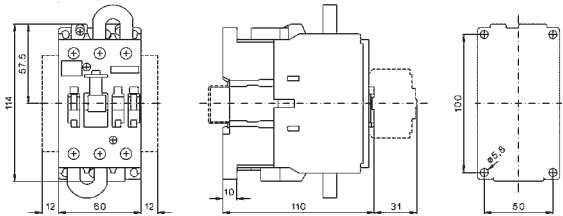

**K3PV-12A00**

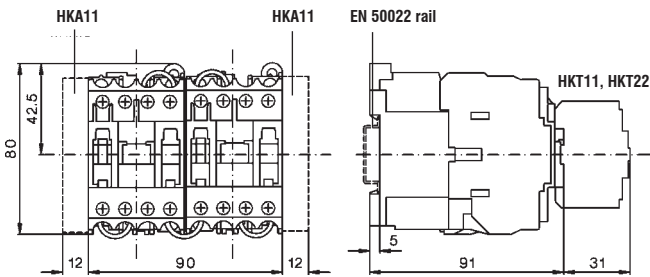

**K3PV-12A10=**

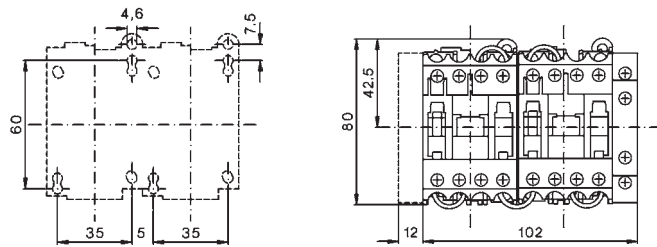

**K3PV-30A00, K3PV-60A00**

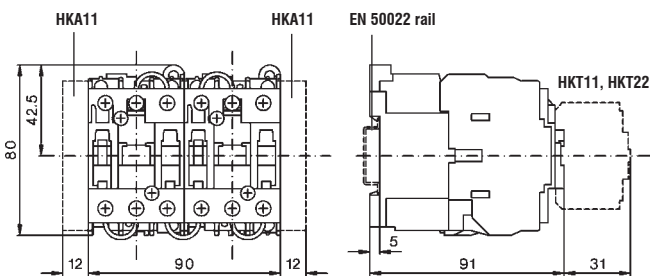

**K3PV-30A10=, K3PV-60A10=**

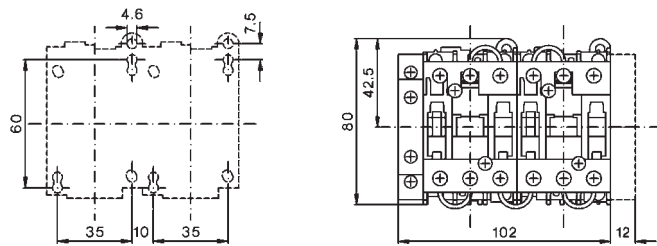

**K3PV-80A00(=)**

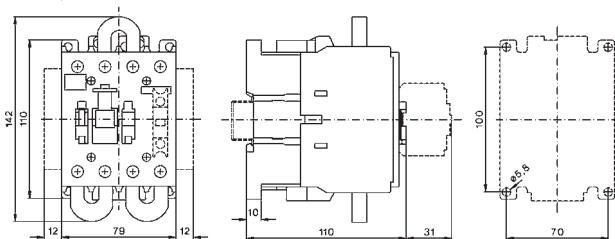

**K3PV-100A00(=)**

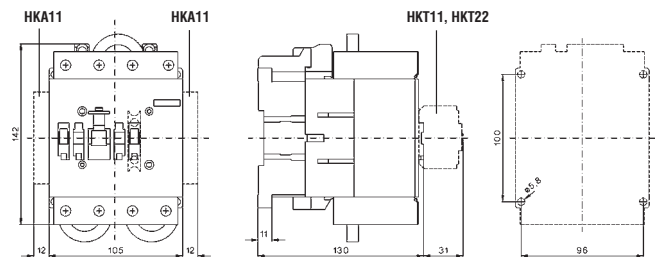

**K3PV-150A00(=), K3PV-200A00(=), K3PV-240A00(=)**

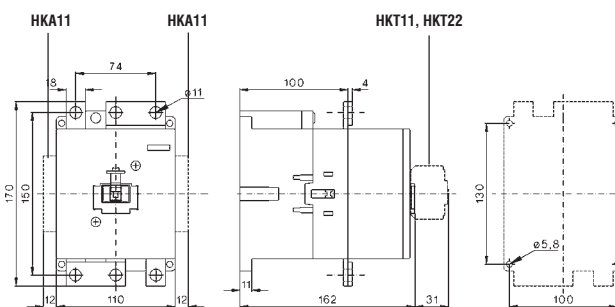

**K3PV-300A00(=), K3PV-400A00(=), K3PV-450A00(=)**

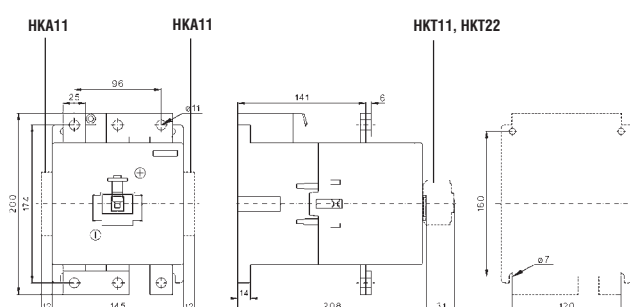

|  |  |                   |
|--|--|-------------------|
|  | <b>Contactors RAST 5</b><br>Contactor Relays<br>Contactors   | 147<br>147<br>147 |
|  | <b>Accessories</b><br>Auxilliary Contact Blocks  | 147<br>147        |
|  | <b>Combinations</b><br>Contactors for Fuseless Load Feeder<br>Contactors for Overload Relays             | 148<br>148<br>148 |
|  | <b>Industry Standard RAST 5</b><br>Contactor-Housing<br>Coil-Housing<br>Auxilliary Contact Block-Housing | 149<br>150<br>157 |
|  | <b>System Stocko RAST 5</b><br>Contactor-Housing<br>Coil-Housing<br>Auxilliary Contact Block-Housing     | 151<br>152<br>158 |
|  | <b>System Tyco RAST 5</b><br>Contactor-Housing<br>Coil-Housing<br>Auxilliary Contact Block-Housing       | 153<br>154<br>159 |
|  | <b>System Lumberg RAST 5</b><br>Contactor-Housing<br>Coil-Housing<br>Auxilliary Contact Block-Housing    | 155<br>156<br>160 |
|  | <b>Dimensions / Color Codes</b>  | 161               |
|  | <b>Technical Information</b>   | 162               |



# RAST 5 - exclusiv for OEM-Partner

5 mm pitch connector system

## Advantages RAST 5 - Technology

- Time saving installation
- Easy assembly without tools
- Tailor-made sockets, custom - designed codes
- Ambient temperatures up to +90°C/194°F
- Smallest sizes
- Plug technology up to 32 A / 415 V
- color coding for power ratings
- color coding for coil voltages

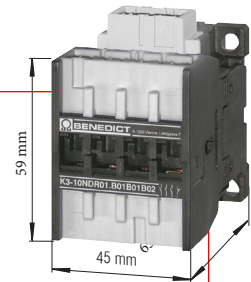

## RAST 5 - Accessories



Combining switchgears with plug-in connections and screw connections

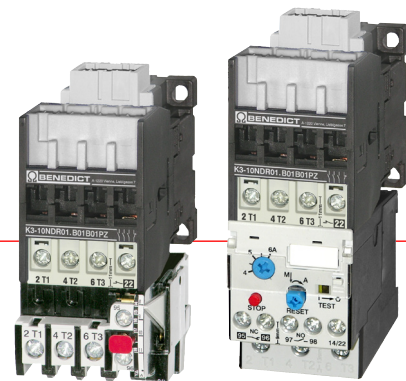

Contactors are available for plugs of many different producers

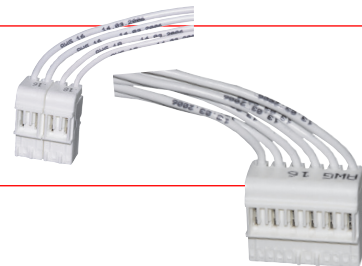

# Contactors, RAST 5





AC operated

| Ratings<br>AC2, AC3<br>380V<br>400V 220V<br>415V 230V<br><b>kW</b> kW kW |  |  | Rated-<br>Current<br>AC1<br>415V<br>A | Auxilliary<br>Contacts<br>built in<br>NO NC |  | Auxilliary<br>Contacts<br>snap on<br>HN10R.. | Type | Coil Voltage | Code Housing Coil | Code Housing IN (L) | Code Housing OUT (T) | Pack pcs. | Weight kg/pc. |
|--|--|--|---------------------------------------|---|--|--|------|--------------|-------------------|---------------------|----------------------|-----------|---------------|
|--|--|--|---------------------------------------|---|--|--|------|--------------|-------------------|---------------------|----------------------|-----------|---------------|

## ● Contactor Relays

|   |   |   |   |    |   |   |   |                   |  |  |  |   |      |
|---|---|---|---|----|---|---|---|-------------------|--|--|--|---|------|
|  | - | - | - | 10 | 4 | - | 2 | <b>K3-07NDR40</b> |  |  |  | 1 | 0,23 |
|   | - | - | - | 10 | 2 | 2 | 2 | <b>K3-07NDR22</b> |  |  |  | 1 | 0,23 |

## ● Contactors

|   |            |   |   |    |   |   |   |                   |  |  |  |   |      |
|---|------------|---|---|----|---|---|---|-------------------|--|--|--|---|------|
|    | <b>4</b>   | 3 | 3 | 25 | 1 | - | 2 | <b>K3-10NDR10</b> |  |  |  | 1 | 0,23 |
|   | <b>4</b>   | 3 | 3 | 25 | - | 1 | 2 | <b>K3-10NDR01</b> |  |  |  | 1 | 0,23 |
|    | <b>5,5</b> | 4 | 4 | 25 | 1 | - | 2 | <b>K3-14NDR10</b> |  |  |  | 1 | 0,23 |
|   | <b>5,5</b> | 4 | 4 | 25 | - | 1 | 2 | <b>K3-14NDR01</b> |  |  |  | 1 | 0,23 |
|  | <b>7,5</b> | 5 | 5 | 32 | 1 | - | 2 | <b>K3-18NDR10</b> |  |  |  | 1 | 0,23 |
|   | <b>7,5</b> | 5 | 5 | 32 | - | 1 | 2 | <b>K3-18NDR01</b> |  |  |  | 1 | 0,23 |
|  | <b>11</b>  | 6 | 7 | 32 | 1 | - | 2 | <b>K3-22NDR10</b> |  |  |  | 1 | 0,23 |
|   | <b>11</b>  | 6 | 7 | 32 | - | 1 | 2 | <b>K3-22NDR01</b> |  |  |  | 1 | 0,23 |

## Auxilliary

### ● Auxilliary Contact Blocks

| for Contactors  | AC15<br>230V<br>A | I <sub>th</sub><br>A | Contacts<br>NO NC |   | Type | Pack pcs.    | Weight kg/pc. |
|---|-------------------|----------------------|-------------------|---|------|--------------|---------------|
|  | K3-..R..          | 3                    | 10                | 1 | -    | <b>HN10R</b> | 10 0,02       |
|   | K3-..R..          | 3                    | 10                | - | 1    | <b>HN01R</b> | 10 0,02       |

Order Example for Contactors:

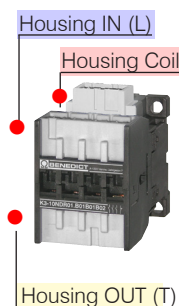
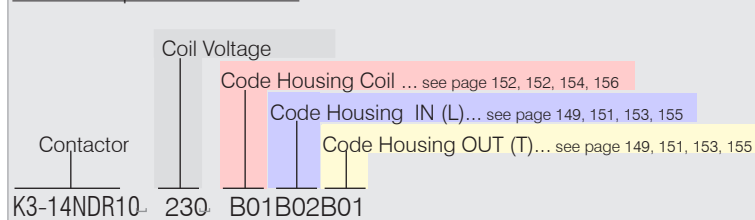

Technical data are subject to change without notice

# Contactors, RAST 5 Combinations

AC operated

Motor  
 AC2, AC3  
 380V AC3  
 400V 400V  
 415V 415V  
**kW A**





for  
 Overload Relays  
 U12/16E.. and U3/32...

## Type

Coil Voltage  
 Code Housing Coil  
 Code Housing IN (L)  
 Screw Connection OUT (T)

Pack Weight  
 pcs. kg/pcs.

● Contactors for Overload Relays

|  |     |    |  |                   |    |    |    |           |   |      |
|--|-----|----|--|-------------------|----|----|----|-----------|---|------|
|   | 4   | 10 | U12/16E 0,18-..23 K3 and U3/32 0,18-..32 | <b>K3-10NDR10</b> | .. | .. | .. | <b>PZ</b> | 1 | 0,23 |
|  | 4   | 10 | U12/16E 0,18-..23 K3 and U3/32 0,18-..32 | <b>K3-10NDR01</b> | .. | .. | .. | <b>PZ</b> | 1 | 0,23 |
|   | 5,5 | 14 | U12/16E 0,18-..23 K3 and U3/32 0,18-..32 | <b>K3-14NDR10</b> | .. | .. | .. | <b>PZ</b> | 1 | 0,23 |
|  | 5,5 | 14 | U12/16E 0,18-..23 K3 and U3/32 0,18-..32 | <b>K3-14NDR01</b> | .. | .. | .. | <b>PZ</b> | 1 | 0,23 |
|   | 7,5 | 18 | U12/16E 0,18-..23 K3 and U3/32 0,18-..32 | <b>K3-18NDR10</b> | .. | .. | .. | <b>PZ</b> | 1 | 0,23 |
|  | 7,5 | 18 | U12/16E 0,18-..23 K3 and U3/32 0,18-..32 | <b>K3-18NDR01</b> | .. | .. | .. | <b>PZ</b> | 1 | 0,23 |
|  | 11  | 22 | U12/16E 0,18-..23 K3 and U3/32 0,18-..32 | <b>K3-22NDR10</b> | .. | .. | .. | <b>PZ</b> | 1 | 0,23 |
|  | 11  | 22 | U12/16E 0,18-..23 K3 and U3/32 0,18-..32 | <b>K3-22NDR01</b> | .. | .. | .. | <b>PZ</b> | 1 | 0,23 |

Pozidriv ... PZ  
 Torx ..... TX

Selection of Contactor-Housings for Standard plugs acc. **Industry Standard RAST 5**



Contactor Housings

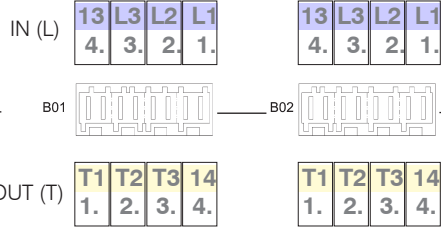

**Code Contactor-Housings** — B01 — B02 — B03 — B04 further housings on request →

**Standard plugs acc. Industry Standard RAST 5**



|                     |  |      |      |
|---------------------|--|------|------|
| 8-pole              |  |      |      |
| 6-pole left         |  |      |      |
| 6-pole right        |  |      |      |
| 4-pole left         |  | -0A- |      |
| 4-pole right        |  | -0B- |      |
| 2-pole left         |  |      |      |
|                     |  | -0I- | -0C- |
|                     |  | -0L- |      |
|                     |  |      |      |
|                     |  |      | -0A- |
|                     |  |      | -0Q- |
| 2-pole center left  |  | -0A- |      |
|                     |  | -0C- |      |
|                     |  |      |      |
|                     |  |      | -0K- |
|                     |  | -0O- |      |
|                     |  | -0Q- |      |
| 2-pole center right |  |      |      |
|                     |  |      | -0B- |
|                     |  | -0K- |      |
|                     |  |      |      |
|                     |  |      | -0F- |
|                     |  |      | -0L- |
| 2-pole right        |  |      |      |
|                     |  | -0B- |      |
|                     |  | -0F- |      |
|                     |  |      |      |
|                     |  |      | -0I- |
|                     |  | -0L- |      |
|                     |  | -0L- |      |

Order Example for Contactors:

Contactor — K3-14NR10  
 Coil Voltage — U<sub>230</sub>  
 Code Housing Coil ...see page 150, 152, 154, 156 — B01  
 Code Housing IN (L)... see page 149, 151, 153, 155 — B02  
 Code Housing OUT (T)...see page 149, 151, 153, 155 — B01

# Selection of Coil-Housings for Standard plugs acc. **Industry Standard RAST 5**



Coil-Housings

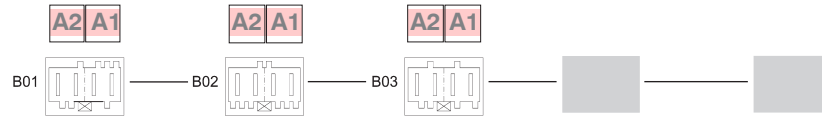

| Code Coil-Housings | B01  | B02  | B03  | B04 | B05 |
|--------------------|------|------|------|-----|-----|
| 4-pole             |      |      |      |     |     |
| 3-pole left        | -0B- | -0K- |      |     |     |
| 3-pole right       | -0C- | -0A- | -0H- |     |     |
| 2-pole center      |      | -0I- | -0B- |     |     |
|                    |      | -0C- | -0E- |     |     |
|                    | -0I- |      | -0L- |     |     |
|                    | -0L- |      | -0M- |     |     |
|                    |      | -0O- | -0P- |     |     |
|                    |      | -0Q- |      |     |     |

# Selection of Contactor-Housings for Standard plugs acc. **System Stocko RAST 5**



Contactor Housings

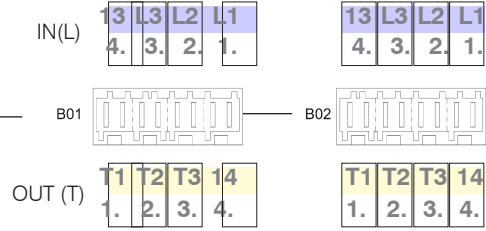

## Code Contactor-Housings — B01 — B02 — B03 — B04 further housings on request ▶

Standard plugs acc. System Stocko RAST 5



| Pole Configuration | B01                             | B02 | B03 | B04  |
|--------------------|---------------------------------|-----|-----|------|
| 8-pole             |                                 |     |     | -31- |
| 6-pole left        |                                 |     |     | -34- |
|                    |                                 |     |     | -35- |
|                    |                                 |     |     | -38- |
|                    |                                 |     |     | -50- |
|                    |                                 |     |     | -65- |
|                    |                                 |     |     | -1F- |
| 6-pole right       |                                 |     |     | -34- |
|                    |                                 |     |     | -35- |
|                    |                                 |     |     | -38- |
|                    |                                 |     |     | -50- |
|                    |                                 |     |     | -65- |
|                    |                                 |     |     | -1F- |
| 4-pole left        |                                 |     |     | -14- |
|                    |                                 |     |     | -16- |
|                    |                                 |     |     | -53- |
|                    |                                 |     |     | -60- |
|                    |                                 |     |     | -73- |
|                    |                                 |     |     | -75- |
| 4-pole right       |                                 |     |     | -10- |
|                    |                                 |     |     | -60- |
| 2-pole             | see... Industry Standard RAST 5 |     |     |      |

Order Example for Contactors:

Contactor                      Coil Voltage                      Code Housing Coil ...see page 150, 152, 154, 156  
 Code Housing IN (L)... see page 149, 151, 153, 155  
 Code Housing OUT (T)...see page 149, 151, 153, 155

K3-14NR10\_230\_B01 B02 B01

Selection of Coil-Housings for Standard plugs acc. **System Stocko RAST 5**



Coil-Housings –

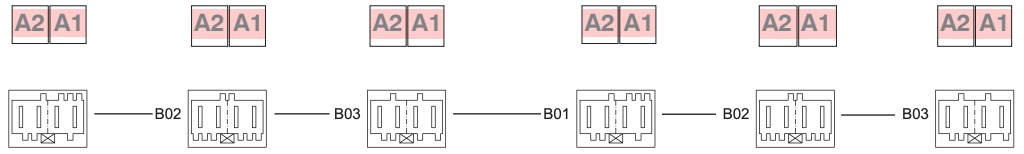

| Code Coil-Housings                             | B01    | B02  | B03  | B01  | B02  | B03  |
|--|--------|------|------|--|------|------|
| Standard plugs<br>acc.<br>System Stocko RAST 5 | 4-pole | -42- | -64- | 3-pole right                                     | -02- | -02- |
|  |        | -78- | -78- |  | -04- | -03- |
|  | -79-   |      | -78- |  |      | -18- |
| 3-pole left                                    |        |      | -79- |  |      |      |
|  |        |      | -01- | -19-   |      |      |
|  |        | -05- |      | -21-   |      |      |
|  |        | -12- |      |  |      | -28- |
|  |        | -16- |      | -47-   |      |      |
|  |        |      | -30- |  | -52- | -52- |
|  |        |      | -32- |  | -53- |      |
|  | -33-   |      |      |  | -66- | -64- |
|  | -36-   |      | -35- |  |      |      |
|  |        | -40- |      | -71-   |      | -73- |
|  |        |      | -44- |  | -74- |      |
|  |        |      | -48- |  | -75- | -75- |
|  | -49-   |      |      | 2-pole center<br>see... Industry Standard RAST 5 |      |      |
|  | -51-   |      |      |  |      |      |
|  | -72-   | -72- | -72- |  |      |      |
|  |        | -75- | -75- |  |      |      |

# Selection of Contactor-Housings for Standard plugs acc. **System Tyco RAST 5**



Contactor Housings

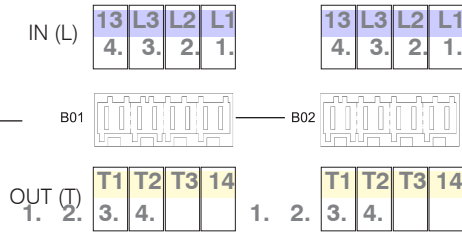

## Code Contactor-Housings — B01 — B02 — B03 — B04 further housings on request ▶

Standard plugs acc. System Tyco RAST 5



|                     | B01 | B02                      | B03 | B04  |
|---------------------|-----|--------------------------|-----|--|
| 8-pole              |     |                          |     |  |
| 6-pole left         |     | 928151-6<br>2-928344-6   |     |  |
| 6-pole right        |     |                          |     |  |
| 4-pole left         |     | 928344-4                 |     |  |
| 4-pole right        |     |                          |     | 4-928344-4                                       |
| 2-pole left         |     |                          |     | 928344-2<br>3-964951-2                           |
|                     |     | 2-964951-2<br>928343-2   |     |  |
|                     |     |                          |     | 964951-2<br>4-928344-2                           |
| 2-pole center left  |     | 928344-2                 |     |  |
|                     |     | 3-964951-2<br>4-928344-2 |     |  |
| 2-pole center right |     |                          |     | 2-928344-2<br>928343-2                           |
| 2-pole right        |     |                          |     | 2-928344-2<br>2-964951-2<br>928343-2<br>928343-2 |

Order Example for Contactors:

|           |              |  |  |  |
|-----------|--------------|--|--|--|
| Contactor | Coil Voltage | Code Housing Coil ...see page 150, 152, 154, 156 | Code Housing IN (L)... see page 149, 151, 153, 155 | Code Housing OUT (T)...see page 149, 151, 153, 155 |
| K3-14NR10 | 230          | B01  | B02  | B01  |









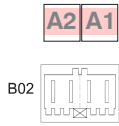



Selection of Coil-Housings for Standard plugs acc. **System Tyco RAST 5**



Coil  
Housings –



| Code Coil-Housings | B01  | B02  | B03   | B04 | B05 |
|--------------------|--|--|---|-----|-----|
| 4-pole             |  |  |   |     |     |
| 3-pole left        |  |  |   |     |     |
| 3-pole right       |  |  928344-3     |   |     |     |
| 2-pole center      |  |  928344-2     |  2-928344-2  |     |     |
|                    |  |  3-964951-2   |   |     |     |
|                    |  |  |  6-928344-2 |     |     |
|                    |  2-964951-2 |  |   |     |     |
|                    |  928343-2   |  |   |     |     |
|                    |  |  964951-2   |   |     |     |
|                    |  |  4-928344-2 |   |     |     |
|                    |  |  |  928343-2  |     |     |

Standard plugs  
acc.  
System Lumberg RAST 5



# Selection of Contactor-Housings for Standard plugs acc. **System Lumberg RAST 5**

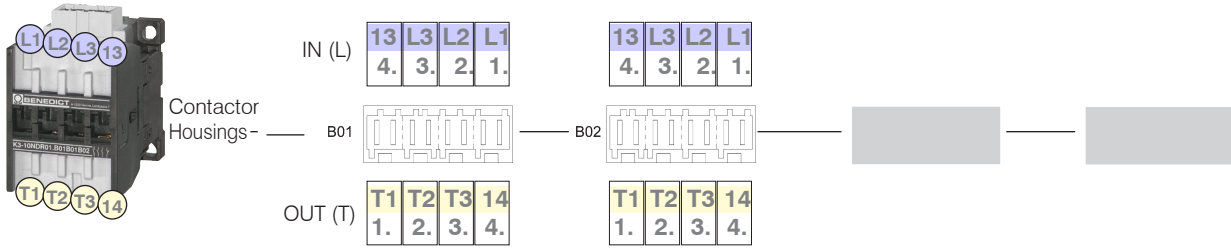

## Code Contactor-Housings B01 B02 B03 B04 further housings on request

Standard plugs acc. System Lumberg RAST 5



|                     | B01 | B02 | B03 | B04                  |
|---------------------|-----|-----|-----|----------------------|
| 8-pole              |     |     |     |                      |
| 6-pole left         |     |     |     | -10-                 |
| 6-pole right        |     |     |     |                      |
| 4-pole left         |     |     |     | -01-                 |
| 4-pole right        |     |     |     | -02-                 |
| 2-pole left         |     |     |     | -01-<br>-03-         |
| 2-pole center left  |     |     |     | -01-<br>-03-         |
| 2-pole center right |     |     |     | -10-<br>-02-<br>-06- |
| 2-pole right        |     |     |     | -02-<br>-06-<br>-09- |

Order Example for Contactors:

|  |           |
|--|-----------|
| Contactor  | K3-14NR10 |
| Coil Voltage                                       | 230       |
| Code Housing Coil ...see page 150, 152, 154, 156   | B01       |
| Code Housing IN (L)... see page 149, 151, 153, 155 | B02       |
| Code Housing OUT (T)...see page 149, 151, 153, 155 | B01       |

Selection of Coil-Housings for Standard plugs acc. **System Lumberg RAST 5**

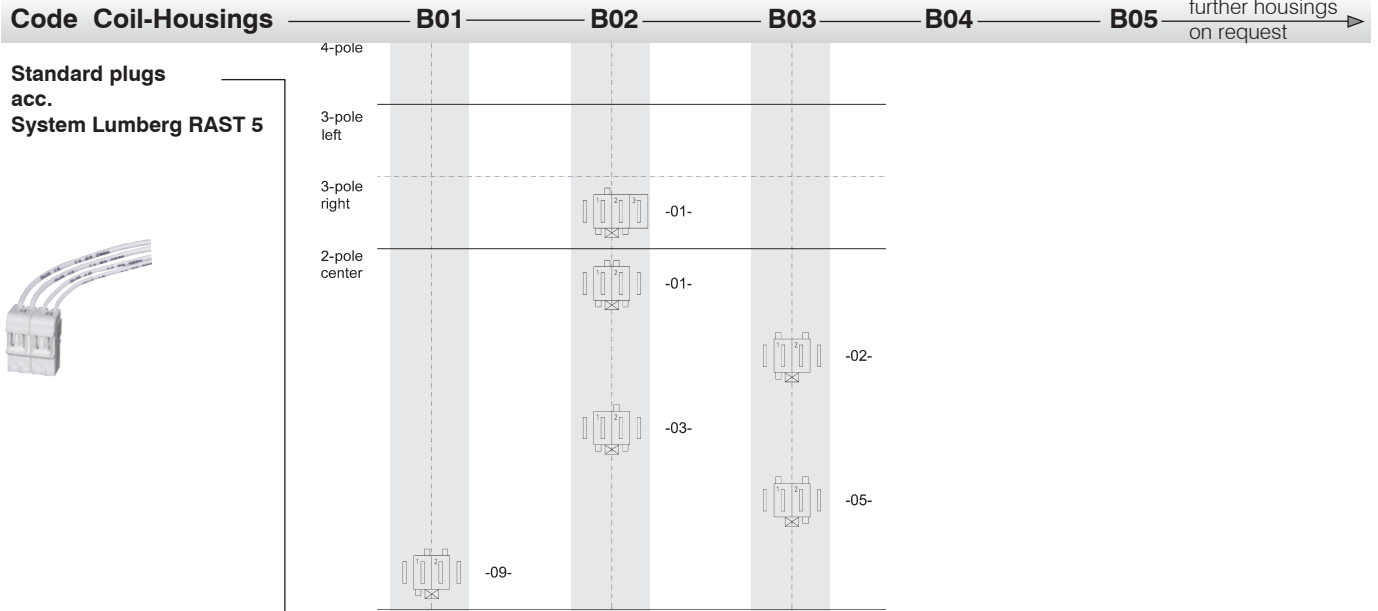
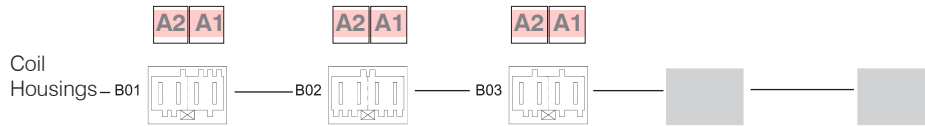

Selection of Auxiliary Contact Block-Housings for Standard plugs acc. **Industry Standard RAST 5**

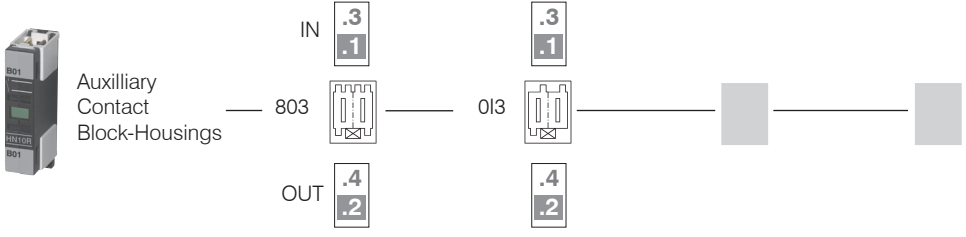

**Code Auxilliary-Contact Block-Housings**

Standard plugs acc. Industry Standard RAST 5

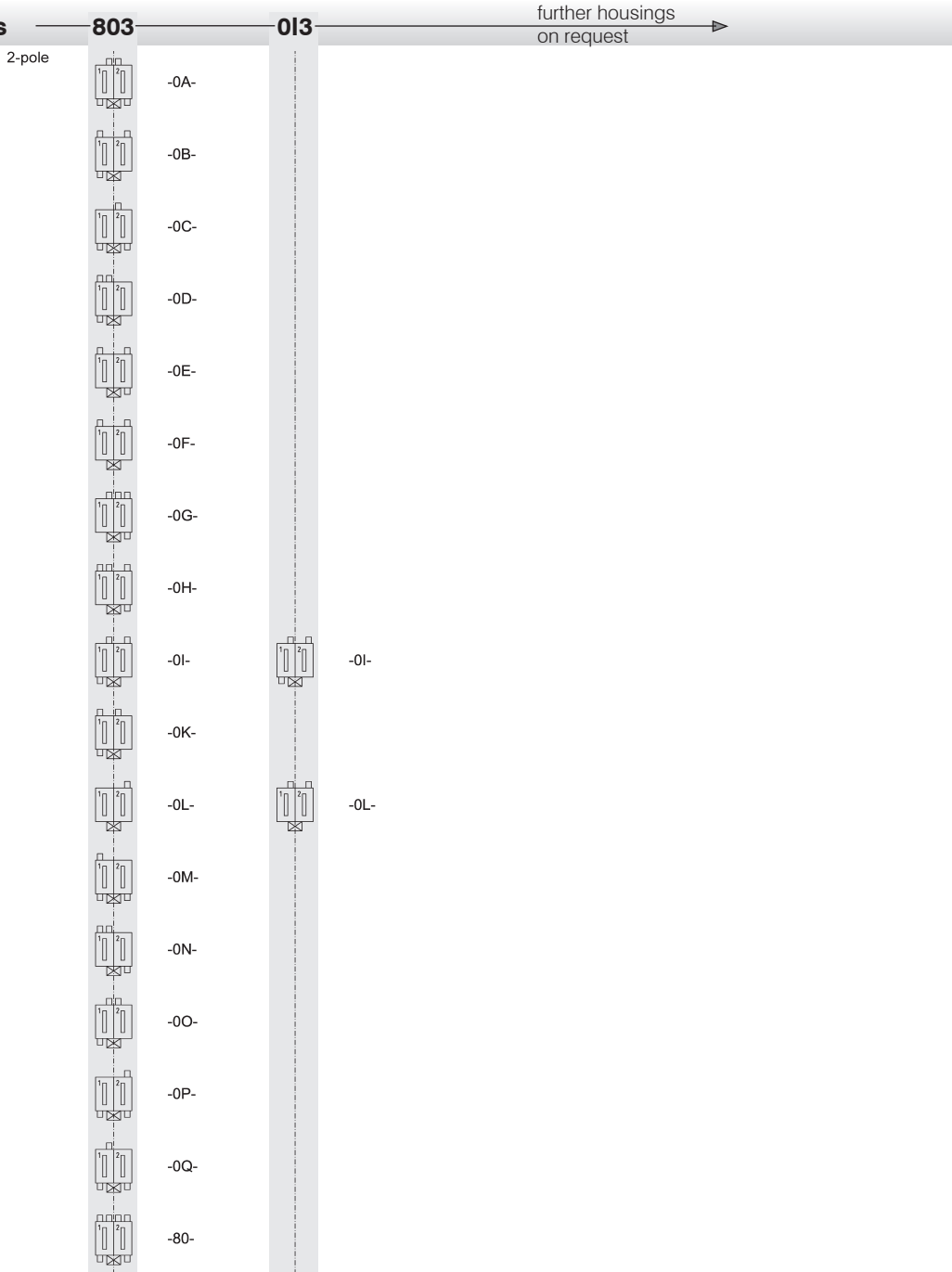

Order Example for Aux. Contact Blocks:

- Auxilliary Contact Block
  - Code Aux. Block Housing IN (1,3)
  - Code Aux. Block Housing OUT (2,4)
- HN10R-803013

Selection of Auxiliary Contact Block-Housings for Standard plugs acc. **System Stocko RAST 5**

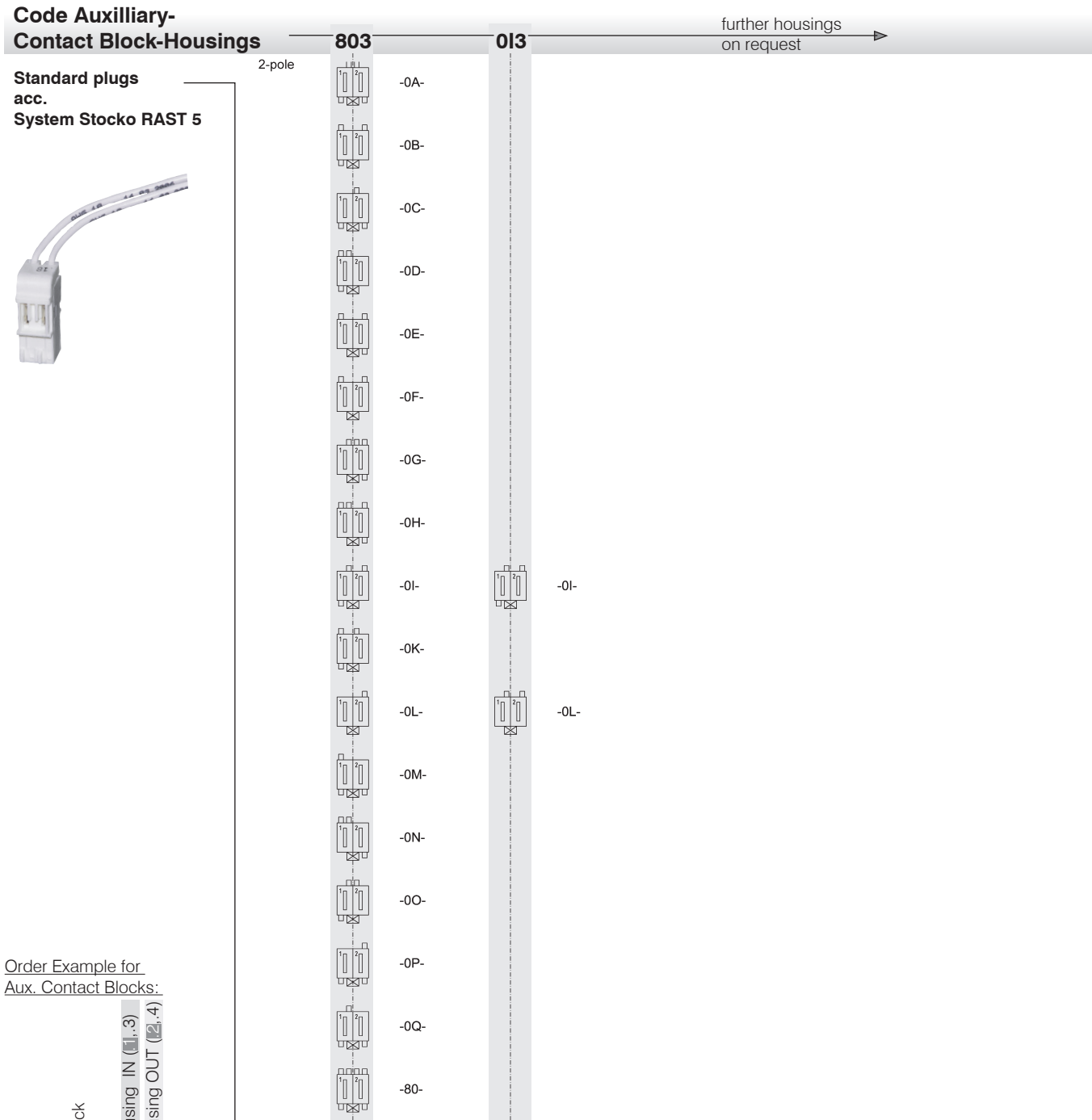
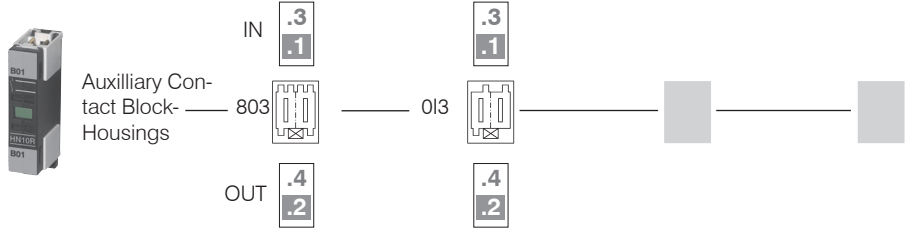

Order Example for  
Aux. Contact Blocks:

- Auxiliary Contact Block
- Code Aux. Block Housing IN (1,3)
- Code Aux. Block Housing OUT (2,4)

HN10R 803013

Selection of Auxiliary Contact Block-Housings for Standard plugs acc. **System Tyco RAST 5**

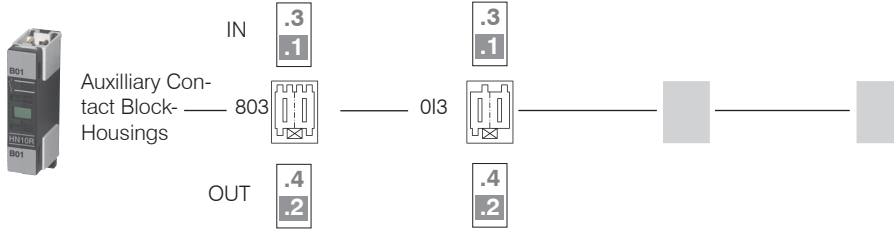

**Code Auxilliary-Contact Block-Housings**

**803**      **013**      further housings on request →

**Standard plugs acc. System Tyco RAST 5**



| 2-pole | 803        | 013        |
|--------|------------|------------|
|        | 928344-2   |            |
|        | 2-928344-2 |            |
|        | 3-964951-2 |            |
|        | 6-928344-2 |            |
|        | 5-928344-2 |            |
|        | 3-928344-2 |            |
|        | 2-964951-2 | 2-964951-2 |
|        | 928343-2   | 928343-2   |
|        | 964951-2   |            |
|        | 4-928344-2 |            |

Order Example for Aux. Contact Blocks:

HN10R-803013  
 -Auxiliary Contact Block  
 -Code Aux. Block Housing IN (1,3)  
 -Code Aux. Block Housing OUT (2,4)

Selection of Auxiliary Contact Block-Housings for Standard plugs acc. **System Lumberg RAST 5**

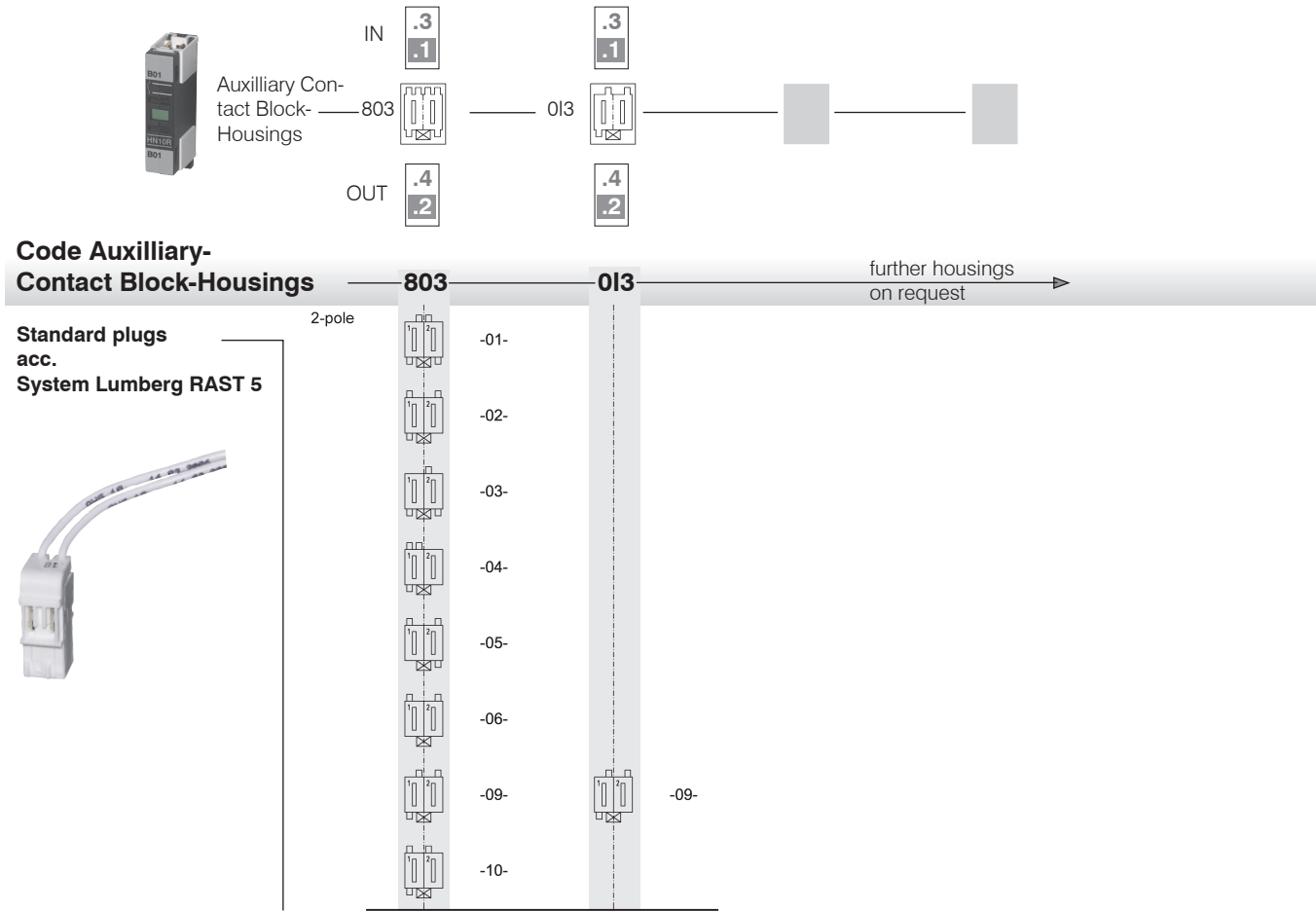

Order Example for  
Aux. Contact Blocks:

- Auxiliary Contact Block
- Code Aux. Block Housing IN (1,3)
- Code Aux. Block Housing OUT (2,4)

HN10R 803013

Data acc. to IEC 60947-4-1, VDE 0660

| Main Contacts  |   | Type            | K3-07NDR             | K3-10NDR             | K3-14NDR             | K3-18NDR             | K3-22NDR             |
|--|---|-----------------|----------------------|----------------------|----------------------|----------------------|----------------------|
| <b>Rated insulation voltage <math>U_i</math></b> <sup>1)</sup> |   | V~              | 415                  | 415                  | 415                  | 415                  | 415                  |
| <b>Making capacity <math>I_{eff}</math></b>                    | at $U_e = 415V\sim$                         | A               | -                    | 200                  | 200                  | 200                  | 200                  |
| <b>Breaking capacity <math>I_{eff}</math></b>                  | at $U_e = 415V\sim$<br>$\cos\varphi = 0,65$ | A               | -                    | 180                  | 180                  | 200                  | 200                  |
| <b>Utilization category AC1</b>                                |   |                 |                      |                      |                      |                      |                      |
| <b>Switching of resistive load</b>                             |   |                 |                      |                      |                      |                      |                      |
| Rated operational current $I_e (=I_{th})$                      | 415V  | <b>A</b>        | <b>10</b>            | <b>25</b>            | <b>25</b>            | <b>32</b>            | <b>32</b>            |
| Rated operation power  | 220V  | kW              | -                    | 9,5                  | 9,5                  | 12,2                 | 12,2                 |
| of three-phase resistive loads                                 | 230V  | kW              | -                    | 9,9                  | 9,9                  | 12,7                 | 12,7                 |
| 50-60Hz, $\cos\varphi = 1$                                     | 240V  | kW              | -                    | 10,4                 | 10,4                 | 13,3                 | 13,3                 |
|  | 380V  | kW              | -                    | 16,4                 | 16,4                 | 21,0                 | 21,0                 |
|  | 400V  | kW              | -                    | 17,3                 | 17,3                 | 22,1                 | 22,1                 |
|  | 415V  | kW              | -                    | 17,9                 | 17,9                 | 23,0                 | 23,0                 |
| Rated operational current $I_e (=I_{th})$                      | 415V  | A               | 6                    | 25                   | 25                   | 32                   | 32                   |
| at 60°C, enclosed  | 220V  | kW              | -                    | 9,5                  | 9,5                  | 12,2                 | 12,2                 |
| Rated operational power  | 230V  | kW              | -                    | 9,9                  | 9,9                  | 12,7                 | 12,7                 |
| of three-phase resistive loads                                 | 240V  | kW              | -                    | 10,4                 | 10,4                 | 13,3                 | 13,3                 |
| 50-60Hz, $\cos\varphi = 1$                                     | 380V  | kW              | -                    | 16,4                 | 16,4                 | 21,0                 | 21,0                 |
|  | 400V  | kW              | -                    | 17,3                 | 17,3                 | 22,1                 | 22,1                 |
|  | 415V  | kW              | -                    | 17,9                 | 17,9                 | 23,0                 | 23,0                 |
| Minimum cross-section of conductor                             |   | mm <sup>2</sup> | 2 x 1,5 <sup>2</sup> | 2 x 1,5 <sup>2</sup> | 2 x 1,5 <sup>2</sup> | 2 x 2,5 <sup>2</sup> | 2 x 2,5 <sup>2</sup> |
| at load with $I_e (=I_{th})$                                   |   |                 |                      |                      |                      |                      |                      |
| <b>Utilization category AC2 and AC3</b>                        |   |                 |                      |                      |                      |                      |                      |
| <b>Switching of three-phase motors</b>                         |   |                 |                      |                      |                      |                      |                      |
| Rated operational current $I_e$                                | 220V  | A               | -                    | 12                   | 15                   | 18                   | 22                   |
| open and enclosed  | 230V  | A               | -                    | 11,5                 | 14,5                 | 18                   | 22                   |
|  | 240V  | A               | -                    | 11                   | 14                   | 18                   | 22                   |
|  | <b>380-400V</b>                             | <b>A</b>        | <b>-</b>             | <b>10</b>            | <b>14</b>            | <b>18</b>            | <b>22</b>            |
|  | 415V  | A               | -                    | 9                    | 14                   | 18                   | 22                   |
| Rated operational power  | 220-230V                                    | kW              | -                    | 3                    | 4                    | 5                    | 6                    |
| of three-phase motors  | 240V  | kW              | -                    | 3                    | 4                    | 5                    | 7                    |
| 50-60Hz  | <b>380-400V</b>                             | <b>kW</b>       | <b>-</b>             | <b>4</b>             | <b>5,5</b>           | <b>7,5</b>           | <b>11</b>            |
|  | 415V  | kW              | -                    | 4,5                  | 6                    | 8,5                  | 12                   |
| <b>Auxilliary Contacts</b>                                     |   |                 |                      |                      |                      |                      |                      |
| <b>Rated insulation voltage <math>U_i</math></b>               |   | V~              | 415                  | 415                  | 415                  | 415                  | 415                  |
| <b>Thermal rated current <math>I_{th}</math></b> up to 415V    |   |                 |                      |                      |                      |                      |                      |
| Ambient temperature  | 40°C  | A               | 10                   | 10                   | 10                   | 10                   | 10                   |
|  | 60°C  | A               | 6                    | 6                    | 6                    | 6                    | 6                    |
| <b>Utilization category AC15</b>                               |   |                 |                      |                      |                      |                      |                      |
| Rated operational current $I_e$                                | 220-240V                                    | A               | 3                    | 3                    | 3                    | 3                    | 3                    |
|  | 380-415V                                    | A               | 2                    | 2                    | 2                    | 2                    | 2                    |
| <b>Utilization category DC13</b>                               |   |                 |                      |                      |                      |                      |                      |
| Rated operational current $I_e$                                | 60V   | A               | 3,5                  | 3,5                  | 3,5                  | 3,5                  | 3,5                  |
|  | 110V  | A               | 0,5                  | 0,5                  | 0,5                  | 0,5                  | 0,5                  |
|  | 220V  | A               | 0,1                  | 0,1                  | 0,1                  | 0,1                  | 0,1                  |
| <b>Short circuit protection</b>                                | gL (gG)                                     | A               | 20                   | 20                   | 20                   | 20                   | 20                   |

1) Suitable for: earthed -neutral systems, overvoltage category I to III, pollution degree 3 (Industry-Standard):  $U_{imp} = 4kV$ .  
Data for other conditions on request.



Data acc. to IEC 60947-4-1, VDE 0660

| Main Contacts   |                             | Type                | K3-07NDR                          | K3-10NDR      | K3-14NDR | K3-18NDR | K3-22NDR |  |
|---|-----------------------------|---------------------|-----------------------------------|---------------|----------|----------|----------|--|
| <b>Maximum ambient temperature</b>  |                             |                     |                                   |               |          |          |          |  |
| Operation   | open                        | °C                  | -40 up to +60 (+90) <sup>1)</sup> |               |          |          |          |  |
|   | enclosed                    | °C                  | -40 up to +40                     |               |          |          |          |  |
|   | with thermal overload relay | open                | °C                                | -25 up to +60 |          |          |          |  |
|   |                             | enclosed            | °C                                | -25 up to +40 |          |          |          |  |
| Storage   | °C                          | -50 up to +90       |                                   |               |          |          |          |  |
| <b>Short circuit protection</b>   |                             |                     |                                   |               |          |          |          |  |
| for contactors without thermal overload relay   |                             |                     |                                   |               |          |          |          |  |
| Coordination-Type „1“ acc. to IEC 947-4-1,<br>Contact welding without hazard of persons   |                             |                     |                                   |               |          |          |          |  |
| max. fuse size  | gL (gG)                     | A                   | 20                                | 63            | 63       | 63       | 63       |  |
| Coordination-Type “2” acc. to IEC 947-4-1,<br>light Contact welding accepted  |                             |                     |                                   |               |          |          |          |  |
| max. fuse size  | gL (gG)                     | A                   |                                   | 25            | 35       | 35       | 35       |  |
| Contact welding not accepted  |                             |                     |                                   |               |          |          |          |  |
| max. fuse size  | gL (gG)                     | A                   |                                   | 16            | 16       | 16       | 16       |  |
| for Contactors with thermal overload relay the device with the smaller admissible backup fuse (contactor or thermal overload relay) determines the fuse size. |                             |                     |                                   |               |          |          |          |  |
| <b>Frequency of operations z</b>  |                             |                     |                                   |               |          |          |          |  |
| Contactors without thermal overload relay   |                             |                     |                                   |               |          |          |          |  |
|   | without load                | 1/h                 | 10000                             | 10000         | 10000    | 10000    | 10000    |  |
|   | AC3, I <sub>e</sub>         | 1/h                 |                                   | 600           | 600      | 600      | 600      |  |
|   | AC4, I <sub>e</sub>         | 1/h                 |                                   | 120           | 120      | 120      | 120      |  |
|   | DC3, I <sub>e</sub>         | 1/h                 |                                   | 600           | 600      | 600      | 600      |  |
| <b>Mechanical life</b>  |                             |                     |                                   |               |          |          |          |  |
| AC-operated   |                             | S x 10 <sup>6</sup> | 10                                | 10            | 10       | 10       | 10       |  |
| DC-operated   |                             | S x 10 <sup>6</sup> | 10                                | 10            | 10       | 10       | 10       |  |
| <b>Short time current</b>   | 10sec.-current              | A                   |                                   | 96            | 120      | 144      | 176      |  |
| <b>Power loss</b> per pole  | at I <sub>e</sub> /AC3 400V | W                   |                                   | 0,21          | 0,35     | 0,5      | 0,75     |  |
| <b>Resistance to shock acc. to IEC 68-2-27</b>  |                             |                     |                                   |               |          |          |          |  |
| Shock time 20ms sine-wave   | NO                          | g                   |                                   |               |          | 10       |          |  |
|   | NC                          | g                   |                                   |               |          | 6        |          |  |
| <b>Control Circuit</b>  |                             |                     |                                   |               |          |          |          |  |
| <b>Power consumption of coils</b>   |                             |                     |                                   |               |          |          |          |  |
| AC operated   | inrush                      | VA                  |                                   |               |          | 33-45    |          |  |
|   |                             | VA                  |                                   |               |          | 7-10     |          |  |
|   | sealed                      | W                   |                                   |               |          | 2,6-3    |          |  |
| DC operated   | inrush                      | W                   |                                   |               |          | 75       |          |  |
|   | sealed                      | W                   |                                   |               |          | 2        |          |  |
| <b>Operating range of coils</b>   |                             |                     |                                   |               |          |          |          |  |
| in multiples of control voltage U <sub>s</sub>  |                             |                     |                                   |               |          |          |          |  |
|   | AC operated                 |                     |                                   |               |          | 0,85-1,1 |          |  |
|   | DC operated                 |                     |                                   |               |          | 0,8-1,1  |          |  |
| <b>Switching time</b> at control voltage U <sub>s</sub> ± 10% <sup>2) 3)</sup>  |                             |                     |                                   |               |          |          |          |  |
| AC operated   | make time                   | ms                  |                                   |               |          | 8-16     |          |  |
|   | release time                | ms                  |                                   |               |          | 5-13     |          |  |
|   | arc duration                | ms                  |                                   |               |          | 10-15    |          |  |
| DC operated   | make time                   | ms                  |                                   |               |          | 8-12     |          |  |
|   | release time                | ms                  |                                   |               |          | 8-13     |          |  |
|   | arc duration                | ms                  |                                   |               |          | 10-15    |          |  |

1) With reduced control voltage range 0,9 bis 1,0 x U<sub>s</sub> and with reduced rated current I<sub>e</sub> /AC1 acc. to I<sub>e</sub> /AC3

2) Total breaking time = release time + arc duration

3) Values for delay of the release time of the make contact and the make time of the break contact will be increased, if magnet coils are protected with coil suppressor (Varistor, RC-Unit, Diode-Unit).

Data acc. to UL508

| Main Contacts (cULus)   |          | Type | K3-10NDR | K3-14NDR | K3-18NDR | K3-22NDR |
|---|----------|------|----------|----------|----------|----------|
| Bemessungsbetriebsstrom „General Use“                                     |          | A    | 25       | 25       | 30       | 30       |
| <b>Motor DOL 3-phase at 60Hz</b>  |          |      |          |          |          |          |
| Rated operational current   | 415V     | A    | 10       | 14       | 18       | 22       |
| Rated operational power   | 110-120V | hp   | 1½       | 2        | 2        | 3        |
|   | 200-208V | hp   | 3        | 3        | 5        | 5        |
|   | 220-240V | hp   | 3        | 3        | 5        | 5        |
|   | 265-277V | hp   | 3        | 5        | 7½       | 7½       |
|   | 380-415V | hp   | 5        | 5        | 10       | 10       |
| <b>Motor DOL 1-phase at 60Hz</b>  |          |      |          |          |          |          |
| Rated operational current   | 415V     | A    | 10       | 14       | 18       | 22       |
| Rated operational power of AC motor at 60Hz (1ph)                         | 110-120V | hp   | ½        | ¾        | 1        | 1½       |
|   | 200-208V | hp   | 1        | 1½       | 2        | 3        |
|   | 220-240V | hp   | 1½       | 2        | 3        | 3        |
|   | 265-277V | hp   | 2        | 3        | 3        | 3        |
|   | 380-415V | hp   | 3        | 3        | 5        | 5        |
| Fuses Suitable for use on a capability of delivering not more than (SCCR) |          | A    | 30       | 40       | 50       | 50       |
| rms   |          | A    | 5000     | 5000     | 5000     | 5000     |
|   |          | V    | 415      | 415      | 415      | 415      |
| Auxilliary Contacts (cULus)   |          |      | A300     | A300     | A300     | A300     |

## Accessories

Data acc. to IEC 60947-5-1, VDE 0660

| Auxilliary Contacts   |           | Type                | HN10R | HN01R |    |
|---|-----------|---------------------|-------|-------|----|
| <b>Rated insulation voltage <math>U_i</math></b>  |           | V~                  | 415   | 415   |    |
| <b>Thermal rated current <math>I_{th}</math></b> up to 415V<br>Ambient temperature                              | max. 40°C | A                   | 10    | 10    |    |
|   | max. 60°C | A                   | 6     | 6     |    |
| <b>Frequency of operations z</b>  |           | 1/h                 | 3000  | 3000  |    |
| <b>Mechanical life</b>  |           | S x 10 <sup>6</sup> | 10    | 10    |    |
| <b>Power loss</b> per pole at $I_e/AC1$   |           | W                   | 0,5   | 0,5   |    |
| <b>Utilization category AC15</b>  |           |                     |       |       |    |
| Rated operational betriebsstrom $I_e$   | 220-240V  | A                   | 3     | 3     |    |
|   | 380-415V  | A                   | 2     | 2     |    |
| <b>Utilization category DC13</b>  |           |                     |       |       |    |
| Bemessungs-<br>current $I_e$  | 60V       | A                   | 2     | 2     |    |
|   | 110V      | A                   | 0,4   | 0,4   |    |
|   | 220V      | A                   | 0,1   | 0,1   |    |
| <b>Short circuit protection</b><br>short circuit current 1kA,<br>contact welding not accepted<br>max. fuse size |           | gL (gG)             | A     | 20    | 20 |

Data acc. to UL508

|   |      |    |      |      |
|---|------|----|------|------|
| Rated operational current „General Use“ |      | A  | 10   | 10   |
| Rated operational voltage               | max. | V~ | 300  | 300  |
| <b>Auxiliary Contacts</b>               |      |    | A300 | A300 |

# Dimensions

## K3-..NDR.. +HN..R

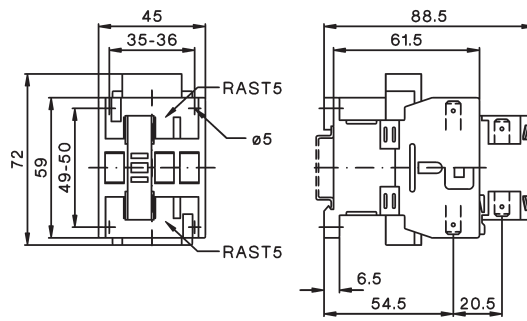

## K3-..NDR.....PZ + U3/32..

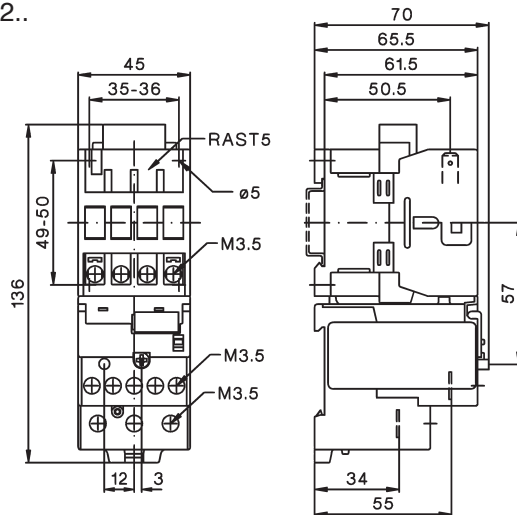

## K3-..NDR.....PZ + U12/16E..K3

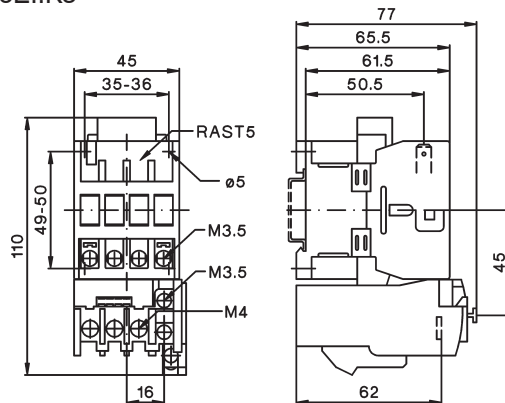

Technical data are subject to change without notice