

General Catalogue



Quality made in



D946E201

Index

Page



General

Approvals	4
Technical Information	5
Mounting Information	9
	10



Micro Contactors

	11
Micro Contactors	12
Micro Contactor Relays	14
Micro Reversing Contactors	18
Technical Information	20
Dimensions	24



Mini Contactors

	25
Mini Contactors	26
Interface Contactors	26
Mini Reversing Contactors	32
Technical Information	33
Dimensions	36



Contactor Relays

	39
Contactor Relays	40
Technical Information	40
Dimensions	44



Contactors

	45
Contactors Overview	46
Contactors, 3-pole	48
Contactors, 4-pole	50
Capacitor Switching Contactors	51
Accessories	52
Technical Information	62
Dimensions	82

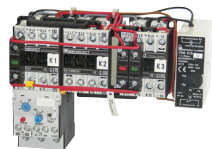

Starters

	91
Star-Delta Starters	92
Reversing Contactors	96
Pole Changing Starters	98
Technical Information	100
Dimensions	107



D.O.L. Starters

	111
D.O.L. Starters	112
Enclosures	113
Accessories	113
Technical Information	115
Dimensions	116



Overload Relays

	119
Thermal Overload Relays	121
Accessories	123
Technical Information	125
Dimensions	129



Modular Contactors

	133
Contactors	134
Accessories	135
Technical Information	138
Dimensions	140



Contactors for DC-Switching Contactors RAST 5

	141
	145

Contactor, Motor-Starters

Circuit Breakers

Manual Motor-Starters

Switches

AC-Main Switches

DC-Switch Disconnectors

Push Buttons

Representatives, Suppliers

General

Test Authorities, Registration Mark, Approvals

Low voltage switchgear from Benedict GmbH is built and tested to national and international specifications. All devices suit all important specifications without any test obligation, like VDE, BS and also relative to IEC Recommendations and to European Standards like IEC 947 and EN 60947. It is for this reason of our Low voltage switchgear is used all over the world. In order to provide special versions, limitations to the max. voltages, currents and power ratings or special markings are sometimes necessary.

Quality Control System

Since November 1991 Benedict GmbH has been certified according to the quality control system **ÖNORM EN ISO 29001**. The target of the ISO-certification is, to grant the customer the quality of the performance of his supplier, who is audited in accordance with this standard.

CE-Marking



The manufacturer has to sign his products with the CE-Marking. With the CE-Marking the manufacturer confirms the accordance with the different EEC Directives. The CE-Marking is absolutely necessary to sell the products in the EEC.

Below you find the EEC Directives concerning our products.

Low Voltage Directive 2006/95/EC

EMC Directive 2004/108/EC

RoHS + WEEE 2002/95/EC + "002/96/EC

Country	North America	Russia	China
State deputy or private examination (state admitted)	UL Canada, USA	EAC	CCC
Label marking of examination boards	Listed Component		
Duty of approvals	all switchgear	all switchgear	all switchgear

Explanations for choice and supply of low voltage switchgear in Canada and USA

Marking of auxiliary contacts

At several devices in UL-data are two voltages for auxiliary contacts mentioned (e. g.: 600 volts at same potential, 150 volts at different potentials). That means, if the voltage is higher than 150 volts, the control voltage applied to input terminals must be at the same potential.

Low voltage switchgear for auxiliary circuits (e. g. contactor relays, control units, auxiliary contacts in general) usually approved for "Heavy Duty" or "Standard Duty" UL and besides these marked with the admissible max. voltage or with short codes (see table).

Marking of auxiliary contacts according to CSA and UL	Max. rated values per pole			Cont. Current A	Contact Rating Code Designation
	Voltage V	Current Make A	Break A		
Heavy Duty (HD or HVY DTY)	AC 120	60	6	10	A150
	AC 240	30	3	10	A300
	AC 480	15	1,5	10	A600
	AC 600	12	1,2	10	A600
	DC 125	2,2	2,2	10	N150
	DC 250	1,1	1,1	10	N300
	DC 600	0,4	0,4	10	N600
Standard Duty (SD or STD DTY)	AC 120	30	3	5	B150
	AC 240	15	1,5	5	B300
	AC 480	7,5	0,75	5	B600
	AC 600	6	0,6	5	B600
	DC 125	1,1	1,1	5	P150
	DC 250	0,55	0,55	5	P300
	DC 600	0,2	0,2	5	P600
-	AC 120	15	1,5	2,5	C150
	AC 240	7,5	0,75	2,5	C300
	AC 480	3,75	0,375	2,5	C600
	AC 600	3	0,3	2,5	C600
	DC 125	0,55	0,55	2,5	Q150
	DC 250	0,27	0,27	2,5	Q300
	DC 600	0,1	0,1	2,5	Q600
-	AC 120	3,6	0,6	1	D150
	AC 240	1,8	0,3	1	D300
	DC 125	0,22	0,22	1	R150
	DC 250	0,11	0,11	1	R300
-	AC 120	1,8	0,3	0,5	E150

Discernment at UL-Standards

Recognized Component Industrial Control Equipment

UL issues yellow "Guide cards" with Guide- and File-No.

Devices have permission to be marked with on the label



Listed Industrial Control Equipment

UL issues white "Guide cards" with Guide- and File-No.

Devices have to be marked with the "UL-Listing Mark"



Devices as components approved for "factory wiring": devices for employment in control panels, when they are selected, mounted and wired according to the charging conditions by skilled worker.

Devices approved for "field wiring",







- a) devices for employment in control panels, when they are mounted and wired by skilled worker.
- b) devices for retail in USA

Valid UL-Standards:
UL 508 "Standard for Industrial Control Equipment" (partly limited)







Valid UL-Standards:
UL 508 "Standard for Industrial Control Equipment" (unlimited)

Are devices approved as "Listed Equipment" the approval is also valid for using as "Recognized Component" .

Approvals

Country	North America		Switzerland	Europe	Russia EAC	China	CENELEC CB-Certificates
Type	UL 		SEV 				
Micro Contactor Relays, Micro Contactors K0, Micro Reversing Contactors and Accessories							
K0-04D..	o	-	-	o	-	-	-
K0-05D..	o	-	-	o	-	o	-
K0W05D..	o	-	-	o	-	o	-
Mini Contactor Relays, Mini Contactors, Mini Reversing Contactors K1 and Accessories							
K1-07D..(=)	o	-	-	o	o	-	o
K1-07L..(=)	-	o	-	o	o	-	o
K1-07F..(=)	-	o	-	o	o	-	-
K1-09D..(=)	o	-	-	o	o	o	o
K1-09L..(=)	-	o	-	o	o	o	o
K1-09F..(=)	-	o	-	o	o	o	-
K1-12D..(=)	o	-	-	o	o	o	-
K1W09D01(=)	o	-	-	o	o	o	-
K1W12D01(=)	o	-	-	o	o	o	-
K1W09L01(=)	-	o	-	o	o	o	-
HK..., HKM..	o	-	-	o	o	-	o
RC-K1	o	-	-	o	o	-	-
Contactor Relays, Contactors Series K3							
K3-07ND..(=)	o	-	-	o	o	-	-
K3-10N..(=)	o	-	o	o	o	o	o
K3-14N..(=)	o	-	o	o	o	o	o
K3-18N..(=)	o	-	o	o	o	o	o
K3-22N..(=)	o	-	o	o	o	o	o
K3-24A..(=)	o	-	o	o	o	o	o
K3-32A..(=)	o	-	o	o	o	o	o
K3-40A..(=)	o	-	o	o	o	o	o
K3-50A..(=)	o	-	o	o	o	o	o
K3-62A..(=)	o	-	o	o	o	o	o
K3-74A..(=)	o	-	o	o	o	o	o
K3-90A..(=)	o	-	-	o	o	o	-
K3-115A..(=)	o	-	-	o	o	o	-
K3-151A..(=)	o	-	-	o	o	-	-
K3-176A..(=)	o	-	-	o	o	-	-
K3-210A..(=)	x	-	-	o	o	-	-
K3-260A..(=)	x	-	-	o	o	-	-
K3-316A..(=)	x	-	-	o	o	-	-
K3-450A..(=)	o	-	-	o	o	-	-
K3-550A..(=)	o	-	-	o	o	-	-
K3-700A..(=)	o	-	-	o	o	-	-
K3-860A..(=)	o	-	-	o	o	-	-
K3-1000A..(=)	-	-	-	o	o	-	-
K3-1200A..(=)	o	-	-	o	o	-	-
Contactor Relays, Contactors DC operated Series KG3							
KG3-07..	o	-	-	o	o	-	o
KG3-10..., -14..	o	-	-	o	o	-	o
KG3-18..., -22..	o	-	-	o	o	-	o
KG3-24..., -32..	o	-	-	o	o	-	o
KG3-40..	o	-	-	o	o	-	o
Capacitor Contactors Series K3							
K3-18K..	o	-	-	o	o	o	o
K3-24K..	o	-	-	o	o	o	o
K3-32K..	o	-	-	o	o	o	o
K3-50K..	o	-	-	o	o	o	o
K3-62K..	o	-	-	o	o	o	o
K3-74K..	o	-	-	o	o	o	o
K3-90K..	o	-	-	o	o	o	-
K3-115K..	o	-	-	o	o	o	-
Aux. Contacts							
HN..., HTN..	o	-	-	o	o	o	o
HA..	o	-	-	o	o	-	o
HB..	o	-	-	o	o	o	o
K2-DK, K2-SK	o	-	-	o	o	-	-
HKA..., HKT..	o	-	-	o	o	-	-
HKF22	-	-	-	o	o	-	-
o approved in standard version x pending - not provided to be tested							

Approvals

Country	North America		Switzerland	Europe	Russia EAC	China	CENELEC CB-Certificates
Typ	UL		SEV				
							
Accessories							
K2-T.E, -A	-	-	-	0	0	-	-
K2-TP	0	-	-	0	0	-	-
K2-L	0	-	-	0	0	-	-
K2-IN.	0	-	-	0	0	-	-
K2-UN.	0	-	-	0	0	-	-
K2-IM	-	-	-	0	0	-	-
K2-E	0	-	-	0	0	-	-
VG-K2	-	-	-	0	0	-	-
RC-K3	0	-	-	0	0	-	-
Reversing Contactors Series K3NWU							
K3NWU-10	0	-	-	0	0	-	-
K3NWU-14	0	-	-	0	0	-	-
K3NWU-18	0	-	-	0	0	-	-
K3NWU-22	0	-	-	0	0	-	-
K3WU-24	0	-	-	0	0	-	-
K3WU-32	0	-	-	0	0	-	-
K3WU-40	0	-	-	0	0	-	-
D.O.L Starters							
P1..	0	-	-	0	0	-	-
Thermal Overload Relays							
U3/32	0	-	-	0	0	-	0
U3/42	0	-	-	0	0	-	0
U3/74	0	-	-	0	0	-	0
U12/16E	0	-	-	0	0	-	0
U12/16A	-	-	-	0	0	-	0
U12/16EM	-	-	-	0	0	-	0
U12/16EQ	-	-	-	0	0	-	0
U32	0	-	-	0	0	-	0
U60	0	-	-	0	0	-	0
U85	0	-	-	0	0	-	0
U180	x	-	-	0	0	-	-
U320	x	-	-	0	0	-	-
U800	-	-	-	0	0	-	-
Modular Contactors							
R20	0	-	0	0	0	-	0
R25	0	-	0	0	0	-	0
R40	0	-	0	0	0	-	0
R63	0	-	0	0	0	-	0
R40, R63 2-polig	-	-	-	0	0	-	0
RH11	0	-	-	0	0	-	0
Push Buttons							
B(C,K,S)3/4/5D	0	-	-	0	0	-	0
Contactors Relays and Contactors Series K3 (RAST 5)							
K3-10/14/18/22NR	0	-	-	0	0	0	0
Contactors for DC-Loads							
K3DC-20 bis 80	0	-	-	0	0	-	0
K3DC-100	-	-	-	0	0	-	0
K3PV-30 bis 60	-	-	-	0	0	-	0
K3PV-80	0	-	-	0	0	-	0
K3PV-100	-	-	-	0	0	-	0
K3PV-150 bis 450	0	-	-	0	0	-	0
Main Contactors Series K3							
K3-10/14/18/22NBD	-	-	-	0	0	-	0

o approved in standard version

x pending

- not provided to be tested

Approvals

Country	North America		Switzerland	Europe	Russia EAC	China	CENELEC CB-Certificates
Typ	UL		SEV	CE	EAC	CCC	
							

Motor Protection Circuit Breakers Series M4-..

M4-32T	o	-	-	o	o	-	-
M4-32R	o	-	-	o	o	-	-
M4-63R	o	-	-	o	o	-	-
M4-100R	o	-	-	o	o	-	-

Zubehör

M4 HQ	o	-	-	o	o	-	-
M4 HS	o	-	-	o	o	-	-
M4 MA	o	-	-	o	o	-	-
M4 M	o	-	-	o	o	-	-
M4 U	o	-	-	o	o	-	-
M4 A	o	-	-	o	o	-	-

Motor Protection Circuit Breakers Series MU25A-..

MU25A	o	-	-	o	-	-	-
-------	---	---	---	---	---	---	---

Accessories

MU25A-PS	o	-	-	o	-	-	-
MU25A-PV	o	-	-	o	-	-	-
MU25A-A	o	-	-	o	-	-	-
MU25A-U	o	-	-	o	-	-	-

Mini DC-Isolators

LSM(O)16/25/32/38	o	-	-	-	o	-	-
-------------------	---	---	---	---	---	---	---

DC-Switch Disconnectors, 2, 2+2, 4 pole

LS16/20/25/32	o	-	-	o	o	o	o
LS40/55/65	o	-	-	o	o	o	o

DC-Switch Disconnectors, 3+2, 4+2, 6, 8 pole

LS16/20/25/32	o	-	-	o	o	o	-
LS40/55/65	o	-	-	o	o	o	-

AC-Main Switches

LTS20/25/32/40	o	-	-	o	o	-	o
LTS63/80	o	-	-	o	o	-	o
LTS85/100/125	o	-	-	o	o	-	o

AC-Cam Switches

M4H	o	-	-	o	o	-	o
M10	o	-	-	o	o	-	o
M10H(D)	o	-	-	o	o	-	o
M20	o	-	-	o	o	-	o
N33F	o	-	-	o	o	-	o
N40	o	-	-	o	o	-	o
N60	o	-	-	o	o	-	o
N61	o	-	-	o	o	-	o
N80	o	-	-	o	o	-	o
N100	o	-	-	o	o	-	o
N200	o	-	-	o	o	-	o
L400	o	-	-	o	o	-	o

o approved in standard version

x pending

- not provided to be tested

cUL^{us} - and cRU^{us} - Guide- and File-No.

These data are important for UL-inspectors.
Devices

Devices	Guide-No.				File-No.
	cUL ^{us}		cRU ^{us}		
	Canada	USA	Canada	USA	
Contactors	NLDX7	NLDX	NLDX8	NLDX2	E41502
Revering Contactors	NLDX7	NLDX	-	-	E41502
Contactors Relays, Accessories	NKCR7	NKCR	NKCR8	NKCR2	E66273
Thermal Overload Relays	NKCR7	NKCR	-	-	E66273
Cam Switches	NLRV7	NLRV	-	-	E129916
Circuit Breakers as Manual Motor Controller	NLRV7	NLRV	-	-	E129916
Circuit Breakers as Combination Motor Controller	NKJH7	NKJH	-	-	E197641
Bus Bar Assemblies	NLRV7	NLRV	-	-	E129916
Accessories for Circuit Breakers	NKCR7	NKCR	-	-	E66273

Technical Information

Degree of protection acc. to IEC 60947-1

Protection ratings are prefixed by the internationally agreed letters IP followed by two digits.

1st digit: Pertains to solid objects
2nd digit: Pertains to water.

1 st digit	Short description	Definition
1	Protected against solid objects greater than 50 mm	Excludes solid objects exceeding 50 mm in diameter and protects against contact with live and moving parts by a large body surface such as a hand (but not against deliberate access).
2L	Protected against solid objects greater than 12,5 mm and against contact by standard test finger	Excludes solid objects exceeding 12,5 mm in diameter and protects against contact with live and moving parts by a standard test finger or similar objects not exceeding 80 mm in length.
3	Protected against solid objects	Excludes solid objects exceeding 2,5 mm in diameter or thickness, greater than 2,5mm
4	Protected against solid objects greater than 1 mm	Excludes solid objects exceeding 1 mm in diameter or thickness.
5	Dust protected	Prevents ingress of dust in quantities and locations that would interfere with the intended operation of the equipment.
6	Dust tight	Prevents ingress of dust.

Terminal markings acc. to EN50011

Auxiliary contacts of AC contactors and contacts of contactor relays and thermal overload relays are particularly marked. The terminal markings of normally-open contacts are printed as positive figures, they of normally-closed contacts as negative figures.

This gives a clear indication of the function of the contacts.

The figure below illustrates the determination of terminal markings for contactors with auxiliary contact blocks.

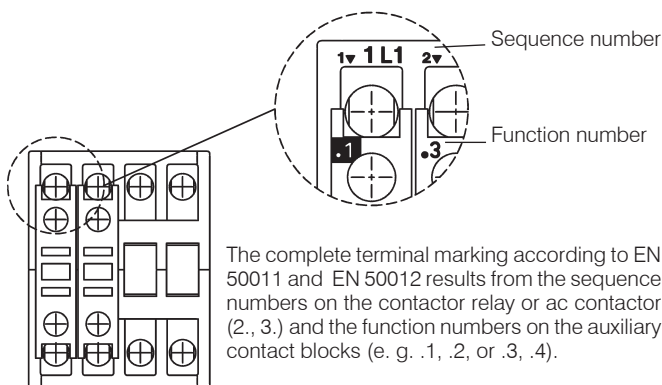

2 nd digit	Short description	Definition
1	Protected against dripping water	Dripping water (vertically falling drops) shall have no harmful effect.
2	Protected against dripping water when tilted up to 15°	Vertically dripping water shall have no harmful effect when the enclosure is tilted at any angle up to 15° from its normal position.
3	Protected against spraying water	Water falling as a spray at an angle up to 60° from the vertical shall have no harmful effect.
4	Protected against splashing water	Water splashed against the enclosure from any direction shall have no harmful effect.
5	Protected against water jets	Water protected by a nozzle against the enclosure from any direction shall have no harmful effect.
6	Protected against heavy seas	Water from heavy seas or water projected in powerful jets shall not enter the enclosure in harmful quantities.
7	Protected against the effects of immersion	Ingress of water in a harmful quantity shall not be possible when the enclosure is immersed in water under standard conditions of pressure and time.
8	Protected against submersion	No ingress of water.

Resistance to climatic conditions acc. to IEC60068

Open-type devices are climate-resistant in the constant climate according to IEC60068-2-78 (this is a climate with an ambient temperature of 40°C and an atmospheric humidity of 90 to 95%).

Enclosed devices are climate-resistant in an alternating climate according to IEC 68-2-30 (this is a moist alternating climate with a 24-hour cycle between climates with an ambient temperature of 25°C, and an atmospheric humidity of 95 to 100% and an ambient temperature of 40°C, and an atmospheric humidity of 90 to 96% in the presence of condensation during rises in temperature).

Data are valid up to an altitude of 2000m above sea level.

Short circuit protection

Back up fuses should be used to protect contactors and starters against short circuits. For starters the device with the smaller admissible fuse at the main and at the control circuit (contactor or thermal overload) determines the fuse size.

After a short circuit devices have to be checked for correct operation. Disconnect power before proceeding with any work on the equipment!

Technical Information

Mounting positions of contactors

K0-.. / K1-..

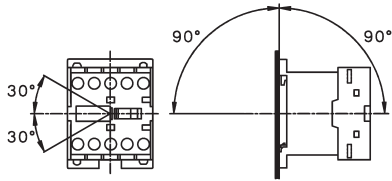

K(G)3-07.. to K3-115.., R20-.. to R63-..

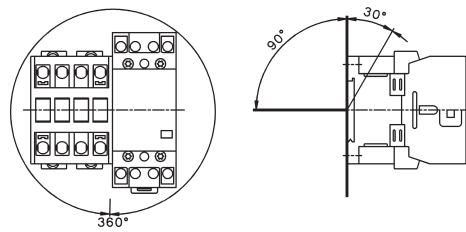



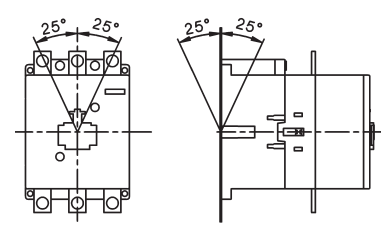



K3-151.. to K3-1200..
K3DC-20.. to K3DC-100..
K3PV-12.. to K3PV-450..



Terminal screws

Devices Type	Kind of connection			Screw driver	Tightening torque	
	Screw with washer	Screw with clamp box	Screw w. nut		Nm	lb. inch
Micro Contactors , all conductors K0-..	M2,5	-	-	Pz1	0,6 - 0,8	5 - 7
Mini Contactors , all conductors K1-..	M3,5	-	-	Pz2	0,8 - 1,4	7 - 12
Contactors Relays , all conductors K(G)3-07..	M3,5	-	-	Pz2	0,8 - 1,4	7 - 12
Contactors Main conductor						
K(G)3-10.. bis K3-22..	M3,5	-	-	Pz2	0,8 - 1,4	7 - 12
K(G)3-24.. bis K3-40..	-	M5	-	Pz2	2,5 - 3	22 - 26
K3-50.. bis K3-74..	-	M6	-	Pz3	3,5 - 4,5	31 - 40
K2-23, -30, -37A00-40 K2-45, -60A00-40	M4 -	- M6	- -	Pz2 Pz3	1,2 - 1,8 3,5 - 4,5	11 - 16 31 - 40
K3-90, K3-115	-	-	M8	4mm hex socket	4 - 6,5	35 - 57
K3-116.. bis K3-176.. K3-210.. bis K3-316.. K3-450.. bis K3-700.. K3-860.. K3-1000.., K3-1200..	- - - - -	- - - - -	M8 M10 M12 M14 M12		17 35 60 75 60	150 315 540 675 540
Auxiliary conductor K(G)3-10 bis K3-22	M3,5	-	-	Pz2	0,8 - 1,4	7 - 12
Coil conductor K(G)3-10 bis K3-1200	M3,5	-	-	Pz2	0,8 - 1,4	7 - 12
Accessories HK, HKM HA, HN, K2-..., HB..	M3,5 M3,5	- -	- -	Pz2 Pz2	0,8 - 1,4 0,8 - 1,4	7 - 12 7 - 12
Thermal Overload Relays Main conductor						
U12/16	M4	-	-	Pz2	1,2 - 1,8	11 - 16
U3/32 U3/42 U3/74	M3,5 M5 -	- - M6	- - -	Pz2 Pz2 Pz3	0,8 - 1,4 2,5 - 3 3,5 - 4,5	7 - 12 22 - 26 31 - 40
UAT21 UAT22 UAT23	- - -	M4 M4 M5	- - -	Size 3, 4 Size 3, 4 Size 3, 4, 5	1,2 - 1,8 1,2 - 1,8 2,5 - 3	11 - 16 11 - 16 22 - 26
Auxiliary conductor All devices	M3,5	-	-	Pz2	0,8 - 1,4	7 - 12
Contactors for Distribution Boards Conductors						
R20, R25 R40, R63 K1R	- - M3,5	M3,5 M5 -	- - -	Pz1 Pz2 Pz2	0,8 - 1,4 2,5 - 3 0,8 - 1,4	7 - 12 22 - 26 7 - 12
Coil conductor R20, R25 R40, R63 (2pole / 4 pole) K1R RH11	- - M3,5 -	M3 M3 - M3	- - - -	Pz1 Pz1 Pz2 Pz1	0,6 - 1,2 0,6 - 1,2 0,8 - 1,4 0,6 - 1,2	5 - 11 5 - 11 7 - 12 5 - 11

	<p>Micro Contactor Relays</p>	<p>12</p>
	<p>Micro Contactors</p>	<p>14</p>
	<p>Micro Contactors With Solder Pins</p> <p>Coil voltages</p>	<p>16</p> <p>16</p>
	<p>Micro Reversing Contactor</p>	<p>18</p>
	<p>Technical Data</p>	<p>20</p>
	<p>Dimensions</p>	<p>24</p>

Micro Contactor Relays 4-pole

AC Operated

Ratings Therm. **Contacts 2)** **Type** **Coil voltage 1)**
 Distinc. Additional **24** 24V 50/60Hz
 Number Contact **230** 220-240V 50Hz/60Hz

AC15 Rated  **Blocks**
230V 400V I_{th} A NO NC acc. to EN50011 Type ↓ Pack Weight
A A A NO NC EN50011 Type pcs. kg/pc.

4-pole, with Screw Terminals



Type	3	1,5	5	4	-	40E	-	K0-04D40 ...	10	0,07
	3	1,5	5	3	1	31E	-	K0-04D31 ...	10	0,07
	3	1,5	5	2	2	22E	-	K0-04D22 ...	10	0,07

K0-04D40

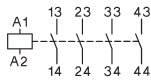

K0-04D31

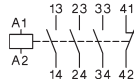

K0-04D22

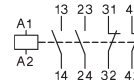

1) Other coil voltages on request.
 2) Contacts suitable for electronic circuits, according to EN947-5-4 for rated voltage 24V DC (test ratings 17V DC, 5mA). Mirror contacts acc. IEC60947-4-1 Annex F.

Micro Contactor Relays 4-pole

DC Operated

Ratings Therm.	Contacts ²⁾	Distinc. Number	Additional Contact	Type	Coil voltage ¹⁾	Pack pcs.	Weight kg/pc.
AC15	Rated Current				= 24		
230V A	400V A	I_{th} A	NO NC	acc. to EN50011	24V=DC		
				Blocks Type			



4-pole, with Screw Terminals

3	1,5	5	4	-	40E	-	K0-04D40= ...	10	0,09
3	1,5	5	3	1	31E	-	K0-04D31= ...	10	0,09
3	1,5	5	2	2	22E	-	K0-04D22= ...	10	0,09

K0-04D40

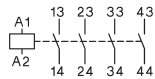

K0-04D31

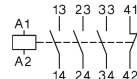

K0-04D22

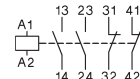

1) Other coil voltages on request.

2) Contacts suitable for electronic circuits, according to EN947-5-4 for rated voltage 24V DC (test ratings 17V DC, 5mA). Mirror contacts acc. IEC60947-4-1 Annex F.

Micro Contactors

AC Operated



Power Ratings	Rated Current	Aux. Contacts ²⁾		Type	Coil voltage ¹⁾	Pack pcs.	Weight kg/pc.
		Built-in	Additional				
AC2, AC3 380V 400V 415V kW	660V 690V A	AC1	NO NC	24 230	24V 50/60Hz 220-240V 50Hz/60Hz		
				↓			

3-pole, with Screw Terminals

2,2	-	12	1	-	-	K0-05D10 ...	10	0,07
-----	---	----	---	---	---	---------------------	----	------

2,2	-	12	-	1	-	K0-05D01 ...	10	0,07
-----	---	----	---	---	---	---------------------	----	------

4-pole, With Screw Terminals

2,2	-	12	-	-	-	K0-05D00-40 ...	10	0,07
-----	---	----	---	---	---	------------------------	----	------

K0-05D10

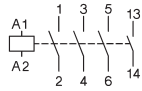

K0-05D01

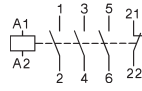

K0-05D00-40

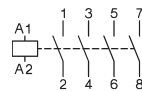

1) Other coil voltages see page 14.

2) Contacts suitable for electronic circuits, according to EN947-5-4 for rated voltage 24V DC (test ratings 17V DC, 5mA). Mirror contacts acc. IEC60947-4-1 Annex F.

Micro Contactors

DC Operated



Power Ratings	Rated Current	Aux. Contacts ²⁾		Type	Coil voltage ¹⁾ = 24 24V= DC	Pack pcs.	Weight kg/pc.
		Built-in	Additional				
AC2, AC3	AC1						
380V							
400V	660V						
415V	690V	440V					
kW	kW	A	NO NC	Blocks Type			

3-pole, with Screw Terminals

2,2	-	12	1	-	-	K0-05D10= ...	10	0,09
-----	---	----	---	---	---	----------------------	----	------

2,2	-	12	-	1	-	K0-05D01= ...	10	0,09
-----	---	----	---	---	---	----------------------	----	------

4-pole, With Screw Terminals

2,2	-	12	-	-	-	K0-05D00-40= ...	10	0,09
-----	---	----	---	---	---	-------------------------	----	------

K0-05D10

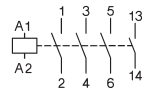

K0-05D01

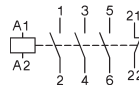

K0-05D00-40

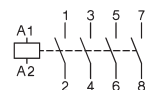

Snap-On Adapter

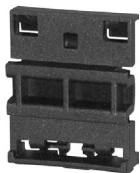

For Type	Specification	Type	Pack pcs..	Weight kg/pc.
K0	Snap on Adapter for K0	P1039	10	0,0061

for snap-on mounting of contactor K0 on 35mm DIN-rail acc. DIN EN 50022

1) Other coil voltages see page 14.

2) Contacts suitable for electronic circuits, according to EN947-5-4 for rated voltage 24V DC (test ratings 17V DC, 5mA). Mirror contacts acc. IEC60947-4-1 Annex F.

Contactor, Motor-Starters
Circuit Breakers
Manual Motor-Starters
Switches
AC-Main Switches
DC-Switch Disconnectors
Push Buttons
Representatives, Suppliers

Micro Contactors

AC Operated

Power Ratings	Rated Current	Aux. Contacts ²⁾		Type	Coil voltage ¹⁾	Pack pcs.	Weight kg/pc.
		Built in	Additional				
AC2, AC3	AC1				24V 50/60Hz		
380V					220-240V 50Hz/60Hz		
400V	660V						
415V	690V	440V					
kW	kW	A					



3-pole, with Solder Pins Ø1,15 for Printed Circuit Applications



2,2	-	9	1	-	-	K0-05L10 ...	10	0,07
-----	---	---	---	---	---	---------------------	----	------

2,2	-	9	-	1	-	K0-05L01 ...	10	0,07
-----	---	---	---	---	---	---------------------	----	------

4-pole, with Solder Pins Ø1,15 for Printed Circuit Applications

2,2	-	9	-	-	-	K0-05L00-40 ...	10	0,07
-----	---	---	---	---	---	------------------------	----	------

K0-05L10

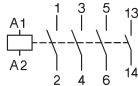

K0-05L01

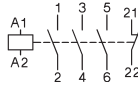

K0-05L00-40

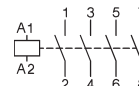

Coil voltages for AC operated contactors

Suffix to contactor type e.g. K0-05D10 24	Voltage Marking at the coil for		Rated Control Voltage U _s range for 50Hz				for 60Hz	
	50Hz	60Hz	min.	max.	min.	max.	min.	max.
	V	V	V	V	V	V	V	V
12	12	12	11	12	12	12		
24	24	24	22	24	24	24		
42	42	42	38,5	42	42	42		
48	48	48	48	50	48	52		
90	100	100	90	100	100	105		
95	95-100	105-110	95	100	105	110		
100	100	110-115	100	105	110	115		
105	105-110	115-120	105	110	115	120		
110	110-115	120-125	110	115	120	125		
180	200	200	185	200	200	210		

Suffix to contactor type e.g. K0-05D10 230	Voltage Marking at the coil for		Rated Control Voltage U _s range for 50Hz				for 60Hz	
	50Hz	60Hz	min.	max.	min.	max.	min.	max.
	V	V	V	V	V	V	V	V
200	200	200-220	195	205	200	220		
210	205-215	220-230	205	215	220	230		
220	210-220	220-240	210	220	220	240		
230	220-230	230-250	220	230	230	250		
240	230-240		230	240	250	260		

Standard voltages in bold type letters
Operating range of magnet-coils: 0,85 x U_s
(min. value of rated control voltage)
up to 1,1 x U_s
(max. value of rated control voltage)

Coil not exchangeable

1) Other coil voltages see page 14.

2) Contacts suitable for electronic circuits, according to EN947-5-4 for rated voltage 24V DC (test ratings 17V DC, 5mA). Mirror contacts acc. IEC60947-4-1 Annex F.

Micro Contactors

DC Operated

Power Ratings	Rated Current	Aux. Contacts ²⁾		Type	Coil voltage ¹⁾ = 24 24V= DC	Pack pcs.	Weight kg/pc.
		Built in	Additional				
AC2, AC3 380V 400V 415V kW	660V 690V kW	AC1 440V A					
			NO NC	Type			



3-pole, with Solder Pins Ø1,15 for Printed Circuit Applications

2,2	-	9	1	-	-	K0-05L10 ...	10	0,07
-----	---	---	---	---	---	---------------------	----	------

2,2	-	9	-	1	-	K0-05L01 ...	10	0,07
-----	---	---	---	---	---	---------------------	----	------

4-pole, with Solder Pins Ø1,15 for Printed Circuit Applications

2,2	-	9	-	-	-	K0-05L00-40 ...	10	0,07
-----	---	---	---	---	---	------------------------	----	------

K0-05L10

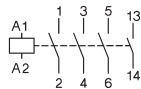

K0-05L01

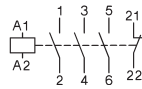

K0-05L00-40

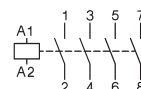

1) Other coil voltages see page 14.
2) Contacts suitable for electronic circuits, according to EN947-5-4 for rated voltage 24V DC (test ratings 17V DC, 5mA). Mirror contacts acc. IEC60947-4-1 Annex F.

Micro Reversing Contactors, Mechanical Interlocked

AC Operated

Power Ratings	Rated Current	Aux. Contacts ²⁾		Type	Coil voltage ¹⁾ 24V 50/60Hz 220-240V 50Hz/60Hz	Pack pcs.	Weight kg/pc.
		Built-in	Additional				
AC2, AC3	AC1		on left hand side Contactor	on right hand side Contactor			
380V							
400V	660V						
415V	690V	440V					
kW	kW	A	NO NC	K1 Type			

3-pole, with Screw Terminals



2,2	-	12	-	2	-	-	K0W05D01MC ...	1	0,14
-----	---	----	---	---	---	---	-----------------------	---	------

2,2	-	12	2	-	-	-	K0W05D10MC ...	1	0,14
-----	---	----	---	---	---	---	-----------------------	---	------

4-pole, with Screw Terminals



2,2	-	12	-	-	-	-	K0W05D00-40MC ...	1	0,14
-----	---	----	---	---	---	---	--------------------------	---	------

3-pole, with Solder Pins Ø1,15 for Printed Circuit Applications

2,2	-	xxx ³⁾	-	2	-	-	K0W05L01MC ...	1	0,14
-----	---	-------------------	---	---	---	---	-----------------------	---	------

2,2	-	xxx ³⁾	2	-	-	-	K0W05L10MC ...	1	0,14
-----	---	-------------------	---	---	---	---	-----------------------	---	------

K0W05D01MC

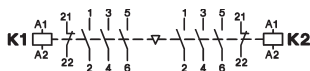

K0W05D10MC

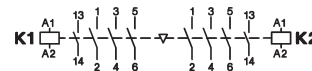

K0W05D00-40MC

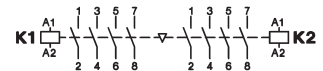

Reversing Starter Connector



For Reversing Starter Types, incl. Coil Connector

K0W05D..MC	K0W-VB	1	0,01
-------------------	---------------	---	------

1) Other coil voltages see page 14.

2) Contacts suitable for electronic circuits, according to EN947-5-4 for rated voltage 24V DC (test ratings 17V DC, 5mA). Mirror contacts acc. IEC60947-4-1 Annex F.

3) Data on request.

Micro Reversing Contactors, Mechanical Interlocked

DC Operated

Power Ratings	Rated Current	Aux. Contacts ²⁾		Type	Coil voltage ¹⁾ = 24 24V= DC	Pack pcs.	Weight kg/pc.
		Built-in	Additional				
AC2, AC3	AC1		on left hand side Contactor	on right hand side Contactor			
380V							
400V	660V						
415V	690V	440V					
kW	kW	A	NO NC	K1 Type			

3-pole, with Screw Terminals



2,2	-	12	-	2	-	-	K0W05D01MC ...	1	0,14
-----	---	----	---	---	---	---	-----------------------	---	------

2,2	-	12	2	-	-	-	K0W05D10MC ...	1	0,14
-----	---	----	---	---	---	---	-----------------------	---	------

4-pole, with Screw Terminals



2,2	-	12	-	-	-	-	K0W05D00-40MC ...	1	0,14
-----	---	----	---	---	---	---	--------------------------	---	------

3-pole, with Solder Pins Ø1,15 for Printed Circuit Applications

2,2	-	xxx ³⁾	-	2	-	-	K0W05L01MC ...	1	0,14
-----	---	-------------------	---	---	---	---	-----------------------	---	------

2,2	-	xxx ³⁾	2	-	-	-	K0W05L10MC ...	1	0,14
-----	---	-------------------	---	---	---	---	-----------------------	---	------

K0W05D01MC

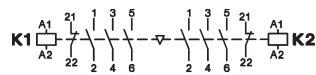

K0W05D10MC

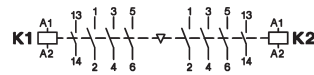

K0W05D00-40MC



1) Other coil voltages see page 14.
 2) Contacts suitable for electronic circuits, according to EN947-5-4 for rated voltage 24V DC (test ratings 17V DC, 5mA). Mirror contacts acc. IEC60947-4-1 Annex F.
 3) Data on request.

Micro Contactors

Data according to IEC 60947-4-1, VDE 0660, EN 60947-4-1

Main Contacts	Type	K0-05D..	K0-05L..
Rated insulation voltage U_i	V AC	440 ¹⁾	440 ¹⁾
Making capacity I_{eff} at $U_e = 440V$ AC	A	65	65
Breaking capacity I_{eff} $\cos\phi = 0,65$ 400V AC	A	50	50
Utilization category AC1			
Switching of resistive load			
Rated operational current $I_e (=I_{th})$ at 40°C, open	A	12	9
Rated operational power of three-phase resistive loads 50-60Hz, $\cos\phi = 1$	230V kW 240V kW 400V kW 415V kW 440V kW	4,7 4,8 8,3 8,6 9,0	3,5 3,7 3,3 6,4 6,8
Rated operational current $I_e (=I_{th})$ at 60°C, enclosed	A	8	6
Rated operational power of three-phase resistive loads 50-60Hz, $\cos\phi = 1$	230V kW 240V kW 400V kW 415V kW 440V kW	3,1 3,3 5,5 5,7 6,0	2,3 2,4 4,1 4,3 4,5
Minimum cross-section of conductor at load with $I_e (=I_{th})$	mm ²	1,5	-
Utilization category AC2 and AC3			
Switching of three-phase motors			
Rated operational current I_e open and enclosed	220V A 230V A 240V A	6,2 6,2 5,6	6,2 6,2 5,6
	380-400V A 415-440V A	5 5	5 5
Rated operational power of three-phase motors 50-60Hz	220-240V kW 380-440V kW	1,5 2,2	1,5 2,2
Utilization category AC4			
Switching of squirrel cage motors, inching			
Rated operational current I_e open and enclosed	220V A 230V A 240V A	4,9 4,9 4,1	4,9 4,9 4,1
	380-400V A 415-440V A	3,5 3,5	3,5 3,5
Rated operational power of three-phase motors 50-60Hz	220-240V kW 380-440V kW	1,1 1,5	1,1 1,5
Utilization category AC5a			
Switching of gas discharge lamps			
Rated operational current I_e per pole at 220/230V			
Fluorescent lamps, uncompensated and serial compensated	A	6	6
parallel compensated dual-connection	A A	0,5 9	0,5 9
Metal halide lamps ²⁾ , uncompensated	A	6	6
parallel compensated	A	0,5	0,5
Mercury-vapour lamps ³⁾ , uncompensated	A	9	9
parallel compensated	A	0,5	0,5
Mixed light lamps ⁴⁾	A	9	9
LED-Lamps			
consider the inrush current of the lamp ballast and $\cos\phi$ of the lamp	max. lamps per pole ($I_{nLED} \leq I_{th}$) =	$\frac{\text{inrush current of contactor}}{\text{inrush current of lamp/EVG}}$	
max inrush current of contactor	A	91	91
Utilization category AC5b			
Switching of incandescent lamps⁵⁾			
Rated operational current I_e per pole at 220/230V	A	3	3

1) Suitable for: earthed-neutral systems, overvoltage category I to III, pollution degree 3 (standard-industry): $U_{imp} = 4kV$.
Data for other conditions on request.

2) Metal halide lamps and sodium-vapour lamps (high- and low-pressure lamps)

3) High-pressure lamps

4) Blended lamps, containing a mercury high-pressure unit and a tungsten helix in a fluorescent glass bulb (daylight lamps)

5) Current inrush approx. 16 x I_e

Micro Contactors

Data according to IEC 60947-4-1, VDE 0660, EN 60947-4-1

Main Contacts			Type	K0-05D..	K0-05L..	
Utilization category DC1						
Switching of resistive load	1 pole	24V	A	12	9	
Time constant L/R ≤1ms		60V	A	12	9	
Rated operational current I _e		110V	A	2	2	
		180V	A	0,6	0,6	
		220V	A	0,4	0,4	
	3 poles in series	24V	A	12	9	
		60V	A	12	9	
		110V	A	12	9	
		180V	A	12	9	
		220V	A	8	8	
Utilization category DC3 and DC5						
Switching of shunt motors and series motors	1 pole	24V	A	12	9	
Time constant L/R ≤15ms		60V	A	4	4	
Rated operational current I _e		110V	A	1	1	
		180V	A	0,5	0,5	
		220V	A	0,3	0,3	
	3 Pole in Serie	24V	A	12	9	
		60V	A	12	9	
		110V	A	6	6	
		180V	A	4	4	
		220V	A	1	1	
Maximum ambient temperature						
Operation	open	°C		-40 to +60 (+90) ¹⁾		
	enclosed	°C		-40 to +40		
	with thermal overload relay	open	°C		-25 to +60	
		enclosed	°C		-25 to +40	
Storage		°C		-50 to +90		
Short circuit protection						
for contactors without thermal overload relay						
Coordination-type "1" according to IEC 947-4-1						
Contact welding without hazard of persons						
max. fuse size	gL (gG)	A		32	32	
Coordination-type "2" according to IEC 947-4-1						
Light contact welding accepted						
max. fuse size	gL (gG)	A		-	-	
Contact welding not accepted						
max. fuse size	gL (gG)	A		-	-	
For contactors with thermal overload relay the device with the smaller admissible backup fuse (contactor or thermal overload relay) determines the fuse size.						
Cable cross-sections						
for contactors						
main connector	solid or stranded	mm ²		0,5 - 1,5	Solder Connector Ø 1,15	
	flexible	mm ²		0,5 - 1,5		
	flexible with multicore cable end	mm ²		0,5 - 1,5		
Cables per clamp				2	-	
	solid or stranded	AWG		20 - 14	-	
Frequency of operation z						
contactors without thermal overload relay	without load	1/h		10000	10000	
	AC3, I _e	1/h		600	600	
	AC4, I _e	1/h		120	120	
	DC3, I _e	1/h		600	600	
Mechanical life						
	AC operated	S x10 ⁶		3	3	
	DC operated	S x10 ⁶		4	4	
Short time current						
	10s-current	A		50	50	
Power loss per pole						
	at I _e /AC3 400V	W		0,2	0,2	
Resistance to shock according to IEC 68-2-27						
Shock time 20ms sine-wave						
AC operated	NO	g		2,5	2,5	
	NC	g		2,5	2,5	

1) With reduced control voltage range 0,9 up to 1,0 x U_s and with reduced rated current I_e/AC1 according to I_e/AC3.

Micro Contactors

Data according to IEC 60947-5-1, VDE 0660, EN 60947-5-1

Auxiliary Contacts			Type	K0-04D.. K0-05D..	K0-04L.. K0-05L..
Rated insulation voltage	U_i	VAC		440 ¹⁾	440 ¹⁾
Thermal rated current I_{th} to 440V					
Ambient temperature	40°C	A		5	5
	60°C	A		3	3
Verlustleistung pro Pol	bei I _{th}	W		0,25	0,25
Utilization category AC15					
Rated operational current I _e	220-240V	A		3	3
	380-415V	A		1,5	1,5
	440V	A		1	1
Utilization category DC13					
Rated operational current I _e	24V	A		2	2
	60V	A		1,6	1,6
	110V	A		0,3	0,3
	180V	A		0,2	0,2
	220V	A		0,05	0,05
Maximum ambient temperature					
Operation	open	°C		-40 to +60 (+90) ²⁾	
	enclosed	°C		-40 to +40	
Storage		°C		-40 to +90	
Short circuit protection					
short-circuit current 1kA, contact welding not accepted max. fuse size			gL (gG) A	10	10
For contactors with thermal overload relay the device with the smaller admissible control fuse (contactor or thermal overload relay) determines the fuse size.					
Power consumption of coils					
AC operated	inrush	VA		9	9
	sealed	VA		4	4
		W		1,8	1,8
DC operated	inrush	W		2,5	2,5
	sealed	W		2,5	2,5
Operation range of coils					
in multiples of control voltage U _s		AC		0,85 - 1,1	0,85 - 1,1
		DC		0,8 - 1,1	0,8 - 1,1
Switching time at control voltage U _s ±10% ^{3) 4)}					
AC operated	make time	ms		13 - 18	13 - 18
	release time	ms		5 - 10	5 - 10
	arc duration	ms		10 - 15	10 - 15
DC operated	make time	ms		10 - 40	10 - 40
	release time	ms		2 - 10	2 - 10
	arc duration	ms		10 - 15	10 - 15
Cablecross-section					
all connectors	solid	mm ²		0,5 - 1,5	Solder Connector
	flexible	mm ²		0,5 - 1,5	Ø 1,15
	flexible with multicore cable end	mm ²		0,5 - 1,5	
Clamps per pole				2	-
	solid or stranded	AWG		20 - 14	-

1) Suitable at 690V for: earthed-neutral systems, overvoltage category I to III, pollution degree 3 (standard-industry); U_{imp} = 4kV.
Data for other conditions on request.

2) With reduced control voltage range 0,9 up to 1,0 x U_s and with reduced thermal rated current I_{th} to I_e/AC15.

3) Summary switching time = release time + arc duration.

4) Release time of NC make time of NO increase when suppressor units for voltage peak protection are used (Varistor, RC-units, Diode units).

5) Data on request.

Micro Contactors for North America

Data according to UL508

Main Contacts (cULus)		Type	K0-05D.. K0W05D01..	K0-04D..	K0-05L..	K0-04L..
Rated operational current "General Use"		A	12	5	9	5
Rated operational power of three motors at 60Hz (3ph)	110-120V	hp	1/2	-	1/2	-
	200-208V	hp	1	-	1	-
	220-240V	hp	1	-	1	-
	277V	hp	1 1/2	-	1 1/2	-
Rated operational power of AC motors at 60Hz (1ph)	110-120V	hp	1/6	-	1/6	-
	200-208V	hp	1/2	-	1/2	-
	220-240V	hp	3/4	-	3/4	-
Fuse / Short-circuit current		A/kA	30/5	-	30/5	-
Rated voltage		VAC	480	480	480	480
Auxiliary Contacts (cULus)						
	heavy pilot duty	AC	B300	B300	B300	B300
	standard pilot duty	DC	R300	R300	R300	R300

Motor Rating P_n = AC4

440/ 380/ 220/
460V 400V 230V
kW kW kW

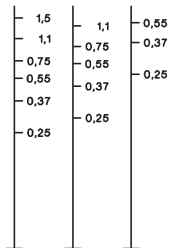

Motor Rating P_n = AC3

440/ 380/ 220/
460V 400V 230V
kW kW kW

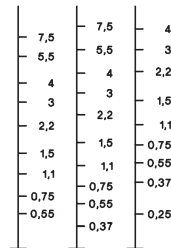

Breaking Current I_a (= I_e = AC1) A

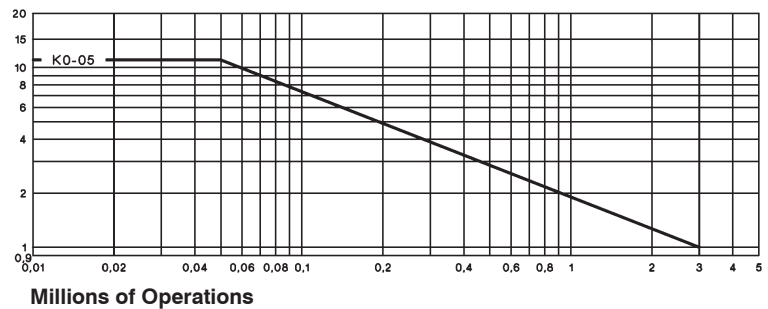

Micro Contactors

Dimensions

AC or DC operated
with screw terminals

K0-04D.. (=)
K0-05D.. (=)

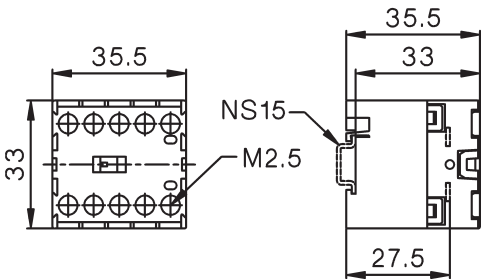

Snap-On Adapter P1039

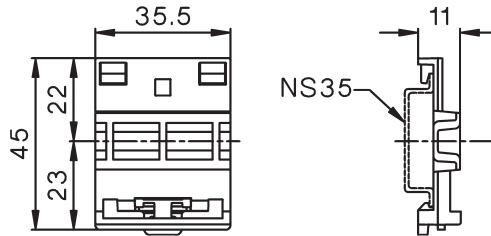

Reversing Contactors
with screw terminals

K0W05D..MC

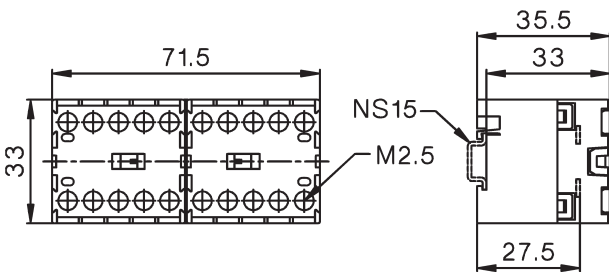

K0..D.. with Snap-On Adapter P1039

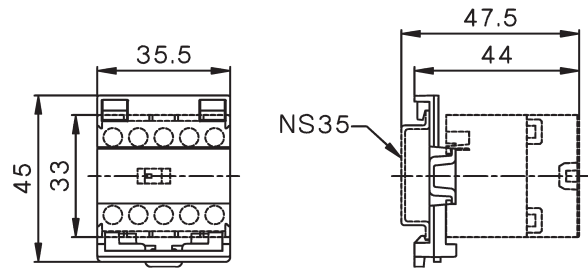

AC or DC operated
with solder connections



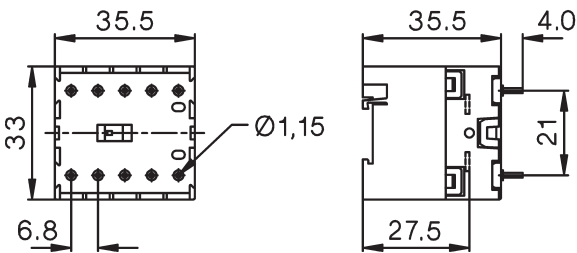

K0-04L.. (=)
K0-05L.. (=)

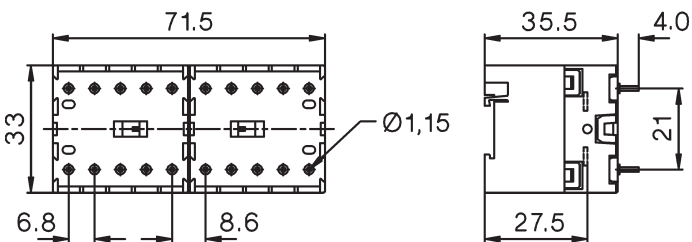

Reversing Contactors
with solder connections

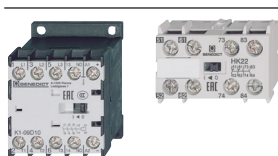
K0W05L..MC

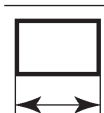

	<p>Mini Contactor Relays 4-pole Auxiliary Contact Blocks</p> <p>Interface Contactor Relays</p>	<p>26</p> <p>27</p>
	<p>Mini Contactors Auxiliary Contact Blocks</p>	<p>28</p>
	<p>Mini Contactors With Fast On Tab Connectors</p>	<p>30</p>
	<p>Mini Contactors With Solder Pins</p> <p>Coil voltages</p>	<p>30</p> <p>30</p>
	<p>Mini Reversing Contactors Auxiliary Contact Blocks</p>	<p>32</p>
	<p>Technical Data</p>	<p>33</p>
	<p>Dimensions</p>	<p>38</p>

Mini Contactor Relays 4-pole

AC Operated

Ratings	Therm. Distinc. Number	Contacts ²⁾ Additional Contact	Type	Coil voltage ¹⁾
AC15				24V 50/60Hz
230V A	400V A	NO NC		220-230V 50Hz
				24V 50/60Hz w. protection ³⁾
				220-230V 50Hz w. protection ³⁾
				24V 50/60Hz 24V= DC
				220-240V 50/60Hz 220V= DC
				Pack Weight pcs. kg/pc.

4-pole, With Screw Terminals



3	2	10	4	-	40E	1 HK..	K1-07D40 ...	10	0,16
3	2	10	3	1	31E	1 HK..	K1-07D31 ...	10	0,16
3	2	10	2	2	22E	1 HK..	K1-07D22 ...	10	0,16

Auxiliary Contact Blocks For Contactor Relays



Ratings	Thermal Rated Current	Contacts ²⁾ NO NC	Type	Pack pcs.	Weight kg/pc.
AC15					
230V A	400V A				
3	2	10	1 1	10	0,04
3	2	10	- 2	10	0,04
3	2	10	2 -	10	0,04
3	2	10	4 -	10	0,04
3	2	10	2 2	10	0,04
3	2	10	- 4	10	0,04

Aux. Contact Blocks

HK11 HK02 HK20 HK40 HK22 HK04

Wiring Diagrams

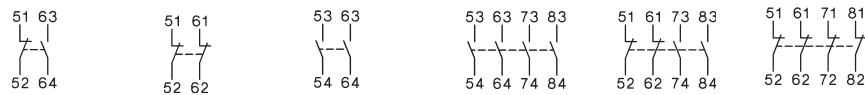



Distinc. Number according to EN50011 for Contactor Relay with Auxiliary Contact Block

K1-07D40	51E	42E	60E	80E	62E	44E
K1-07D31	42Y	33Y	51Y	71Y	53Y	35Y
K1-07D22	33Y	24Y	42Y	62Y	44Y	26Y

Preferable combinations with distinctive letter ".E" according to DIN EN 50011

1) Other coil voltages see page 30
 2) Contacts suitable for electronic circuits, according to EN947-5-4 for rated voltage 24V DC (test ratings 17V DC, 5mA) Mirror contacts acc. IEC60947-4-1 Annex F.
 3) with built-in coil suppressor (varistor)

DC Solenoid Operated

Type	Coil voltage ¹⁾		Contacts ²⁾		Additional Contact Blocks	Pack pcs.	Weight kg/pc.	Wiring Diagrams
	24	24VS	NO	NC				
	24V= DC	24V= DC with protection ²⁾			Distinc. Number acc. to EN50011			

4-pole, With Screw Terminals, Coil 2,5W



K1-07D40= ...	4	-	40E	1 HK..	10	0,19	
----------------------	---	---	-----	--------	----	------	---

K1-07D31= ...	3	1	31E	1 HK..	10	0,19	
----------------------	---	---	-----	--------	----	------	---

K1-07D22= ...	2	2	22E	1 HK..	10	0,19	
----------------------	---	---	-----	--------	----	------	---

4-pole, With Screw Terminals, Coil 1,5W, 19 to 30V DC with suppressor ³⁾



K1-07D40= 24VR	4	-	-	-	10	0,20	
-----------------------	---	---	---	---	----	------	---

K1-07D31= 24VR	3	1	-	-	10	0,20	
-----------------------	---	---	---	---	----	------	--

K1-07D22= 24VR	2	2	-	-	10	0,20	
-----------------------	---	---	---	---	----	------	---

1) Other coil voltages on request
 2) Contacts suitable for electronic circuits, according to EN947-5-4 for rated voltage 24V DC (test ratings 17V DC, 5mA) Mirror contacts acc. IEC60947-4-1 Annex F.
 3) with integrated coil suppressor (Transient Voltage Suppressor Diode)

Mini Contactors

AC Operated

Power Ratings	Rated Current	Aux. Contacts ²⁾		Type	Coil voltage ¹⁾	Pack pcs.	Weight kg/pc.
		Built-in	Additional				
AC2, AC3	AC1						
380V					24 24V 50/60Hz		
400V 660V					230 220-230V 50Hz		
415V 690V	690V				24VS 24V 50/60Hz w. protection ³⁾		
kW kW	A				230VS 220-230V 50Hz w. protection ³⁾		
					24VM 24V 50/60Hz 24V= DC		
					230VM 220-240V 50/60Hz 220V= DC		



3-pole, With Screw Terminals

Rated Current	Rated Voltage	Rated Power	Built-in	Additional	Type	Pack pcs.	Weight kg/pc.
4	4	20	1	-	1 HKM..	K1-09D10 ...	10 0,16
5,5	5,5	20	1	-	1 HKM..	K1-12D10 ...	10 0,16

Rated Current	Rated Voltage	Rated Power	Built-in	Additional	Type	Pack pcs.	Weight kg/pc.
4	4	20	-	1	1HK..	K1-09D01 ...	10 0,16
5,5	5,5	20	-	1	1HK..	K1-12D01 ...	10 0,16

4-pole, With Screw Terminals

Rated Current	Rated Voltage	Rated Power	Built-in	Additional	Type	Pack pcs.	Weight kg/pc.
4	4	20	-	-	1HK..	K1-09D00-40 ...	10 0,16
5,5	5,5	20	-	-	1HK..	K1-12D00-40 ...	10 0,16

Auxiliary Contact Blocks for Contactors K1-..

Ratings	Thermal Rated Current	Contacts ²⁾	Type	Pack pcs.	Weight kg/pc.
AC15					
230V	400V				
A	A	A	NO NC		
3	2	10	1 1	HKM11	10 0,04
3	2	10	- 2	HKM02	10 0,04
3	2	10	2 2	HKM22	10 0,04

Aux. Contact Blocks

HKM11

HKM02

HKM22

Wiring Diagrams

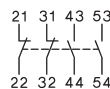

Contactors with Auxiliary Contact Block

Contacts according to EN50012

Contactors	HKM11	HKM02	HKM22	-	-	-	-
K1-..D10	21	12	32				

Contacts according to DIN EN50005

Contactors	HKM11	HKM02	HKM22	12	03	41	23
K1-..D01	-	-	-	12	03	41	23
K1-..D00-40	-	-	-	11	02	40	22

Prefer combinations according to EN50012

Suppressor Units for Contactors K1-..



Voltage Range V	Capacitance / Resistance	Type	Pack pcs.	Weight kg/pc.
12 - 48V AC/DC	1600nF / 22 Ohm	RC-K1 24	10	0,01
48 - 127V AC/DC	680nF / 270 Ohm	RC-K1 110	10	0,01
110 - 250V AC/DC	220nF / 2200 Ohm	RC-K1 230	10	0,01



1) Other coil voltages see page 30

2) Contacts suitable for electronic circuits, according to EN947-5-4 for rated voltage 24V DC (test ratings 17V DC, 5mA) Mirror contacts acc. IEC60947-4-1 Annex F.

3) with built-in coil suppressor (varistor)

DC Solenoid Operated

Type

Coil voltage ¹⁾	Aux. Contacts ²⁾	Additional
24 24V= DC	Built	Overload
24VS 24V= DC with protection ³⁾	in	Relay
↓	 	see page114
	NO NC	Type

Pack pcs. Weight kg/pc.

Wiring Diagrams



3-pole, With Screw Terminals, Coil 2,5W

K1-09D10= ...	1	-	1 HKM..	U12/16..K1	10	0,19
K1-12D10= ...	1	-	1 HKM..	U12/16..K1	10	0,19

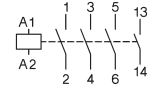

K1-09D01= ...	-	1	1 HK..	U12/16..K1	10	0,19
K1-12D01= ...	-	1	1 HK..	U12/16..K1	10	0,19

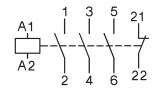

4-pole, With Screw Terminals, Coil 2,5W

K1-09D00-40= ...	-	-	-	U12/16..K1	10	0,19
K1-12D00-40= ...	-	-	-	U12/16..K1	10	0,19

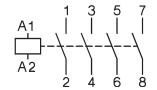

3-pole, With Screw Terminals, Coil 1,5W, 19 to 30V DC with suppressor ³⁾

K1-09D10=24VR	1	-	-	U12/16..K1	10	0,20
----------------------	---	---	---	------------	----	------

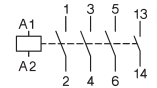

K1-09D01= 24VR -	-	1	-	U12/16..K1	10	0,20
-------------------------	---	---	---	------------	----	------

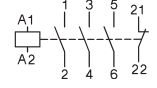

1) Other coil voltages on request
 2) Contacts suitable for electronic circuits, according to EN947-5-4 for rated voltage 24V DC (test ratings 17V DC, 5mA) Mirror contacts acc. IEC60947-4-1 Annex F.
 3) with integrated coil suppressor (Transient Voltage Suppressor Diode)

Mini Contactors

AC Operated

Power Ratings	Rated Current	Aux. Contacts ²⁾		Type	Coil voltage ¹⁾
		Built in	Additional		
AC2, AC3	AC1				24V 50/60Hz
380V					220-230V 50Hz
400V	660V				24V 50/60Hz w. protection ²⁾
415V	690V	690V			220-230V 50Hz w. protection ²⁾
kW	kW	A	NO NC	Type	24V 50/60Hz 24V DC
					230VM 220-240V 50/60Hz 220V DC
					↓
					Pack pcs.
					Weight kg/pc.

3-pole, with Fast On Tab Connectors 1 x 6,3mm or 2 x 2,8mm



4	4	16	1	-	1 HKM..	K1-09F10 ...	10	0,16
4	4	16	-	1	1 HK..	K1-09F01 ...	10	0,16

3-pole, with Solder Pins Ø1,15 for Printed Circuit Applications



4	4	16	1	-	-	K1-09L10 ...	10	0,16
4	4	16	-	1	-	K1-09L01 ...	10	0,16

4-pole, with Solder Pins Ø1,15 for Printed Circuit Applications

4	4	16	-	-	-	K1-09L00-40 ...	10	0,16
---	---	----	---	---	---	------------------------	----	------

Coil voltages for AC operated contactors

Suffix to contactor type e.g. K1-09D10 24	Voltage Marking at the coil for		Rated Control Voltage U _s range for 50Hz for 60Hz			
	50Hz	60Hz	min.	max.	min.	max.
12	12	12	11	12	12	12
24	24	24	22	24	24	24
42	42	42	38,5	42	42	42
48	48	48	48	50	48	52
90	100	100	90	100	100	105
95	95-100	105-110	95	100	105	110
100	100	110-115	100	105	110	115
105	105-110	115-120	105	110	115	120
110	110-115	120-125	110	115	120	125
180	200	200	185	200	200	210

Suffix to contactor type e.g. K1-09D10 230	Voltage Marking at the coil for		Rated Control Voltage U _s range for 50Hz for 60Hz			
	50Hz	60Hz	min.	max.	min.	max.
200	200	200-220	195	205	200	220
210	205-215	220-230	205	215	220	230
220	210-220	220-240	210	220	220	240
230	220-230	230-250	220	230	230	250
240	230-240	240-260	230	240	240	260
400	380-400	400-440	380	400	400	440
500	475-500	520-545	475	500	520	545
550	525-550	600	525	550	570	600

Standard voltages in bold type letters
Operating range of magnet-coils: 0,85 x U_s (min. value of rated control voltage) up to 1,1 x U_s (max. value of rated control voltage)

Coil not exchangeable

1) Other coil voltages see page 28

2) Contacts suitable for electronic circuits, according to EN947-5-4 for rated voltage 24V DC (test ratings 17V DC, 5mA) Mirror contacts acc. IEC60947-4-1 Annex F.

3) with built-in coil suppressor (varistor)

DC Solenoid Operated

Type

Coil voltage ¹⁾	Aux. Contacts ²⁾	Additional	Pack	Weight
24 24V= DC	Built	Overload	pcs.	kg/pc.
24VS 24V= DC with protection ³⁾	in	Relay see pages 115, 117		
↓	NO NC	Type		



3-pole, with Fast On Tab Connectors 1 x 6,3mm or 2 x 2,8mm

K1-09F10= . . .	1	-	1 HKM.. ⁴⁾	10	0,19
------------------------	---	---	-----------------------	----	------

Wiring Diagrams

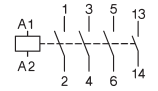

K1-09F01= . . .	-	1	1 HK.. ⁴⁾	10	0,19
------------------------	---	---	----------------------	----	------

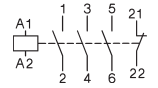

3-pole, with Solder Pins Ø1,15 for Printed Circuit Applications



K1-09L10= . . .	1	-	-	10	0,19
------------------------	---	---	---	----	------

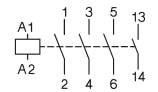

K1-09L01= . . .	-	1	-	10	0,19
------------------------	---	---	---	----	------

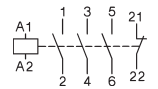

4-pole, with Solder Pins Ø1,15 for Printed Circuit Applications

K1-09L00-40= . . .	-	-	-	10	0,19
---------------------------	---	---	---	----	------

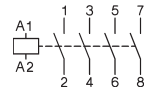

1) Other coil voltages on request
 2) Contacts suitable for electronic circuits, according to EN947-5-4 for rated voltage 24V DC (test ratings 17V DC, 5mA) Mirror contacts acc. IEC60947-4-1 Annex F.
 3) with integrated coil suppressor (Transient Voltage Suppressor Diode)
 4) U12/16E K3 with U12SMK3 for single mounting

Mini Reversing Contactors, Mechanical Interlocked

AC Operated

Power Ratings	Rated Current	AC1	Aux. Contacts ²⁾		Type	Coil voltage ¹⁾	Pack pcs.	Weight kg/pc.
			Built-in	Additional on left hand side Contactor				
AC2, AC3						24V 50/60Hz		
380V						220-230V 50Hz		
400V	660V					24V 50/60Hz w. protection ³⁾		
415V	690V	690V				220-230V 50Hz w. prot. ³⁾		
kW	kW	A				24V 50/60Hz 24V DC		
			NO NC	K1 Type	K2 Type	220-240V 50/60Hz 220V DC		

3-pole, with Screw Terminals



4	4	20	-	2	HKM11V	HKM11X	K1W09D01MC ...	1	0,32
5,5	5,5	20	-	2	HKM11V	HKM11X	K1W12D01MC ...	1	0,32
4	4	20	2	-	HKM..	HKM..	K1W09D10MC ...	1	0,32
5,5	5,5	20	2	-	HKM..	HKM..	K1W12D10MC ...	1	0,32

4-pole, with Screw Terminals

4	4	20	-	-	HKM..	HKM..	K1W09D00-40MC ..	1	0,32
5,5	5,5	20	-	-	HKM..	HKM..	K1W12D00-40MC ..	1	0,32

3-pole, with Solder Pins Ø1,15 for Printed Circuit Applications

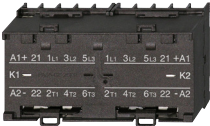

4	4	16	-	2	-	-	K1W09L01MC ...	1	0,32
4	4	16	2	-	-	-	K1W09L10MC ...	1	0,32

Auxiliary Contact Blocks for Mini Reversing Contactors K1-..

Ratings	AC15	400V	Thermal Rated Current	Contacts ²⁾		Type	Pack pcs.	Weight kg/pc.
				NO	NC			
3	2		10	1	1	HKM11V	10	0,04
3	2		10	1	1	HKM11X	10	0,04



Aux. Contact Blocks

HKM11V HKM11X

Wiring Diagrams



Reversing Starter Connector



For Reversing Starter Types, incl. Coil Connector

Type	Pack pcs.	Weight kg/pc.
K1W09D..MC, K1W12D..MC	1	0,01

1) Other coil voltages see page 30
 2) Contacts suitable for electronic circuits, according to EN947-5-4 for rated voltage 24V DC (test ratings 17V DC, 5mA) Mirror contacts acc. IEC60947-4-1 Annex F.
 3) with built-in coil suppressor (varistor)

DC Solenoid Operated

Type

24 Coil voltage ¹⁾
24VS 24V= DC
 ↓ 24V= DC with protection ²⁾

Additional
 Overload
 Relay
 see
 page114
 Type

Pack pcs. Weight kg/pc.

Wiring Diagrams



3-pole, with Screw Terminals

K1W09D01MC= ...	U12/16..K1	1	0,32
K1W12D01MC= ...	U12/16..K1	1	0,32
K1W09D10MC= ...	U12/16..K1	1	0,32
K1W12D10MC= ...	U12/16..K1	1	0,32

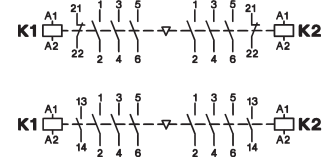

4-pole, with Screw Terminals

K1W09D00-40MC= ..	U12/16..K1	1	0,32
K1W12D00-40MC= ..	U12/16..K1	1	0,32



3-pole, with Solder Pins Ø1,15 for Printed Circuits Applications



K1W09L01MC= ...	-	1	0,32
K1W09L10MC= ...	-	1	0,32

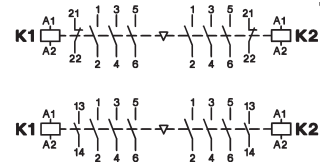

1) Other coil voltages on request
 2) with integrated coil suppressor (Transient Voltage Suppressor Diode)

Mini Contactors

Data according to IEC 947-4-1, VDE 0660, EN 60947-4-1

Main Contacts	Type	K1-09D..	K1-09F..	K1-09L..	K1-12D..
Rated insulation voltage U_i	V AC	690 ¹⁾	690 ¹⁾	690 ²⁾	690 ¹⁾
Making capacity I_{eff}	at $U_e = 690V$ AC	A	165	165	165
Breaking capacity I_{eff}	400V AC	A	100	100	100
$\cos\varphi = 0,65$	500V AC	A	90	90	90
	690V AC	A	80	80	80
Utilization category AC1					
Switching of resistive load					
Rated operational current $I_e (=I_{th})$ at 40°C, open	A	20	16	16	20
Rated operational power of three-phase resistive loads					
50-60Hz, $\cos\varphi = 1$	230V kW	7,9	6	6	7,9
	240V kW	8,3	6,5	6,5	8,3
	400V kW	13,8	11	11	13,8
	415V kW	14,3	11,5	11,5	14,3
Rated operational current $I_e (=I_{the})$ at 60°C, enclosed	A	16	12	12	16
Rated operational power of three-phase resistive loads					
50-60Hz, $\cos\varphi = 1$	230V kW	6,3	4,5	4,5	6,3
	240V kW	6,7	5	5	6,7
	400V kW	11	8	8	11
	415V kW	11,5	8,5	8,5	11,5
Minimum cross-section of conductor at load with $I_e (=I_{th})$	mm ²	2,5	2,5	-	2,5
Utilization category AC2 and AC3					
Switching of three-phase motors					
Rated operational current I_e					
open and enclosed	220V A	12	12	12	15
	230V A	11,5	11,5	11,5	14,5
	240V A	11	11	11	14
	380-400V A	9	9	9	12
	415-440V A	8	8	8	11
	500V A	7	7	7	9
	660-690V A	5	5	5	6,5
Rated operational power of three-phase motors					
50-60Hz	220-240V kW	3	3	3	4
	380-440V kW	4	4	4	5,5
	500-690V kW	4	4	4	5,5
Utilization category AC4					
Switching of squirrel cage motors, inching					
Rated operational current I_e					
open and enclosed	220V A	12	12	12	15
	230V A	11,5	11,5	11,5	14,5
	240V A	11	11	11	14
	380-400V A	9	9	9	12
	415-440V A	8	8	8	11
	500V A	7	7	7	9
	660-690V A	5	5	5	6,5
Rated operational power of three-phase motors					
50-60Hz	220-240V kW	3	3	3	4
	380-440V kW	4	4	4	5,5
	500-690V kW	4	4	4	5,5
Utilization category AC5a					
Switching of gas discharge lamps					
Rated operational current I_e					
per pole at 220/230V					
Fluorescent lamps,					
uncompensated and serial compensated	A	10	10	10	10
parallel compensated	A	2	2	2	2
dual-connection	A	16	16	16	16
Metal halide lamps ³⁾ ,					
uncompensated	A	10	10	10	10
parallel compensated	A	2	2	2	2
Mercury-vapour lamps ⁴⁾ ,					
uncompensated	A	16	16	16	16
parallel compensated	A	2	2	2	2
Mixed light lamps ⁵⁾	A	16	16	16	16
LED-Lamps					
consider the inrush current of the lamp ballast					
and $\cos\varphi$ of the lamp	max. lamps per pole ($I_{rLED} \leq I_{th}$)	=	inrush current of contactor		
			inrush current of lamp/EVG		
max inrush current of contactor	A	233	233	233	233
Utilization category AC5b Switching of incandescent lamps ⁶⁾					
Rated operational current I_e					

1) Suitable at 690V for: earthed-neutral systems, overvoltage category I to IV, pollution degree 3 (standard-industry); $U_{imp} = 8kV$. Data for other conditions on request.

2) Suitable at 690V for pollution degree 2, $U_{imp} = 6kV$.

Pollution degree 3 $U_i = 690V$ non-tracking of the printed circuit CTI ≥ 600

Pollution degree 3 $U_i = 500V$ non-tracking of the printed circuit CTI ≥ 400

Pollution degree 3 $U_i = 400V$ non-tracking of the printed circuit CTI ≥ 100

3) Metal halide lamps and sodium-vapour lamps (high- and low-pressure lamps)

4) High-pressure lamps

5) Blended lamps, containing a mercury high-pressure unit and a tungsten helix in a fluorescent glass bulb (daylight lamps)

6) Current inrush approx. $16 \times I_e$

Mini Contactors

Data according to IEC 947-4-1, VDE 0660, EN 60947-4-1

Main Contacts	Type	K1-09D..	K1-09F..	K1-09L..	K1-12D..	
Utilization category DC1						
Switching of resistive load	1 pole 24V	A	20	16	16	20
Time constant L/R ≤15ms	60V	A	20	16	16	20
Rated operational current I _e	110V	A	5	5	5	5
	220V	A	0,6	0,6	0,6	0,6
3 poles in series	24V	A	20	20	20	20
	60V	A	20	20	20	20
	110V	A	20	20	20	20
	220V	A	16	16	16	16
Utilization category DC3 and DC5						
Switching of shunt motors and series motors	1 pole 24V	A	20	16	16	20
Time constant L/R ≤15ms	60V	A	5	5	5	5
Rated operational current I _e	110V	A	1	1	1	1
	220V	A	0,15	0,15	0,15	0,15
3 poles in series	24V	A	20	16	16	20
	60V	A	20	16	16	20
	110V	A	20	16	16	20
	220V	A	2	2	2	2
Maximum ambient temperature						
Operation	open	°C	-40 to +60 (+90) ¹⁾			
	enclosed	°C	-40 to +40			
with thermal overload relay	open	°C	-25 to +60			
	enclosed	°C	-25 to +40			
Storage		°C	-50 to +90			
Short circuit protection						
for contactors without thermal overload relay						
Coordination-type "1" according to IEC 947-4-1						
Contact welding without hazard of persons max. fuse size	gL (gG)	A	40	40	40	40
Coordination-type "2" according to IEC 947-4-1						
Light contact welding accepted max. fuse size	gL (gG)	A	25	25	25	25
Contact welding not accepted max. fuse size	gL (gG)	A	10	10	10	10
For contactors with thermal overload relay the device with the smaller admissible backup fuse (contactor or thermal overload relay) determines the fuse size.						
Cable cross-sections						
for contactors without thermal overload relay						
main connector	solid or stranded	mm ²	0,5 - 2,5	Fast on	Solder connector	0,5 - 2,5
	flexible	mm ²	0,5 - 2,5	1x 6,3 x 0,8	Ø 1,15	0,5 - 2,5
Cables per clamp	flexible with multicore cable end	mm ²	0,5 - 1,5	or	-	0,5 - 1,5
	solid or stranded	AWG	2	2x 2,8 x 0,8	-	2
Frequency of operations z						
Contactors without thermal overload relay						
	without load	1/h	10000	10000	10000	10000
	AC3, I _e	1/h	600	600	600	700
	AC4, I _e	1/h	120	120	120	150
	DC3, I _e	1/h	600	600	600	700
Mechanical life						
AC operated	S x	10 ⁶	5	5	5	5
DC operated	S x	10 ⁶	15	15	15	15
Short time current						
	10s-current	A	96	96	96	120
Power loss per pole						
	at I _e /AC3 400V	W	0,15	0,15	0,15	0,25
Resistance to shock according to IEC 68-2-27						
Shock time 20ms sine-wave						
AC operated	NO	g	5	5	5	5
	NC	g	5	5	5	5
DC operated	NO	g	8	8	8	8
	NC	g	6	6	6	6

1) With reduced control voltage range 0,9 up to 1,0 x U_s and with reduced rated current I_e/AC1 according to I_e/AC3

Mini Contactors

Data according to IEC 947-5-1, VDE 0660, EN 60947-5-1

Auxiliary Contacts			Type	K1-07D.. K1-09D.. K1-12D..	K1-07D..=(VM) K1-09D..=(VM) K1-12D..=(VM)	K1-07D..= 24VR K1-09D..= 24VR	K1-09F..=(VM)	K1-07L..=(VM) K1-09L..=(VM)	HK..
Rated insulation voltage U_i			V AC	690 ¹⁾	690 ¹⁾	690 ¹⁾	690 ¹⁾	690 ²⁾	690 ¹⁾
Thermal rated current I_{th} to 690V									
Ambient temperature			40°C A	10	10	10	10	10	10
			60°C A	6	6	6	6	6	6
Power loss per pole			at I_{th} W	0,5	0,5	0,5	0,5	0,5	0,5
Utilization category AC15									
Rated operational current I_e			220-240V A	3	3	3	3	3	3
			380-415V A	2	2	2	2	2	2
			440V A	1,6	1,6	1,6	1,6	1,6	1,6
			500V A	1,2	1,2	1,2	1,2	1,2	1,2
			660-690V A	0,6	0,6	0,6	0,6	0,6	0,6
Utilization category DC13									
Rated operational current I_e			60V A	2	2	2	2	2	2
			110V A	0,4	0,4	0,4	0,4	0,4	0,4
			220V A	0,1	0,1	0,1	0,1	0,1	0,1
Maximum ambient temperature									
Operation			open °C	-40 to +60 (+90) ³⁾					
			enclosed °C	-40 to +40					
Storage			°C	-40 to +90					
Short circuit protection									
short-circuit current 1kA, contact welding not accepted max. fuse size			gL (gG) A	20	20	20	20	20	20
For contactors with thermal overload relay the device with the smaller admissible control fuse (contactor or thermal overload relay) determines the fuse size.									
Power consumption of coils									
AC operated			inrush VA	25	-	-	25	25	-
			sealed VA	4 - 5	-	-	4 - 5	4 - 5	-
			W	1,2	-	-	1,2	1,2	-
DC operated			inrush W	-	2,5	1,5	2,5	2,5	-
and ...VM (AC/DC)			sealed W	-	2,5	1,5	2,5	2,5	-
Operation range of coils									
in multiples of control voltage U_s				0,85 - 1,1	0,8 - 1,1	19 - 30V DC	0,85 - 1,1	0,85 - 1,1	-
Switching time at control voltage $U_s \pm 10\%$ ^{4) 5)}									
AC operated			make time ms	15 - 19	-	-	15 - 19	15 - 19	-
			release time ms	8 - 25	-	-	8 - 25	8 - 25	-
			arc duration ms	10 - 15	-	-	10 - 15	10 - 15	-
DC operated			make time ms	-	15 - 50	15 - 50	15 - 50	15 - 50	-
			release time ms	-	8 - 25	8 - 25	8 - 25	8 - 25	-
			arc duration ms	-	10 - 15	10 - 15	10 - 15	10 - 15	-
Cable cross-section									
all connectors			solid mm ²	0,5 - 2,5	0,5 - 2,5	0,5 - 2,5	Fast on	Solder connector	0,5 - 2,5
			flexible mm ²	0,5 - 2,5	0,5 - 2,5	0,5 - 2,5	1x 6,3 x 0,8	Ø 1,15	0,5 - 2,5
			flexible with multicore cable end mm ²	0,5 - 1,5	0,5 - 1,5	0,5 - 1,5	or		0,5 - 1,5
							2x 2,8 x 0,8		
Clamps per pole				2	2	2	-	-	2
			solid or stranded AWG	18 - 14	18 - 14	18 - 14			18 - 14

1) Suitable at 690V for: earthed-neutral systems, overvoltage category I to IV, pollution degree 3 (standard-industry): $U_{imp} = 8kV$.
Data for other conditions on request.

2) Suitable at 690V for pollution degree 2, $U_{imp} = 6kV$.
Pollution degree 3 $U_i = 690V$ non-tracking of the printed circuit CTI ≥ 600
Pollution degree 3 $U_i = 500V$ non-tracking of the printed circuit CTI ≥ 400
Pollution degree 3 $U_i = 400V$ non-tracking of the printed circuit CTI ≥ 100

3) With reduced control voltage range 0,9 up to $1,0 \times U_s$ and with reduced thermal rated current I_{th} to $I_e/AC15$

4) Summary switching time = release time + arc duration

5) Release time of NC make time of NO increase when suppressor units for voltage peak protection are used (Varistor, RC-units, Diode units).

Mini Contactors for North America

Data according to UL508

Main Contacts (cULus)		Type	K1-09D.. K1W09D01	K1-09F..	K1-09L..	K1-07D..	K1-12D.. K1W12D01	HK..
Rated operational current "General Use"		A	15	15	20	10	20	10
Rated operational power of three-phase motors at 60Hz (3ph)	110-120V	hp	1½	1½	1½	-	2	-
	200-208V	hp	3	3	3	-	3	-
	220-240V	hp	3	3	3	-	3	-
	440-480V	hp	5	5	5	-	7½	-
	550-600V	hp	7½	7½	7½	-	10	-
Rated operational power of AC motors at 60Hz (1ph)	110-120V	hp	½	½	½	-	¾	-
	200-208V	hp	1	1	1	-	1½	-
	220-240V	hp	1½	1½	1½	-	2	-
Fuse / Short-circuit current		A/kA	30/5	30/5	30/5	-	30/5	-
Rated voltage		V AC	600	600	600 ¹⁾	600	600	600
Auxiliary Contacts (cULus)		heavy pilot duty standard pilot duty	AC DC	A600 Q600	A600 Q600	A600 Q600	A600 Q600	A600 Q600

Motor Rating P_n = AC4

660V	500V	380V	220V
690V	400V	400V	230V
kW	kW	kW	kW
110	75	55	30
90	55	45	22
75	45	37	18,5
55	37	30	15
45	30	22	11
37	22	18,5	7,5
30	18,5	15	5,5
22	15	11	4
18,5	11	7,5	3
15	7,5	5,5	2,2
11	5,5	4	1,5
7,5	4	3	1,1
5,5	3	2,2	0,75
4	2,2	1,5	0,55
3	1,5	1,1	0,37
2,2	1,1	0,75	0,25
1,5	0,75	0,55	
1,1	0,55	0,37	
0,75	0,37	0,25	
0,55	0,25		
0,37			
0,25			

Motor Rating P_n = AC3

660V	500V	380V	220V
690V	400V	400V	230V
kW	kW	kW	kW
600	400	315	200
600	315	250	160
400	250	200	132
315	200	160	110
250	160	132	90
200	132	110	75
160	110	90	55
132	90	75	45
110	75	55	37
90	55	45	30
75	45	37	22
55	37	30	18,5
45	30	22	15
37	22	18,5	11
30	18,5	15	7,5
22	15	11	5,5
18,5	11	7,5	4
15	7,5	5,5	3
11	5,5	4	2,2
7,5	4	3	1,5
5,5	3	2,2	1,1
4	2,2	1,5	0,75
3	1,5	1,1	0,55
2,2	1,1	0,75	0,37
1,5	0,75	0,55	0,25
1,1	0,55	0,37	
0,75	0,37	0,25	
0,55	0,25		
0,37			
0,25			

Breaking Current I_a (= I_e = AC1) A

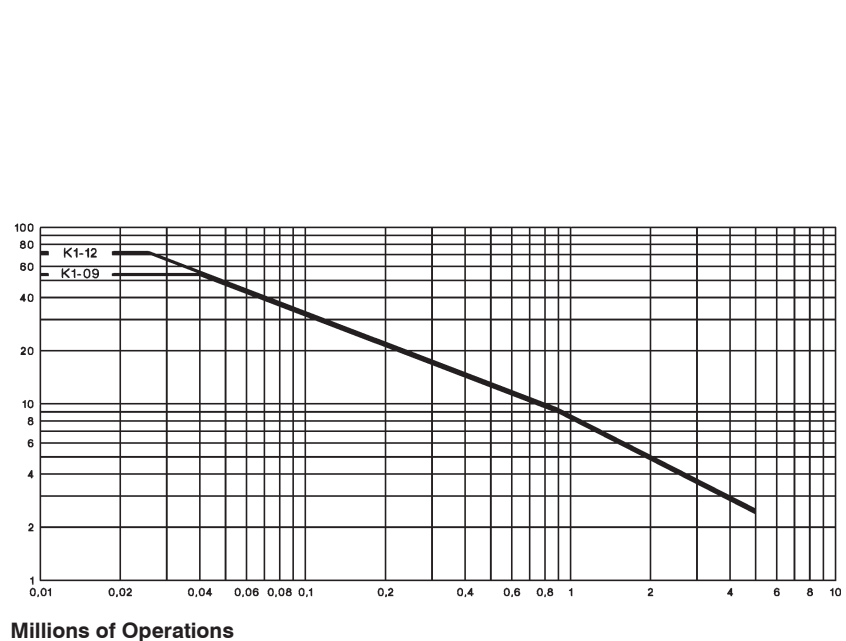

1) Pollution degree	CTI - PWB	U _i
2	≥ 100	600V
3	≥ 400	480V
3	100 - 400	240V

Contactors, Motor-Starters
 Circuit Breakers
 Manual Motor-Starters
 Switches
 AC-Main Switches
 DC-Switch Disconnector
 Push Buttons
 Representatives, Suppliers

Mini Contactors

Dimensions

AC and DC operated
with screw terminals

K1-07D..
K1-09D..
K1-12D..

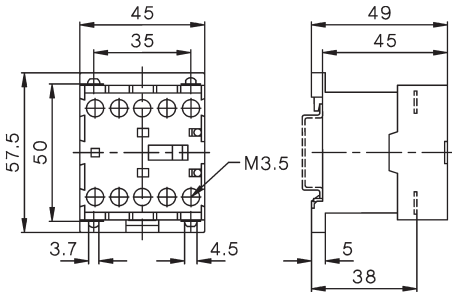

with fast on terminals

K1-07F..
K1-09F..

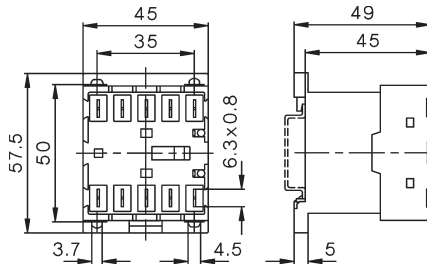

AC and DC operated
with solder connections

K1-07L..
K1-09L..

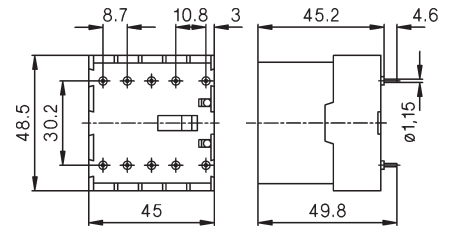

Auxiliary Contact Blocks

HK..

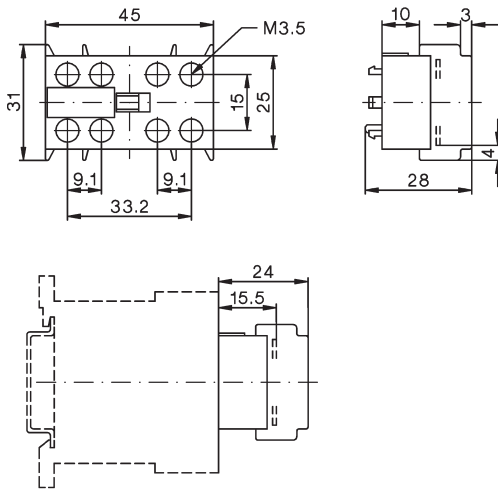

Suppressor Units

RC-K1

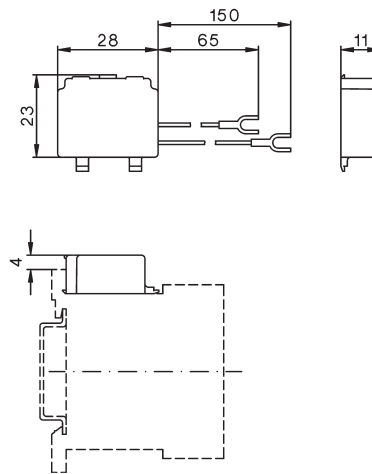

Reversing Contactors

K1W09D..MC
K1W12D..MC

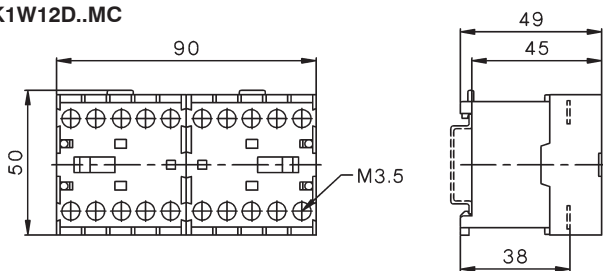

Reversing Contactors

K1W09L..MC

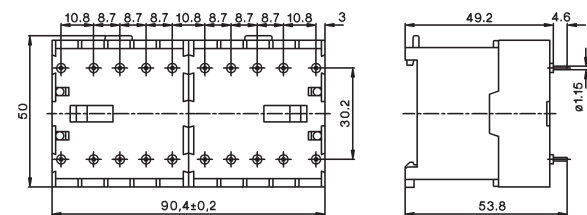

K1-09 + U12/16.. K1
K1-12

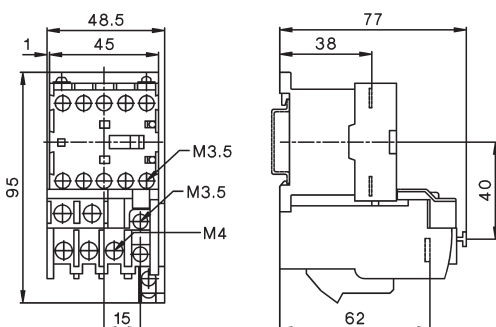

K1W09D..MC + U12/16E K1
K1W09D..MC + U12/16E K1

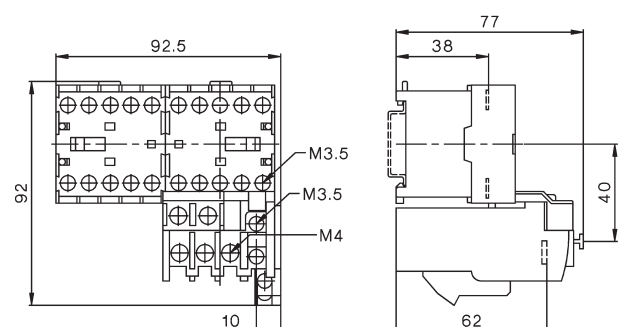



Contactor Relays 4-pole, AC Operated

40



Auxiliary Contact Blocks 1-pole

40



Contactor Relays 4-pole, DC Operated

41



Technical Data

42



Dimensions

44

Contactors Relays

AC Operated

Ratings		Contacts				Type	Coil voltage ¹⁾					
AC15	Therm. Rated Current	Built-in	Distinc. Number acc. to	Additional Contact Blocks		24	110	230	400			
230V	A	I_{th}	NO	NC	EN50011	Type	24V 50/60Hz	110V 50Hz	110-120V 60Hz	220-240V 50Hz	230-264V 60Hz	400-440V 60Hz
A	A	A									Pack pcs.	Weight kg/pc.



4-pole, contacts suitable for electronic circuits according to EN947-5-4²⁾

4	2	10	4	-	40E	max. 4	K3-07ND40 ...	1	0,22
4	2	10	3	1	31E	HN..	K3-07ND31 ...	1	0,22
4	2	10	2	2	22E	max. 2	K3-07ND22 ...	1	0,22
4	2	10	-	4	04E	HB..	K3-07ND04 ...	1	0,22

Auxiliary Contact Blocks ³⁾

Ratings		Contacts ²⁾				Type	Pack pcs.	Weight kg/pc.
AC15	Thermal Rated Current	Built-in	Distinc. Number acc. to	Additional Contact Blocks				
230V	A	I_{th}	NO	NC	EM	LB		
A	A	A						



1-pole, contacts suitable for electronic circuits according to EN947-5-4²⁾

3	2	10	1	-	-	-	HN10	10	0,02
3	2	10	-	1	-	-	HN01	10	0,02
3	2	10	-	-	1	-	HN10U	10	0,02
3	2	10	-	-	-	1	HN01U	10	0,02

1-pole, for high switching capacity

6	3	25	1	-	-	-	HA10	10	0,03
6	3	25	-	1	-	-	HA01	10	0,03

Accessories see pages 52 - 55.

1) Other coil voltages see page 57

2) Contacts suitable for electronic circuits, according to EN947-5-4 for rated voltage 24V DC (test ratings 17V DC, 5mA) Mirror contacts acc. IEC60947-4-1 Annex F.

3) Technical Data see page 62

DC Operated

Type	Coil voltage ¹⁾		Contacts			Pack pcs.	Weight kg/pc.	Wiring Diagrams
	24	48	Built-in	Distinc. Number acc. to	Additional Contact Blocks			
	24V DC	48V DC						
	110V DC	220V DC						
	↓		NO	NC	EN50011	Type		



3W Coil power, for high switching capacity ³⁾

KG3-07A40 ...	4	-	40E	max. 4	1	0,53
KG3-07A31 ...	3	1	31E	HN..	1	0,53
KG3-07A22 ...	2	2	22E	or	1	0,53
KG3-07A04 ...	-	4	04E	HA..	1	0,53

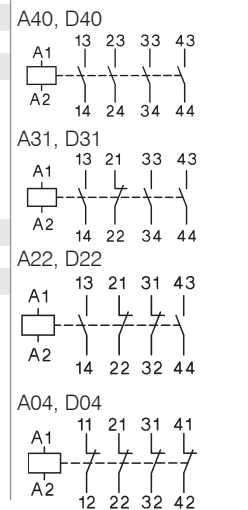

3W Coil power, for electronic circuits ²⁾³⁾

KG3-07D40 ...	4	-	40E	max. 4	1	0,53
KG3-07D31 ...	3	1	31E	HN..	1	0,53
KG3-07D22 ...	2	2	22E		1	0,53
KG3-07D04 ...	-	4	04E		1	0,53

with double winding coil, for electronic circuits ²⁾

K3-07ND40= ...	4	-	40E	max. 3	1	0,25
K3-07ND31= ...	3	1	31E	HN..	1	0,25
K3-07ND22= ...	2	2	22E	max. 2	1	0,25
K3-07ND04= ...	-	4	04E	HB..	1	0,25

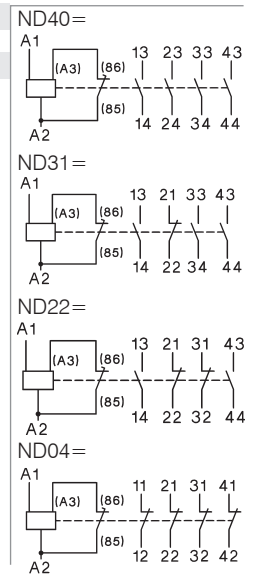

1) Other coil voltages on request
 2) Contacts suitable for electronic circuits, according to EN947-5-4 for rated voltage 24V DC (test ratings 17V DC, 5mA) Mirror contacts acc. IEC60947-4-1 Annex F.
 3) with integrated coil suppressor (Transient Voltage Suppressor Diode)

Contactors Relays

Data according to IEC 947-5-1, VDE 0660, EN 60947-5-1

			Type	K3-07ND	K3-07ND=	KG3-07A	KG3-07D
Rated insulation voltage U_i¹⁾			V AC	690	690	690	690
Thermal rated current I_{th} to 690V							
Ambient temperature			40°C A	10	10	20	10
			60°C A	6	6	16	6
Frequency of operations z			1/h	10000	10000	10000	10000
Mechanical life			S x 10 ⁶	10	10	10	50
Utilization category AC15							
Rated operational current I_e			220-240V A	4	4	12	4
			380-415V A	2	2	4	2
			440V A	1,6	1,6	4	1,6
			500V A	1,2	1,2	3	1,2
			660-690V A	0,6	0,6	1	0,6
Utilization category DC13							
Rated operational current I_e			24-60V A	3,5	3,5	8	3,5
per pole			110V A	0,5	0,5	1	0,5
			220V A	0,1	0,1	0,1	0,1
Power consumption of coils							
AC operated			inrush VA	30 - 45	-	-	-
			sealed VA	7 - 10	-	-	-
			W	2,6 - 3	-	-	-
DC operated			inrush W	-	75	3	3
			sealed W	-	2	3	3
Operation range of coils							
in multiples of control voltage U_s				0,85 - 1,1	0,8 - 1,1	0,8 - 1,1	0,8 - 1,1
Switching time at control voltage $U_s \pm 10\%$							
make time			ms	8 - 16	8 - 16	65 - 85	65 - 85
release time			ms	5 - 13	5 - 13	20 - 30 ³⁾	20 - 30 ³⁾
Maximum ambient temperature							
Operation			open °C	-40 to +60 (+90) ²⁾			
			enclosed °C				
Storage			°C	-40 to +40			
				-40 to +90			
Short circuit protection							
short-circuit current 1kA, contact welding not accepted max. fuse size			gL (gG) A	20	20	25	20
Cable cross-section							
Connector			solid mm ²	0,75 - 6			
			flexible mm ²	1 - 4			
			flexible with multicore cable end mm ²	0,75 - 4			
Magnet coil			solid mm ²	0,75 - 2,5			
			flexible mm ²	0,75 - 2,5			
			flexible with multicore cable end mm ²	0,5 - 1,5			
Clamps per pole				2			
Connector			solid AWG	18 - 10			
			flexible AWG	18 - 10			
Clamps per pole				2			
Magnet coil			solid AWG	14 - 12			
			flexible AWG	18 - 12			
Clamps per pole				2			

Data according to UL508

Rated operational current "General Use"			A	10	10	20	10
Rated operational voltage			max. V AC	600	600	600	600
Auxiliary Contacts			heavy pilot duty	A600	A600	A600	A600

1) Suitable at 690V for: earthed-neutral systems, overvoltage category I to IV, pollution degree 3 (standard-industry): $U_{imp} = 8kV$.
Data for other conditions on request.

2) With reduced control voltage range 0,9 up to 1,0 x U_s and with reduced thermal rated current I_{th} according to $I_e/AC15$

3) with built-in coil suppressor

Contactor Relays

Position of Terminals

AC operated

K3-07ND22

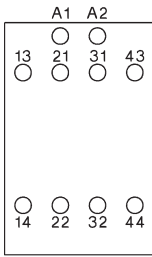

K3-07ND31

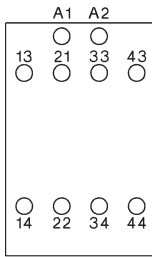

K3-07ND40

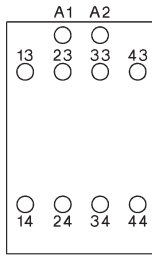

K3-07ND04

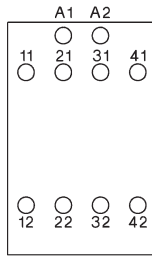

DC operated with double wound coil

K3-07ND22=

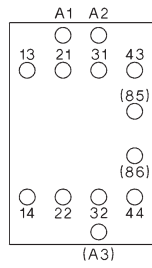

K3-07ND31=

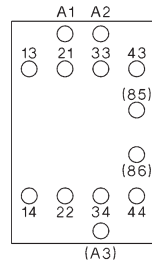

K3-07ND40=

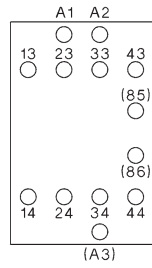

K3-07ND04=

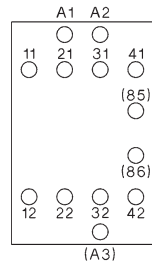

DC solenoid operated

KG3-07A22
KG3-07D22

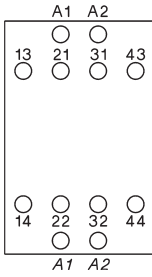

KG3-07A31
KG3-07D31

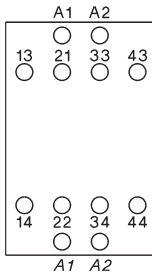

KG3-07A40
KG3-07D40

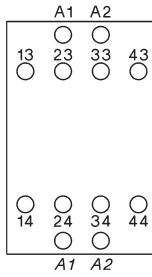

KG3-07A04
KG3-07D04

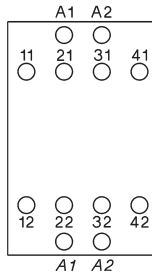

Contactors Relays

Dimensions

AC operated

K3-07ND..

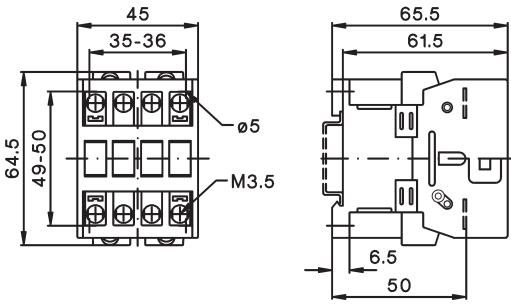

DC solenoid operated

KG3-07..

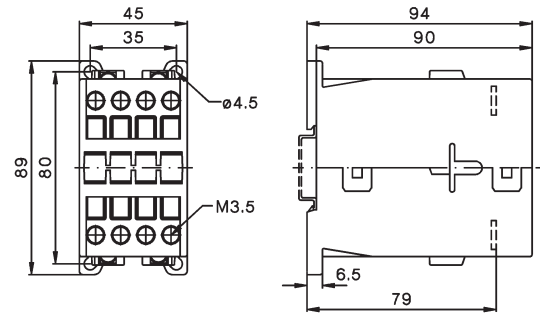

DC operated with double winding coil

K3-07ND.. =

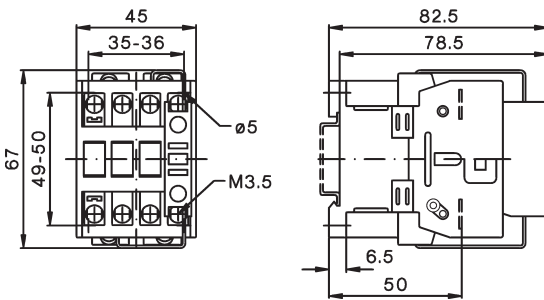





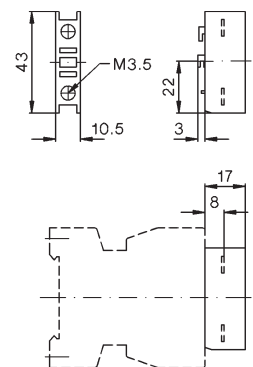



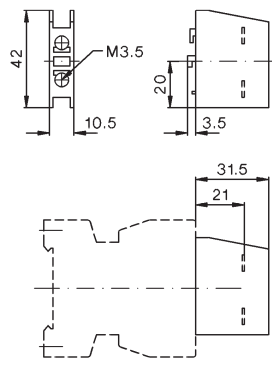







Auxiliary contact blocks

HN10, HN01

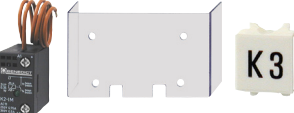

HA10, HA01



	Contactor overview	46
	Contactors 3-pole, AC Operated	48
	Contactors 3-pole, DC Operated	49
	Contactors 4-pole	50
	Capacitor Switching Contactors	51
	Auxiliary Contact Blocks Snap-on Momentary Contacts Additional Fourth Poles for Contactors	52
	Pneumatic Timers Electronic Timers On-delay Electronic Timers Off-delay	53
	Mechanical Interlocks Latches Additional Terminals, Parallel Connectors	54
	Indicator Units Fuse Holders Suppressor Units	55
	Interface Terminal Covers Mounting Parts	56
	Control Voltages	57
	Spare Coils AC-operated Feeder Groups	58
	Spare Coils DC-operated Spare Contacts	59
	Technical Data	62
	Dimensions	82





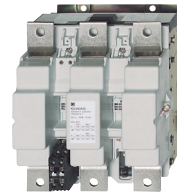

Contactors 3-pole

- Up to 1200A AC3
- Up to 1350A AC1
- DIN-rail mounting up to AC3 115A
- International Approvals
- Data according to IEC 947 / EN 60947



Ratings		10A	14A	18A	22A	24A	32A	40A	50A	62A	74A	90A	115A		
AC3 400V	Motor	4kW	5,5kW	7,5kW	11kW	11kW	15kW	18,5kW	22kW	30kW	37kW	45kW	55kW		
	380-400V 660-690V	5,5kW	7,5kW	10kW	10kW	15kW	18,5kW	18,5kW	30kW	37kW	45kW	55kW	55kW		
AC1 690V at 40°C		25A	25A	32A	32A	50A	65A	80A	110A	120A	130A	160A	200A		
Type	K3-	10ND10	14ND10	18ND10	22ND10	24A00	32A00	40A00	50A00	62A00	74A00	90A00	115A00		
Auxiliary contacts		1NO	1NO	1NO	1NO	-	-	-	-	-	-	-	-		
Type	K3-	10ND01	14ND01	18ND01	22ND01										
Auxiliary contacts		1NC	1NC	1NC	1NC										
Cable cross-section															
Solid	mm ²	0,75 - 6				1,5 - 25			4 - 50			10 - 120			
Flexible	mm ²	1 - 4				2,5 - 16			10 - 35			10 - 95			
Auxiliary contact															
I _{th} 40°C	A	10				-			-			-			
AC15 230V	A	3				-			-			-			
400V	A	2				-			-			-			
Power consumption		33 - 45				90 - 115			140 - 165			280			
of coils	hold VA	7 - 10				9 - 13			13 - 18			5			
Operation range of coils		0,85 - 1,1				0,85 - 1,1			0,85 - 1,1			0,85 - 1,1			
Mounting		35mm DIN-rail or base										2x DIN-rail or base			
Additional aux. contact blocks		HN10 1NO f. low level switching		HN01 1NC f. low level switching		HA10 1NO 25A I _{th}		HA01 1NC 25A I _{th}		max. 4 HN.. or 4 HA..		max. 7 HN.. or 7 HA..			
Additional aux. contact blocks		HB11-1 1NO+1NC f. low level switching		max. 2 HB..		HB11 1NO+1NC f. low level switching		HB02 2NC f. low level switching		max. 2 HB..					
Overload Relay (thermal)															
Type		U3/32				U3/42				U3/74				U85	
		U12/16..K3				U3/42									
Number of Setting Ranges from		16 0,12 - 30A		16 0,12 - 32A		4 10 - 42A		5 20 - 74A		2 60 - 120A					
Busbar sets		-				-				-				-	



150A	175A	210A	260A	315A	450A	550A	700A	860A	1000A	1200A	
75kW 90kW	90kW 110kW	110kW 160kW	132kW 210kW	160kW 250kW	250kW 375kW	300kW 475kW	400kW 630kW	500kW 700kW	580kW 850kW	680kW 1000kW	
250A	300A	350A	450A	600A	700A	800A	1000A	1100A	1200A	1350A	
151A00	176A00	210A00	260A00	316A00	450A22	550A22	700A22	860A22	1000A12	1200A12	
-	-	-	-	-	2NO+2NC	2NO+2NC	2NO+2NC	2NO+2NC	1NO+2NC	1NO+2NC	
2 x 16-120 2 x 16-120		busbar 30x6	busbar 30x6	busbar 30x6	busbar 30x5	busbar 40x6	busbar 50x8	busbar 50x8	busbar 50x10	busbar 50x10	
- - -		- - -				10 3 2			10 3 2		
350 5 0,85 - 1,1	350 5	360 5	360 5 0,85 - 1,1	360 5	800-950 9-11	800-950 9-11	1350-1600 21-25 0,85 - 1,1	1350-1600 21-25	2400 70 0,85-1,1	2400 70	
base											
	HKT11 HKT22 1NO+1NC 2NO+2NC max. 1 pc.					HKF22 2NO+2NC max. 1 pc.				HKB11 1NO+1NC max. 2 pcs.	
	HKA11 1NO+1NC max. 2 pcs.				-	-	-	-	-	-	
											
U180	U320					U800					
1	2					3					
120 - 180A	144 - 320A					240 - 800A					
integrated	integrated					SU840/550		SU840/860			

Contactor, Motor-Starter

Circuit Breakers

Manual Motor-Starters

Switches

AC-Main Switches



DC-Switch Disconnect

Push Buttons

Representatives, Suppliers

Contactors 3-pole

AC Operated

Ratings		Rated Current	Aux. Contacts		Type	Coil voltage ¹⁾	Pack pcs.	Weight kg/pc.
AC2, AC3			Built-in	Additional see page 52				
380V								
400V	660V	AC1				24V 50/60Hz		
415V	690V	690V				110V 50/60Hz		
kW	kW	A	NO	NC	Typ	230V 50/60Hz		
						380-415V 50Hz		
						↓		
4	5,5	25	1	-	max. 4		1	0,23
4	5,5	25	-	1	HN.. or HA..		1	0,23
5,5	7,5	25	1	-	and 2 HB..		1	0,23
5,5	7,5	25	-	1			1	0,23
7,5	10	32	1	-			1	0,23
7,5	10	32	-	1			1	0,23
11	10	32	1	-			1	0,23
11	10	32	-	1			1	0,23
11	15	50	-	-	max. 4		1	0,48
15	18,5	65	-	-	HN.. or HA..		1	0,48
18,5	18,5	80	-	-	and 2 HB..		1	0,48
22	30	110	-	-	max. 4 (3) ⁴⁾		1	0,85
30	37	120	-	-	HN.. or HA..		1	0,85
37	45	130	-	-	and 2 HB..		1	0,85
45	55	160	-	-	max. 7		1	2,2
55	55	200	-	-	HN.. or HA.. and 2 HB..		1	2,2
75	110	250	-	-	1 HKT..		1	4
90	132	300	-	-	and 2 HKA11		1	4
110	160	350	-	-			1	7,2
132	210	450	-	-			1	7,2
160	250	600	-	-			1	7,2
250	375	700	2	2	1 HKF22		1	13
300	475	800	2	2			1	13,5
400	630	1000	2	2			1	26,5
500	700	1100	2	2			1	27,6
580	850	1200	1	2	2 HKB11		1	49
680	1000	1350	1	2			1	53

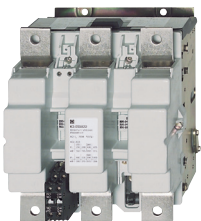

1) Coil voltage range and other coil voltages see page 57

2) Type for AC- and DC-operating: e.g.: 230: 220-240V 50/60Hz and 220V DC (with integrated coil suppressor)

3) Type 230VS for AC-operating 220-240V 50Hz (with integrated coil suppressor)

4) max. 3 HN.. or HA.. for DC-operated Contactors.

DC Operated

Type	Coil voltage ¹⁾		Coil power	Additional Overload Relay see page 114	W/W	Type	Pack pcs.	Weight kg/pc.
	24	48						
	24V DC	48V DC						
	110V DC	110V DC	inrush/hold					
	220	110V DC						

Wiring Diagram

Coil Circuits see page 53

Terminal Markings



KG3-10A10 ... ⁵⁾	3/3	U3/32	1	0,53
KG3-10A01 ... ⁵⁾	3/3	U12/16E U12/16EQ	1	0,53
KG3-14A10 ... ⁵⁾	3/3	UAT21	1	0,53
KG3-14A01 ... ⁵⁾	3/3		1	0,53
KG3-18A10 ... ⁵⁾	3/3		1	0,53
KG3-18A01 ... ⁵⁾	3/3		1	0,53
KG3-22A10 ... ⁵⁾	3/3		1	0,53
KG3-22A01 ... ⁵⁾	3/3		1	0,53

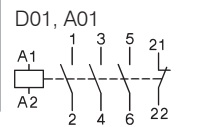
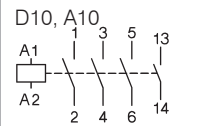

KG3-24A00 ... ⁵⁾	4/4	U3/32	1	0,57
KG3-32A00 ... ⁵⁾	4/4	U3/42	1	0,57
KG3-40A00 ... ⁵⁾	4/4	UAT..	1	0,57

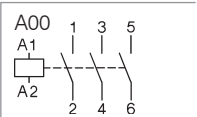

K3-50A00= ...	200/6	U3/74	1	0,9
K3-62A00= ...	200/6		1	0,9
K3-74A00= ...	200/6		1	0,9

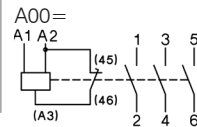

K3-90A00 ... ²⁾	280/5	U85	1	2,2
K3-115A00 ... ²⁾	280/5		1	2,3

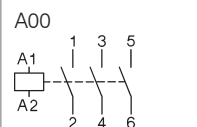

K3-151A00 ... ²⁾	350/5	U180	1	4
K3-176A00 ... ²⁾	350/5		1	4



K3-210A00 ... ²⁾	360/5	U320	1	7,2
K3-260A00 ... ²⁾	360/5		1	7,2
K3-316A00 ... ²⁾	360/5		1	7,2

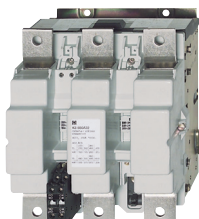

K3-450A22 ... ²⁾	800/10	U800	1	13
K3-550A22 ... ²⁾	800/10	+SU840/550	1	13,5

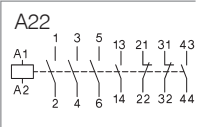

K3-700A22 ... ²⁾	1500/20	U800	1	26,5
K3-860A22 ... ²⁾	1500/20	+SU840/860	1	27,6

K3-1000A12= ...	2100/60		1	49
K3-1200A12= ...	2100/60		1	53

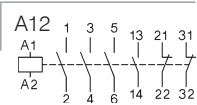

1) Other coil voltages on request

2) Type for AC- and DC-operating: e.g.: 24: 24V 50/60Hz and 24V DC (with integrated coil suppressor)

5) with integrated coil suppressor

Contactors 3-pole

DC operated with dual-wound coil



Ratings		Rated Current	Aux. Contacts		Type	Coil voltage ¹⁾	Pack pcs.	Weight kg/pc.
AC2	AC3		Built-in	Additional see page 52				
380V		AC1				24 24V= DC		
400V	660V	690V	NO	NC	Type	48 48V= DC		
415V	690V					110 110V= DC		
kW	kW	A				220 220V= DC		
4	5,5	25	1	-	max. 3		1	0,25
4	5,5	25	-	1	HN.. or HA..		1	0,25
5,5	7,5	25	1	-	and 2 HB..		1	0,25
5,5	7,5	25	-	1			1	0,25
7,5	10	32	1	-			1	0,25
7,5	10	32	-	1			1	0,25
11	10	32	1	-			1	0,25
11	10	32	-	1			1	0,25
11	15	50	-	-	max. 3		1	0,55
15	18,5	65	-	-	HN.. or HA..		1	0,55
18,5	18,5	80	-	-	and 2 HB..		1	0,55

Wiring Diagram

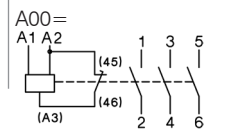
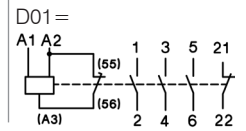
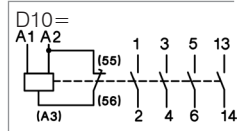

Contactors 4-pole

AC or DC operated



Ratings		Rated Current	Aux. Contacts		Type	Coil voltage ²⁾	Pack pcs.	Weight kg/pc.
AC2	AC1		Built-in	Additional see page 52				
380V		AC1				24 24V 50/60Hz		
400V		690V	NO	NC	Type	110 110V 50/60Hz		
415V	400V					230 220-240V 50Hz		
kW	kW	A				400 380-415V 50Hz		
						= 24 24V= DC ³⁾		
4	17,5	25	-	-	max. 4 ³⁾		1	0,23
4	17,5	25	-	-	HN.. or HA..		1	0,23
4	17,5	25	-	-	and 2 HB..		1	0,23
5,5	17,5	25	-	-			1	0,23
5,5	17,5	25	-	-			1	0,23
5,5	17,5	25	-	-			1	0,23
7,5	22	32	-	-			1	0,23
7,5	22	32	-	-			1	0,23
7,5	22	32	-	-			1	0,23
11	22	32	-	-			1	0,23
11	31	45	-	-	max. 4		1	0,65
15	34,5	50	-	-	HN..		1	0,65
18,5	34,5	50	-	-	or HA..		1	0,65
22	62	110	-	-	max. 6 ⁵⁾		1	1,1
30	69	120	-	-	HN.. or HA..		1	1,1
37	76	130	-	-	and 2 HB..		1	1,1
15	43	63	-	-	1 HKT.		1	1,4
15	43	63	-	-	+		1	1,4
					2 HKA11			
30	85	125	-	-			1	2,42
30	85	125	-	-			1	2,42
45	94	135	-	-			1	2,42
55	139	200	-	-			1	4,7
75	173	250	-	-			1	4,7
90	208	300	-	-			1	4,7
110	242	350	-	-			1	8
132	310	450	-	-			1	8
160	415	600	-	-			1	8

Wiring Diagram

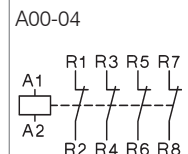
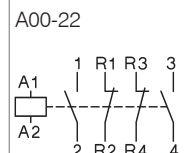
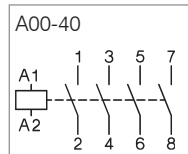

1) Other coil voltages on request

2) Coil voltage range and non-standard coil voltages see page 57

3) DC operated with dual-wound coil, max. 3 additional aux. contacts

4) with integrated coil suppressor (AC/DC coil)

5) DC operated with dual-wound coil, max. 5 additional aux. contacts

Capacitor Switching Contactors

for use with reactive or non-reactive capacitor banks



Rated Operational Power at 50/60Hz

Ambient Temperature

50°C		60°C	
380V	415V	660V	380V
400V	440V	690V	400V
kVAr	kVAr	kVAr	kVAr

Aux. Contacts
Built-in Add.
NO NC pcs.

Type

Coil voltage ¹⁾
220-240V 50Hz
Pack Weight
pcs. kg/pc.

0-12,5	0-13	0-20	0-12,5	0-13	0-20	1	-	1 ²⁾	K3-18NK10 ...	1	0,34
0-12,5	0-13	0-20	0-12,5	0-13	0-20	-	1	1 ²⁾	K3-18NK01 ...	1	0,34
0-12,5	0-13	0-20	0-12,5	0-13	0-20	1	-	1 ²⁾	K3-18NBK10 ...	1	0,40
10-20	10,5-22	17-33	10-20	10,5-22	17-33	-	-	3 ³⁾	K3-24K00 ...	1	0,62
10-25	10,5-27	17-41	10-25	10,5-27	17-41	-	-	3 ³⁾	K3-32K00 ...	1	0,62
20-33,3	23-36	36-55	20-33,3	23-36	36-55	-	-	3 ³⁾	K3-50K00 ...	1	1,0
20-50	23-53	36-82	20-50	23-53	36-82	-	-	3 ³⁾	K3-62K00 ...	1	1,0
20-75 ⁴⁾	23-75 ⁴⁾	36-120 ⁴⁾	20-60	23-64	36-100	-	-	3 ³⁾	K3-74K00 ...	1	1,0
33-80	36-82	57-120	33-75	36-77	57-120	-	-	6 ⁵⁾	K3-90K00 ... / VS ⁷⁾	1	2,3
33-100 ⁶⁾	36-103 ⁶⁾	57-148 ⁶⁾	33-90 ⁶⁾	36-93 ⁶⁾	57-148 ⁶⁾	-	-	6 ⁵⁾	K3-115K00 ... / VS ⁷⁾	1	2,3

Specification: Contactors K3-..K are suitable for switching low-inductive and low loss capacitors in capacitor banks (IEC70 and 831, VDE 0560) without and with reactors.

Capacitor switching contactors are fitted with early make contacts and damping resistors, to reduce the value of make current <70 x I_e.

Operating Conditions: Capacitor switching contactors are protected against contact welding for a prospective making current of 200 x I_e.

Technical Data acc. to IEC 947-4-1, IEC 947-5-1, EN 60947-4-1, EN 60947-5-1, VDE 0660

Type		K3-18NK	K3-18NBK ⁸⁾	K3-24K	K3-32K	K3-50K	K3-62K	K3-74K	K3-90K	K3-115K
Max. frequency of operations z	1/h	120	120	120	120	120	120	80	80	80
Contact life non reactive cap. banks S x 10 ³		250	250	150	150	150	150	120	120	120
	reactive cap. banks S x 10 ³	400	400	300	300	300	300	200	200	200
Rated operational current I_e	at 50°C A	0-18	0-18	14-28	14-36	30-48	30-72	30-108	50-115	50-144
	at 60°C A	0-18	0-18	14-28	14-36	30-48	30-72	30-87	50-108	50-130
Rated operational current I _{th}	at 50°C A	32	45	45	60	100	110	120	155	190
	AC1 at 60°C A	32	40	40	55	90	100	110	145	170
Overload factor acc. to EN 61921: 30% min.	at 50°C %	78	150	60	67	108	53	11	35	32
	at 60°C %	78	122	43	53	88	39	26	34	31
Fuses gL (gG)	from / to A	35 / 63	35 / 63	50 / 80	63 / 100	80 / 160	125 / 160	160/200	160/200	160/250

Typical Circuit Diagram

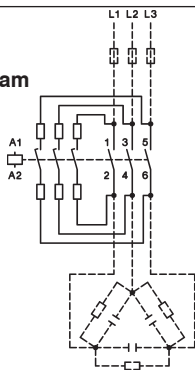

Wiring Diagram for Quick Discharge Resistors

Make sure that the current of the discharge resistors is not higher than the rated current (AC1) of the auxiliary contacts

Mounting instructions:

In the area of capacitor switching contactors, difficulty inflammable and self-extinguishing materials shall be used only, because abnormal temperatures within the area of the resistor spirals cannot be excluded.

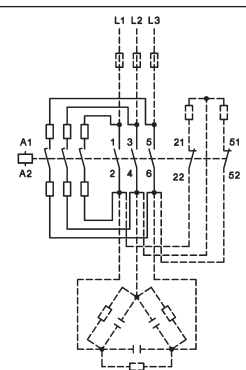

- 1) Coil voltage range and non-standard coil voltages see page 57
- 2) 1 HN.. or HA.. snap-on
- 3) 2HB.. for side mounting and 1 HN.. or HA.. snap-on
- 4) Consider the max. thermal current of the contactor K3-74A: I_{th} 130A
- 5) 2 HB.. on the left or right side and 4 HN.. or HA.. snap-on
- 6) Consider the min. cross-section of conductor at max. load
- 7) Type 230 for AC- and DC-operating 220-240V 50/60Hz and 220V DC (with integrated coil suppressor)
Type 230VS for AC-operating 220-240V 50Hz (with integrated coil suppressor)
- 8) Cable cross sections: 2,5 - 16mm²

Auxiliary Contact Blocks for contactors K(G)3-07.. to K3-115.., type HN.. for low level switching ¹⁾



Rated Operational Current			Contacts				Type	Pack pcs.	Weight kg/pc.
AC15 230V A	AC15 400V A	AC1 690V A	NO	NC	EM	LB			
3	2	10	1	-	-	-	HN10	10	0,02
3	2	10	-	1	-	-	HN01	10	0,02
3	2	10	-	-	1	-	HN10U	10	0,02
3	2	10	-	-	-	1	HN01U	10	0,02
6	3	25	1	-	-	-	HA10	10	0,03
6	3	25	-	1	-	-	HA01	10	0,03

Auxiliary Contact Blocks for contactors K3-.., for low level switching ^{1) 3)}



Rated Operational Current			mounting: 1 HB.. on left side and 1 HB.. on right side	Contacts		Type	Pack pcs.	Weight kg/pc.
AC15 230V A	AC15 400V A	AC1 690V A		NO	NC			
3	2	10	for K3-10 to K3-22	1	1	HB11-1	10	0,02
3	2	10	for K3-24 to K3-115	1	1	HB11	10	0,02
3	2	10	for K3-24 to K3-115	-	2	HB02	10	0,02

Auxiliary Contact Blocks for contactors K3-41.., K3-96.., K3-116.. to K3-1200.., for low level switching ¹⁾



Rated Operational Current			For contactors	Contacts		Type	Pack pcs.	Weight kg/pc.
AC15 230V A	AC15 400V A	AC1 690V A		NO	NC			
3	2	10	K3-116 to K3-316 top	1	1	HKT11	1	0,04
3	2	10	K3-116 to K3-316 top	2	2	HKT22	1	0,05
3	2	10	K3-116 to K3-316 outside	1	1	HKA11	1	0,05
6	3	16	K3-200 to K3-860 ²⁾	2 ²⁾	2	HKF22	1	0,12
6	3	16	K3-1000, K3-1200 inside	1	1	HKB11	1	0,17

Snap-on Momentary Contacts for K(G)3-07.. to K3-115.. for low level switching ¹⁾



Rated Operational Current			Specification	Contacts		Type	Pack pcs.	Weight kg/pc.
AC15 230V A	AC15 400V A	AC1 690V A		NO	NC			
3	2	10	manual operated	1	-	HTN10	10	0,02
3	2	10	manual operated	-	1	HTN01	10	0,02

Terminal Blocks for contactors K(G)3-07.. to K3-115.. and K2-..



Specification	Thermal Current I _{th} A	Type	Pack pcs.	Weight kg/pc.
2 terminals interconnected	26	K2-DK	10	0,02
2 terminals insulated	26	K2-SK	10	0,02

1) Contacts suitable for electronic circuits, according to IEC60947-5-4 for rated voltage 24V DC (test ratings 17V DC, 5mA) Mirror contacts acc. IEC60947-4-1 Annex F. Technical data see page 80.

2) Contact travel of make contacts adjustable, see page 81.

3) Except K3-41A00.. and K3-96A00..

Electronic Timer

for mounting on DIN-rail, Control voltage 24-240V AC/DC, 1 changeover contact
 OFF-delay without auxiliary voltage
 Replace Pneumatic Timer K2-TP. and K2-TA



5 Functions in one device	4 Time ranges in one device s	Rated Current AC1 250V A	Type	Pack pcs.	Weight kg/pc.
ON-delay, OFF-delay, Single shot trailing edge, Single shot leading edge, Single shot leading and trailing edge	0,1 - 1, 1 - 10, 6 - 60 a, 18 - 180	5	K3-T180 240	1	0,085

Electronic Timer On-delay for contactors K(G)3-07.. to K3-115.. and K2-..

Timer will be connected with the contactor coil, can be snapped onto the contactor and occupies 2 add-on spaces. Contactor switches On-delay.



Operational Voltage V	Time Range s	Rated Current AC15 A	Type	Pack pcs.	Weight kg/pc.
24 - 60V AC/DC	1 - 30	0,75	K2-TE30 60	1	0,08
100 - 250V AC/DC	1 - 30	0,75	K2-TE30 250	1	0,08
24 - 60V AC/DC	10 - 180	0,75	K2-TE180 60	1	0,08
100 - 250V AC/DC	10 - 180	0,75	K2-TE180 250	1	0,08
24 - 60V AC/DC	30 - 600	0,75	K2-TE600 60	1	0,08
100 - 250V AC/DC	30 - 600	0,75	K2-TE600 250	1	0,08

Wiring Diagram

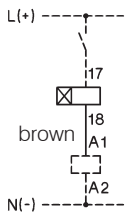

Timing Chart

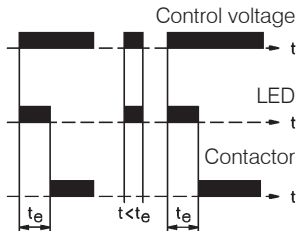

Operation Range

Time repeat accuracy
 Recovery time (typical)

$0,8 - 1,1 \times U_s$
 $\leq 1\%$
 50ms

Voltage Drop after the time delay t_e
 (Control voltage 24V: use contactor with 20V-coil)
 Max. inrush current (peak value)

<3V
 25A <10ms

Duty Cycle

Ambient temperature
 Short circuit protection

100%
 $-40^\circ - +60^\circ\text{C}$
 2A

Latch for contactors K(G)3-07.. to K3-74.. and K2-..

with NC aux. contact
duty cycle 10%, max. 30 sec. AC / max. 20 sec. DC
power consumption max. 35VA



For Contactors

	Type	Pack pcs.	Weight kg/pc.
K3-07 to K3-22, K2-07 to K2-16	K2-L22 . . .	1	0,08
K3-24 to K3-40, K2-23 to K2-37, KG3-10 to KG3-40	K2-L40 . . .	1	0,08
K3-50 to K3-74, K2-45 to K2-60	K2-L74 . . .	1	0,08

Technical data see page 74

Latch / Magnetic latch for Contactors K3-151 to K3-1200 on request

Type	Coil voltage
24	22-26V 50/60Hz
110	100-120V 50/60Hz
230	210 -250V 50/60Hz
400	360-440V 50/60Hz



Indicator Units for contactors K(G)3-07.. to K3-115.. and K2-..



Specifications	Voltage Range	Type	Pack pcs.	Weight kg/pc.
Coil Current Indicator , green (LED)	24 - 660V AC/DC	K2-ING	10	0,02
Coil Current Indicator , red (LED)	24 - 660V AC/DC	K2-INR	10	0,02
To connect in series with the contactor coil. In case of coil interruption the indication goes out. Voltage drop appr. 2 volts				
Voltage Indicator , clear (glow-disc. I.)	220 - 415V AC/DC	K2-UN	10	0,02
Voltage Indicator , red (LED)	24 - 120V AC/DC	K2-UNR	10	0,02
To connect parallel to the contactor coil. In case of applied voltage the indication also lights at coil interruption.				

Snap-On Adapter



For Type	Specification	Type	Pack pcs.	Weight kg/pc.
K2-DK, K2-SK, K2-TE, K2-TA K2-F, K2-RF K2-IN., K2-UN.	for snap-on mounting of accessories on 35mm DIN-rail acc. DIN EN 50022	K2-SM	10	0,009

Additional 4th Poles for contactors K3-315.. to K3-1200



For Contactors	Thermal Current I_{th} A	Type	Pack pcs.	Weight kg/pc.
K3-315, K3-450, K3-550	325	NP325	1	0,7
K3-315, K3-450, K3-550	500	NP500	1	1,3
K3-450, K3-550	760	NP760	1	1,4
K3-700, K3-860	500	NP501	1	1,3
K3-700, K3-860	1000	NP1000	1	1,6
K3-1000, K3-1200	1000	NP1001	1	1,6

Mechanical Interlocks



Interlocks contactor with contactor Type	Type	Mounting	Type	Pack pcs.	Weight kg/pc.
K3-07 to K3-40 KG3-07 to KG3-22 KG3-24 to KG3-40 K2-07 to K2-37	K3-07 to K3-40 KG3-07 to KG3-22 KG3-24 to KG3-40 K2-07 to K2-37	horizontal	LG10889 ¹⁾	10	0,006
K3-24 to K3-74 K2-23 to K2-60	K3-50 to K3-74 K2-45 to K2-60	horizontal	LG10890 ¹⁾	1	0,010
K3-90, K3-115	K3-90, K3-115	horizontal	LG11478 ¹⁾	1	0,010
K65 to K110	K65 to K110	horizontal	LG8511	1	0,076
K3-116 to K3-316	K3-116 to K3-316	horizontal	LG11223H	1	0,06
K3-315 to K3-550	K3-315 to K3-550	horizontal	LG10400H	1	0,8
K3-315 to K3-550	K3-315 to K3-550	vertical	LG10400V	1	0,8
K3-450, K3-550	K3-700, K3-860	horizontal	LG10399H	1	1,6
K3-450, K3-550	K3-700, K3-860	vertical	LG10399V	1	0,9
K3-700, K3-860	K3-700, K3-860	horizontal	LG10402H	1	1,5
K3-700, K3-860	K3-700, K3-860	vertical	LG10402V	1	0,9
K3-700, K3-860	K3-1000, K3-1200	horizontal	LG10401H	1	1,9
K3-700, K3-860	K3-1000, K3-1200	vertical	LG10401V	1	1,6
K3-1000, K3-1200	K3-1000, K3-1200	horizontal	LG10403H	1	1,8
K3-1000, K3-1200	K3-1000, K3-1200	vertical	LG10403V	1	1,5

1) clamps for mounting incl.

Terminal Covers for terminal protection according to DIN 57106, VBG 4



For Contactors	Specification	Type	Pack pcs.	Weight kg/pc.
K65 to K110 (spare part)	for 6 terminals	LG9333	1	0,045
K3-151, K3-176	3-pole for 3 terminals	LG10404	1	0,12
K3-116 to K3-176	4-pole for 4 terminals	LG104044	1	0,14
K3-210, K3-260, K3-316	for 3 terminals	LG11457	1	0,14
K3-200	for 3 terminals	LG10405	1	0,18
K3-315, K3-450	for 3 terminals	LG10406	1	0,28
K3-550	for 3 terminals	LG10407	1	0,34
K3-700	for 3 terminals	LG10408	1	0,39
K3-860	for 3 terminals	LG10409	1	0,49

Additional Terminals



For Contactors	Cable Cross-sections to clamp mm ² solid or stranded	flexible	flex. with multi- core cable end	Type	Pack pcs.	Weight kg/pc.
Additional Terminal Single Pole, with fingertouch protection						
K(G)3-10 to K(G)3-22	0,75 - 10	0,75 - 6	0,75 - 6	LG9339N	6	0,009
K2-09 to K2-16						
K3-151 to K3-176		16 - 120	+ 16 - 95	LG11224	1	0,10

1) Inclusively mounting clamps

Parallel Connectors

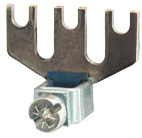

For Contactors	Cable Cross-sections to clamp mm ² solid or stranded	flexible	flex. with multi- core cable end	Type	Pack pcs.	Weight kg/pc.
----------------	---	----------	-------------------------------------	------	--------------	------------------

Parallel Connectors, 3 Poles Parallel

Current-carrying capacity: 2,5 x AC1-value of the contactor

K(G)3-10 to K(G)3-22	terminal hole for screw M5			LG9241	50	0,004
K2-09 to K2-16						
K2-23 to K2-37	4 - 35	6 - 25	4 - 25	LG5587	10	0,022

Parallel Connectors, 4 Poles Parallel

Current-carrying capacity: 3,2 x AC1-value of the contactor

K(G)3-10 to K(G)3-22	terminal hole for screw M5			LG7360	10	0,006
K2-09 to K2-16						

Suppressor Units



Voltage Range V	Mounting		Type	Pack pcs.	Weight kg/pc.
--------------------	----------	--	------	--------------	------------------

RC-units for contactors K3-07 - K3-74

12 - 48V AC/DC	to snap	1600nF / 22 Ohm	RC-K3N 24	10	0,01
48 - 127V AC/DC	on the	680nF / 270 Ohm	RC-K3N 110	10	0,01
110 - 230V AC/DC	contactor	220nF / 2200 Ohm	RC-K3N 230	10	0,01
230 - 415V AC/DC		120nF / 620 Ohm	RC-K3N 400	10	0,01

RC-units for contactors K3-07 - K3-74 and reversing contactors K3NWU10 - K3WU74

12 - 48V AC/DC	to snap	1600nF / 22 Ohm	RC-K3NW 24	10	0,01
48 - 127V AC/DC	on the	680nF / 270 Ohm	RC-K3NW 110	10	0,01
110 - 230V AC/DC	contactor	220nF / 2200 Ohm	RC-K3NW 230	10	0,01
230 - 415V AC/DC		120nF / 620 Ohm	RC-K3NW 400	10	0,01

Mounting Parts



Description	For Type	Specification	Type	Pack pcs.	Weight kg/pc.
-------------	----------	---------------	------	--------------	------------------

Clamp, no distance	K3-07 to K3-115 K2-07 to K2-37	To join contactors without distance, 2 pieces required	P426-1	50	0,001
-------------------------------	-----------------------------------	--	---------------	----	-------



Clamp, 7mm distance	K3-07 to K3-115 K2-07 to K2-37	To join contactors with 7mm distance, 2 pieces required	P418-1	10	0,002
--------------------------------	-----------------------------------	---	---------------	----	-------

Clamp, 12mm distance	K3-07 to K3-115 K2-07 to K2-37	To join contactors with 12mm distance, 2 pieces required	P807-1	10	0,002
---------------------------------	-----------------------------------	--	---------------	----	-------

Clamp asymmetric	K3-07 to K3-40 with K3-50 to K3-74	To join contactors with 12mm distance, 2 pieces required	P785-1	10	0,002
-----------------------------	---------------------------------------	--	---------------	----	-------



Retention clamp	K3-10 to K3-74	To close contactors	P725		
------------------------	----------------	---------------------	-------------	--	--

Marking System for contactors K3-07.. to K3-115.., K2-.. and aux. contact blocks HN and HA



Description	Specification	Type	Pack pcs.	Weight kg/100pc
-------------	---------------	------	--------------	--------------------

Marking Plate	2-section without marking, divisible	P487-1	100	0,025
----------------------	--------------------------------------	---------------	-----	-------

Marking Plate	3-section without marking, divisible	P971-1	100	0,038
----------------------	--------------------------------------	---------------	-----	-------

Marking Plate	4-section without marking, divisible	P245-1	100	0,050
----------------------	--------------------------------------	---------------	-----	-------

Marking Plate	marked, choice of K1...K32	P245-K..	100	0,013
----------------------	----------------------------	-----------------	-----	-------

Coil voltages for AC operated contactors

Type-suffix for coil-types K6/.. to K45/...
for contactor-types K3-07.. to K3-74

Suffix to contactor type	to coil type	Voltage Marking at the coil		Rated Control Voltage U _s range			
		for 50Hz V	for 60Hz V	for 50Hz min. V	max. V	for 60Hz min. V	max. V
6	41.6	6		6	6,6	6,6	7,3
6,6	41.6,6	6,6		6,6	7,3	7,3	8
7,3	41.7,3	7,3		7,3	8	8	9
8	41.8	8		8	9	9	10
9	41.9	9		9	10	10	11
10	41.10	10		10	11	11	12
11	41.11	11	12	11	12	12	13,2
12	41.12	12		12	13,2	13,2	14,5
13,2	41.13	13,2		13,2	14,5	14,5	16
14,5	41.14	14,5		14,5	16	16	18
16	41.16	16		16	18	18	20
18	41.18	18		18	20	20	22
20	41.20	20		20	22	22	24
24	4.24	24	24	22	24	24	27
25	41.25	25		24	27	27	30
27	41.27	27	32	27	30	30	33
32	41.32	32	36	30	33	33	36
33	41.33	36	36	33	36	36	39
36	41.36	36	42	36	39	39	42
40	41.40	42	42	39	42	42	47
42	4.42	42	48	42	47	47	52
48	41.48	48	48	44	48	48	52
55	41.55	55	60	52	58	58	65
60	41.60	60		58	65	65	72
65	41.65	65		65	72	72	80
75	41.75	75		72	80	80	90
85	41.85	85		80	90	90	100
90	41.90	100	100	90	100	100	110
110	4.110	110	110-120	100	110	110	122
115	41.115	115	125	110	122	122	135
127	41.127	127		122	135	135	150
140	41.140	140		135	150	150	165
150	41.150	150		150	165	165	180
165	41.165	165	180-208	165	180	180	208
180	41.180	180-210 ¹⁾	200-240 ¹⁾	180	210 ¹⁾	200	240 ¹⁾
190R ²⁾	41.190	200-240	200-240	200	240	200	240
200	41.200	200-230 ¹⁾	220-240	200	230 ¹⁾	220	240
230	4.230	220-240	230-264	220	240	230	264
254	41.254	254	277	240	264	264	290
270	41.270	270		264	290	290	315
300	41.300	300		290	315	315	345
320	41.320	320		315	345	345	380
345	41.345	345-400 ¹⁾	380-440 ¹⁾	345	400 ¹⁾	380	440 ¹⁾
390R ²⁾	41.390	400-480	400-480	400	480	400	480
400	4.400	380-415	400-440	380	415	400	460
415	41.415	415-440	440-480	400	440	440	480
440	41.440	440-480	480-500	440	480	480	530
480	41.480	480-500	530-580	480	530	530	580
500	41.500	500-550	550-600	500	550	550	600
550	41.550	550-600	600	550	600	600	(650)

Standard voltages in bold type letters.

- 1) Operating range of magnet-coils: 0,85 x U_s (min. value of rated control voltage) up to 1,05 x U_s (max. value of rated control voltage).
2) Reduction of mechanical life to 10% of normal life. It is not admissible as a spare coil in a contactor for different coil voltages.

Type-suffix for coil-types K85/... and K110/...
for contactor-types K85 to K110

Suffix to contactor type	to coil type	Voltage Marking at the coil		Rated Control Voltage U _s range			
		for 50Hz V	for 60Hz V	for 50Hz min. V	max. V	for 60Hz min. V	max. V
20	4.20	20	24	20	22	24	26
24	4.24	24		24	27	29	32
42	4.42	42		42	47	50	56
110	4.110	110-120		110	122	132	146
230	4.230	220-240	277	220	240	264	288
400	4.400	380-415	460-480	380	415	455	498

Type-suffix for coil-types K3-1200/...
for contactor-types K3-1000.. to K3-1200..

110	4.110	110-115	-	110	115	110	115
230	4.230	220-230	-	220	230	220	230
400	4.400	380-400	-	380	400	380	400
440	4.440	440	-	440	440	440	440

Coil voltages for AC and DC operated contactors

Type-suffix for coil-types K3-115/.. to K3-860/...
for contactor-types K3-90.. to K3-860..

Suffix to contactor type	to coil type	Voltage Marking at the coil		Rated Control Voltage U _s range			
		for 50/60Hz V	for DC V	for 50Hz min. V	max. V	for 60Hz min. V	max. V
24	4.24	24	24	22	24	22	24
48	4.48	48	48	44	48	44	48
110	4.110	110-120	110	110	120	110	120
230	4.230	220-240	220	220	240	220	240
400	4.400	380-415	-	380	415	380	415

Coil voltages for AC operated contactors

Type-suffix for coil-types K3-115/..AC
for contactor-types K3-90..AC to K3-115..AC

Suffix to contactor type	to coil type	Voltage Marking at the coil		Rated Control Voltage U _s range			
		for 50Hz V	for 60Hz V	for 50Hz min. V	max. V	for 60Hz min. V	max. V
110AC	4.110AC	110-122	132-146	110	122	132	146
230AC	4.230AC	220-240	277	220	240	264	288

Other coil voltages on request

Operating range of magnet-coils: 0,85 x U_s (min. value of rated control voltage) up to 1,1 x U_s (max. value of rated control voltage)

With reduced control voltage range 0,9 up to 1,0 x U_s at ambient temperature 60 - 90°C

Spare Coils for AC operated contactors



		Type	Coil voltage ¹⁾	Pack pcs.	Weight kg/pc.
For Contactors		4.24	24V 50Hz		
		4.42	42V 50Hz		
		4.110	110V 50Hz		
		41.180	180V 50Hz, 220V 60Hz		
		4.230	220-240V 50Hz		
		4.400	380-415V 50Hz		
		↓			
K3-07N.. up to K3-22N..		K10N/ ...EUR		1	0,053
K3-07.. up to K3-22..		K3-6/ ...		10	0,040
K2-07.. up to K2-16..		K6/ ...		10	0,040
K3-24.. up to K3-40..		K24/ ...		1	0,085
K2-23.. up to K2-37..		K23/ ...		1	0,085
K3-50.. up to K3-74..	3 pole contactor	K45/ ...		1	0,110
K3-50.. up to K3-74..	4 pole contactor	K50/ ...		1	0,110
K85.., K110..		K110/ ...		1	0,220
K3-90.., K3-115.. (AC/DC coil)		K115/ ...		1	0,230
		Type	Coil voltage ¹⁾		
		4.110	110V 50Hz, 110-115V 60Hz		
		4.230	220-230V 50Hz		
		4.400	380-400V 50Hz		
		↓			
K3-150.., K3-175..		K3-175/ ...		1	0,38
K3-1000.., K3-1200..	without feeder group ²⁾	K3-1200/ ...		1	3,12

Spare Coils for AC and DC operated contactors



		Type	Coil voltage ¹⁾	Pack pcs.	Weight kg/pc.
For Contactors		4.24	24V 50/60Hz / 24V DC		
		4.110	110-120V 50/60Hz / 110V DC		
		4.230	220-240V 50/60Hz / 220V DC		
		4.400	380-415V 50/60Hz		
		↓			
K3-90.., K3-115..	with feeder group	K3-115/ ...		1	0,30
K3-151.., K3-176..	with feeder group	K3-176/ ...		1	0,68
K3-210.., K3-316..	with feeder group	K3-316/ ...		1	0,68
K3-450.., K3-550..	without feeder group ²⁾	K3-550/ ...		1	1,63
K3-700.., K3-860..	without feeder group ²⁾	K3-860/ ...		1	2,44

Spare Feeder Groups for contactors K3-450.. to K3-860..

In case of changing control voltage, change coil and feeder group too

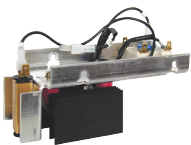

		Type	Coil voltage ¹⁾	Pack pcs.	Weight kg/pc.
For Contactors		110	110-120V 50/60Hz / 110V DC		
		230	220-240V 50/60Hz / 220V DC		
		400	380-415V 50/60Hz		
		↓			
K3-450.., K3-550..	K3-550/4...	K3-550/FG ...		1	0,33
K3-700.., K3-860..	K3-860/4..	K3-860/FG ...		1	0,54

1) Coil voltage range and non-standard coil voltages see page 57

2) In case of changing control voltage, change coil and feeder group too

Spare Coils for DC operated contactors

Aux. Contact Block
for dual-wound coil

Type	Coil voltage ¹⁾
47.24	24V DC
47.48	48V DC
47.110	110V DC
47.220	220V DC

For Contactors

For Contactors	Aux. Contact Block for dual-wound coil	Type	Pack pcs.	Weight kg/pc.
K3-07N..= up to K3-22N..=	HN01U	K10N/ ...	1	0,052
K3-07..= up to K3-22..=	HN01U	K3-6/ ...	1	0,042
K2-07..= up to K2-16..=	HN01U	K6/ ...	1	0,042
K3-24..= up to K3-40..=	HN01X	K24/ ...	1	0,090
K2-23..= up to K2-37..=	HN01X	K23/ ...	1	0,090
K3-50..= up to K3-74..=	HN01Z	K45/ ...	1	0,115
K3-50..= up to K3-74..=	HN01Z	K50/ ...	1	0,115
K85.., K110..=	-	K110/ ...	1	0,225
K3-90.., K3-115.. (AC/DC coil)	-	see page 58	1	0,230



Type	Coil voltage ¹⁾
43.110	110V DC
43.220	220V DC

For Contactors

For Contactors	Aux. Contact Block for dual-wound coil	Type	Pack pcs.	Weight kg/pc.
K3-1000.., K3-1200..=	without feeder group ²⁾	K3-1200/ ...	1	3,12

Wiring Diagrams for Coil Circuit

AC operated,

K3-07..
up to **K110..**



DC operated
with dual-wound coil

K3-07..=
up to **K3-22..=**

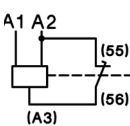

DC operated

KG3..

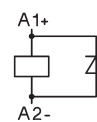

AC and DC operated
with dual-wound coil
K3-90A00, K3-115A00
K3-151A00, K3-176A00
K3-210A00 to K3-316A00

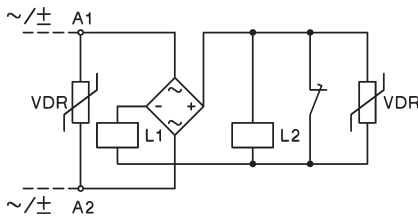

K3-24..=
to
K3-74..=

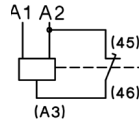

AC and DC operated
with series resistor
K3-200A21
K3-315A21

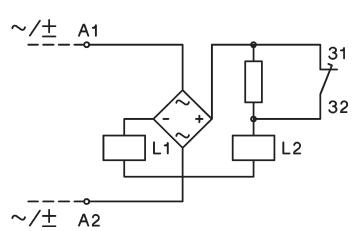

AC and DC operated
with series resistor
K3-450.. up to **K3-860..**

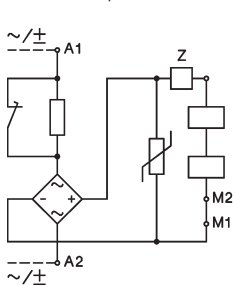

DC operated
with DC coil
K3-1000.., K3-1200..

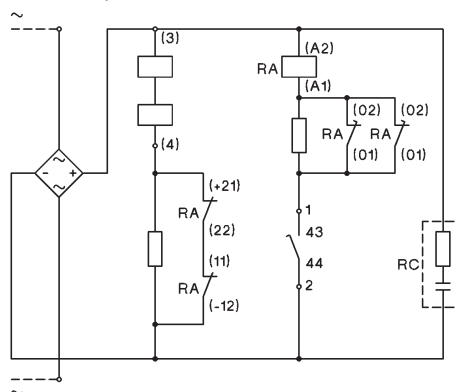

AC operated
with DC coil
K3-1000.., K3-1200..

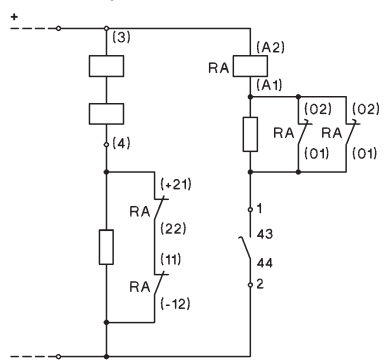

Adjustable dropout operating time for K3-450.. to K3-860..:
150-200ms: Wiring see above (delivery standard)
500-1000ms: Jumper device "Z"
approx. 20ms: Special wiring see package folder

Contactors K3-1000.., K3-1200..:
For control voltages up to 125V
NC contacts 21-22 and 11-12 are connected parallel,
for higher voltages contacts are connected in series (delivery standard).

1) Other coil voltages on request
2) In case of changing control voltage, change coil and feeder group too

Spare Contacts

Main Contacts for Contactors	Type	Pack pcs.	Weight kg/pc.
K85..	EK85/1	3	0,235
K110..	EK110/1	3	0,275
K3-150..	EK3-150/10	1	0,32
K3-151..	EK3-151/10	1	0,16
K3-175..	EK3-175/10	1	0,32
K3-176..	EK3-176/10	1	0,16
K3-200..	EK3-200/10	1	0,18
K3-210..	EK3-210/10	1	0,18
K3-260..	EK3-260/10	1	0,30
K3-315..	EK3-315/10	1	0,34
K3-316..	EK3-316/10	1	0,34
K3-450..	EK3-450/10	1	0,35
K3-550..	EK3-550/10	1	0,35
K3-700..	EK3-700/10	1	0,85
K3-860..	EK3-860/10	1	1,0
K3-1000..	EK3-1000/10	1	1,4
K3-1200..	EK3-1200/10	1	1,4

Contactors

Data according to IEC 947-4-1, EN 60947-4-1, VDE 0660

Main Contacts	Type	K(G)3-10	K(G)3-14	K(G)3-18	K(G)3-22	K(G)3-24	K(G)3-32	K(G)3-40	K3-50	K3-62	K3-74
Rated insulation voltage U_i ¹⁾	V AC	690	690	690	690	690	690	690	830	830	830
Making capacity I_{eff} at $U_e = 690V$ AC	A	200	200	200	200	400	500	500	700	900	900
	1000V AC	-	-	-	-	-	-	-	-	-	-
Breaking capacity I_{eff} 400V AC	A	180	180	200	200	380	400	400	600	800	800
K3-10 to K3-22 $\cos\phi = 0,65$	A	150	150	180	180	300	370	370	500	700	700
K3-24 to K3-1200 $\cos\phi = 0,35$	A	100	100	150	150	260	340	340	400	500	500
	1000V AC	-	-	-	-	-	-	-	-	-	-
Utilization category AC1											
Switching of resistive load											
Rated operational current $I_e (=I_{th})$ at 40°C, open	690V A	25	25	32	32	50	65	80	110	120	130
Rated operational power of three-phase resistive loads 50-60Hz, $\cos\phi = 1$	220V kW	9,5	9,5	12,2	12,2	19,0	24,7	30,4	41,9	45,7	49,5
	230V kW	9,9	9,9	12,7	12,7	19,9	25,9	31,8	43,8	47,7	51,7
	240V kW	10,4	10,4	13,3	13,3	20,8	27,0	33,2	45,7	49,8	54,0
	380V kW	16,4	16,4	21,0	21,0	32,9	42,7	52,6	72,3	78,9	85,5
	400V kW	17,3	17,3	22,1	22,1	34,6	45,0	55,4	76,1	83,0	90,0
	415V kW	17,9	17,9	23,0	23,0	35,9	46,7	57,4	79,0	86,2	93,3
	440V kW	19,0	19,0	24,4	24,4	38,1	49,5	60,9	83,7	91,3	99,0
	500V kW	21,6	21,6	27,7	27,7	43,3	56,2	69,2	95,2	103,8	112,5
	660V kW	28,5	28,5	36,5	36,5	57,1	74,2	91,3	125,6	137,0	148,4
	690V kW	29,8	29,8	38,2	38,2	59,7	77,6	95,5	131,3	143,2	155,2
	1000V kW	-	-	-	-	-	-	-	-	-	-
Rated operational current $I_e (=I_{th})$ at 40°C, inside the enclosure 60°C	690V A	25	25	32	32	40	55	65	90	100	110
Rated operational power of three-phase resistive loads 50-60Hz, $\cos\phi = 1$	220V kW	9,5	9,5	12,2	12,2	15,2	20,9	24,7	34,3	38,1	41,9
	230V kW	9,9	9,9	12,7	12,7	15,9	21,9	25,9	35,8	39,8	43,8
	240V kW	10,4	10,4	13,3	13,3	16,6	22,8	27,0	37,4	41,5	45,7
	380V kW	16,4	16,4	21,0	21,0	26,3	36,2	42,7	59,2	65,7	72,3
	400V kW	17,3	17,3	22,1	22,1	27,7	38,1	45,0	62,3	69,2	76,1
	415V kW	17,9	17,9	23,0	23,0	28,7	39,5	46,7	64,6	71,8	79,0
	440V kW	19,0	19,0	24,4	24,4	30,4	41,9	49,5	68,5	76,1	83,7
	500V kW	21,6	21,6	27,7	27,7	34,6	47,6	56,2	77,9	86,5	95,2
	660V kW	28,5	28,5	36,5	36,5	45,7	62,8	74,2	102,8	114,2	125,6
	690V kW	29,8	29,8	38,2	38,2	47,7	65,7	77,6	107,4	119,4	131,3
	1000V kW	-	-	-	-	-	-	-	-	-	-
Minimum cross-section of conductor at load with $I_e (=I_{th})$	mm ²	4	4	6	6	10	16	25	35	50	50
Utilization category AC2 and AC3											
Switching of three-phase motors											
Rated operational current I_e open and enclosed	220V A	12	15	18	22	24	32	40	50	63	74
	230V A	11,5	14,5	18	22	24	32	40	50	62	74
	240V A	11	14	18	22	24	32	40	50	62	74
	380-400V A	10	14	18	22	24	32	40	50	62	74
	415V A	9	14	18	22	23	30	40	50	62	74
	440V A	9	14	18	22	23	30	40	50	62	74
	500V A	8,9	11,9	15	15	22,5	28,5	28,5	44	54	64,5
	660-690V A	6,7	9	12	12	17,5	21	21	33	42	49
	1000V A	-	-	-	-	-	-	-	-	-	-
Rated operational power of three-phase motors 50-60Hz	220-230V kW	3	4	5	6	6	8,5	11	12,5	18,5	22
	240V kW	3	4	5	7	7	9	11,5	13,5	19	23
	380-400V kW	4	5,5	7,5	11	11	15	18,5	22	30	37
	415V kW	4,5	6	8,5	12	12	16	20	24	33	40
	440V kW	4,5	6	8,5	12	12	16	20	24	33	40
	500V kW	5,5	7,5	10	10	15	18,5	18,5	30	37	45
	660-690V kW	5,5	7,5	10	10	15	18,5	18,5	30	37	45
	1000V kW	-	-	-	-	-	-	-	-	-	-

1) Suitable at 690V for: earthed-neutral systems, overvoltage category I to IV, pollution degree 3 (standard-industry): $U_{imp} = 8kV$.
Data for other conditions on request.

Contactors

Data according to IEC 947-4-1, EN 60947-4-1, VDE 0660

Type	K3-90	K3-115	K3-116	K3-151	K3-176	K3-210	K3-260	K3-316	K3-450	K3-550	K3-700	K3-860	K3-1000	K3-1200
V AC	1000	1000	1000	1000	1000	1000	1000	1000	1000	1000	690	690	690	690
A	1100	1200	1200	1500	2000	2100	2600	3200	4500	5500	7000	8600	10000	12000
A	540	600	600	720	840	1020	1200	1500	2400	3000	-	-	-	-
A	950	1100	1000	1200	1500	1600	2100	2600	4500	5500	7000	8000	8000	10000
A	850	1000	1000	1200	1500	1600	2100	2600	4500	5500	7000	8000	8000	10000
A	600	600	800	1000	800	1200	1900	2300	3200	4400	5600	6900	7000	8000
A	450	450	400	500	600	700	850	1000	-	-	-	-	-	-
A	160	200	200	250	300	350	450	600	700	800	1000	1100	1200	1350
kW	60	76	76	95	114	133	171	228	266	304	381	419	457	514
kW	63	79	79	99	119	139	179	238	279	318	398	438	478	537
kW	66	83	83	103	124	145	187	249	291	332	415	457	498	561
kW	105	131	131	165	197	230	296	394	460	526	658	724	789	888
kW	110	138	138	173	208	242	311	415	485	554	692	762	831	935
kW	115	143	143	179	215	251	323	430	503	574	718	790	862	970
kW	121	152	152	190	228	266	342	456	533	609	762	838	914	1028
kW	138	173	173	216	260	303	389	518	606	692	866	952	1039	1169
kW	182	228	228	285	343	400	514	684	800	914	1143	1257	1371	1543
kW	191	239	239	298	358	418	537	715	836	955	1195	1314	1434	1613
kW	221	277	216	345	415	433	546	727	692	911	-	-	-	-
A	145	170	170	180	200	280	360	400	550	600	800	875	960	1080
kW	55	64	64	68	76	106	137	152	209	228	304	333	365	411
kW	57	67	67	71	79	111	143	159	219	239	318	348	382	430
kW	59	70	70	74	83	116	150	166	228	249	332	363	399	448
kW	95	111	111	118	131	184	237	263	362	395	526	575	631	710
kW	100	117	117	124	138	193	249	277	381	415	554	606	665	748
kW	104	122	122	129	143	201	259	287	395	431	575	628	690	776
kW	110	129	129	137	152	213	274	304	419	457	609	666	731	823
kW	125	147	147	155	173	242	312	346	476	519	692	757	831	935
kW	165	194	194	205	228	320	412	457	628	685	914	1000	1097	1234
kW	173	202	202	215	239	334	430	478	657	717	956	1045	1147	1290
kW	166	187	216	277	346	388	499	554	692	866	-	-	-	-
mm ²	95	120	95	95	120	240	2x150	2x(30x6)	2x(40x5)	2x(50x5)	2x(60x5)	2x(60x6)	2x(60x6)	2x(60x8)
A	90	115	115	150	175	210	260	315	450	550	700	860	1000	1200
A	90	115	115	150	175	210	260	315	450	550	700	860	1000	1200
A	90	115	115	150	175	210	260	315	450	550	700	860	1000	1200
A	90	115	115	150	175	210	260	315	450	550	700	860	1000	1200
A	90	115	115	150	175	210	260	315	450	550	700	860	1000	1200
A	90	115	115	150	175	210	260	315	450	550	700	860	1000	1200
A	79	79	115	150	175	210	260	315	450	550	700	860	1000	1200
A	60	60	100	120	140	150	180	240	400	500	630	700	860	1000
A	45	45	45	60	70	85	100	125	200	250	-	-	-	-
kW	25	33	30	40	50	60	75	90	132	175	225	280	325	390
kW	27	35	35	45	55	65	80	100	140	185	235	290	335	400
kW	45	55	55	75	90	110	132	160	250	300	400	500	580	680
kW	49	63	59	80	95	115	140	180	257	315	415	515	600	710
kW	49	63	63	85	100	125	150	190	270	335	450	530	630	750
kW	55	55	75	90	100	132	160	210	300	375	500	600	720	850
kW	55	55	90	110	132	132	160	210	375	500	630	700	850	1000
kW	55	55	55	75	90	110	132	160	280	355	-	-	-	-

Contactors

Data according to IEC 947-4-1, EN 60947-4-1, VDE 0660

Main Contacts	Type	K(G)3-10	K(G)3-14	K(G)3-18	K(G)3-22	K(G)3-24	K(G)3-32	K(G)3-40	K3-50	K3-62	K3-74
Utilization category AC4											
Switching of squirrel cage motors, inching											
Rated operational current I_e	220V A	12	15	18	18	24	30	40	50	63	63
open and enclosed	230V A	11,5	14,5	18	18	24	30	40	50	62	62
	240V A	11	14	18	18	24	32	40	50	62	62
	380-400V A	10	14	18	18	24	32	40	50	62	62
	415V A	9	14	18	18	23	30	37	45	60	60
	440V A	9	14	18	18	23	30	37	45	55	55
	500V A	9	12	16	16	17,5	21	21	33	42	42
	660V A	7	9	9	9	17	20	20	31	40	40
	690V A	6,5	8,5	8,5	8,5	17	20	20	31	40	40
	1000V A	-	-	-	-	-	-	-	-	-	-
Rated operational power of three-phase motors 50-60Hz	220-230V kW	3	4	5	5	6	8,5	11	12,5	18,5	18,5
	240V kW	3	4	5	5	7	9	11,5	13,5	19	19
	380-400V kW	4	5,5	7,5	7,5	11	15	18,5	22	30	30
	415V kW	4,5	6	8,5	8,5	12	16	20	24	33	33
	440V kW	4,5	6	8,5	8,5	12	16	20	24	33	33
	500V kW	5,5	7,5	10	10	15	18,5	18,5	30	37	37
	660-690V kW	5,5	7,5	10	10	15	18,5	18,5	30	37	37
	1000V kW	-	-	-	-	-	-	-	-	-	-
Utilization category AC5a											
Switching of gas discharge lamps											
Rated operational current I_e per pole at 220/230V											
Fluorescent lamps, uncompensated and serial compensated											
	A	20	20	25	25	40	52	64	88	96	104
	A	7	9	9	9	18	22	22	30	40	40
	A	22,5	22,5	28	28	45	58	72	98	108	117
Metal halide lamps ¹⁾ , uncompensated											
	A	12	15	19	19	30	39	48	66	72	78
	A	7	9	9	9	18	22	22	30	40	40
Mercury-vapour lamps ²⁾ , uncompensated											
	A	22,5	25	28	28	45	58	72	99	108	117
	A	7	9	9	9	18	22	22	30	40	40
Mixed light lamps ³⁾											
	A	20	20	25	25	40	52	64	88	96	104
LED-Lamps											
consider the inrush current of the lamp ballast and $\cos\phi$ of the lamp.											
max. lamps per pole ($I_{rLED} \leq I_{rn}$)						= $\frac{\text{inrush current of contactor}}{\text{inrush current of lamp/EVG}}$					
max inrush current of contactor	A	282	282	282	282	564	705	705	987	1269	1268
Utilization category AC5b											
Switching of incandescent lamps ⁴⁾											
Rated operational current I_e per pole at 220/230V											
	A	12,5	12,5	12,5	12,5	25	31	31	43	56	56

1) Metal halide lamps and sodium-vapour lamps (high- and low-pressure lamps)

2) High-pressure lamps

3) Blended lamps, containing a mercury high-pressure unit and a tungsten helix in a fluorescent glass bulb (daylight lamps)

4) Current inrush approx. $16 \times I_e$

Contactors

Data according to IEC 947-4-1, EN 60947-4-1, VDE 0660

Type	K3-90	K3-115	K3-151	K3-176	K3-210	K3-260	K3-316	K3-450	K3-550	K3-700	K3-860	K3-1000	K3-1200
A	85	98	55	63	85	100	120	150	180	230	280	340	400
A	85	98	55	63	85	100	120	150	180	230	280	340	400
A	85	98	55	63	85	100	120	150	180	230	280	340	400
A	85	85	55	63	85	100	120	150	180	230	280	340	400
A	85	85	55	63	85	100	120	150	180	230	280	340	400
A	85	85	55	63	85	100	120	150	180	230	280	340	400
A	85	85	-	-	-	-	-	-	-	-	-	-	-
A	60	60	-	-	-	-	-	-	-	-	-	-	-
A	57,5	57,5	-	-	-	-	-	-	-	-	-	-	-
A	-	-	-	-	-	-	-	-	-	-	-	-	-
kW	25	30	15	18,5	25	30	37	45	51	68	80	110	132
kW	27	32	15,5	19	26	31	38	47	53	71	83	115	137
kW	45	45	25	30	45	55	63	75	90	120	150	185	220
kW	49	49	25	33	45	55	65	80	100	132	160	200	230
kW	49	49	30	34	48	55	67	85	100	132	160	200	230
kW	55	55	25	30	55	65	75	100	110	150	185	220	257
kW	55	55	25	30	55	65	75	100	110	150	185	220	257
kW	-	-	-	-	-	-	-	-	-	-	-	-	-
A	100	120	120	140	180	220	280	360	450	570	700	850	1000
A	55	70	85	100	130	160	200	300	360	460	550	660	800
A	112	144	120	140	180	220	280	360	450	570	700	850	1000
A	85	90	95	110	140	180	230	300	380	490	610	750	890
A	55	70	75	85	110	140	170	260	300	400	480	580	700
A	112	144	120	140	180	220	280	360	450	570	700	850	1000
A	55	70	75	85	110	140	170	260	300	400	480	580	700
A	100	120	100	120	160	200	250	320	400	500	600	700	800
	$\text{max. lamps per pole } (I_{nLED} \leq I_n) = \frac{\text{inrush current of contactor}}{\text{inrush current of lamp/EVG}}$												
A	1551	1692	2115	2820	2961	3666	4512	6345	7755	9870	12126	14100	16920
A	69	75	100	120	160	190	220	260	315	440	500	560	630

Contactors, Motor-Starters
 Circuit Breakers
 Manual Motor-Starters
 Switches
 AC-Main Switches
 DC-Switch Disconnectors
 Push Buttons
 Representatives, Suppliers

Contactors

Data according to IEC 947-4-1, EN 60947-4-1, VDE 0660

Main Contacts		Type	K(G)3-10	K(G)3-14	K(G)3-18	K(G)3-22	K(G)3-24	K(G)3-32	K(G)3-40	K3-50	K3-62	K3-74
Utilization category AC6a												
Transformer primary switching												
at inrush		n	30	30	30	30	30	30	30	30	30	30
Rated operational current I_e	400V	A	4,5	5,5	7,5	7,5	10,5	13,5	13,5	20	27	33
Rated operational power	220-230V	kVA	1,8	2,2	3	3	4,2	5,4	5,4	8	10,7	13
dependent on inrush n	240V	kVA	1,9	2,3	3,1	3,1	4,3	5,6	5,6	8,3	11,2	13,5
	380-400V	kVA	3,1	3,8	5,2	5,2	7,3	9,3	9,3	13,5	18,5	22,5
For different inrush-factors x	415-440V	kVA	3,4	4,2	5,7	5,7	8	10,2	10,2	15	20,5	25
use the following formula:	500V	kVA	3,9	4,8	6,5	6,5	9	11,5	11,5	17	23	28
$P_x = P_n * (n/x)$	660-690V	kVA	5,4	6,5	9	9	12,5	16	16	24	32	39
Utilization category AC6b												
Switching of three-phase capacitors												
Maximum inrush current (peak value)												
as multiple k of the												
capacitor rated current												
Rated operational current I_e	500V	k	35	25	20	20	25	25	25	25	25	20
		A	8	12	15,5	15,5	23	32	32	45	60	70
Rated operational current	220-230V	kVAr	3	4,5	6	6	8,5	12	12	17	24	28
($\sin\phi=1$)	240V	kVAr	3,5	5	6,5	6,5	9,5	13	13	18,5	25	29
	380-400V	kVAr	5	7,5	10	10	15	20	20	29	39	46
For different multiples x	415-440V	kVAr	5,5	8	11	11	16	22	22	32	43	50
use the following formula:	500V	kVAr	7	10	13	13	20	26	26	39	50	58
$P_x = P_k * (k/x)$	660-690V	kVAr	7	10	13	13	20	26	26	40	50	58
Switching of reactive capacitor banks												
Rated operational current I_e	690V	A	8	13	18	20	28	36	42	48	72	108 ¹⁾
Rated operational power	220-230V	kVAr	2,9	5	7	7,5	11	14	16	20	28	33
	240V	kVAr	3,1	5,4	7	8	11	14	17	20	28	36
	380-400V	kVAr	5	9	12,5	13	20	25	27,5	33,3	50	75 ¹⁾
	415-440V	kVAr	5,5	9,5	13	14	22	27	30	36	53	75 ¹⁾
	500V	kVAr	6	11	15	17	25	30	36	40	60	75
	660-690V	kVAr	8	15	20	22	33	41	48	55	82	100
	1000V	kVAr	-	-	-	-	-	-	-	-	-	-
Utilization category DC1												
Switching of resistive load												
Time constant $L/R \leq 1ms$												
Rated operational current I_e	1 pole	24V	A	20	25	32	32	50	65	80	110	130
		60V	A	20	25	32	32	50	65	80	110	130
		110V	A	6	6	6	6	10	10	12	12	12
		220V	A	0,8	0,8	0,8	0,8	1,4	1,4	1,4	1,4	1,4
	3 poles in series	24V	A	20	25	32	32	50	65	80	110	130
		60V	A	20	25	32	32	50	65	80	110	130
		110V	A	20	25	32	32	50	65	80	110	130
		220V	A	16	20	20	20	30	35	35	63	80
Utilization category DC3 and DC5												
Switching of shunt motors and series motors												
Time constant $L/R \leq 15ms$												
Rated operational current I_e	1 pole	24V	A	20	25	32	32	50	65	80	110	130
		60V	A	6	6	6	6	30	30	30	60	60
		110V	A	1,2	1,2	1,2	1,2	1,8	1,8	1,8	1,8	1,8
		220V	A	0,2	0,2	0,2	0,2	0,2	0,2	0,25	0,25	0,25
	3 poles in series	24V	A	20	25	32	32	50	65	80	110	130
		60V	A	20	25	32	32	40	40	40	80	80
		110V	A	20	20	20	20	40	40	40	80	80
		220V	A	2,5	2,5	2,5	2,5	4	4	4	5	5

1) Consider resistive load (I_{tr}). see page 62

Contactors



Data according to IEC 947-4-1, EN 60947-4-1, VDE 0660

Type	K3-90	K3-115	K3-151	K3-176	K3-210	K3-260	K3-316	K3-450	K3-550	K3-700	K3-860	K3-1000	K3-1200
n	30	30	30	30	30	30	30	30	30	30	30	30	30
A	38	50	65	80	90	120	142	203	248	315	390	450	540
kVA	15	20	25	30	34	45	54	77	95	120	148	170	200
kVA	15,5	20,5	27	33	37	50	59	80	100	130	160	185	220
kVA	26	34	45	55	60	80	95	140	170	210	270	310	370
kVA	29	38	46	57	63	85	100	145	175	220	280	320	380
kVA	33	43	55	69	75	100	120	170	210	270	330	380	460
kVA	45	60	56	69	100	135	160	200	250	320	350	500	600
k	20	20	20	20	25	20	20	20	20	20	20	20	20
A	87	100	120	155	195	225	255	300	370	440	520	680	760
kVAr	33	38	45	60	75	90	100	115	145	170	200	260	290
kVAr	36	42	52	62	78	94	104	120	150	175	205	270	300
kVAr	57	65	80	100	130	155	170	200	250	300	350	450	500
kVAr	60	70	95	110	135	165	175	210	260	310	360	465	520
kVAr	70	80	100	130	170	194	220	260	320	380	450	590	660
kVAr	70	80	100	130	170	194	220	260	320	380	450	590	660
A	115	144	115	140	200	225	250	330	420	550	600	680	760
kVAr	45	55	43	53	76	85	95	125	160	209	228	260	290
kVAr	45	55	45	55	80	90	100	130	170	220	240	280	310
kVAr	80	100	75	90	130	145	160	210	270	350	390	440	480
kVAr	100	120	80	100	140	160	170	230	290	380	420	470	530
kVAr	105	125	95	120	170	190	210	280	350	450	500	570	640
kVAr	120	148	125	150	200	230	260	350	450	600	650	700	800
kVAr	160	200	155	200	300	340	400	500	650	-	-	-	-
A	160	200	-	-	-	-	-	-	-	-	-	-	-
A	160	200	-	-	-	-	-	-	-	-	-	-	-
A	20	25	-	-	-	-	-	-	-	-	-	-	-
A	2	2,5	-	-	-	-	-	-	-	-	-	-	-
A	160	200	200	250	350	400	450	600	760	1000	1100	1200	1350
A	160	200	200	250	350	400	450	600	760	1000	1100	1200	1350
A	160	200	150	170	250	280	315	400	480	560	630	800	900
A	100	160	80	100	150	180	200	250	315	400	450	500	600
A	160	200	-	-	-	-	-	-	-	-	-	-	-
A	85	110	-	-	-	-	-	-	-	-	-	-	-
A	2	2,5	-	-	-	-	-	-	-	-	-	-	-
A	0,5	0,5	-	-	-	-	-	-	-	-	-	-	-
A	160	200	-	-	-	-	-	-	-	-	-	-	-
A	100	110	-	-	-	-	-	-	-	-	-	-	-
A	100	110	-	-	-	-	-	-	-	-	-	-	-
A	7	8	-	-	-	-	-	-	-	-	-	-	-

Contactors, Motor-Starters
Circuit Breakers
Manual Motor-Starters
Switches
AC-Main Switches
DC-Switch Disconnectors
Push Buttons
Representatives, Suppliers

Contactors







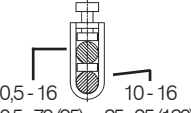

Data according to IEC 947-4-1, EN 60947-4-1, VDE 0660

Main Contacts	Type	K(G)3-10K(G)3-14K(G)3-18K(G)3-22K(G)3-24K(G)3-32K(G)3-40K3-50	K3-62	K3-74							
Maximum ambient temperature											
Operation	open °C	-40 to +60 (+90) ¹⁾									
	enclosed °C	-40 to +40									
with thermal overload relay	open °C	-25 to +60									
	enclosed °C	-25 to +40									
Storage	°C	-50 to +90									
Short circuit protection											
for contactors without thermal overload relay											
Coordination-type "1" according to IEC 947-4-1											
Contact welding without hazard of persons											
max. fuse size	gL (gG) A	63	63	63	63	100	100	100	160	160	160
Coordination-type "2" according to IEC 947-4-1											
Light contact welding accepted											
max. fuse size	gL (gG) A	25	35	35	35	50	50	50	100	125	125
Contact welding not accepted											
max. fuse size	gL (gG) A	16	16	16	16	25	35	35	50	63	63
For contactors with thermal overload relay the device with the smaller admissible backup fuse (contactor or thermal overload relay) determines the fuse size.											
Cable cross-sections											
for contactors without thermal overload relay											
1 cable per clamp											
main connector	solid or stranded mm ²										
	flexible mm ²	0,75 - 6		1,5 - 25		4 - 50					
	flexible with multicore cable end mm ²	1 - 4		2,5 - 16		10 - 35					
		0,75 - 4		1,5 - 16		6 - 35					
2 cables per clamp											
	solid or stranded mm ²	6+(1-6) / 4+(0,75-4)		16+(2,5-16) / 10+(4-16)		50+4 / 35+6 / 25+(6-16)					
	flexible mm ²	2,5+(0,75-2,5) / 1,5+(0,75-1,5)		6+(4-16) / 4+(2,5-16)		16+(6-16) / 10+(6-16)					
		6+(1,5-4) / 4+(1-4)		16+(2,5-6) / 10+(4-10)		50+(4-10) / 35+(4-16)					
		2,5+(0,75-2,5) / 1,5+(0,75-1,5)		6+(4-16) / 4+(2,5-16)		25+(4-25) / 16+(4-16)					
1 cable per clamp											
main connector	solid AWG	18 - 10		16 - 10		12 - 10					
	flexible AWG	18 - 10		14 - 4		10 - 0					
2 cables per clamp											
	solid AWG	10+(16-10) / 12+(18-12)		10+(16-10) / 12+(18-12)		10+(12-10) / 12+12					
	flexible AWG	14+(18-14) / 16+(18-16)		14+(18-14) / 16+(18-16)		4+(18-12) / 6+(18-8)		1+(12-10) / 2+(8-12)			
		10+(14-10) / 12+(18-12)		8+(18-8) / 10+(18-12)		3+(12-8) / 4+(10-6)					
		14+(18-14) / 16+(18-16)									
Frequency of operations z											
Contactors without thermal overload relay											
	without load 1/h	10000		7000		7000					
	AC3, I _e 1/h	600		600		400					
	AC4, I _e 1/h	120		120		120					
	DC3, I _e 1/h	600		600		400					
Mechanical life											
AC operated	S x 10 ⁶	10		10		10					
DC operated	S x 10 ⁶	10		10		10					
DC-solenoid operated (KG3)	S x 10 ⁶	50		50		-					
Short time current											
	10s-current A	96	120	144	176	184	240	296	450	504	592
	120s-current A	42	52	58	66	80	97	110	195	203	222
Power loss per pole											
contact resistance	at I _e /AC3 400V mOhm	0,21	0,35	0,5	0,75	0,7	1,3	2	2,2	3,9	5,5
		2,1	1,8	1,5	1,5	1,2	1,2	1,2	1	1	1
Resistance to shock acc. to IEC 60068-2-27											
Shock time 20ms sine-wave	NO g	10	10	10	10	8	8	8	8	8	8
	NC g	6	6	6	6	-	-	-	-	-	-

1) With reduced control voltage range 0,9 up to 1,0 x U_s and with reduced rated current I_e/AC1 according to I_e/AC3

Contactors

Data according to IEC 947-4-1, EN 60947-4-1, VDE 0660

Type	K3-90	K3-115	K3-116	K3-151	K3-176	K3-210	K3-260	K3-316	K3-450	K3-550	K3-700	K3-860	K3-1000	K3-1200		
°C	-40 bis +60 (+90) ¹⁾															
°C	-40 to +40															
°C	-25 to +60															
°C	-25 to +40															
°C	-50 to +90															
A	250	250	200	250	315	400	450	500	630	630	800	1000	1000	1250		
A	160	200	160	200	250	315	400	400	500	560	-	-	-	-		
A	100	125	125	160	200	250	315	-	-	-	-	-	-	-		
mm ²																
mm ²	0,5 - 16	10 - 16	busbar 18 x 4 screw M8		busbar 25 x 6 screw M10		busbar 30 x 5 screw M12		busbar 40 x 6 screw M12		busbar 50 x 8 screw M12		busbar 50 x 8 screw M14		busbar 50 x 10 screw 2 x M12	
mm ²	0,5 - 70 (95)	25 - 95 (120)														
mm ²	0,5 - 70	10 - 95														
mm ²	0,5 - 95 + 10 - 120															
mm ²	0,5 - 70 + 25 - 95															
AWG	18 - 10	-														
AWG	18 - 3/0	8 - 4/0														
AWG	-															
AWG	18 - 3/0 + 8 - 4/0															
1/h	3000		1200		1200		1200		1200		300		300			
1/h	300		240		150		50		25		20		-			
1/h	120		-		-		-		-		-		-			
1/h	300		-		-		-		-		-		-			
S x 10 ⁶	5		10		5		5		5		5 ³⁾		5 ³⁾			
S x 10 ⁶	5		10		5		5		5		5 ³⁾		5 ³⁾			
S x 10 ⁶	-		-		-		-		-		-		-			
A	680	880	920	1200	1400	1800	2200	2600	3600	4400	5600	6900	8000	9600		
A	275	330	410	500	575	800	900	1000	1400	1750	2200	2600	3000	3600		
W	4,8	7,9	7,9	9	11	8	11	14,9	26,3	33,3	49	59,2	60	72		
mOhm	0,6	0,5	0,5	0,4	0,35	0,18	0,16	0,15	-	-	-	-	-	-		
g	7	7	-	-	-	-	-	-	-	-	-	-	-	-		
g	5	5	-	-	-	-	-	-	-	-	-	-	-	-		

1) With reduced control voltage range 0,9 up to 1,0 x U_s and with reduced rated current I_b/AC1 according to I_b/AC3

2) With reduced control voltage range 1,0 x U_s and with reduced rated current I_b/AC1 according to I_b/AC3

3) After each 1x10⁶ operations magnetic core and built-in auxiliary contact block must be changed

Contactors

Data according to IEC 947-4-1, EN 60947-4-1, VDE 0660

Auxiliary Contacts			Type	K(G)3-10	K(G)3-14	K(G)3-18	K(G)3-22	K(G)3-24	K(G)3-32	K(G)3-40	K3-50	K3-62	K3-74
Rated insulation voltage U_i ¹⁾			V~	690				-		-			
Thermal rated current I_{th} to 690V													
Ambient temperature			40°C A	10				(16) ⁵⁾		-			
			60°C A	6				(12) ⁵⁾		-			
Utilization category AC15													
Rated operational current I_e			220-240V A	3				(12) ⁵⁾		-			
			380-415V A	2				(4) ⁵⁾		-			
			440V A	1,6				(4) ⁵⁾		-			
			500V A	1,2				(3) ⁵⁾		-			
			660-690V A	0,6				(1) ⁵⁾		-			
Utilization category DC13													
Rated operational current I_e			60V A	3,5				(8) ⁵⁾		-			
			110V A	0,5				(1) ⁵⁾		-			
			220V A	0,1						-			
Short circuit protection short-circuit current 1kA, contact welding not accepted max. fuse size			gL (gG) A	20 (25) ⁵⁾				-		-			
Control Circuit Power consumption of coils													
AC operated			inrush VA	33-45				90-115		140-165			
			sealed VA	7-10				9-13		13-18			
			W	2,6-3				2,7-4		5,4-7			
DC operated			inrush W	75				140		200			
double winding coil			sealed W	2				2		6			
DC solenoid operated (KG3)			inrush W	3				4		-			
			sealed W	3				4		-			
Operation range of coils in multiples of control voltage U_c													
			AC operated	0,85-1,1				0,85-1,1		0,85-1,1			
			DC operated	0,8-1,1				0,8-1,1		0,8-1,1			
Switching time at control voltage $U_c \pm 10\%$ ^{2) 3)}													
AC operated			make time ms	8-16				10-25		12-28			
			release time ms	5-13				8-15		8-15			
			arc duration ms	10-15				10-15		10-15			
DC operated			make time ms	8-12				10-20		12-23			
double winding coil			release time ms	8-13				10-15		10-18			
			arc duration ms	10-15				10-15		10-15			
DC solenoid operated (KG3)			make time ms	65 - 85				65 - 85		-			
			release time ms	20 - 30 ⁴⁾				20 - 30 ⁴⁾		-			
			arc duration ms	10-15				10-15		-			
Cable cross-section													
Auxiliary connector			solid mm ²	0,75-6				-		-			
			flexible mm ²	1-4				-		-			
			flexible with multicore cable end mm ²	0,75-4				-		-			
Magnet coil			solid mm ²	0,75-2,5				0,75-2,5		0,75-2,5			
			flexible mm ²	0,5-2,5				0,5-2,5		0,5-2,5			
			flexible with multicore cable end mm ²	0,5-1,5				0,5-1,5		0,5-1,5			
Clamps per pole				2				2		2			
Auxiliary connector			solid AWG	18 - 10				-		-			
			flexible AWG	18 - 10				-		-			
Magnet coil			solid AWG	14 - 12				14 - 12		14 - 12			
			flexible AWG	18 - 12				18 - 12		18 - 12			
Clamps per pole				2				2		2			

1) Suitable for: earthed-neutral systems, overvoltage category I to IV, pollution degree 3 (standard-industry): $U_{imp} = 8kV$. Data for other conditions on request

2) Total breaking time = release time + arc duration

3) Values for delay of the release time of the make contact and the make time of the break contact will be increased, if magnet coils are protected against voltage peaks (varistor, RC-unit, diode-unit)

4) with built-in coil suppressor 5) for contactors KG3-...A.. only

Contactors

Data according to IEC 947-4-1, EN 60947-4-1, VDE 0660

Type	K3-90	K3-115	K3-116	K3-151	K3-176	K3-210	K3-260	K3-316	K3-450	K3-550	K3-700	K3-860	K3-1000	K3-1200
V~	-	-	-	-	-	-	-	-	690	-	690	-	690	-
A	-	-	-	-	-	-	-	-	10	-	10	-	10	-
A	-	-	-	-	-	-	-	-	-	-	-	-	-	-
-	-	-	-	-	-	-	-	-	-	-	-	-	-	-
A	-	-	-	-	-	-	-	-	3	-	3	-	3	-
A	-	-	-	-	-	-	-	-	2	-	2	-	2	-
A	-	-	-	-	-	-	-	-	1,5	-	1,5	-	1,5	-
A	-	-	-	-	-	-	-	-	1,5	-	1,5	-	1,5	-
A	-	-	-	-	-	-	-	-	1	-	1	-	1	-
A	-	-	-	-	-	-	-	-	-	-	-	-	-	-
A	-	-	-	-	-	-	-	-	1	-	1	-	1	-
A	-	-	-	-	-	-	-	-	0,5	-	0,5	-	0,5	-
A	-	-	-	-	-	-	-	-	-	-	-	-	-	-
A	-	-	-	-	-	-	-	-	10	-	10	-	10	-
VA	165-220	-	-	350	-	-	360	-	800-950	-	1350-1600	-	2400	-
VA	2,5-5	-	-	5	-	-	5	-	9-11	-	21-25	-	70	-
W	2,5-5	-	-	5	-	-	5	-	9-11	-	21-25	-	70	-
W	250	-	-	350	-	-	360	-	700-850	-	1300-1550	-	2100	-
W	5	-	-	5	-	-	5	-	8-10	-	18-22	-	60	-
W	-	-	-	-	-	-	-	-	-	-	-	-	-	-
W	-	-	-	-	-	-	-	-	-	-	-	-	-	-
ms	0,85-1,1 0,8-1,1	-	-	0,85-1,1 0,85-1,1	-	-	0,85-1,1 0,85-1,1	-	0,85-1,1 0,85-1,1	-	0,85-1,1 0,85-1,1	-	0,85-1,1 0,85-1,1	-
ms	20-35	-	-	30-60	-	-	40-60	-	50-100	-	50-100	-	50-100	-
ms	35-50	-	-	30-80	-	-	15-45	-	150-200 / 500-1000 ¹⁾	-	25-50	-	25-50	-
ms	10-15	-	-	-	-	-	-	-	-	-	-	-	-	-
ms	20-35	-	-	30-60	-	-	40-60	-	-	-	-	-	-	-
ms	35-50	-	-	30-80	-	-	15-45	-	-	-	-	-	-	-
ms	10-15	-	-	-	-	-	-	-	-	-	-	-	-	-
ms	-	-	-	-	-	-	-	-	-	-	-	-	-	-
ms	-	-	-	-	-	-	-	-	-	-	-	-	-	-
ms	-	-	-	-	-	-	-	-	-	-	-	-	-	-
mm ²	-	-	-	-	-	-	-	-	0,75-2,5	-	0,75-2,5	-	0,75-2,5	-
mm ²	-	-	-	-	-	-	-	-	0,75-2,5	-	0,75-2,5	-	0,75-2,5	-
mm ²	-	-	-	-	-	-	-	-	-	-	-	-	-	-
mm ²	0,75-2,5	-	-	1-2,5	-	-	1-2,5	-	1-2,5	-	1-2,5	-	1-2,5	-
mm ²	0,5-2,5	-	-	1-2,5	-	-	1-2,5	-	1-2,5	-	1-2,5	-	1-2,5	-
mm ²	0,5-1,5	-	-	-	-	-	-	-	-	-	-	-	-	-
mm ²	2	-	-	2	-	-	2	-	2	-	2	-	2	-
AWG	-	-	-	-	-	-	-	-	16 - 12	-	16 - 12	-	16 - 12	-
AWG	-	-	-	-	-	-	-	-	16 - 12	-	16 - 12	-	16 - 12	-
AWG	14 - 12	-	-	16 - 12	-	-	16 - 12	-	16 - 12	-	16 - 12	-	16 - 12	-
AWG	18 - 12	-	-	16 - 12	-	-	16 - 12	-	16 - 12	-	16 - 12	-	16 - 12	-
	2	-	-	2	-	-	2	-	2	-	2	-	2	-

1) Normal or delayed drop is adjustable

Contactors, Motor-Starters
 Circuit Breakers
 Manual Motor-Starters
 Switches
 AC-Main Switches
 DC-Switch Disconnectors
 Push Buttons
 Representatives, Suppliers

Contactors

Data according to IEC 947-4-1, EN 60947-4-1, VDE 0660

Main Contacts	Type	K2-09	K2-12	K2-16	K2-23	K2-30	K2-37	K2-45	K2-60	K85	K110
Rated insulation voltage U_i ¹⁾	V~	690	690	690	690	690	690	690	690	750	750
Making capacity I_{eff} at $U_e = 690V\sim$	A	200	200	200	400	500	500	700	900	1100	1200
Breaking capacity I_{eff} 400V~	A	180	180	200	380	400	400	600	800	950	1100
K2-09 to K2-16 $\cos\phi = 0,65$ 500V AC	A	150	150	180	300	370	370	500	700	850	1100
K2-23 to K3-1200 $\cos\phi = 0,35$ 690V AC	A	100	100	150	260	340	340	400	500	600	600
	A	-	-	-	-	-	-	-	-	-	-
Utilization category AC1											
Switching of resistive load											
Rated operational current $I_e (=I_{th})$ at 40°C, open	A	25	25	25	45	50	50	80	100	150	170
Rated operational power of three-phase resistive loads 50-60Hz, $\cos\phi = 1$	220V kW	9,5	9,5	9,5	17	19	19	30	38	57	64
	230V kW	10	10	10	18	20	20	31,5	40	59	67
	240V kW	10,5	10,5	10,5	18,5	20,5	20,5	33	41	62	70
	380V kW	16,5	16,5	16,5	29,5	33	33	52	65	98	111
	400V kW	17,5	17,5	17,5	31	34,5	34,5	55	69	103	117
	415V kW	18	18	18	32	36	36	57	71	107	122
	440V kW	19	19	19	34	38	38	61	76	114	129
	500V kW	21,5	21,5	21,5	39	43	43	69	86	130	147
	660V kW	28,5	28,5	28,5	51	57	57	91	114	171	194
	690V kW	29,5	29,5	29,5	53,5	60	60	95	119	179	203
Rated operational current $I_e (=I_{th})$ at 60°C, enclosed	A	20	25	25	35	40	40	63	80	100	125
Rated operational power of three-phase resistive loads 50-60Hz, $\cos\phi = 1$	220V kW	7,5	9,5	9,5	13	15	15	24	30	38	47
	230V kW	8	10	10	13,5	16	16	25	31,5	40	49
	240V kW	8	10,5	10,5	14,5	16,5	16,5	26	33	41	52
	380V kW	13	16,5	16,5	23	26	26	41	52	65	82
	400V kW	13,5	17,5	17,5	24	27,5	27,5	43	55	69	86
	415V kW	14	18	18	25	28,5	28,5	45	57	71	89
	440V kW	15	19	19	26,5	30	30	48	61	71	95
	500V kW	17	21,5	21,5	30	34	34	54	69	86	116
	660V kW	22,5	28,5	28,5	40	45	45	72	91	114	142
	690V kW	23,5	29,5	29,5	42	48	48	75	95	119	149
Minimum cross-section of conductor at load with $I_e (=I_{th})$	mm ²	4	4	4	10	10	10	25	35	50	70
Utilization category AC2 and AC3											
Switching of three-phase motors											
Rated operational current I_e open and enclosed	220V A	12	15	18	23	30	37	45	63	85	110
	230V A	11,5	14,5	17,5	23	30	37	45	61	85	110
	240V A	11	14	17	23	30	37	45	60	85	110
	380-400V A	10	12	16	23	30	37	45	60	85	110
	415-440V A	9	12	16	23	30	37	45	60	85	110
	500V A	9	12	16	23	30	30	45	55	85	110
	660V A	7	9	9	17,5	21	21	33	42	60	60
	690V A	6,5	8,5	8,5	17	20	20	31	40	58	58
Rated operational power of three-phase motors 50-60Hz	220-230V kW	3	4	5	6	8,5	11	12,5	18,5	25	33
	240V kW	3	4	5	7	9	11,5	13,5	19	27	35
	380-400V kW	4	5,5	7,5	11	15	18,5	22	30	45	55
	415V kW	4,5	6	8,5	12	16	20	24	33	49	63
	440V kW	4,5	6	8,5	12	16	20	24	33	49	63
	500V kW	5,5	7,5	10	15	18,5	18,5	30	37	55	55
	660-690V kW	5,5	7,5	7,5	15	18,5	18,5	30	37	55	55

1) Suitable at 690V for: earthed-neutral systems, overvoltage category I to IV, pollution degree 3 (standard-industry): $U_{imp} = 8kV$.
Data for other conditions on request.

Contactors

Data according to IEC 947-4-1, EN 60947-4-1, VDE 0660

Main Contacts	Type	K2-09	K2-12	K2-16	K2-23	K2-30	K2-37	K2-45	K2-60	K85	K110
Utilization category AC4											
Switching of squirrel cage motors, inching											
Rated operational current I_e	220V A	12	15	16	23	30	37	45	63	85	98
open and enclosed	230V A	11,5	14,5	16	23	30	37	45	61	85	98
	240V A	11	14	16	23	30	37	45	60	85	98
	380-400V A	10	12	16	23	30	37	45	60	85	85
	415V A	9	12	16	21	28	37	45	60	85	85
	440V A	9	12	16	21	28	37	45	60	85	85
	500V A	9	12	16	17	23	23	45	55	85	85
	660V A	7	9	9	13	17	17	33	42	60	60
	690V A	6,5	8,5	8,5	12,5	16,5	16,5	31	40	57,5	57,5
Rated operational power of three-phase motors	220-230V kW	3	4	5	6	8,5	11	12,5	18,5	25	30
	240V kW	3	4	5	7	9	11,5	13,5	19	27	32
50-60Hz	380-400V kW	4	5,5	7,5	11	15	18,5	22	30	45	45
	415-440V kW	4,5	6	8,5	11	15	20	24	33	49	49
	500V kW	5,5	7,5	10	11	15	15	30	37	55	55
	660-690V kW	5,5	7,5	7,5	11	15	15	30	37	55	55
Utilization category AC5a											
Switching of gas discharge lamps											
Rated operational current I_e per pole at 220/230V											
Fluorescent lamps, uncompensated	A	20	20	20	35	40	40	65	85	100	120
Fluorescent lamps, compensated	A	7	9	9	18	22	22	30	40	55	70
Fluorescent lamps, dual-connection	A	22,5	22,5	22,5	41	45	45	72	90	112	144
Metal-halide lamps ¹⁾ , uncompensated	A	12	15	15	28	30	30	50	62	85	90
Metal-halide lamps ¹⁾ , compensated	A	7	9	9	18	22	22	30	40	55	70
Mercury-vapour lamps ²⁾ , uncompensated	A	22,5	25	25	41	45	45	72	90	112	144
Mercury-vapour lamps ²⁾ , compensated	A	7	9	9	18	22	22	30	40	55	70
Mixed light lamps ³⁾	A	20	20	20	35	40	40	65	85	100	120
Utilization category AC5b											
Switching of incandescent lamps⁴⁾											
Rated operational current I_e per pole at 220/230V	A	12,5	12,5	12,5	25	31	31	43	56	69	75
Utilization category AC6a											
Transformer primary switching											
at inrush	n	30	30	30	30	30	30	30	30	30	30
Rated operational current I_e	400V A	4,5	5,5	7,5	10,5	13,5	13,5	20	27	38	50
Rated operational power dependent on inrush n	220-230V kVA	1,8	2,2	3	4,2	5,4	5,4	8	10,7	15	20
	240V kVA	1,9	2,3	3,1	4,3	5,6	5,6	8,3	11,2	15,5	20,5
	380-400V kVA	3,1	3,8	5,2	7,3	9,3	9,3	13,5	18,5	26	34
For different inrush-factors x use the following formula: $P_x = P_n \cdot (n/x)$	415-440V kVA	3,4	4,2	5,7	8	10,2	10,2	15	20,5	29	38
	500V kVA	3,9	4,8	6,5	9	11,5	11,5	17	23	33	43
	660-690V kVA	5,4	6,5	9	12,5	16	16	24	32	45	60
Utilization category DC1											
Switching of resistive load											
Time constant $L/R \leq 1ms$	1 pole 24V A	20	25	25	45	50	50	80	100	150	170
Rated operational current I_e	60V A	20	25	25	45	50	50	80	100	150	170
	110V A	6	6	6	10	10	10	12	12	20	25
	220V A	0,8	0,8	0,8	1,4	1,4	1,4	1,4	1,4	2	2,5
	2 poles in series 24V A				45	50	50				
	60V A				45	50	50				
	110V A				45	50	50				
	220V A				10	10	10				
	3 poles in series 24V A	20	25	25	45	50	50	80	100	150	170
	60V A	20	25	25	45	50	50	80	100	150	170
	110V A	20	25	25	45	50	50	80	100	150	170
	220V A	16	20	20	30	35	35	63	80	100	160

1) Metal halide lamps and sodium-vapour lamps (high- and low-pressure lamps)

2) High-pressure lamps

3) Blended lamps, containing a mercury high-pressure unit and a tungsten helix in a fluorescent glass bulb (daylight lamps)

4) Current inrush approx. $16 \times I_e$

5) With central compensation pay attention to the current inrush (capacitor switching contactors)

Contactors

Data according to IEC 947-4-1, EN 60947-4-1, VDE 0660

Main Contacts	Type	K2-09	K2-12	K2-16	K2-23	K2-30	K2-37	K2-45	K2-60	K85	K110	
Utilization category DC3 and DC5												
Switching of shunt motors and series motors												
Time constant L/R ≤15ms	1 pole 24V	A	20	25	25	45	50	50	80	100	150	170
Rated operational current I _e	60V	A	6	6	6	30	30	30	60	60	85	110
	110V	A	1,2	1,2	1,2	1,8	1,8	1,8	1,8	1,8	2	2,5
	220V	A	0,2	0,2	0,2	0,2	0,2	0,2	0,25	0,25	0,5	0,5
	2 poles in series 24V	A				45	50	50				
	60V	A				45	50	50				
	110V	A				30	30	30				
	220V	A				1,8	1,8	1,8				
3 poles in series	24V	A	20	25	25	45	50	50	80	100	150	170
	60V	A	20	25	25	40	40	40	80	80	100	110
	110V	A	20	20	20	40	40	40	80	80	100	110
	220V	A	2,5	2,5	2,5	4	4	4	5	5	7	8
Maximum ambient temperature												
Operation	open	°C										
	enclosed	°C										
with thermal overload relay	open	°C										
	enclosed	°C										
Storage		°C										
Short circuit protection												
for contactors without thermal overload relay												
Coordination-type "1" according to IEC 947-4-1												
Contact welding without hazard of persons												
max. fuse size	gL (gG)	A	63	63	63	80	80	80	160	160	250	250
Coordination-type "2" according to IEC 947-4-1												
Light contact welding accepted												
max. fuse size	gL (gG)	A	25	35	35	50	50	50	100	125	160	200
Contact welding not accepted												
max. fuse size	gL (gG)	A	16	16	16	25	35	35	50	63	100	125
For contactors with thermal overload relay the device with the smaller admissible backup fuse (contactor or thermal overload relay) determines the fuse size.												
Cable cross-sections												
for contactors without thermal overload relay												
main connector	solid or stranded	mm ²	0,75 - 4			1,5-10 + 1,5-6			4 - 35 ²⁾		10 - 70 ²⁾	
	flexible	mm ²	0,75 - 2,5			1,5-6 + 1,5-4			6 - 25 ²⁾		10 - 70 ²⁾	
Cables per clamp	flexible with multicore cable end	mm ²	0,5 - 2,5			1,5-6 + 1,5-4			4 - 25		10 - 35	
			2			1+1			1		1	
main connector	solid	AWG	14 - 10			14 - 10 + 14 - 10			10		10	
	flexible	AWG	18 - 10			14 - 8 + 14 - 10			10 - 2		6 - 0	
Cables per clamp			2			1+1			1		1	
Frequency of operations z												
Contactors without thermal overload relay												
	without load	1/h	10000			7000			7000		3000	
	AC3, I _e	1/h	600			600			400		300	
	AC4, I _e	1/h	120			120			120		120	
	DC3, I _e	1/h	600			600			400		300	
Mechanical life												
AC operated		S x 10 ⁶	10			10			10		5	
DC operated with economy resistor		S x 10 ⁶	10			10			10		5	
Short time current												
	10s-current	A	96	120	144	184	240	296	360	504	680	880
Power loss per pole												
	at I _e /AC3 400V	W	0,21	0,26	0,4	0,63	1,1	1,7	1,8	3,6	4,3	6,0
Resistance to shock acc. to IEC 68-2-27												
Shock time 20ms sine-wave	NO	g	10	10	10	8	8	8	8	8	7	7
	NC	g	6	6	6	5	5	5	-	-	5	5

1) With reduced control voltage range 0,9 up to 1,0 x U_s and with reduced rated current I_e /AC1 according to I_e /AC3

2) Maximum cable cross-section with prepared conductor

Contactors

Data according to IEC 947-4-1, EN 60947-4-1, VDE 0660

Auxiliary Contacts	Type	K2-09	K2-12	K2-16	K2-23	K2-30	K2-37	K2-45	K2-60	K85	K110
Rated insulation voltage U_i ¹⁾	V AC		690			690			-		690
Thermal rated current I_{th} to 690V											
Ambient temperature	40°C A		16			16			-		16
	60°C A		12			12			-		12
Utilization category AC15											
Rated operational current I_e	220-240V A		12			12			-		12
	380-415V A		4			4			-		6
	440V A		4			4			-		6
	500V A		3			3			-		4
	660-690V A		1			1			-		2
Utilization category DC13											
Rated operational current I_e	60V A		8			8			-		8
	110V A		1			1			-		1
	220V A		0,1			0,1			-		0,1
Short circuit protection short-circuit current 1kA, contact welding not accepted max. fuse size gL (gG) A For contactors with thermal overload relay the device with the smaller admissible control fuse (contactor or thermal overload relay) determines the fuse.			25			-			-		25
Control Circuit											
Power consumption of coils											
AC operated	inrush VA		33-45			90-115		140-165		280-350	350-420
	sealed VA		7-10			9-13		13-18		16-23	23-29
	W		2,6-3			2,7-4		5,4-7		4-6	6-7,3
DC operated	inrush W		75			140		200		170	320
with economic circuit	sealed W		2			2		6		2	4
Operation range of coils in multiples of control voltage U_s											
	AC operated		0,85-1,1			0,85-1,1		0,85-1,1		0,85-1,1	0,85-1,1
	DC operated		0,8-1,1			0,8-1,1		0,8-1,1		0,8-1,1	0,8-1,1
Switching time at control voltage $U_s \pm 10\%$ ^{2) 3)}											
AC operated	make time ms		8-16			10-25		12-28		13-30	13-30
	release time ms		5-13			8-15		8-15		8-15	8-15
	arc duration ms		10-15			10-15		10-15		10-15	10-15
DC operated	make time ms		8-12			10-20		12-23		20-30	20-30
with AC magnet system	release time ms		8-13			10-15		10-18		10-18	10-18
	arc duration ms		10-15			10-15		10-15		10-15	10-15
Cable cross-section											
Auxiliary connector	solid mm ²		0,75-4			-		-		0,75-2,5	0,75-2,5
	flexible mm ²		0,75-2,5			-		-		0,75-2,5	0,75-2,5
	flexible with multicore cable end mm ²		0,5-2,5			-		-		0,5-1,5	0,5-1,5
Magnet coil	solid mm ²		0,75-2,5			0,75-2,5		0,75-2,5		0,75-2,5	0,75-2,5
	flexible mm ²		0,5-2,5			0,5-2,5		0,5-2,5		0,5-2,5	0,5-2,5
	flexible with multicore cable end mm ²		0,5-1,5			0,5-1,5		0,5-1,5		0,5-1,5	0,5-1,5
Clamps per pole			2			2		2		2	2

1) Suitable for: earthed-neutral systems, overvoltage category I to IV, pollution degree 3 (standard-industry): $U_{imp} = 8kV$. Data for other conditions on request

2) Total breaking time = release time + arc duration

3) Values for delay of the release time of the make contact and the make time of the break contact will be increased, if magnet coils are protected against voltage peaks (varistor, RC-unit, diode-unit)

Contactors for North America

Data according to UL508

Main Contacts (cULus)		Type	K(G)3-10	K(G)3-14	K(G)3-18	K(G)3-22	K(G)3-24	K(G)3-32	K(G)3-40	K3-50	K3-62	K3-74
Rated operational current "General Use"		A	25	25	30	30	50	65	80	110	120	130
Motor DOL 3-phase at 60Hz												
Rated operational power	110-120V	hp	1½	2	2	3	5	5	7½	10	10	10
	200V	hp	3	3	5	5	7½	10	10	15	20	25
	220-240V	hp	3	3	7½	7½	10	10	15	20	25	30
	277V	hp	3	5	7½	7½	7½	10	15	20	25	30
	380-415V	hp	5	5	10	10	10	15	20	25	30	40
	440-480V	hp	5	7½	10	15	15	20	25	30	40	50
550-600V	hp	7½	10	15	20	20	25	30	40	50	50	
Motor DOL 1-phase at 60Hz												
Rated operational power of AC motors at 60Hz (1ph)	110-120V	hp	½	¾	1	1½	1½	2	3	3	5	7½
	200V	hp	1	1,5	2	3	3	5	7½	7½	10	15
	220-240V	hp	1½	2	3	3	5	5	7½	10	15	15
	277V	hp	2	3	3	5	5	7½	10	10	15	15
	380-415V	hp	3	3	5	5	5	7½	10	15	20	20
	440-480V	hp	3	5	5	7½	7½	10	15	20	25	25
550-600V	hp	3	5	7½	10	10	15	20	25	30	30	
Motor DOL 3-phase according to ASME A17.5												
Rated operational current	600V	A	-	-	-	-	15	22	-	27	37	-
Rated operational power of 3-phase motors for elevators (500.000 operations)	110-120V	hp	-	-	-	-	2	3	-	3	5	-
	200V	hp	-	-	-	-	3	5	-	7½	10	-
	220-240V	hp	-	-	-	-	5	7½	-	7½	10	-
	440-480V	hp	-	-	-	-	10	15	-	20	25	-
550-600V	hp	-	-	-	-	10	20	-	25	30	-	
Rated current 2 series contacts	600V	A	-	-	-	-	22	27	-	44	52	66
Fuse Class RK5 / Short-circuit current		A/kA	50/5	50/5	70/5	90/5	90/5	125/5	175/5	200/5	250/5	300/5
Fuse Class T / Short-circuit current		A/kA	45/100	50/100	70/100	90/100	110/100	150/100	150/100	175/100	175/100	175/100
Rated voltage		V	600	600	600	600	600	600	600	600	600	600
Auxiliary Contacts (cULus)			A600	A600	A600	A600	-	-	-	-	-	-

Main Contacts (cULus)		Type	K2-09	K2-12	K2-16	K2-23	K2-30	K2-45	K2-60	K85	K110	
Rated operational current "General Use"		A	25	25	25	40	40	72	90	125	150	
Motor DOL 3-phase at 60Hz												
Rated operational power	110-120V	hp	1½	2	2	3	5	-	-	15	-	
	200V	hp	2	3	3	5	7½	10	15	-	30	
	220-240V	hp	3	3	5	7½	10	15	20	35	40	
	440-480V	hp	5	7½	10	15	20	30	40	65	75	
550-600V	hp	7½	10	15	20	25	40	50	85	100		
Motor DOL 1-phase at 60Hz												
Rated operational power	110-120V	hp	½	¾	1	1½	2	3	5	8	10	
	200V	hp	1	2	2	3	3	5	7½	-	20	
	220-240V	hp	1½	2	3	3	5	7½	10	20	20	
Fuse / Short-circuit current		A/kA	30/5	40/5	50/5	60/5	110/5	175/5	175/5	-	300/5	
Rated voltage		V	600	600	600	600	600	600	600	600	600	
Auxiliary Contacts (cULus)			A600	A600	A600	A600	A600	-	-	A600	A600	

Contactors for North America

Data according to UL508

Type	K3-90	K3-115	K3-116	K3-151	K3-176	K3-210	K3-260	K3-316	K3-450	K3-550	K3-700	K3-860	K3-1000	K3-1200
A	160	200	150	180	220	250	300	350	420	520	700	810	-	1215
hp	15	20	-	-	-	-	-	-	-	-	-	-	-	-
hp	25	35	30	40	50	60	75	100	125	150	200	250	-	450
hp	35	40	40	50	60	75	100	125	125	150	250	300	-	450
hp	-	-	-	-	-	-	-	-	-	-	-	-	-	-
hp	50	60	-	-	-	-	-	-	-	-	-	-	-	-
hp	65	75	75	100	125	150	200	250	250	350	500	600	-	900
hp	85	100	100	125	150	200	250	300	250	350	500	600	-	900
hp	8	10	10	15	25	-	-	-	-	-	-	-	-	-
hp	15	20	20	-	-	-	-	-	-	-	-	-	-	-
hp	20	25	-	25	30	40	50	50	-	-	-	-	-	-
hp	20	25	-	-	-	-	-	-	-	-	-	-	-	-
hp	30	40	-	-	-	-	-	-	-	-	-	-	-	-
hp	40	50	-	-	-	-	-	-	-	-	-	-	-	-
hp	50	60	-	-	-	-	-	-	-	-	-	-	-	-
A	-	-	-	-	-	-	-	-	-	-	-	-	-	-
hp	-	-	-	-	-	-	-	-	-	-	-	-	-	-
hp	-	-	-	-	-	-	-	-	-	-	-	-	-	-
hp	-	-	-	-	-	-	-	-	-	-	-	-	-	-
hp	-	-	-	-	-	-	-	-	-	-	-	-	-	-
A	-	-	-	-	-	-	-	-	-	-	-	-	-	-
A/kA	300/10	300/10	225/10	300/10	350/10	400/18	500/18	500/18	1200/18	1200/18	2000/30	2000/30	-	2000/42
A/kA	300/100 ³⁾	300/100 ³⁾	-	-	-	-	-	-	-	-	-	-	-	-
V	600	600	600	600	600	600	600	600	600	600	600	600	-	600
	-	-	-	-	-	-	-	-	A600	A600	A600	A600	-	A600

Main Contacts (cULus)	Type	K3-18NK	K3-18NBK	K3-24K	K3-32K	K3-50K	K3-62K	K3-74K	K3-90K	K3-115K	
Rated operational power of 3-phase cap. banks 110-120V at 60Hz (3ph)	200V	kVAr	0-3,5	0-3,5	3-5,5	3-7	6,5-10	6,5-15	6,5-18 ¹⁾	10-24	10-28 ²⁾
	220-240V	kVAr	0-6	0-6	4,5-10	4,5-12,5	10-16,7	10-25	10-32 ¹⁾	17-40	17-46 ²⁾
		kVAr	0-7	0-7	5,5-11	5,5-15	12,5-20	12,5-30	12,5-36 ¹⁾	20-47	20-56 ²⁾
	440-480V	kVAr	0-15	0-15	11,5-25	11,5-30	25-40	25-60	25-72 ¹⁾	40-95	40-114 ²⁾
550-600V	kVAr	0-18	0-18	14,5-30	14,5-35	31-50	31-75	31-90 ¹⁾	50-120	50-143 ²⁾	
Fuse Class RK5 / Short-circuit current	A/kA	70/5	70/5	90/5	125/5	200/5	250/5	300/5	300/10	300/10	
Fuse Class T / Short-circuit current	A/kA	80/100	80/100	110/100	150/100	175/100	175/100	175/100	300/100 ³⁾	300/100 ³⁾	
Rated voltage	V	600	600	600	600	600	600	600	600	600	
Auxiliary Contacts (cULus)		A600	A600	-	-	-	-	-	-	-	

1) Consider the max. thermal current of the contactor K3-74A: I_{th} 130A

2) Consider the min. cross-section of conductor at max. load

3) Class T and Class RK1

Contactors

Data according to IEC 947-4-1, EN 60947-4-1, VDE 0660

Contact Life

For selection of the suitable contactor-type according to supply voltage, power rating and application (utilization category AC1, AC3 or AC4) use contact life characteristic diagram.

For the most common supply voltages four scales of power ratings P_n are provided for each utilization category.

Select contactor-type according to utilization category **AC3** (breaking current $I_a = I_e$) using the **motor rating** scales to the right, according to utilization category **AC4** (breaking current $I_a = 6 \times I_e$) using the **motor rating** scales to the left. ¹⁾

Select contactor-type according to utilization category **AC1** (breaking current $I_a = I_e/AC1$) using the **breaking current** scale. ¹⁾

For contactors frequently used under AC3/AC4-mixed service conditions calculate contact life with the formula:

$$M = \frac{AC3}{1 + \frac{\%AC4}{100} \times \left(\frac{AC3}{AC4} - 1 \right)}$$

M = Contact life (switching cycles) for AC3/AC4-mixed operations
 AC3 = Contact life (switching cycles) for AC3 operations (normal switching conditions). Breaking current $I_a =$ rated motor current I_e .
 AC4 = Contact life (switching cycles) for AC4 operations (inching). Breaking current $I_a =$ multiples of rated motor current I_e .
 %AC4 = Percents of AC4-operations related to the total cycles.

Motor Rating

$P_n = AC4$

660/ 500V 380/ 220/
690V 400V 230V

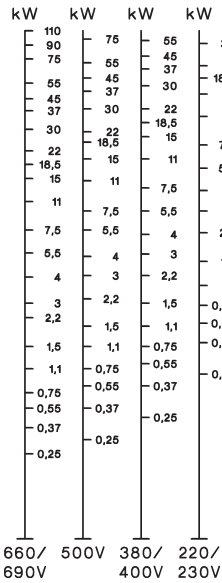

Motor Rating

$P_n = AC3$

660/ 500V 380/ 220/
690V 400V 230V

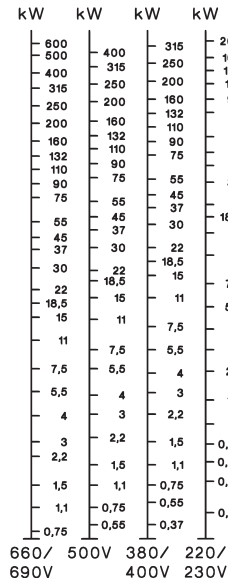

Breaking Current

$I_a (= I_e = AC1)$

A

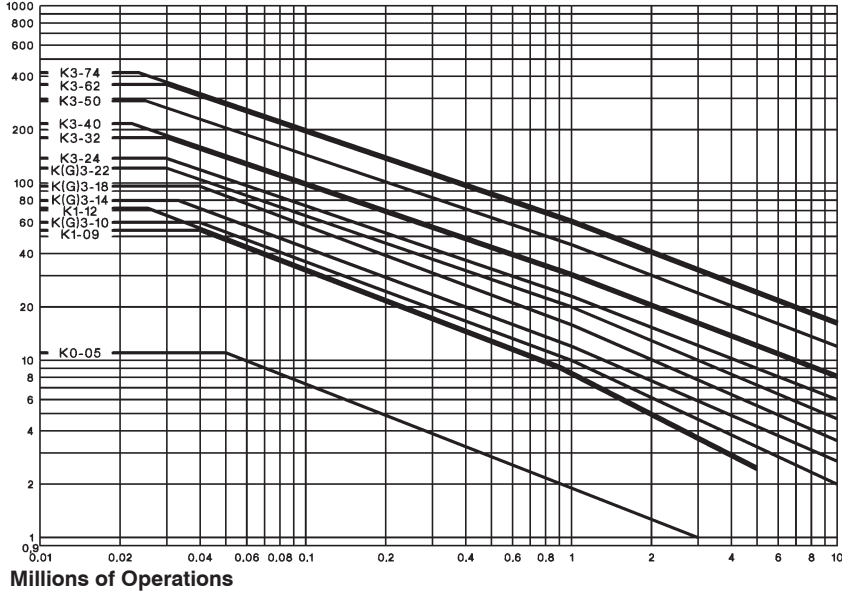

Motor Rating

$P_n = AC4$

660/ 500V 380/ 220/
690V 400V 230V

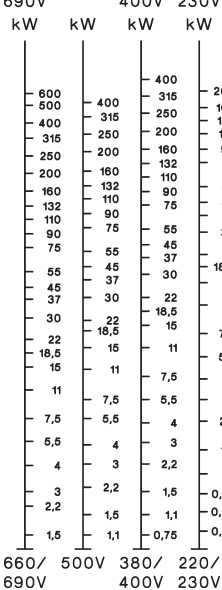

Motor Rating

$P_n = AC3$

660/ 500V 380/ 220/
690V 400V 230V

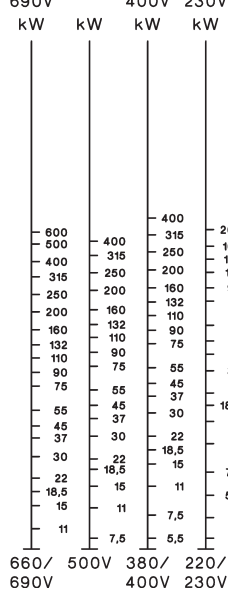

Breaking Current

$I_a (= I_e = AC1)$

A

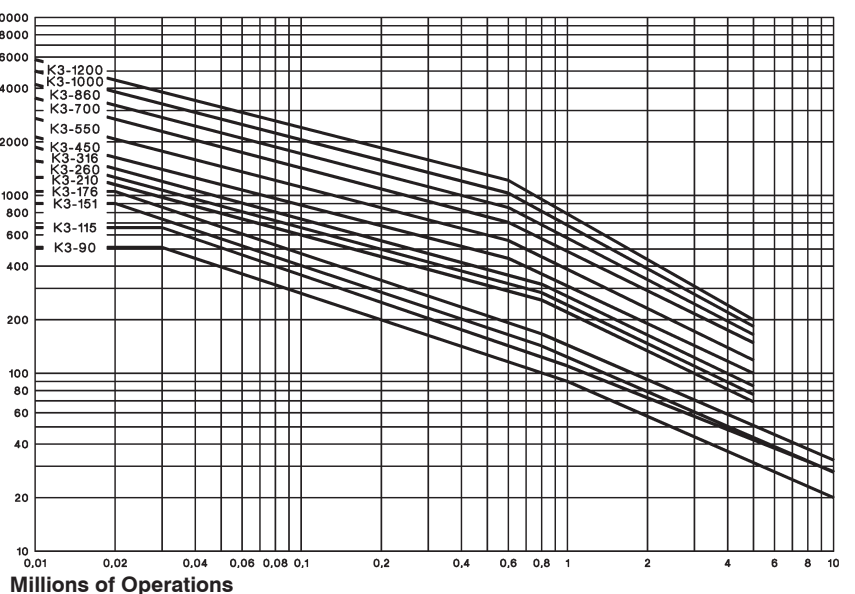

1) Pay attention to the approved rated values of the selected contactor according to the national approvals

Contactors

Utilization Categories

For easier choice of devices and in order to make the comparison of different products simpler are utilization categories for contactors and motor-starters according to IEC 947-4-1 and VDE 0660 Part

102, for control circuit devices and switching elements according to IEC 947-5-1 and VDE 0660 Part 200 determined. The table offers different utilization categories, typical applications and assorted test conditions.

Type of current	Category	Typical applications	Rated operational current	Test conditions for the number of on-load operating cycles						Test conditions for making and breaking capacities					
				Make			Break			Make			Break		
				I/I _e	U/U _e	cosφ	I _c /I _e	U _c /U _e	cosφ	I/I _e	U/U _e	cosφ	I _c /I _e	U _c /U _e	cosφ
Alternating Current	AC1	Non-inductive or slightly inductive loads resistance furnaces	all values	1	1	0,95	1	1	0,95	1,5	1,05	0,8	1,5	1,05	0,8
	AC2	Slip-ring motors: starting, switching off	all values	2,5	1	0,65	2,5	1	0,65	4	1,05	0,65	4	1,05	0,65
	AC3	Squirrel-cage motors: starting, switching off motors during running	17A < I _e < 17A 100A < I _e < 100A 100A < I _e < 100A	6 1 0,65 6 1 0,35 6 1 0,35	1 0,17 0,65 1 0,17 0,35 1 0,17 0,35	10 1,05 0,45 10 1,05 0,45 10 1,05 0,35	8 1,05 0,45 8 1,05 0,45 8 1,05 0,35								
	AC4	Squirrel-cage motors: starting, plugging, inching	17A < I _e < 17A 100A < I _e < 100A 100A < I _e < 100A	6 1 0,65 6 1 0,35 6 1 0,35	6 1 0,65 6 1 0,35 6 1 0,35	12 1,05 0,45 12 1,05 0,45 12 1,05 0,35	10 1,05 0,45 10 1,05 0,45 10 1,05 0,35								
	AC5a	Switching of electric discharge lamp controls	all values	-	-	-	-	-	-	3	1,05	0,45	3	1,05	0,45
	AC5b	Switching of incandescent lamps	all values	-	-	-	-	-	-	1,5	1,05	¹⁾	4	1,05	¹⁾
	AC6a	Switching of transformers	I _e < 100A I _e > 100A	-	-	-	-	-	-	4,5 1,05 0,45 4,5 1,05 0,35	3,6 1,05 0,45 3,6 1,05 0,35				
	AC6b	Switching of capacitors	-	-	-	-	-	-	-	²⁾	²⁾				
	AC7a	Slightly inductive loads in household appliances and similar applications	all values	-	-	-	-	-	-	1,5	1,05	0,8	1,5	1,05	0,8
	AC7b	Motor loads for household applications	I _e < 100A I _e > 100A	-	-	-	-	-	-	8 1,05 0,45 8 1,05 0,35	6 1,05 0,45 6 1,05 0,35				
	AC8a	Hermetic refrigerant compressor motor control with manual resetting of overload releases	I _e < 100A I _e > 100A	-	-	-	-	-	-	6 1,05 0,45 6 1,05 0,35	6 1,05 0,45 6 1,05 0,35				
	AC8b	Hermetic refrigerant compressor motor control with automatic resetting of overload releases	I _e < 100A I _e > 100A	-	-	-	-	-	-	6 1,05 0,45 6 1,05 0,35	6 1,05 0,45 6 1,05 0,35				
	AC12	Control of resistive loads and solid state loads with isolation by opto couplers	all values	-	-	-	-	-	-	1	1	0,9	1	1	0,9
	AC13	Control of solid state loads with transformer isolation	all values	-	-	-	-	-	-	10	1,1	0,65	1,1	1,1	0,65
	AC14	Control of small electromagnetic loads (≤72VA)	-	-	-	-	-	-	-	6	1,1	0,7	6	1,1	0,7
AC15	Control of electromagnetic load (>72VA)	-	10	1	0,7	1	1	0,4	10	1,1	0,3	10	1,1	0,3	
Direct Current	DC1	Non-inductive or slightly inductive loads resistance furnaces	all values	1	1	1	1	1	1	1,5	1,05	1	1,5	1,05	1
	DC3	Shunt-motors: starting, plugging, inching dynamic braking of d.c. motors	all values	2,5	1	2	2,5	1	2	4	1,05	2,5	4	1,05	2,5
	DC5	Series-motors: starting, plugging, inching dynamic braking of d.c. motors	all values	2,5	1	7,5	2,5	1	7,5	4	1,05	15	4	1,05	15
	DC6	Switching of incandescent lamps	all values	-	-	-	-	-	-	1,5	1,05	¹⁾	4	1,05	¹⁾
	DC12	Control of resistive loads and solid state loads with isolation by opto couplers	all values	-	-	-	-	-	-	1	1	1	1	1	1
	DC13	Control of electromagnets	all values	1	1	≤300	1	1	≤300	1,1	1,1	≤300	1,1	1,1	≤300
	DC14	Control of electromagnetic loads having economy resistors in circuit	all values	-	-	-	-	-	-	10	1,1	15	10	1,1	15

1) Test with incandescent lamps

2) Test conditions according to standard

Accessories

Data according to IEC 947-5-1, EN 60947-5-1, VDE 0660

Type		HN	HTN	HA	HB	HKT	HKA	HKF HKB	K2-DK K2-SK	K2-L ²⁾
Rated insulation voltage U_i ¹⁾	V AC	690	690	690	690	690	690	690	690	690
Thermal rated current I_{th} to bis 690V										
Ambient temperature	max. 40°C A	10	10	25	10	10	10	16	26	10
	max. 60°C A	6	6	20	6	-	-	-	-	6
Frequency of operations z	1/h	3000	-	3000	3000	-	-	-	-	3000
Mechanical life	$S \times 10^6$	10	10	10	10	-	-	-	-	10
Power loss per pole at $I_n/AC1$	W	0,5	0,5	1,5	0,5	-	-	-	-	-
Utilization category AC15										
Rated operational current I_e	220-240V A	3	3	6	3	3	3	3	-	3
	380-400V A	2	2	3	2	2	2	2	-	2
	440V A	1,6	1,6	2	1,6	1,5	1,5	1,5	-	1,6
	500V A	1,2	1,2	2	1,2	1,5	1,5	1,5	-	1
	660-690V A	0,6	0,6	1	0,6	1	1	1	-	0,5
Utilization category DC13										
Rated operational current I_e	24V A	2	2	8	2	5	4	6	-	2
	48V A	2	2	8	2	2	1,5	3	-	2
	60V A	2	2	8	2	-	-	-	-	2
	110V A	0,4	0,4	1	0,4	0,8	0,5	1	-	0,4
	220V A	0,1	0,1	0,1	0,1	0,4	0,2	0,5	-	0,1
Short circuit protection short-circuit current 1kA, contact welding not accepted max. fuse size	gL (gG) A	20	20	25	20	10	10	10	-	10
For contactors with thermal overload relay or auxiliary contacts the device with the smaller admissible control fuse (contactor or thermal overload relay) determines the fuse size.										
Cable cross-sections										
solid or stranded	mm ²	0,75-2,5	0,75-2,5	0,75-2,5	0,75-2,5	0,75-2,5	0,75-2,5	0,75-2,5	0,75-2,5	0,75-2,5
flexible	mm ²	0,75-2,5	0,75-2,5	0,75-2,5	0,75-2,5	0,75-2,5	0,75-2,5	0,75-2,5	0,75-2,5	0,75-2,5
flexible with multicore cable end	mm ²	0,5-1,5	0,5-1,5	0,5-1,5	0,5-1,5	0,5-1,5	0,5-1,5	0,5-1,5	0,5-1,5	0,5-1,5
solid	AWG	14 - 12	14 - 12	14 - 12	14 - 12	14 - 12	14 - 12	14 - 12	14 - 12	14 - 12
flexible	AWG	18 - 12	18 - 12	18 - 12	18 - 12	18 - 12	18 - 12	18 - 12	18 - 12	18 - 12
Cables per clamp		2	2	2	2	2	2	2	2	2

Data according to CSA, UL and CUL

Type		HN	HTN	HA	HB..	HKA, HKT HKF	K2-DK K2-SK	K2-L ²⁾
Rated operational current "General Use"	A	10	10	16	10	10	-	-
Rated operational voltage	max. V AC	600	600	600	600	600	-	600
Auxiliary Contacts		A600	A600	A600	A600	A600	-	Intermittent duty

1) Suitable for: earthed-neutral systems, overvoltage category I to IV, pollution degree 3 (standard-industry): $U_{imp} = 8kV$. Data for other conditions on request.

2) Command duration min. 30ms, 10% duty cycle, max. 30 sec.

Contactors and Accessories

Wiring diagrams

Auxiliary contact blocks

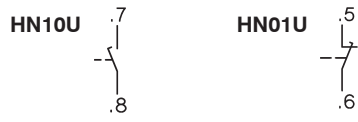
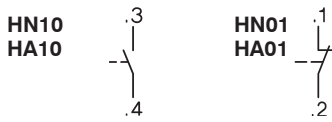

Snap-on momentary contact blocks

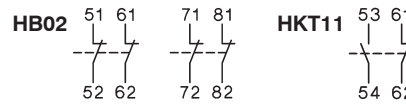
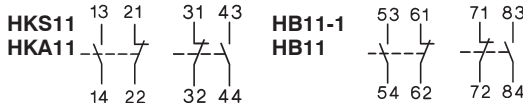
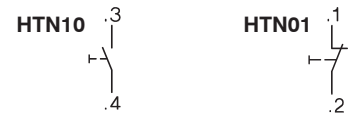

HB11, HB02:
Correct terminal marking
is given by mounting.

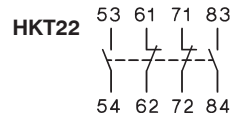
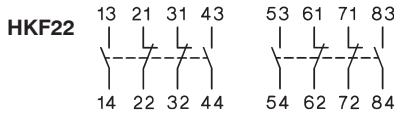

Indicator units

Electronic timer

K3-T180 240

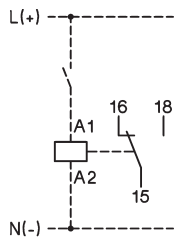

Coil current indicator

K2-ING K2-INR

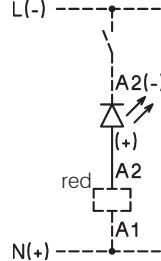

Voltage indicator

K2-UN K2-UNR

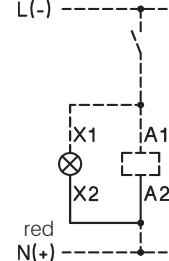

Latch

K2-L..

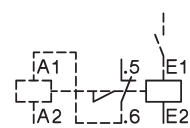

Fuse holder

K2-F



with rectifier

K2-RF1 K2-RF3

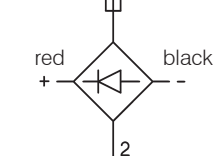

Colours mentioned in
wiring diagram refer to
the outgoing
connection wires
of the device.

Regulation of switch position of aux. contact block HKF22 for contactors K3-450 to K3-860

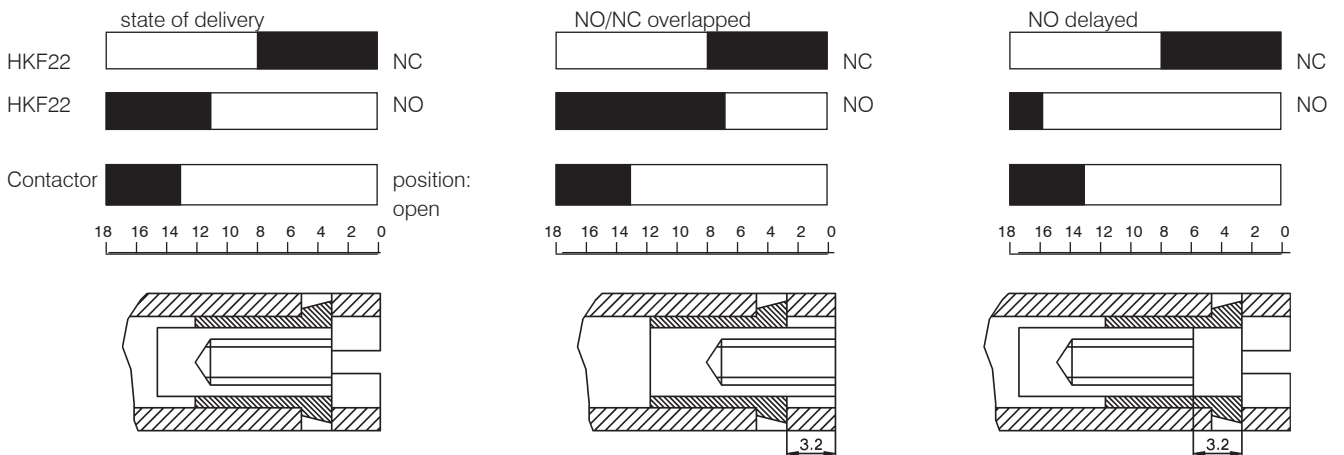

Contactors

Dimensions

AC operated

K3-10N..
K3-14N..
K3-18N..
K3-22N..

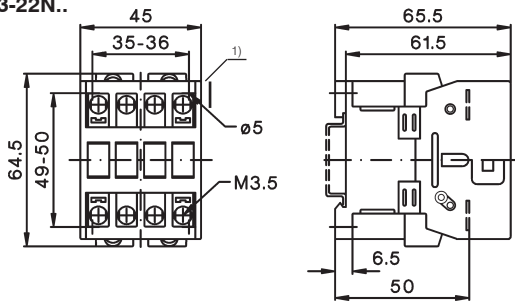

K3-24..
K3-32..
K3-40..

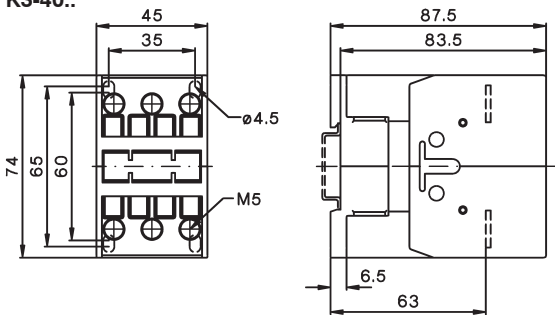

K3-50..
K3-62..
K3-74..

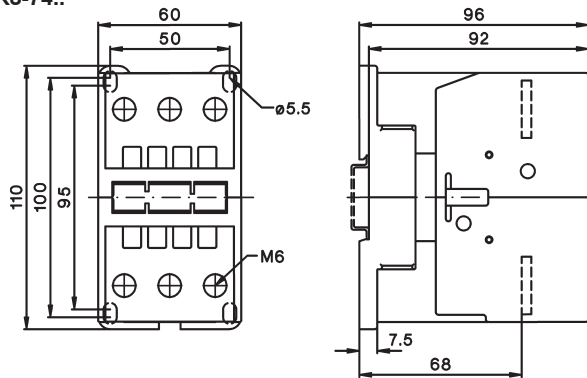

AC and DC operated

K3-90..
K3-115..

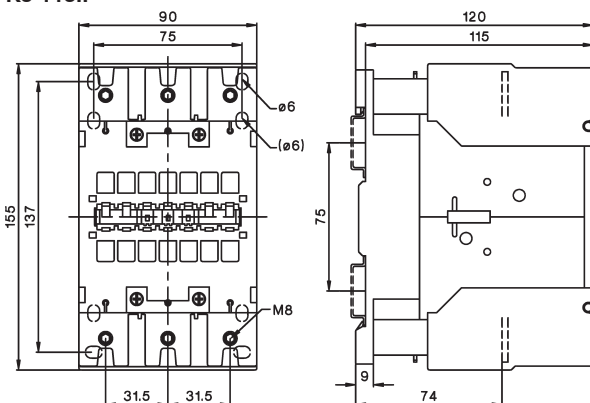

DC operated

KG3-10..
KG3-14..
KG3-18..
KG3-22..

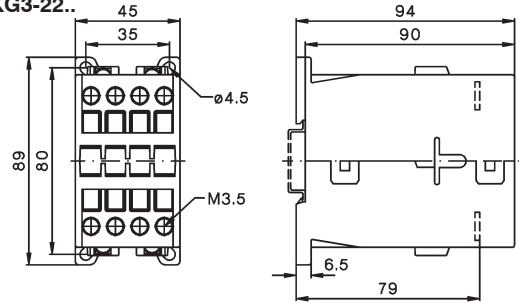

KG3-24..
KG3-32..
KG3-40..

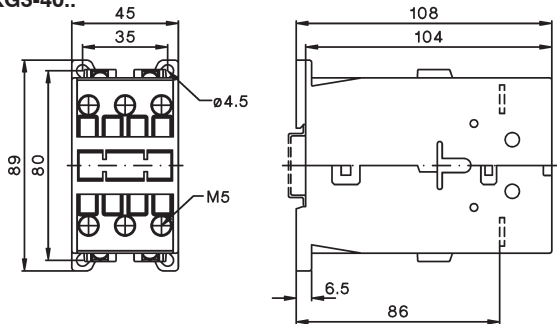

K3-50..=
K3-62..=
K3-74..=

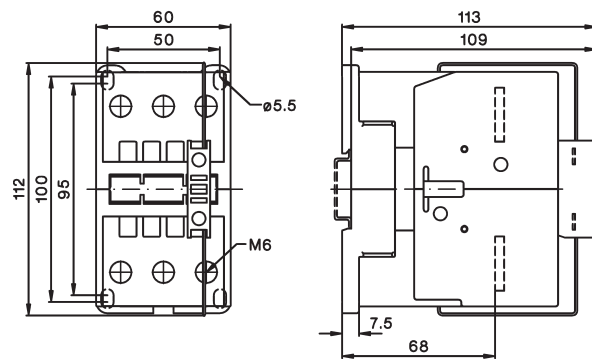

1) Minimum side distance to
conductive parts for coil voltage:
500V $U_{imp}=6kV$ 2mm
660-690V $U_{imp}=8kV$ 4,5mm

Contactors

Dimensions, AC operated, DC operated

K3-151..
K3-176..

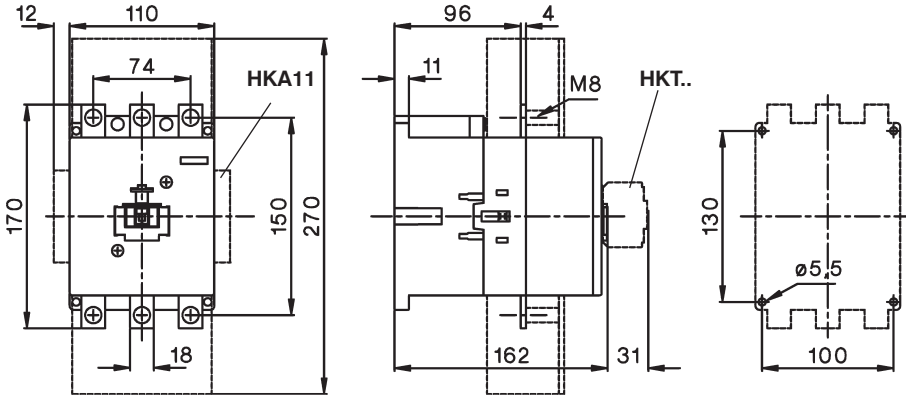

K3-210..
K3-260..
K3-316..

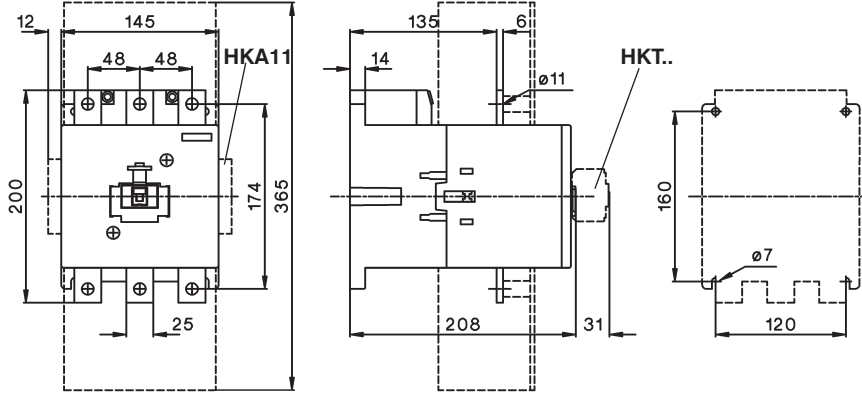

K3-450..
K3-550..

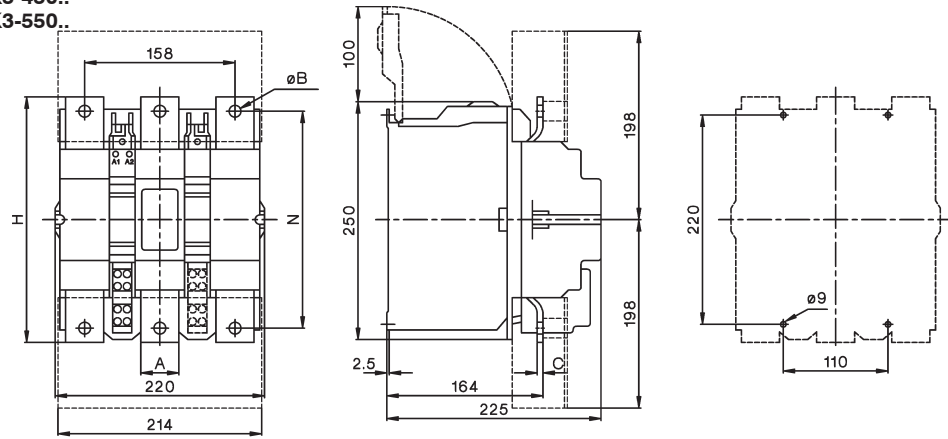

Type	A	B	C	H	N
K3-450	40	10,5	4	233	206
K3-550	40	12,5	6	258	228

K3-700..
K3-860..

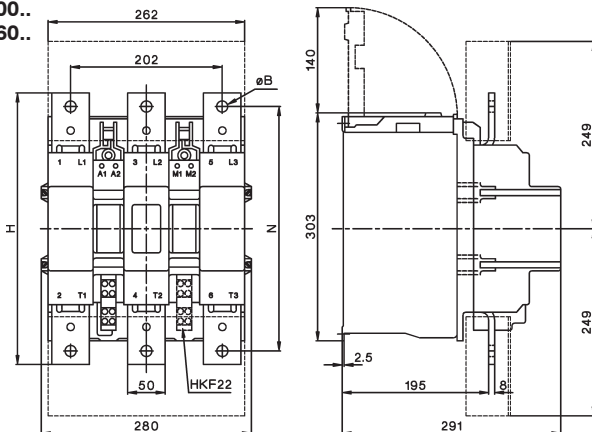

Type	B	H	N
K3-700	13	310	277
K3-860	15	361	325

Contactors

Dimensions

AC operated, DC operated

K3-1000..

K3-1200..

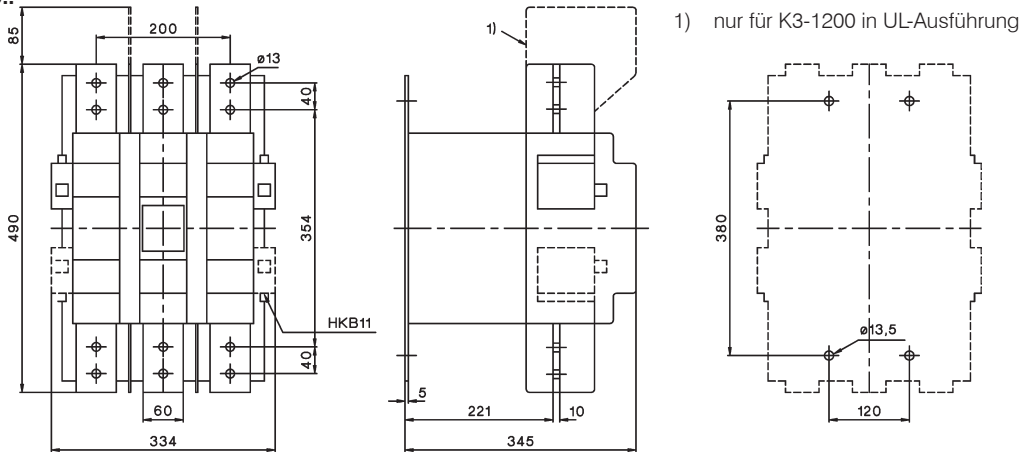

Capacitor Switching Contactors, AC operated

K3-18NK..

K3-18NBK..

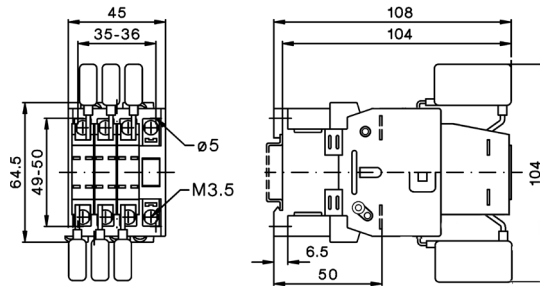
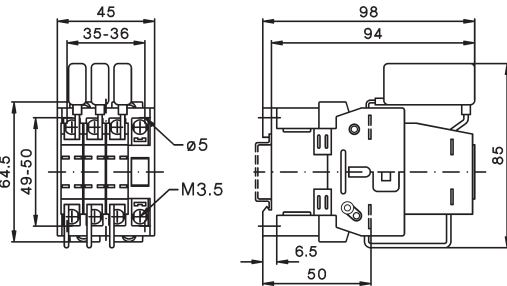

K3-24K..

K3-32K..

K3-50K..

K3-62K..

K3-74K..

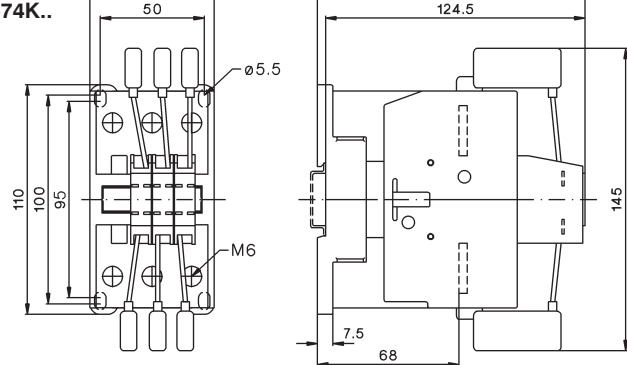
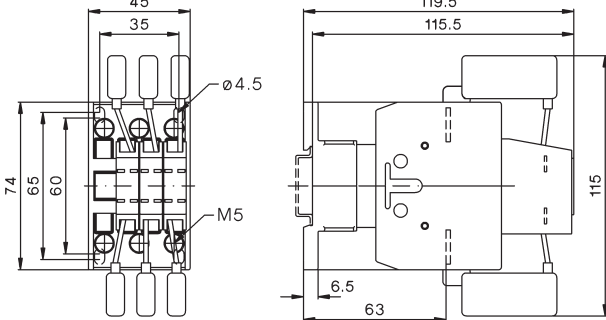

K3-90K..

K3-115K..

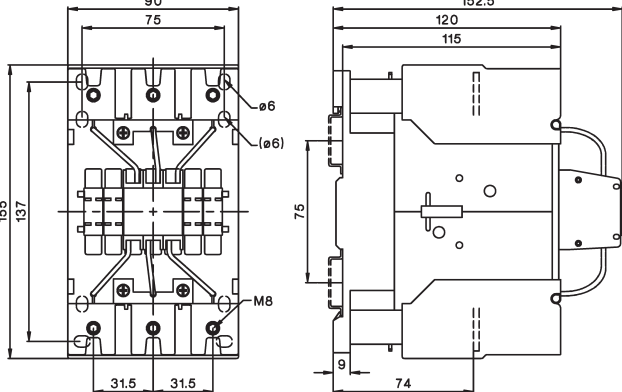

Contactors

Dimensions

Contactors DC operated

- K3-10N..=
- K3-14N..=
- K3-18N..=
- K3-22N..=

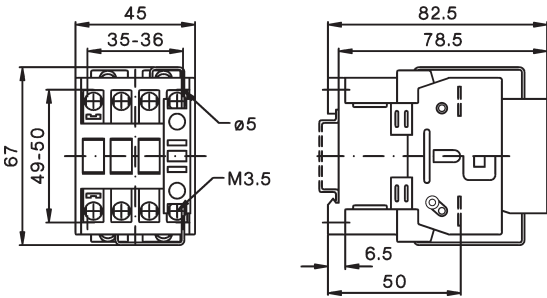

- K3-24..=
- K3-32..=
- K3-40..=

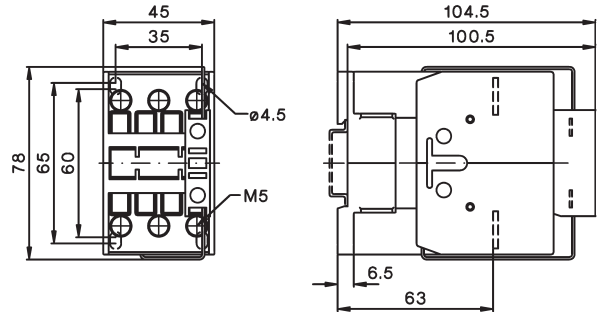

Contactors 4-pole, AC operated / DC operated

- K3-10NA00-40
- K3-14NA00-40
- K3-18NA00-40
- K3-22NA00-40

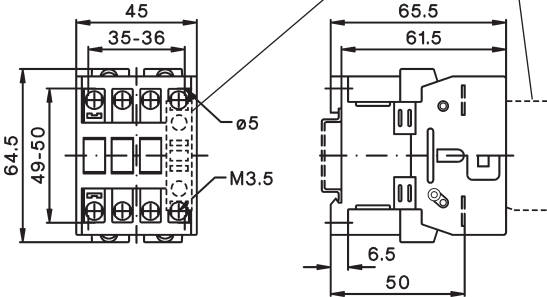

- K2-23A00-40
- K2-30A00-40
- K2-37A00-40

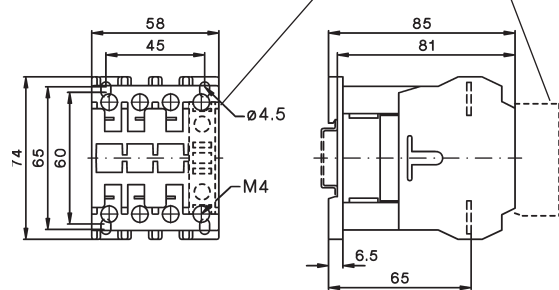

Contactors 4-pole, AC operated / DC operated

- K3-50A00-40
- K3-62A00-40
- K3-74A00-40

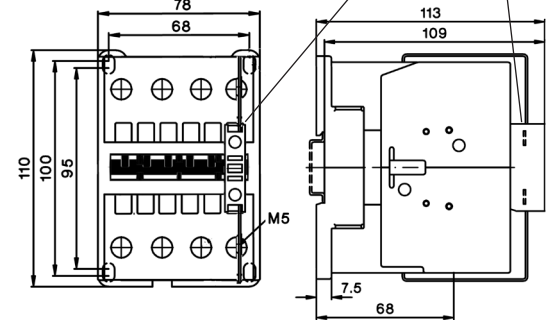

- K3-41A00-40

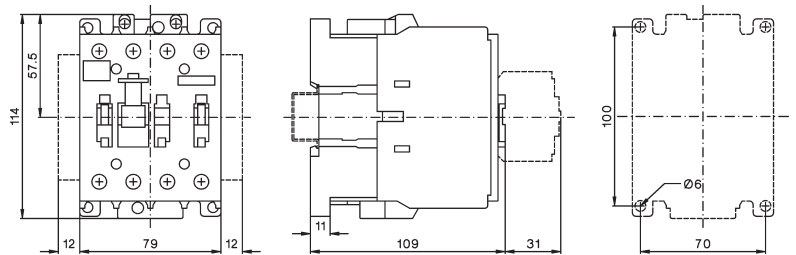

- K3-96A00-40

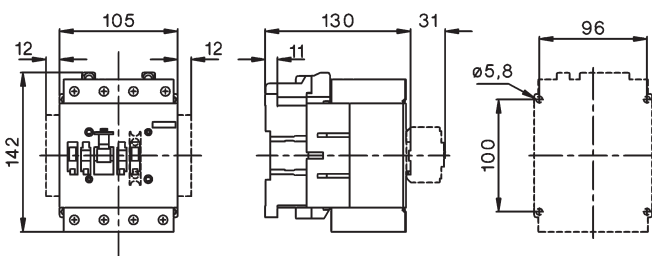

- K3-116A00-40
- K3-151A00-40

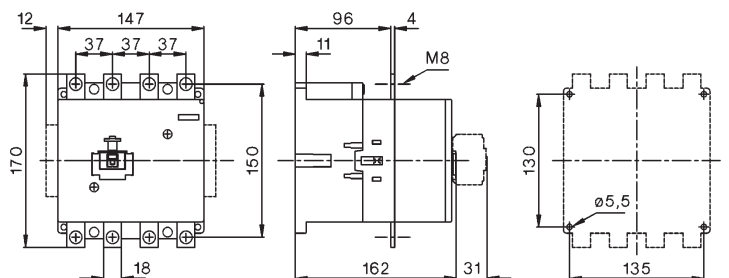

Contactors

Contactors 4-pole, AC and DC operated

K3-210A00-40
K3-260A00-40
K3-316A00-40

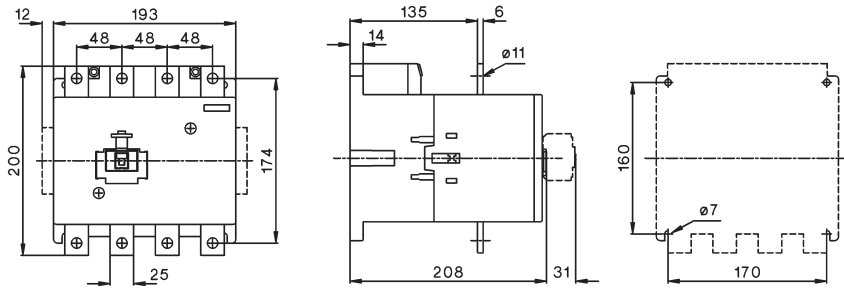

Dimensions Accessories

Aux. cont. blocks, terminal blocks

Snap-on momentary cont. blocks

Auxiliary contact blocks

HN10, HN01

K2-SK, K2-DK

HTN10, HTN01

HA10, HA01

HB11-1, HB11, HB02

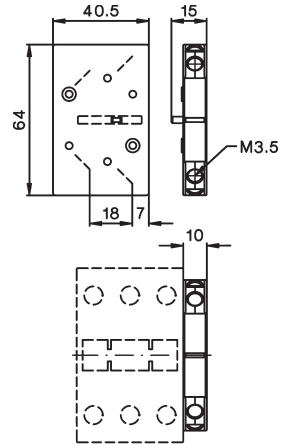
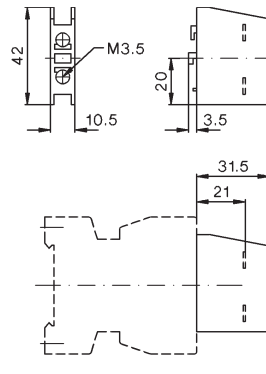
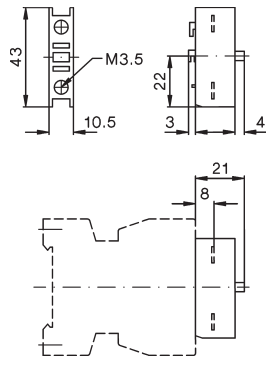
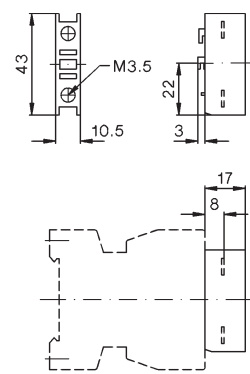

4. pole for contactors K3-200 to K3-1200

Type	A	B	C	D	E	F	G	H
NP175	223	148	26	52	98	5	122	M8
NP350	223	148	26	52	98	5	122	M8
NP325	262	148	26	55	116	5	122	M10
NP500	294	220	53	72	138	5	152	M12
NP760	294	220	53	72	138	5	152	M12
NP501	348	220	53	73	145	5	152	M12
NP1000	348	220	53	73	145	8	152	M12
NP1001	410	220	53	110	157	8	152	M12

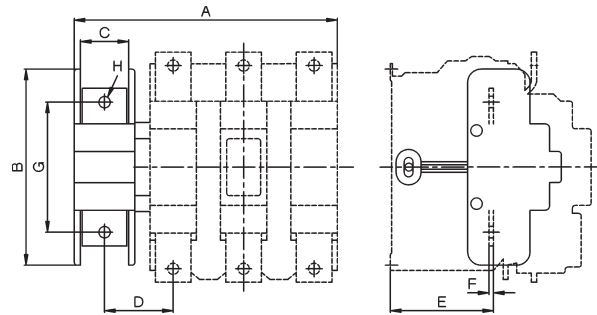

Electronic timer

K3-T180 240

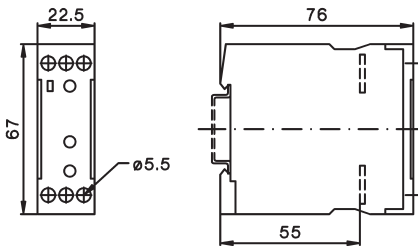

Electronic timer on-delay

K2-TE..

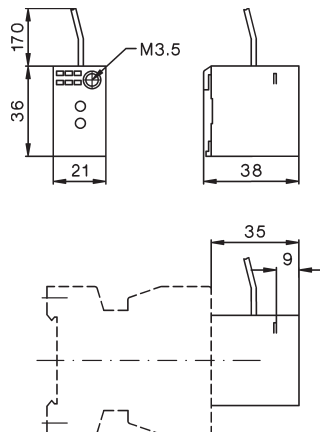

Contactors

Dimensions Accessories

Mechanical interlocks

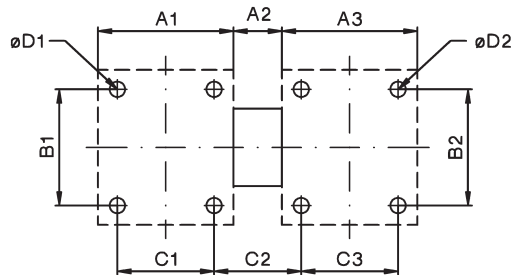

Type	Contactor 1	Contactor 2	A1	A2	A3	B1	B2	C1	C2	C3	D1	D2	
LG10889	K3-07 to K3-40	K3-07 to K3-40	45	7	45	50	50	35	17	35	4,5	4,5	
LG10889	KG3-07 to KG3-22	KG3-07 to KG3-22	45	7	45	80	50	35	17	35	4,5	4,5	
LG10889	KG3-24 to KG3-40	KG3-22 to KG3-40	45	7	45	80	50	35	17	35	4,5	4,5	
LG10890	K3-50 to K3-74	K3-24 to K3-40	60	12	55	100	65	50	22	45	5,5	4,5	
LG10890	K3-50 to K3-74	K3-50 to K3-74	60	12	60	100	100	50	22	50	5,5	5,5	
LG11478	K3-90 to K3-115	K3-90 to K3-115	90	12	90	100	100	75	27	75	5,5	5,5	
LG8511	K65 - K110	K65 - K110	90	12	90	100	100	75	27	75	6	6	
LG11223H	K3-151, -176	K3-151, -176	110	30	110	130	130	100	40	100	6	6	3-pole contactor
LG11223H	K3-116,-151, -176	K3-116,-151, -176	147	30	147	130	130	135	42	135	6	6	4-pole contactor
LG11223H	K3-210, -260, -316	K3-210, -260, -316	145	30	145	160	160	120	55	120	6	6	3-pole contactor
LG11223H	K3-210, -260, -316	K3-210, -260, -316	193	30	193	160	160	170	55	170	6	6	4-pole contactor
LG10400H	K3-450, K3-550	K3-450, K3-550	220	42	220	220	220	110	152	110	9	9	
LG10402H	K3-700, -860	K3-700, -860	280	32	280	280	280	175	137	175	11	11	
LG10403H	K3-1000, -1200	K3-1000, -1200	334	46	334	380	380	120	260	120	13,5	13,5	
LG10399H	K3-450, -550	K3-700, -860	220	37	280	220	280	110	144,5	175	9	11	
LG10401H	K3-700, -860	K3-1000, -1200	280	73	334	280	380	175	232,5	120	11	13,5	

LG10400V, LG10402V

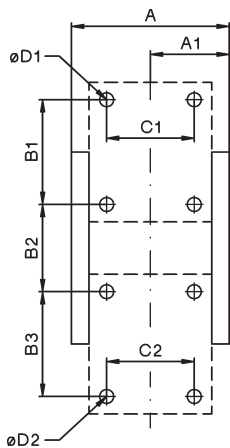

LG10399V

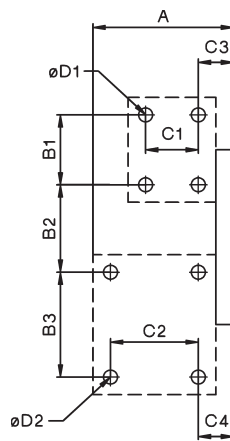

LG10403V, LG10401V

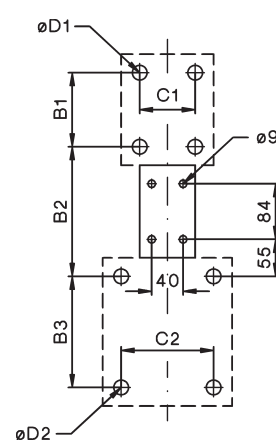

Type	Contactor 1	Contactor 2	A	A1	B1	B2	B3	C1	C2	C3	C4	D1	D2
LG10400V	K3-315 - K3-550	K3-315 - K3-550	250	134	220	94	220	110	110	-	-	9	9
LG10402V	K3-700, -860	K3-700, -860	302	162	280	200	280	175	175	-	-	11	11
LG10403V	K3-1000, -1200	K3-1000, -1200	-	-	380	280	380	120	120	-	-	13,5	13,5
LG10399V	K3-450, -550	K3-700, -860	302	-	220	150	280	110	175	51	74,5	9	11
LG10401V	K3-700, -860	K3-1000, -1200	-	-	280	240	380	175	120	-	-	11	13,5

Contactors

Dimensions Accessories

Latch

K2-L..

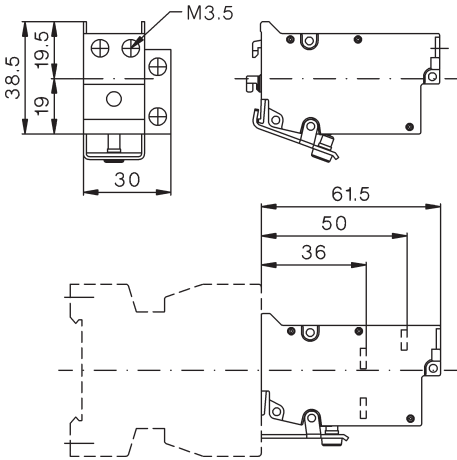

Contactors with additional terminals

LG9339N (2 x 3 pieces)
for K3-10N. to K3-22N.

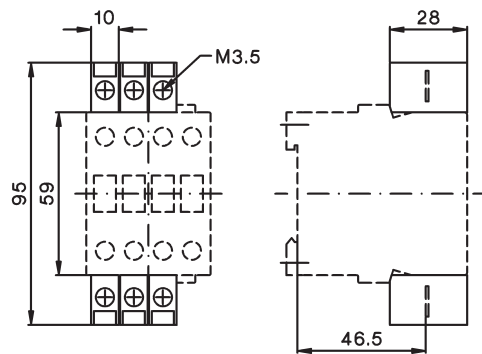

Indicator units

K2-ING, K2-INR
K2-UN, K2-UNR

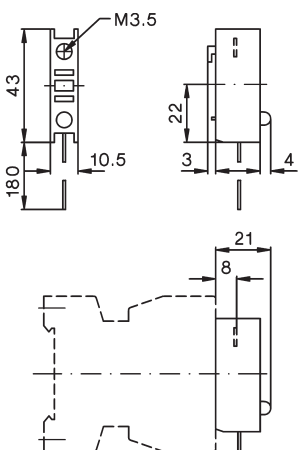

Fuse holder

K2-RF

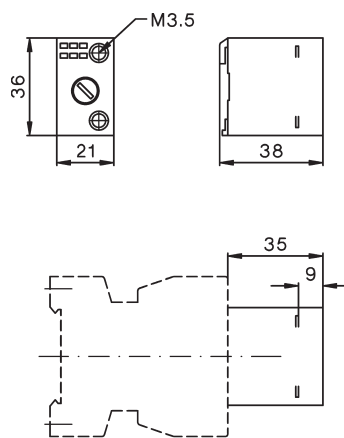

Fuse holder with rectifier

K2-RF1
K2-RF3

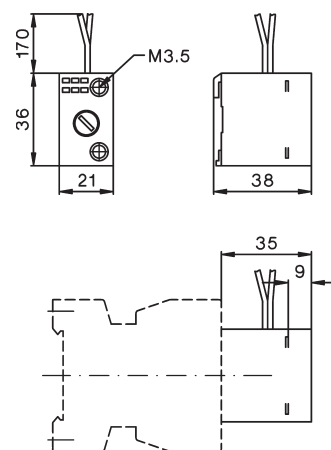

Contactors

Dimensions Accessories

Snap-on adapter

K2-SM

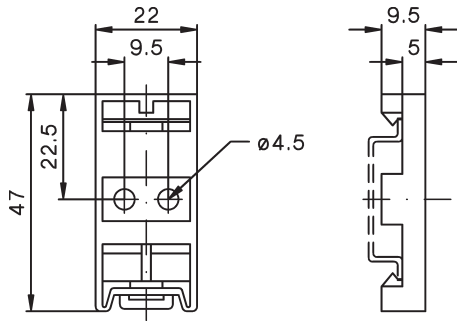

Suppressor units

RC-K3N ..

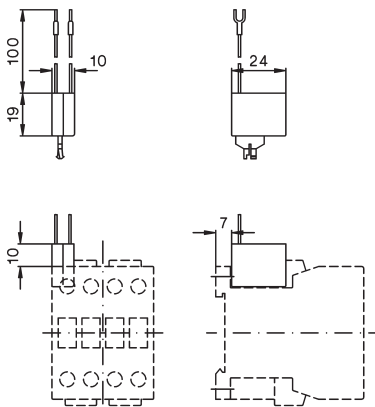

RC-K3NW ..

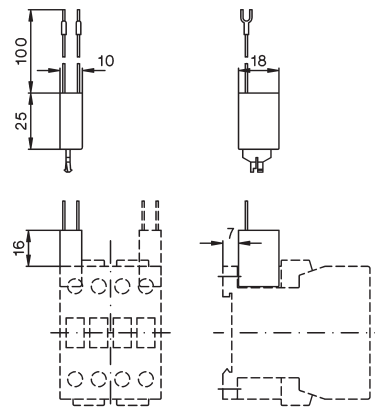

Marking systems

marking label

P487-1 or **P245-**

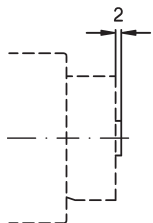

Contactors

Position of terminals

K3-10ND10
K3-14ND10
K3-18ND10
K3-22ND10
K3-18NK10

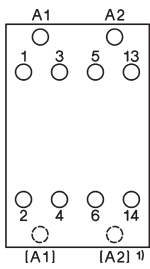

K3-10ND01
K3-14ND01
K3-18ND01
K3-22ND01
K3-18NK01

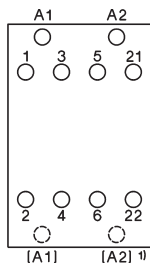

K3-24A00, K3-24K00
K3-32A00, K3-32K00
K3-40A00

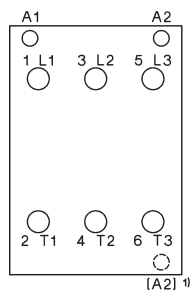

K3-50A00, K3-50K00
K3-62A00, K3-62K00
K3-74A00, K3-74K00

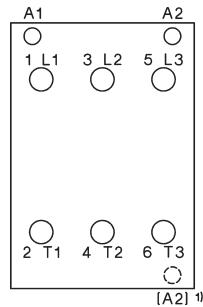

K3-10NA00-40
K3-14NA00-40
K3-18NA00-40
K3-22NA00-40
K2-23A00-40 to
K2-60A00-40

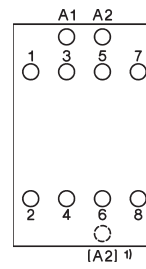

K85A22
K110A22

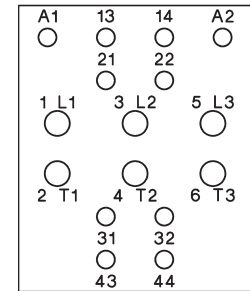

K3-90A00
K3-115A00

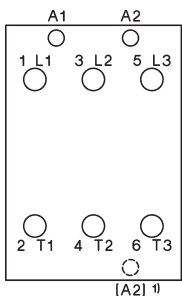

K3-151A00
K3-176A00
K3-210A00
K3-260A00
K3-316A00

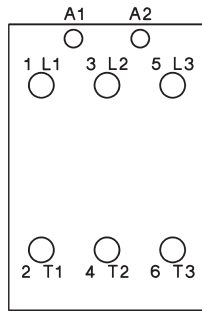

K3-116A00-40
K3-151A00-40
K3-176A00-40
K3-210A00-40
K3-260A00-40
K3-316A00-40

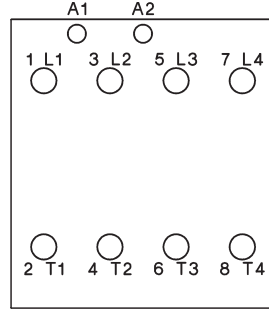

K3-450A22
K3-550A22
K3-700A22
K3-860A22

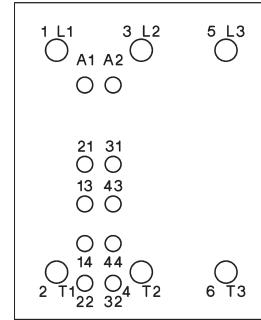

K3-1000A12
K3-1200A12

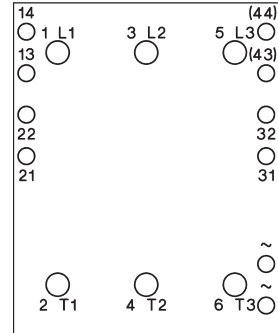

KG3-10A10
KG3-14A10
KG3-18A10
KG3-22A10

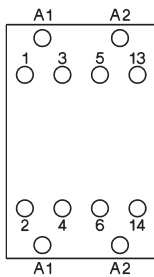

KG3-10A01
KG3-14A01
KG3-18A01
KG3-22A01

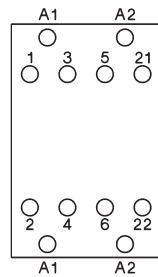

KG3-10A00-40
KG3-14A00-40
KG3-18A00-40
KG3-22A00-40

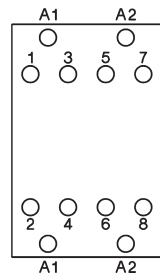

KG3-24A00
KG3-32A00
KG3-40A00

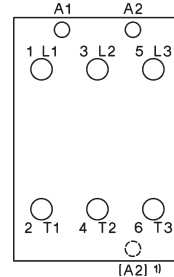

K3-10ND10=
K3-14ND10=
K3-18ND10=
K3-22ND10=

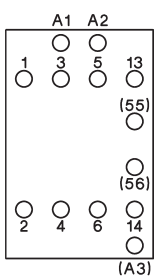

K3-10ND01=
K3-14ND01=
K3-18ND01=
K3-22ND01=

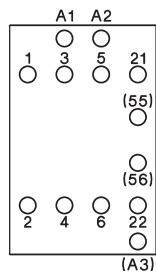

K3-24A00=
K3-32A00=
K3-40A00=

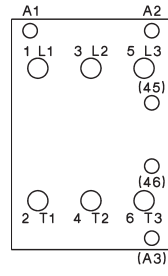

K3-50A00=
K3-62A00=
K3-74A00=

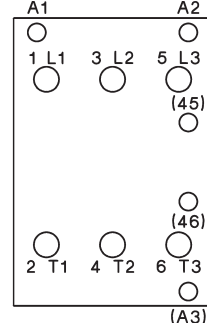

K85A21=
K110A21=

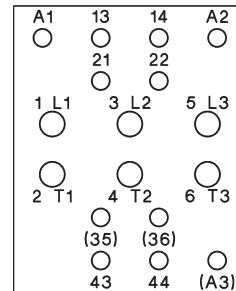

K3-1000A12=
K3-1200A12=

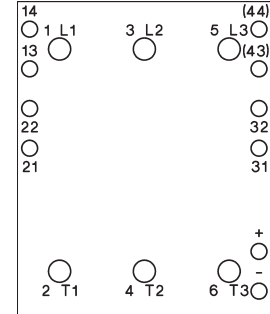

1) Type-suffix "EUR" with additional coil terminal
Ordering example: K3-10ND10 EUR 230

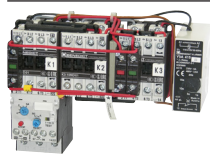

Star-Delta Starters Open Type

92



Star-Delta Starters Enclosed
Enclosure for Star-Delta Starters

94

94

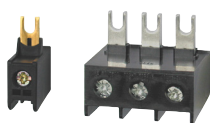

Accessories

95



Reversing Contactors

96



Pole Changing Starters

98



Technical Data

100

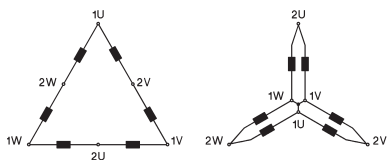

Wiring Diagrams

103

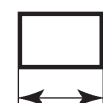

Dimensions

107

Star-Delta Starters Open Type

AC Operated

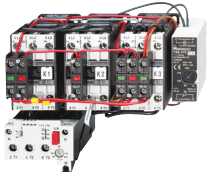

Ratings		Rated Current		order separately	Type	Coil voltage ¹⁾	Pack pcs.	Weight kg/pc.
AC3						220-240V 50Hz		
380V						380-415V 50Hz		
400V	660V	AC3		Overload Relay				
415V	500V	690V	400V					
kW	kW	kW	A	Type				
7,5	7,5	11	16	U3/32 U12/16E K3	K3NY15 ...		1	0,9
15	18,5	15	30		K3NY26 ...		1	0,9
22	30	22	45	U3/42	K3Y40 ...		1	1,4
30	37	30	60		K3Y52 ...		1	1,8
45	55	45	85	U3/74	K3Y80 ...		1	3,5
55	75	55	109		K3Y100 ...		1	3,7
75	90	90	150	U85	K3Y140 ...		1	6,6
110	132	110	205		K3Y200 ...		1	7
132	160	160	240	U180	K3Y240 ...		1	15
160	180	180	300		K3Y300 ...		1	15

Star-delta starters are wired to accept thermal overload relay. The thermal overload relay has to be ordered separately. For full load current setting use the YD-dial of thermal overload relay.

Ordering Example: Star-Delta Starter, open type, rated AC3 at 400V 205A rated control voltage 230V 50Hz - **Order Type: K3Y200 230 + U85 120**

Thermal Overload Relays

Rated Motor Current A	Type	Pack pcs.	Weight kg/pc.	Wiring Diagram
--------------------------	------	-----------	---------------	----------------

For Star-Delta Starters K3NY15.. to K3Y40..



7 - 10,5	U12/16E 6 K3	1	0,10
10,5 - 15,5	U12/16E 9 K3	1	0,10
14 - 19	U12/16E 11 K3	1	0,10
18 - 24	U12/16E 14 K3	1	0,10
23 - 31	U12/16E 18 K3	1	0,10

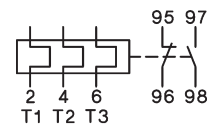

manual reset

For Star-Delta Starters K3NY15.. to K3Y52..



7 - 10,5	U3/32 6	1	0,14
10,5 - 15,5	U3/32 9	1	0,14
14 - 19	U3/32 11	1	0,14
18 - 24	U3/32 14	1	0,14
23 - 31	U3/32 18	1	0,14
30 - 41	U3/32 24	1	0,14
40 - 55	U3/32 32	1	0,14

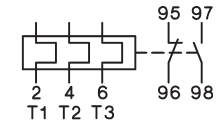

manual and auto reset

For Star-Delta Starters K3Y40.., K3Y52..



24 - 35	U3/42 20	1	0,30
35 - 48	U3/42 28	1	0,30
48 - 73	U3/42 42	1	0,30

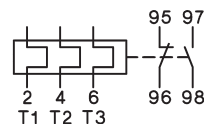

manual and auto reset

1) Coil voltage range and other coil voltages see page 100

Components for Combinations			Electronic Timer	Mechanical Interlock between K2 and K3	Star-Delta Starter Connector Type	Auxiliary Contacts Built-in for use on Contactor			Free Space for Aux. Contact Blocks on Contactor		
Line Contactor	Delta Contactor	Star Contactor				Line K1	Delta K2	Star K3	Line K1	Delta K2	Star K3
K1 Type	K2 Type	K3 Type	K4 Type	K2 and K3 Type							
K3-10ND01 + HN10	K3-10ND01	K3-10ND10 + HN10 + HN01	Y9A	LG10889	K3NY-VB10	-	-	-	3	4	2
K3-18ND01 + HN10	K3-18ND01	K3-14ND10 + HN10 + HN01	Y9A	LG10889	K3NY-VB10	-	-	-	3	4	2
K3-24A00 + HN10 + HN01	K3-24A00 + HN01	K3-24A00 + 2HN10 + HN01	Y9A	LG10889	K3Y-VB24	-	-	-	2	3	1
K3-32A00 + HN10 + HN01	K3-32A00 + HN01	K3-24A00 + 2HN10 + HN01	Y9A	LG10889	K3Y-VB24	-	-	-	2	3	1
K3-50A00 + HN01 + HN10	K3-50A00 + HN01	K3-32A00 + 2HN10 + HN01	Y9A	LG10890	-	-	-	-	2	3	1
K3-62A00 + HN01 + HN10	K3-62A00 + HN01	K3-50A00 + 2HN10 + HN01	Y9A	LG10890	-	-	-	-	2	3	1
K3-90A00 + HN01 + HN10	K3-90A00 + HN01	K3-90A00 + 2HN10 + HN01	Y9AL	LG11478	-	-	-	-	5	6	4
K3-115A00 + HN01 + HN10	K3-115A00 + HN01	K3-90A00 + 2HN10 + HN01	Y9AL	LG11478	-	-	-	-	5	6	4
K3-151A00 + HKT11	K3-151A00 + HKT11	K3-151A00 + HKT22	Y9AL	LG11223H	-	-	1/-	-/1	2	1	1
K3-176A00 + HKT11	K3-176A00 + HKT11	K3-151A00 + HKT22	Y9AL	LG11223H	-	-	1/-	-/1	2	1	1

Applications

The star-delta starting method is only practicable in such cases where the motor windings are connected in delta configuration for normal operation and the torque which is needed during the starting period is not higher than approx. 30% of the rated torque. The starting current drawn from the line will be approx. 2 to 2,7 times the rated motor current.

Time setting

The transition from start (star configuration) to normal operation (delta configuration) should be after the motor achieves practically full rotational speed. The use of star-delta timer Y9A with a dwell period of approx. 25ms provides a careful operation of motor and drive equipment.

Thermal Overload Relays

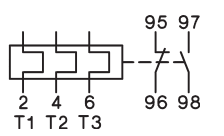
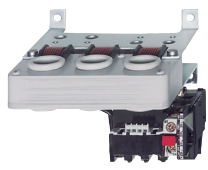
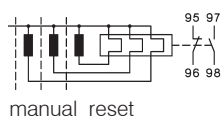
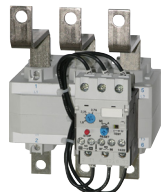
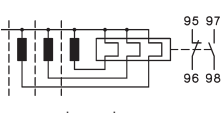
	Rated Motor Current A	Type	Pack pcs.	Weight kg/pc.	Wiring Diagram
	For Star-Delta Starters K3Y80.., K3Y100..				
	35 - 48	U3/74 28	1	0,40	
	48 - 73	U3/74 42	1	0,40	
	70 - 90	U3/74 52	1	0,40	
	90 - 112	U3/74 65	1	0,40	manual and auto reset
	For Star-Delta Starters K3Y140.., K3Y200..				
	104 - 156	U85 90	1	0,90	
140 - 207	U85 120	1	0,90	manual reset	
	For Star-Delta Starters K3Y240.., K3Y300..				
208 - 312	U180 180	1	1,5		
					manual and auto reset

Star-Delta Starters Enclosed Type

AC Operated

Ratings		Rated Current	Optional Extras	Wired to accept Overload Relay	Type	Coil voltage ¹⁾	Pack pcs.	Weight kg/pc.
AC3						220-240V 50Hz		
380V					230	380-415V 50Hz		
400V	660V	AC3			400			
415V	500V	690V	400V		↓			
kW	kW	kW	A	Type				



Plastic Enclosed, protected to IP65

Rated Current (A)	Rated Power (kW)	Rated Voltage (V)	Rated Current (A)	Optional Extras	Wiring	Type	Pack pcs.	Weight kg/pc.
7,5	7,5	11	16	ST	U3/32	K3NY15P ...	1	1,8
15	18,5	15	30	ST		K3NY26P ...	1	1,8
22	30	22	45	ST, H	U3/42	K3Y40P ...	1	3,8
30	37	30	60	ST, H		K3Y52P ...	1	4,2
45	55	45	85	ST, H	U3/74	K3Y80P ...	1	5,9
55	75	55	109	ST, H		K3Y100P ...	1	8,7



Sheet Steel Enclosed, protected to IP54

Rated Current (A)	Rated Power (kW)	Rated Voltage (V)	Rated Current (A)	Optional Extras	Wiring	Type	Pack pcs.	Weight kg/pc.
7,5	7,5	11	16	ST, H	U3/32	K3NY15B ...	1	2,8
15	18,5	15	30	ST, H		K3NY26B ...	1	2,8
22	30	22	45	ST, H	U3/42	K3Y40B ...	1	4,8
30	37	30	60	ST, H		K3Y52B ...	1	5,2
45	55	45	85	ST, H	U3/74	K3Y80B ...	1	15
55	75	55	109	ST, H		K3Y100B ...	1	15
75	90	90	150	ST, H	U85	K3Y140B ...	1	22
110	132	110	205	ST, H		K3Y200B ...	1	22

1) Coil voltage range and other coil voltages see page 100

Type-suffix for optional extras

Start-Stop Push ButtonsT ...
Selector SwitchW ...
Control Circuit Fuse <250V (1 piece)ST ...
>250V (2 pieces)ST ...
Run Hour MeterH ...

Ordering Example: Star-Delta Starter, steel sheet enclosed, with selector switch and run hour meter rated AC3 at 400V 82A, rated control voltage 230V 50Hz - **Order Type: K3Y80BWH 230 + U3/74 52**

Enclosures for Star Delta Starter



for Starter	accept Overload Relay	Type	Pack pcs.	Weight kg/pc.
Plastic IP65				
K3NY15, K3NY26	U3/32	K3Y26P-G3	1	1,0
K3Y40, K3Y52	U3/42, U3/32	K3Y40/52P-G3	1	2,4
Sheet Steel IP54				
K3NY15, K3NY26	U3/32	K3Y26B-G3	1	3,4
K3Y40, K3Y52	U3/42, U3/32	K3Y40/52B-G3	1	3,4

Star-Delta Starter Connector



For Star-Delta Starter Types

	Type	Pack pcs.	Weight kg/pc.
K3NY15, K3NY26	K3NY-VB10	1	0,02
K3Y40, K3Y52	K3Y-VB24	1	0,03

Additional Terminals



For Star-Delta Starter Types
Line Conn. Motor Conn.
Line Contactor Overload Relay

Cable cross-section mm²

Type

Pack pcs. Weight kg/pc.

Single pole with Fingertouch Protection

K3NY15, K3NY26	U12/16	0,75 - 10 solid 0,75 - 6 flex.	LG9339	6	0,009
----------------	--------	-----------------------------------	---------------	---	-------

Three-pole with Fingertouch Protection

	U3/42	4 - 35 strand. 4 - 25 flex.	LG7559	1	0,052
--	-------	--------------------------------	---------------	---	-------

Electronic Timers for Star-Delta Starters¹⁾



Rated Control Voltage V	Time Range s	Delay Time ms	Rated Current AC15		Type	Pack pcs.	Weight kg/pc.
			250V A	400V A			
24 - 60V AC/DC	1 - 20 ²⁾	20 - 25	5	5	Y9A 60	1	0,075
110 - 415V AC/DC	1 - 20 ²⁾	20 - 25	5	5	Y9A 415	1	0,075
24 - 60V AC/DC	1 - 20 ²⁾	40 - 80	5	5	Y9AL 60	1	0,075
110 - 415V AC/DC	1 - 20 ²⁾	40 - 80	5	5	Y9AL 415	1	0,075

Time repeat accuracy	± 1%
Minimum interval between operations	2s
Short circuit protection	4A gl (gG)

Power consumption at	24V	0,2VA
	60V	5VA
220-240V	2VA	
380-415V	7VA	

1) not suitable for contactors K3-450 - K3-1200
2) - 10% / + 30%

Mounting Bar

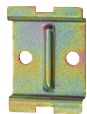

Specification	Type	Pack pcs.	Weight kg/pc.
For screw mounting of electronic timer Y9..	LG7735	10	0,09

Star-Delta Starters in Special Versions

Starters for Longer Starting Time

For longer starting times the thermal overload relay is mounted on delta-contactor. The motor is not protected in Y-connection. The timer used for this starter-type is the type Y91A, time range is 10 to 60s. Principal wiring diagram see page 104.

Ordering Example: K3YL52 230

Starters with two Thermal Overload Relays on request

Basic circuit diagram see page 104

Reversing Contactors with Mechanical Interlock

AC Operated

Ratings		Rated Current	Vorbereitet für Einbau	Wired to accept Overload Relay page 120 Type	Type	Coil voltage ¹⁾	Pack pcs.	Weight kg/pc.
AC3						110V 50Hz		
380V						220-240V 50Hz		
400V		660V	AC3			380-415 50Hz		
415V	500V	690V	400V					
kW	kW	kW	A					

Open Type

4	5,5	5,5	10	U3/32 U12/16E K3	K3NWU10 ...	1	0,6
7,5	10	7,5	18		K3NWU18 ...	1	0,6
11	15	15	24	U3/42	K3WU24 ...	1	1,2
15	18,5	18,5	32		K3WU32 ...	1	1,4
18,5	18,5	18,5	40		K3WU40	1	1,4
22	30	30	50	U3/74	K3WU50 ...	1	2,5
30	37	37	62		K3WU62 ...	1	2,5
37	45	45	74		K3WU74 ...	1	2,5



Sheet Steel Enclosed, protected to IP54

4	5,5	5,5	10	U3/32	K3NWU10B ...	1	3,9
7,5	10	7,5	18		K3NWU18B ...	1	4,1
11	15	15	24	U3/42	K3WU24B ...	1	4,5
15	18,5	18,5	32		K3WU32B ...	1	4,7
22	30	30	50	U3/74	K3WU50B ...	1	7,1
30	37	37	62		K3WU62B ...	1	7,1



Reversing Starter Connector



For Reversing Starter Types

	Type	Pack pcs.	Weight kg/pc.
K3NWU10, K3NWU18	K3NW-VB10	1	0,02
K3WU24, K3WU32	K3W-VB24	1	0,025

1) Other coil voltages see page 57

Components for Combinations		Mechanical Interlock	Reversing Starter Connector	Auxiliary Contacts Built-in for use on Contactor		Free Space for Aux. Contact Blocks on Contactor	
Left Hand Side Contactor	Right Hand Side Contactor			K1 NO/NC	K2 NO/NC	K1 HN.. or HA..	K2
K1 Type	K2 Type	Type	Type				
K3-10ND10 + HN01	K3-10ND10 + HN01	LG10889	K3NW-VB10	-	-	3	3
K3-18ND10 + HN01	K3-18ND10 + HN01	LG10889	K3NW-VB10	-	-	3	3
K3-24A00 + HN10 + HN01	K3-24A00 + HN10 + HN01	LG10889	K3W-VB24	-	-	2	2
K3-32A00 + HN10 + HN01	K3-32A00 + HN10 + HN01	LG10889	K3W-VB24	-	-	2	2
K3-40A00 + HN10 + HN01	K3-40A00 + HN10 + HN01	LG10889	K3W-VB24	-	-	2	2
K3-50A00 + HN10 + HN01	K3-50A00 + HN10 + HN01	LG10890	-	-	-	2	2
K3-62A00 + HN10 + HN01	K3-62A00 + HN10 + HN01	LG10890	-	-	-	2	2
K3-74A00 + HN10 + HN01	K3-74A00 + HN10 + HN01	LG10890	-	-	-	2	2
K3-10ND10 + HN01	K3-10ND10 + HN01	LG10889	K3NW-VB10	-	-	3	3
K3-18ND10 + HN01	K3-18ND10 + HN01	LG10889	K3NW-VB10	-	-	3	3
K3-24A00 + HN10 + HN01	K3-24A00 + HN10 + HN01	LG10889	K3W-VB24	-	-	2	2
K3-32A00 + HN10 + HN01	K3-32A00 + HN10 + HN01	LG10889	K3W-VB24	-	-	2	2
K3-50A00 + HN10 + HN01	K3-50A00 + HN10 + HN01	LG10890	-	-	-	2	2
K3-62A00 + HN10 + HN01	K3-62A00 + HN10 + HN01	LG10890	-	-	-	2	2

Contactors, Motor-Starter

Circuit Breakers

Manual Motor-Starters

Switches

AC-Main Switches

DC-Switch Disconnect

Push Buttons

Representatives, Suppliers

Pole Changing Starters

AC Operated

Ratings		Rated Current		Wired to accept Overload Relay page 120 Type	Type	Coil voltage ¹⁾ 220-240V 50Hz 380-415 50Hz	Pack pcs.	Weight kg/pc.
AC3	380V	660V	AC3					
400V			400V		230 400 ↓			
415V	500V	690V	400V					
kW	kW	kW	A					

Open Type



Rated Current (A)	Rated Power (kW)	Rated Power (kW)	Rated Current (A)	Wired to accept Overload Relay	Type	Pack pcs.	Weight kg/pc.
7,5	10	10	18	2 x U3/32 2 x U12/16E K3	K3NPU18 ...	1	1,0
11	15	15	24		K3NPU24 ...	1	1,5
15	18,5	18,5	32	2 x U3/32	K3PU32 ...	1	1,9
22	30	30	50	2 x U3/74	K3PU50 ...	1	3,9
30	37	37	62		K3PU62 ...	1	3,9

Sheet Steel Enclosed, protected to IP54



Rated Current (A)	Rated Power (kW)	Rated Power (kW)	Rated Current (A)	Wired to accept Overload Relay	Type	Pack pcs.	Weight kg/pc.
7,5	10	7,5	18	2x U3/32	K3NPU18B ...	1	1,0
11	15	15	24		K3NPU24B ...	1	1,5
15	18,5	18,5	32		K3PU32B ...	1	1,9

Ordering Example: Pole Changing Starter, open version, rated AC3 at 400V 28A and 15A, control voltage 230V 50Hz
Order Type: K3PU32 230 + U3/32 32 + U3/32 18

Pole Changing Starters for Star-Delta Operation on request

1) Other coil voltages see page 57

Components for Combinations			Free Space for		
High Speed	Low Speed	Star Contactor	Aux. Contact Blocks on High Speed	Low Speed	Star
K1 Type	K2 Type	K3 Type	K1 HN.. or HA..	K2	K3
K3-18ND01 + 2 x HN10	K3-18ND01 + HN10	K3-14ND10	2	3	4
K3-24A00 + HN01 + 2 x HN10	K3-24A00 + HN01 + HN10	K3-18ND10	1	2	4
K3-32A00 + HN01 + 2 x HN10	K3-32A00 + HN01 + HN10	K3-24A00 + HN10	1	2	3
K3-50A00 + HN01 + 2 x HN10	K3-50A00 + HN01 + HN10	K3-32A00 + HN10	1	2	3
K3-62A00 + HN01 + 2 x HN10	K3-62A00 + HN01 + HN10	K3-50A00 + HN10	1	2	3
K3-18ND01 + 2 x HN10	K3-18ND01 + HN10	K3-14ND10	2	3	4
K3-24A00 + HN01 + 2 x HN10	K3-24A00 + HN01 + HN10	K3-18ND10	1	2	4
K3-32A00 + HN01 + 2 x HN10	K3-32A00 + HN01 + HN10	K3-24A00 + HN10	1	2	3

Star-Delta Starters

Data according to IEC 947-4-1, VDE 0660, EN 60947-4-1

Type		K3NY15	K3NY26	K3Y40	K3Y52	K3Y80	K3Y100	K3Y140	K3Y200	K3Y240	K3Y300	
Main Contacts												
Rated insulation voltage $U_i^{1)}$	V AC	690	690	690	690	690	690	690	690	690	690	
Frequency of operations z AC3, I_e	1/h	15										
Change-over time max. (Y-step)	s	20 (Type K3YL ... 60)										
Utilization category AC3												
Switching of three-phase motors												
Rated operational current I_e	220-230V	A	16	30	45	60	85	109	150	205	240	300
	240V	A	16	30	45	60	85	109	150	205	240	300
	380-400V	A	16	30	45	60	85	109	150	205	240	300
Rated operational power of three-phase motors 50-60Hz	415-440V	A	15	30	45	60	85	109	150	205	240	300
	500V	A	15	30	45	60	85	95	150	205	190	240
	660-690V	A	13	17	30	36	57	72	103	118	147	180
Rated operational power of three-phase motors 50-60Hz	220-230V	kW	4	7,5	11	15	22	30	45	55	75	90
	240V	kW	5,5	11	15	18,5	22	30	45	55	75	90
	380-400V	kW	7,5	15	22	30	45	55	75	110	132	160
Rated operational power of three-phase motors 50-60Hz	415-440V	kW	7,5	15	22	30	45	55	75	110	140	170
	500V	kW	7,5	18,5	30	37	55	75	90	132	132	180
	660-690V	kW	11	15	22	30	45	55	90	110	132	180
Cable cross-sections												
Line	solid or stranded	mm ²	1,5 - 6 ²⁾		1,5 - 16		10 - 70 ³⁾		10 - 120		busbar	
	flexible	mm ²	1,5 - 4 ²⁾		1,5 - 16		16 - 50 ³⁾		10 - 95		18x5	
	flexible with multicore cable end	mm ²	1,5 - 4 ²⁾		1,5 - 16		10 - 35		10 - 95		M8	
Motor	solid or stranded	mm ²	1,5 - 6		1,5 - 16		4 - 35 ³⁾		10 - 120		busbar	
	flexible	mm ²	1,5 - 4		1,5 - 16		6 - 25 ³⁾		10 - 95		18x5	
	flexible with multicore cable end	mm ²	1,5 - 4		1,5 - 16		4 - 25		10 - 95		M8	
Power consumption of the combination												
inrush and change-over	VA		55		130		183		560		700	
	sealed VA		20		26		36		10		10	
	W		6		8		14		10		10	

Coil Voltage Ranges and Non Standard Voltages for Star-Delta Starters

K3NY15.. to K3Y100..

Suffix to Star-Delta Starter type e.g. K3Y80 400	Rated Control Voltage U_s			
	range for 50Hz		range for 60Hz	
	min. V	max. V	min. V	max. V
24	24	24	24	27
42	42	47	47	52
110	100	110	110	122
180	180	210	200	240
230	220	240	230	264
400	380	415	400	415

K3Y140, to K3Y300..

Suffix to Star-Delta Starter type e.g. K3Y300 230	Rated Control Voltage U_s				
	range for 50Hz		range for 60Hz		for DC
	min. V	max. V	min. V	max. V	V
24	24	24	24	24	24
48	48	48	48	48	48
110	110	120	110	120	110
230	220	240	220	240	220
400	380	415	380	415	-

Standard voltages in bold type letters

1) Suitable for: earthed-neutral systems, overvoltage category I to IV, pollution degree 3 (standard-industry): $U_{imp} = 8kV$.
Data for other conditions on request.

2) Additional terminals see page 95

3) Maximum cable cross-section with prepared conductor

Reversing Starters

Data according to IEC 947-4-1, VDE 0660, EN 60947-4-1

Type		K3NWU10	K3NWU18	K3WU24	K3WU32	K3WU50	K3WU62	K3WU74
Main Contacts								
Rated insulation voltage $U_i^{(1)}$	V AC	690	690	690	690	690	690	690
Utilization category AC3								
Switching of three-phase motors								
Rated operational current I_e	220V A	12	18	23	30	45	63	
	230V A	11,5	18	24	32	50	62	74
	240V A	11	18	24	32	50	62	74
	380-400V A	10	18	24	32	50	62	74
	415-440V A	9	18	23	30	50	62	74
	500V A	9	16	23	30	45	60	74
	660-690V A	6,5	8,5	17	20	31	40	40
Rated operational power of three-phase motors 50-60Hz	220-230V kW	3	5	6	8,5	12,5	18,5	
	240V kW	3	5	7	9	13,5	19	23
	380-400V kW	4	7,5	11	15	22	30	37
	415-440V kW	4,5	8,5	12	16	24	33	40
	500V kW	5,5	10	15	18,5	30	37	45
	660-690V kW	5,5	10	15	18,5	30	37	45
Cable cross-sections								
Line	solid or stranded	mm ²	0,75 - 6		1,5 - 25		4 - 50	
	flexible	mm ²	1 - 4		2,5 - 16		6 - 35	
	flexible with multicore cable end	mm ²	0,75 - 4		1,5 - 16		6 - 35	
Cables per clamp			1		1		1	
Power consumption of the combination								
inrush and change-over sealed	VA	33 - 45		90 - 115		140 - 185		
	VA	7 - 10		9 - 13		13 - 18		
	W	2,6 - 3		2,7 - 4		5,4 - 7		

Technical Data according to UL508

Main Contacts (cULus)	Type	KNW3-10	KNW3-18	KW3-24	KW3-32	KW3-40
Rated operational power of three-phase motors at 60Hz (3ph)	110-120V hp	1½	2	5	5	7½
	200V hp	3	5	7½	10	10
	220-240V hp	3	7½	10	10	15
	277V hp	3	7½	7½	10	15
	380-415V hp	5	10	10	15	20
	440-480V hp	5	10	15	20	25
	550-600V hp	7½	15	20	25	30
Fuse / Short-circuit current	A/kA	30/5	50/5	90/5	125/5	175/5
Rated voltage	V	600	600	600	600	600
Auxiliary Contacts (cULus)		A600	A600	A600	A600	A600
Cable cross-sections						
for main connectors	solid	AWG	18 - 10		16 - 10	
	flexible	AWG	18 - 10		14 - 4	
Cables per clamp			1		1	

1) Suitable for: earthed-neutral systems, overvoltage category I to IV, pollution degree 3 (standard-industry): $U_{mp} = 8kV$. Data for other conditions on request.

Pole Changing Starters

Data according to IEC 947-4-1, VDE 0660, EN 60947-4-1

Type		K3NPU18	K3NPU24	K3PU32	K3PU50	K3PU62
Main Contacts						
Rated insulation voltage U_i ¹⁾	V AC	690	690	690	690	690
Utilization category AC3						
Switching of three-phase motors						
Rated operational current I_e	220V A	18	23	30	45	63
	230V A	17,5	23	30	45	60
	240V A	17	23	30	45	60
	380-400V A	16	23	30	45	60
	415V A	16	23	30	45	60
	440V A	16	23	30	45	60
	500V A	16	23	30	45	55
	660V A	9	17,5	21	33	42
	690V A	8,5	17	20	31	40
Rated operational power of three-phase motors 50-60Hz	220-230V kW	5	6	8,5	12,5	18,5
	240V kW	5	7	9	13,5	19
	380-400V kW	7,5	11	15	22	30
	415-440V kW	8,5	12	16	24	33
	500V kW	10	15	18,5	30	37
	660-690V kW	7,5	15	18,5	30	37
Cable cross-sections						
Line	solid or stranded mm ²	0,75 - 6	1,5 - 25		4 - 50	
	flexible mm ²	1 - 4	2,5 - 16		6 - 35	
	flexible with multicore cable end mm ²	0,75 - 4	1,5 - 16		6 - 35	
Cables per clamp		1	1		1	
Power consumption of the combination						
	inrush and change-over VA	55	128		178	
	sealed VA	20	26		31	
	W	6	8		11	

1) Suitable for: earthed-neutral systems, overvoltage category I to IV, pollution degree 3 (standard-industry): $U_{imp} = 8kV$. Data for other conditions on request.

Star-Delta Starters

Wiring Diagrams Main Circuit

Terminal markings of contactors and relays according to DIN EN 50012
Connections shown in main and circuits as broken lines are not included.

K3NY15 to K3Y100

with thermal overload relay U3/.. or U12/16

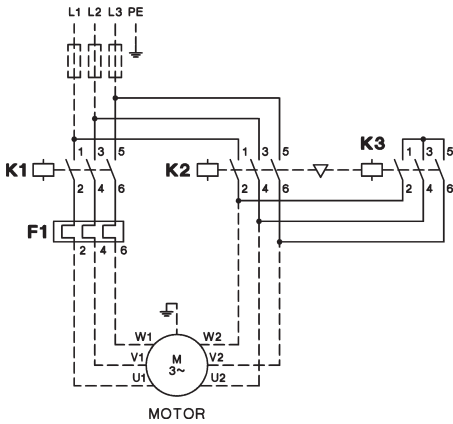

K3Y140 to K3Y300

with thermal overload relay U85 or U180

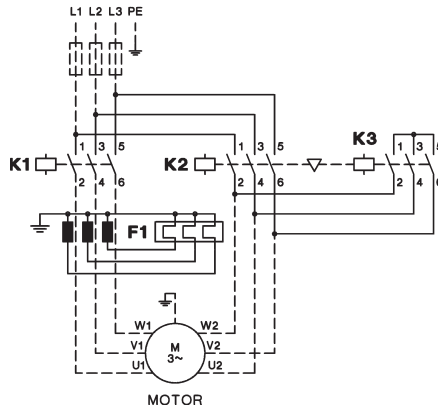

Wiring Diagrams Control Circuit

K3NY15 to K3Y52

operating with control switch

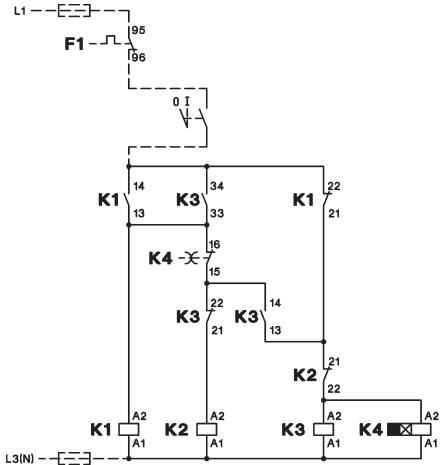

K3NY15 to K3Y52

operating with push buttons

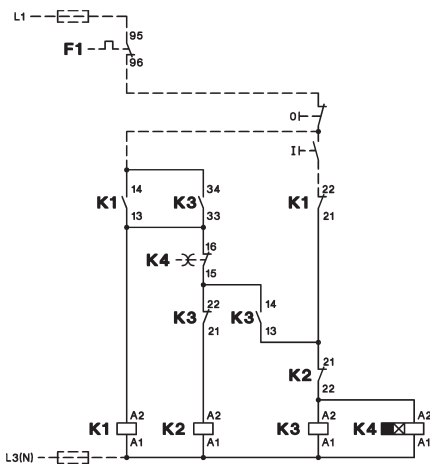

K3Y80 to K3Y200

operating with control switch

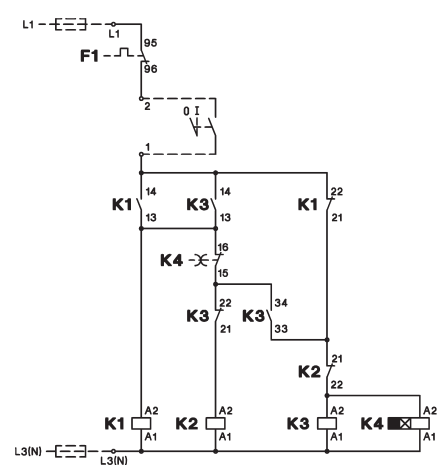

K3Y80 to K3Y200

operating with push buttons

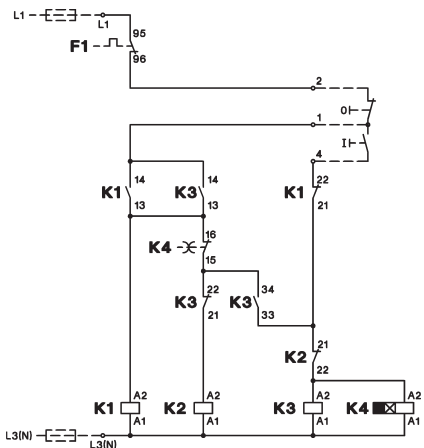

K3Y240 to K3Y300

operating with control switch

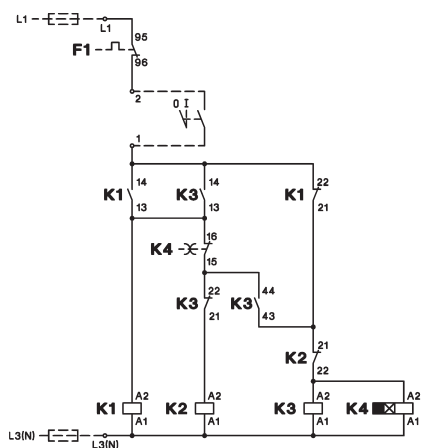

K3Y240 to K3Y300

operating with push buttons

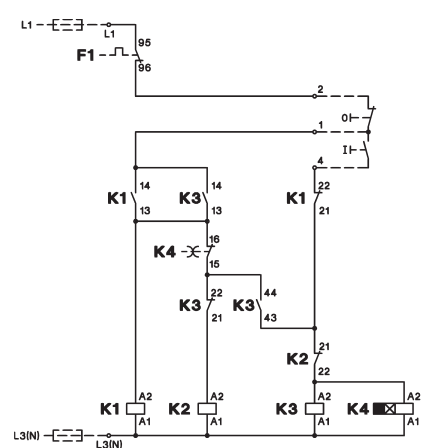

Star-Delta Starters

Wiring Diagrams Main Circuit

Terminal markings of contactors and relays according to DIN EN 50012
 Connections shown in main and control circuits as broken lines are not included.

K3YL..

Typical circuit diagram

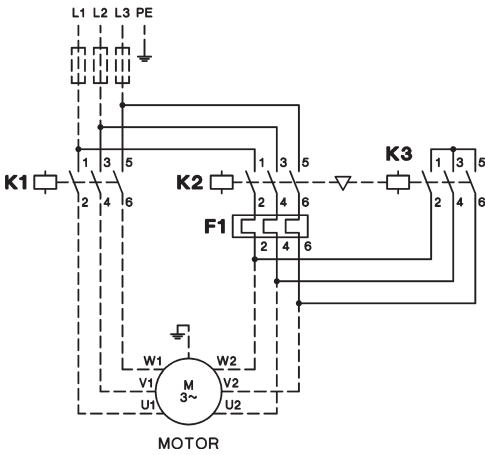

K3Y.. with 2 Thermal Overload Relays

Typical circuit diagram

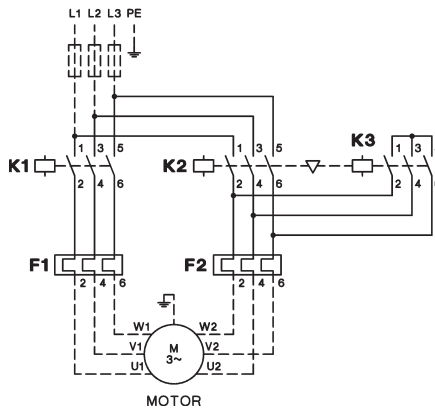

Wiring Diagrams Control Circuit

with selector switch

K3Y..W

Typical circuit diagram
 operating with control switch

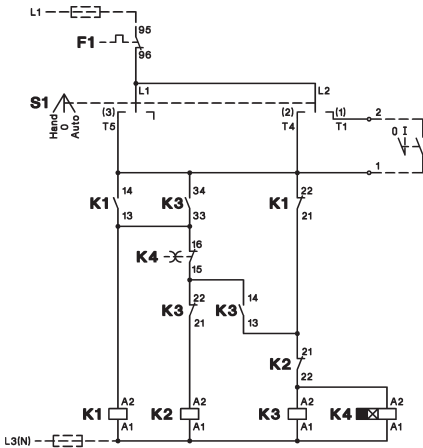

Typical circuit diagram
 operating with push buttons

with push buttons

K3Y..T

Typical circuit diagram

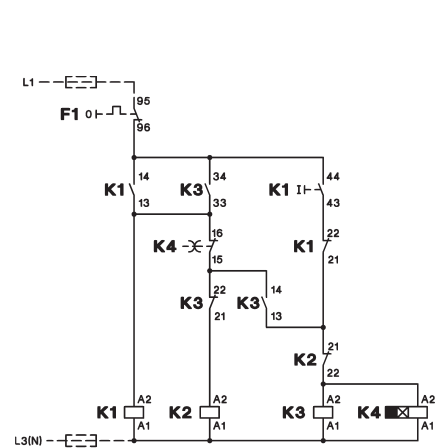
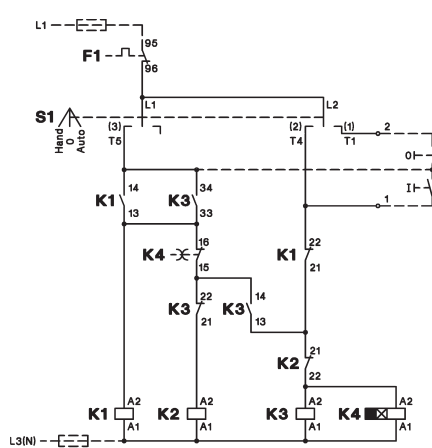

Reversing Contactors

Wiring Diagrams Main Circuit

Terminal markings of contactors and relays according to DIN EN 50012
 Connections shown in main and control circuits as broken lines are not included.

K3NWU10 to K3WU74

with thermal overload relay U3/32, U3/42 or U3/74

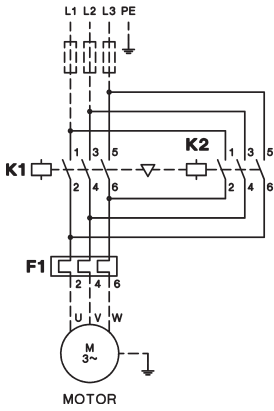

Wiring Diagrams Control Circuit

K3NWU10 to K3WU32

operating with control switch

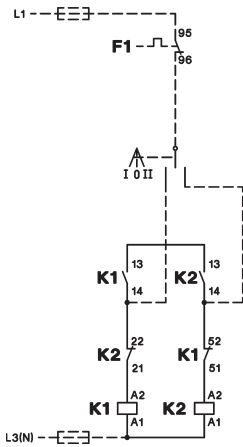

operating with push buttons
Reversing over off-position

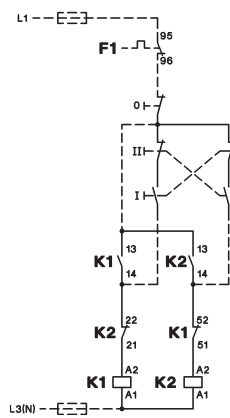

Reversing direct

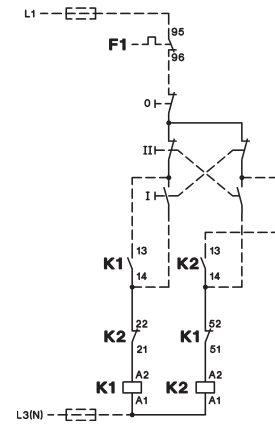

K3WU50, K3WU62, K3WU74

operating with control switch

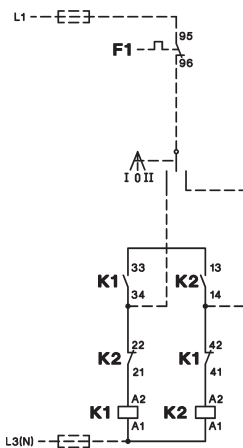

operating with push buttons

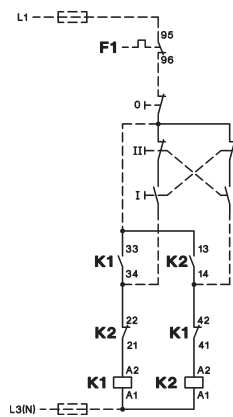

Pole Changing Starters

Wiring Diagrams

Terminal markings of contactors and relays according to DIN EN 50012
 Connections shown in main and control circuits as broken lines are not included.

Main Circuit

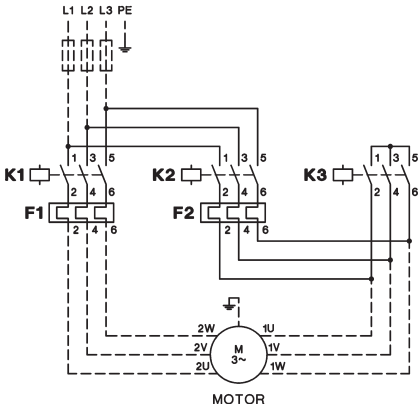

Principal Control Circuit Wiring Diagram

operating with control switch

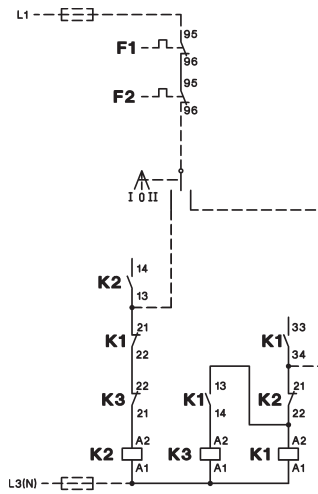

operating with push buttons

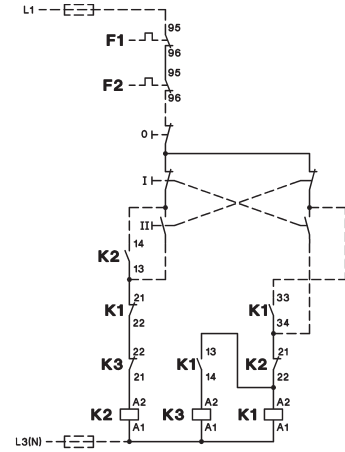

	Low speed	High speed	Low speed	High speed
Operation	Delta	Double-Star	Star	Double-Star
Speed relation	1	2	1	2
Power relation	1	1,5 - 1,8	0,3	1

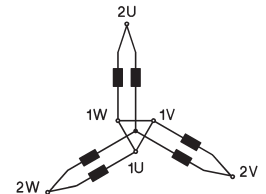
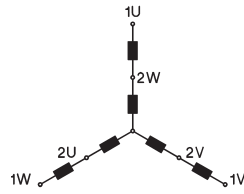
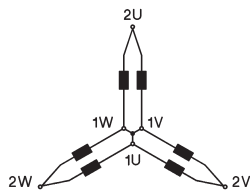
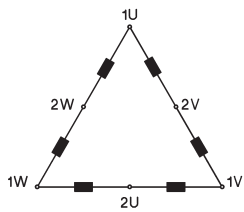

Star-Delta Starters

Dimensions

Star-Delta Starters, AC operated, open type

K3NY15 + U3/32
K3NY26

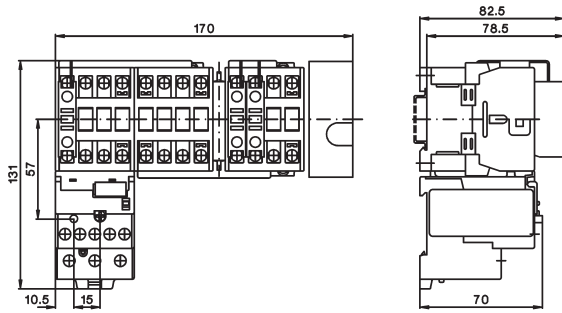

K3NY15 + U12/16E G3
K3NY26

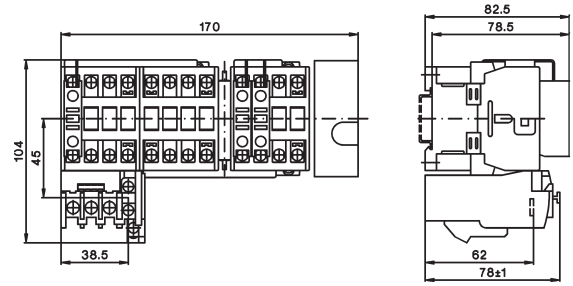

K3Y40 + U3/32
K3Y52 + U3/32

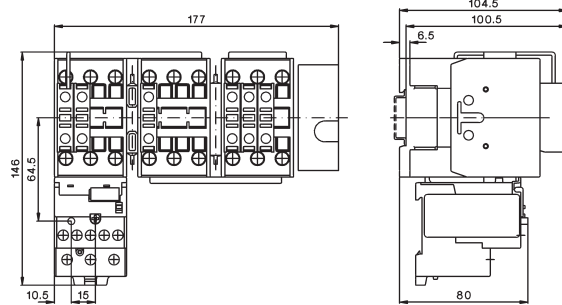

K3Y40 + U3/42
K3Y52 + U3/42

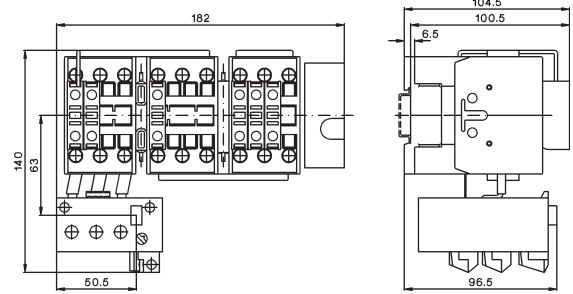

K3Y80 + U3/74

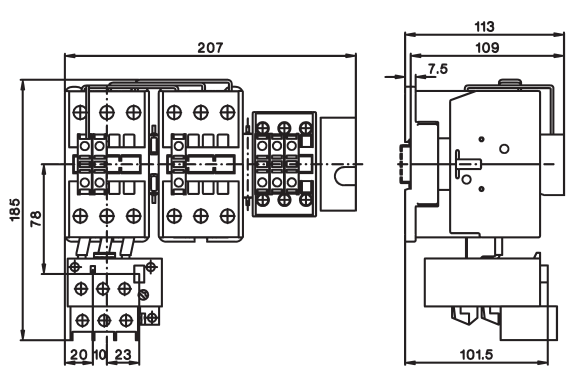

K3Y100 + U3/74

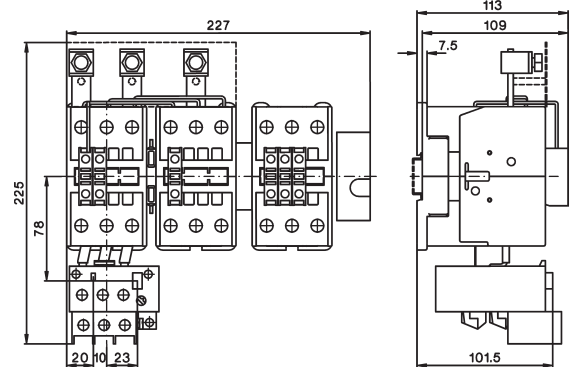

K3Y140 + U85
K3Y200

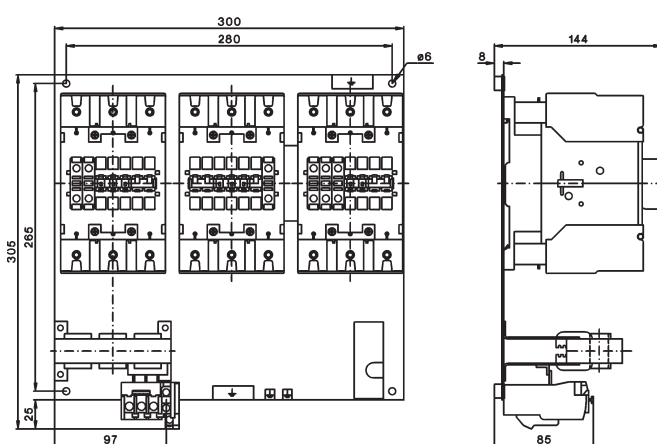

K3Y240 + U180 + SU180/176
K3Y300

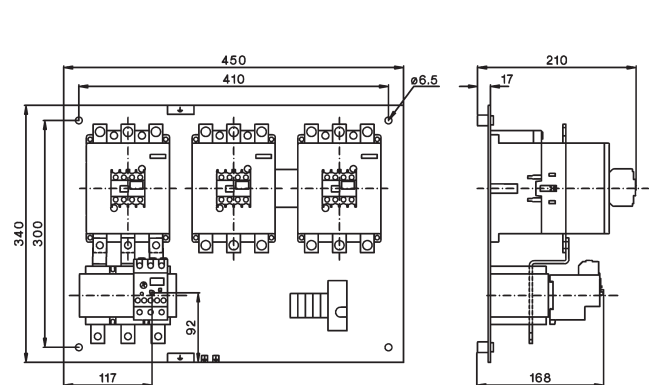

Star-Delta Starters

Dimensions

Star-Delta Starters, plastic enclosed, protected to IP65

K3NY26P

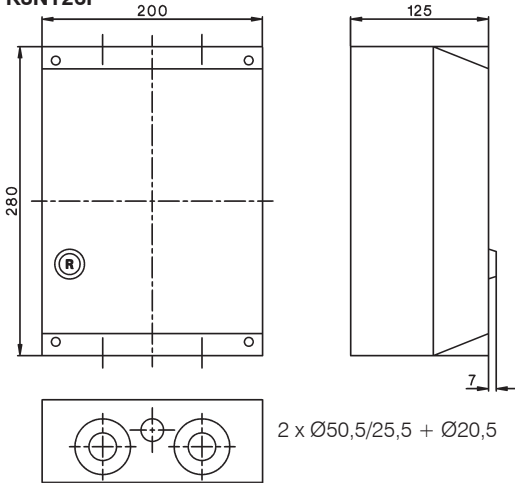

K3Y40P to K2Y100P

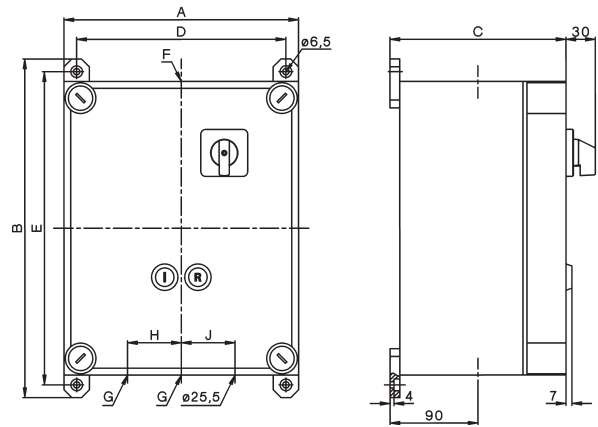

Type	A	B	C	D	E	Ø F	Ø G	H	J	
K3Y40P	300	346	180	272	320	6,5	32,5	32,5	60	60
K3Y52P	300	346	180	272	320	6,5	32,5	32,5	60	60
K3Y80P	300	446	180	272	420	6,5	40,5	40,5	70	70
K3Y100P	300	446	180	272	420	6,5	50,5	40,5	70	70

Star-Delta Starters, sheet steel enclosed, protected to IP54

K3Y26B to K3Y52B

Type	Ø F	Ø G
K3NY26B	25,5	25,5
K3Y40B	32,5	32,5
K3Y52B	32,5	32,5

Mounting by included fixing link

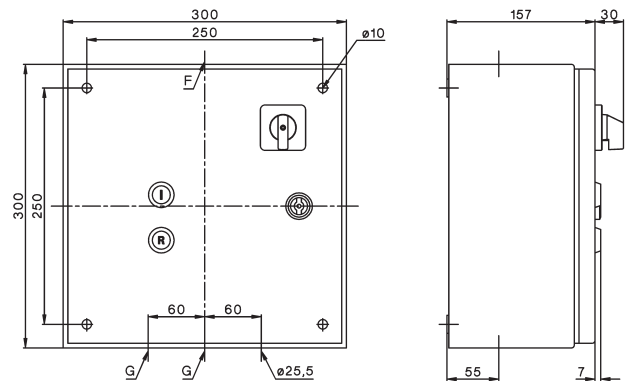
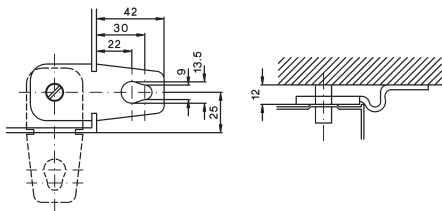

K3Y80B to K2Y200B

Type	A	B	C	D	E	L	M
K3Y80B	380	380	210	340	340	8,7	65
K3Y100B	380	380	210	340	340	8,7	65
K3Y140B	380	600	210	560	340	8,7	65
K3Y200B	380	600	210	560	340	8,7	65

Type	Ø F	Ø G	H	J	K
K3Y80B	40,5	40,5	70	70	60
K3Y100B	50,5	40,5	80	70	60
K3Y140B	50,5	50,5	80	80	70
K3Y200B	50,5	50,5	80	80	70

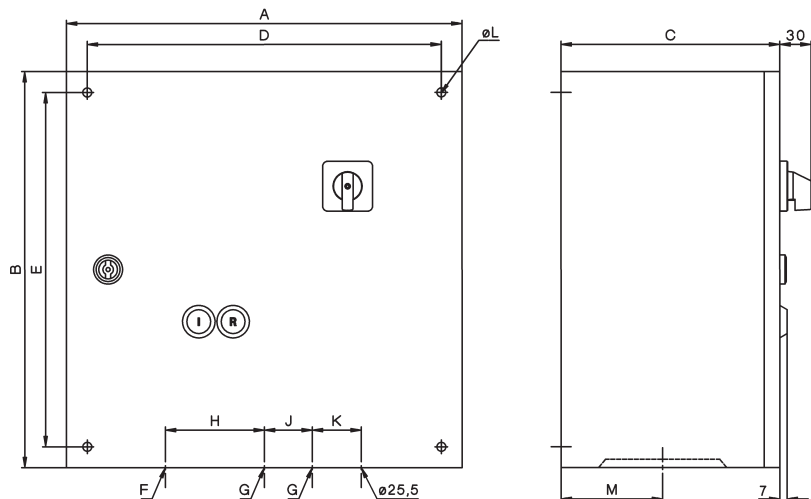

Reversing Contactors

Dimensions

Reversing Starters, AC operated, open type

K3NWU10 + U3/32
K3NWU18

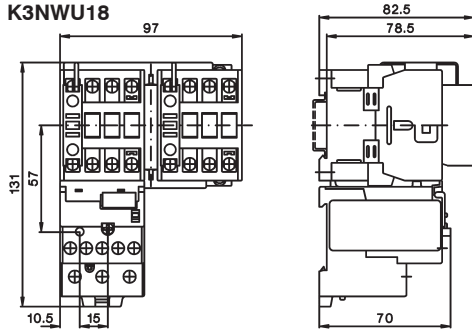

K3NWU10 + U12/16E G3
K3NWU18

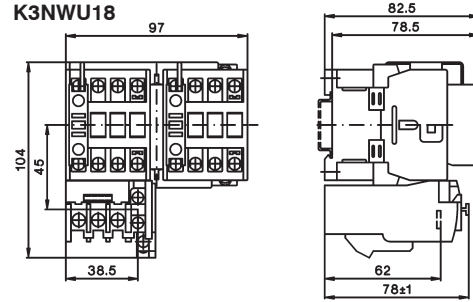

K3WU24 + U3/32
K3WU32
K3WU40

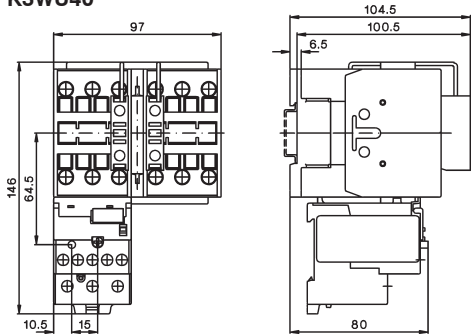

K3WU24 + U3/42
K3WU32
K3WU40

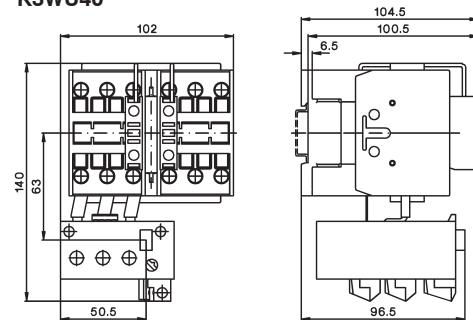

K3WU50 + U3/74
K3WU62
K3WU74

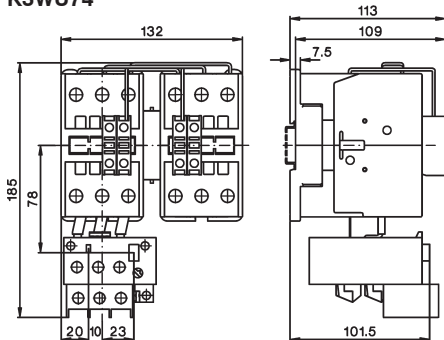

Reversing Contactors, sheet steel enclosed, protected to IP54

Type	A	B	C	D	E	F	G	H	K
K3NWU18B	300	300	150	250	250	30	30	Ø25,5	41
K3WU24B	300	300	150	250	250	30	30	Ø32,5	41
K3WU32B	300	300	150	250	250	30	30	Ø32,5	41
K3WU50B	300	300	150	250	250	40	40	Ø32,5	59
K3WU62B	300	300	150	250	250	40	40	Ø32,5	59

Mounting by included fixing link

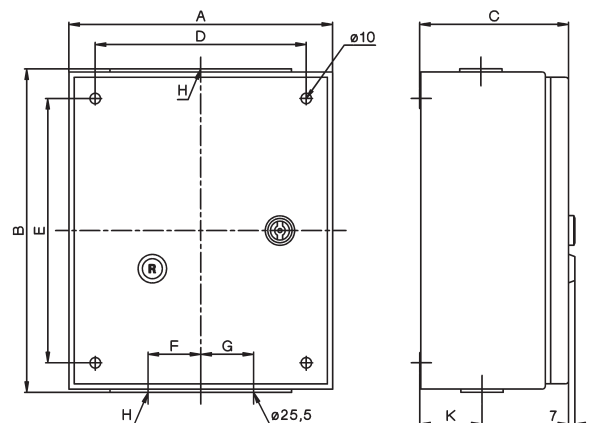
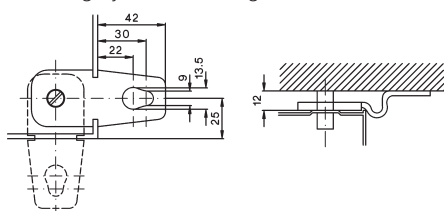

Pole Changing Starters

Dimensions

Pole Changing Starters, AC operated, open type

K3NPU18 + 2x U3/32

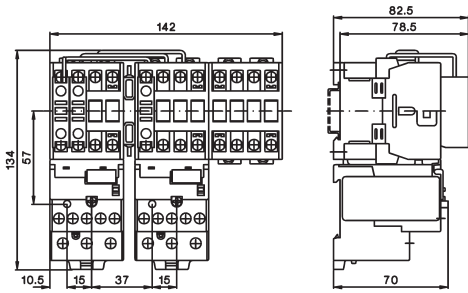

K3NPU18 + 2x U12/16

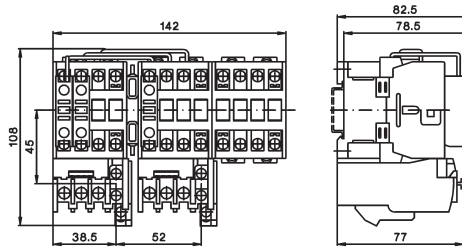

**K3PU24 + 2x U3/32
K3PU32**

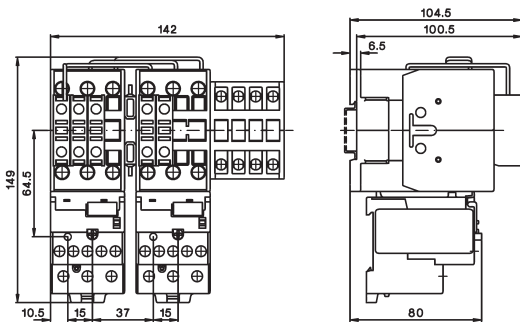

**K3PU50 + 2x U3/74
K3PU62**

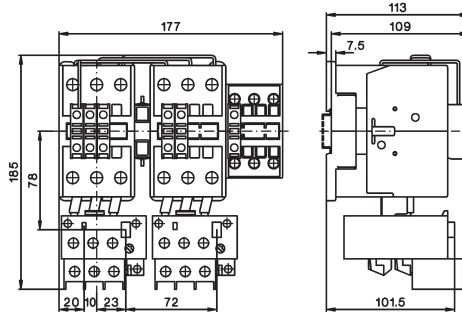

Pole Changing Starters, sheet steel enclosed, protected to IP54

K3NPU18B to K3PU32B

Type	Ø F	Ø G
K3NPU18B	25,5	25,5
K3PU24B	32,3	32,5
K3PU32B	32,3	32,5

Mounting by included fixing link

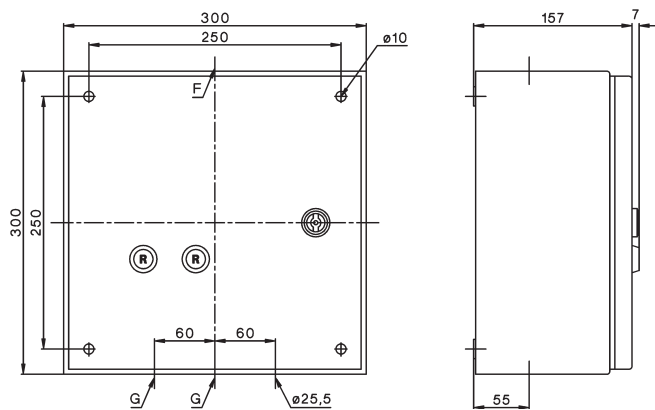
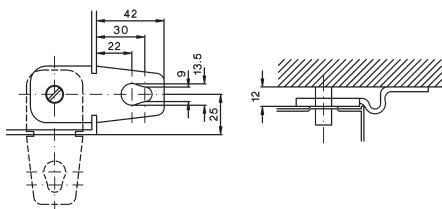



D.O.L. Starters With Start-Stop Buttons

112



D.O.L. Starters With Selector Switch

112



D.O.L. Starters With Selector Switch And Pneumatic Switch For Use In Moist Rooms

112



Enclosures

113



Accessories

113

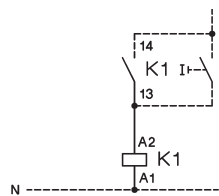

Wiring Diagrams

115

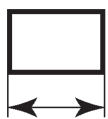

Dimensions

116

D.O.L. Starters In Plastic Enclosure

Ratings	Included	Free	order	Protec-	Conduit	Type	Coil voltage ¹⁾	Pack	Weight
AC3 at	Contact	Space	extra	tion	Entries			pcs.	kg/pc.
380V		f. Aux.		Degree			230 220-240V 50Hz		
400V		Cont.	Overload				400 380-415V 50Hz		
415V		HN..	Relay						
kW	Type	pcs.	Type						

D.O.L. Starters with Start-Stop/Reset Push Buttons



4	K3-10ND10	2	U12/16 K3	IP65	Ø 20,5mm	P1T10 ...	1	0,6
7,5	K3-18ND10	2	U12/16 K3	IP65	Ø 20,5mm	P1T18 ...	1	0,6
11	K3-22ND10	2	U12/16 K3	IP65	Ø 20,5mm	P1T22 ...	1	0,6

D.O.L. Starters with Selector Switch



4	K3-10ND10	2	U12/16 K3	IP65	Ø 20,5mm	P1W10 ...	1	0,6
7,5	K3-18ND10	2	U12/16 K3	IP65	Ø 20,5mm	P1W18 ...	1	0,6
11	K3-22ND10	2	U12/16 K3	IP65	Ø 20,5mm	P1W22 ...	1	0,6

D.O.L. Starters with Selector Switch and Pneumatic Switch for moist rooms



7,5	K3-18ND10	2	U12/16 K3	IP65	Ø 20,5mm	P1W18P ...	1	0,6
------------	-----------	---	-----------	------	----------	-------------------	---	-----

Push button and tube on request

Ordering Example: D.O.L. Starter with selector switch, plastic enclosed, rated AC3 at 400V 15,5A, rated control voltage 230V 50Hz - **Order Type: P1W18 230 + U12/16E 18 K3**

Pneumatic Button



						P1LT	1	
--	--	--	--	--	--	-------------	---	--

Air Pressure Hose



Length 5m						P1LS-5	1	
-----------	--	--	--	--	--	---------------	---	--

Pneumatic Switch



for refill of D.O.L. Starter P1W.. to P1W..P						P1-LDR	1	0,02
--	--	--	--	--	--	---------------	---	------

Thermal Overload Relays



Setting range A	Type	Pack pcs.	Weight kg/pc.
0,12 - 0,18	U12/16E 0,18 K3	1	0,10
0,18 - 0,27	U12/16E 0,27 K3	1	0,10
0,27 - 0,4	U12/16E 0,4 K3	1	0,10
0,4 - 0,6	U12/16E 0,6 K3	1	0,10
0,6 - 0,9	U12/16E 0,9 K3	1	0,10
0,8 - 1,2	U12/16E 1,2 K3	1	0,10
1,2 - 1,8	U12/16E 1,8 K3	1	0,10
1,8 - 2,7	U12/16E 2,7 K3	1	0,10
2,7 - 4	U12/16E 4 K3	1	0,10
4 - 6	U12/16E 6 K3	1	0,10
6 - 9	U12/16E 9 K3	1	0,10
8 - 11	U12/16E 11 K3	1	0,10
10 - 14	U12/16E 14 K3	1	0,10
13 - 18	U12/16E 18 K3	1	0,10
17 - 23	U12/16E 23 K3	1	0,10
22 - 30	U12/16E 30 K3	1	0,13

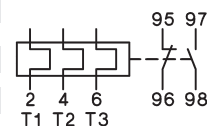

manual reset

Overload Relays with Quick Tripping Characteristic see page 120,121

Technical data see contactors page 62 and thermal overload relays page 125
1) Non-standard coil voltages see page 57

Enclosures for Contactors



Suitable for contactor	Protection Degree	Conduit Entries Top	Conduit Entries Bottom	Type	Pack pcs.	Weight kg/pc.
K3-07.. to K3-22.. K3-24..¹⁾ to K3-40..¹⁾	IP65	2 x Ø 20,5mm	2 x Ø 20,5mm	P1	1	0,35

with Reset Button



Suitable for contactor	Protection Degree	Conduit Entries Top	Conduit Entries Bottom	Type	Pack pcs.	Weight kg/pc.
K3-10.. to K3-22.. +U12/16.. K3	IP65	2 x Ø 20,5mm	2 x Ø 20,5mm	P1R	1	0,35

with Selector Switch



Suitable for contactor	Protection Degree	Conduit Entries Top	Conduit Entries Bottom	Type	Pack pcs.	Weight kg/pc.
K3-10.. to K3-22.. +U12/16.. K3	IP65	2 x Ø 20,5mm	2 x Ø 20,5mm	P1W	1	0,35

with Start-Stop Push Button



Suitable for contactor	Protection Degree	Conduit Entries Top	Conduit Entries Bottom	Type	Pack pcs.	Weight kg/pc.
K3-10.. to K3-22.. +U12/16.. K3	IP65	2 x Ø 20,5mm	2 x Ø 20,5mm	P1T	1	0,35

Indicator Units



Specifications	Voltage Range	Type	Pack pcs.	Weight kg/pc.
Coil Current Indicator , green (LED)	24 - 660V AC/DC	K2-ING	10	0,02
Coil Current Indicator , red (LED)	24 - 660V AC/DC	K2-INR	10	0,02
To be connected in series with the contactor coil. In case of coil interruption the indicator goes out. Voltage drop approx. 2 volts				
Voltage Indicator , clear (glow-disc. I.)	220 - 415V AC/DC	K2-UN	10	0,02
Voltage Indicator , red (LED)	24 - 120V AC/DC	K2-UNR	10	0,02
To be connected parallel to the contactor coil. In case of applied voltage the indicator also lights at coil interruption.				

Lens Caps For Indicator Units

Lens cap transparent	LG9743T	10	0,005
Lens cap red	LG9743R	10	0,005
Lens cap green	LG9743GR	10	0,005

Mounting instructions see page 118

Heating Element



Specifications	Voltage Range	Power Consumption	Type	Pack pcs.	Weight kg/pc.
To avoid condensed water on places where high humidity is given together with alterations of ambient temperature	380 - 415V	1,5W	K2-HR	10	0,02
	220 - 240V	1,5W	K2-HR 230	10	0,02

Additional Terminals, Start Contact



Specification	Cable Cross-sections to clamp mm ²			Type	Pack pcs.	Weight kg/pc.
	solid or stranded	flexible	flexib. w. multi-core cable end			
Neutral Terminal	2 x 0,75-4	2 x 0,75-2,5	2 x 0,5-2,5	LG9744	10	0,009
Earth Terminal	2,5-16	1,5-10	1,5-10	LG9750	10	0,052
Mounting instructions see page 116						
Start Contact	for contactor K3-10 to K3-22	to be snapped on top of the auxiliary contact		LG9319-K3	10	0,03

¹⁾ without auxiliary contact blocks

D.O.L. Starters

Wiring Diagrams Main Circuit

All fuses F0 shown in the main circuits are not included.
Terminal markings according to EN 50012

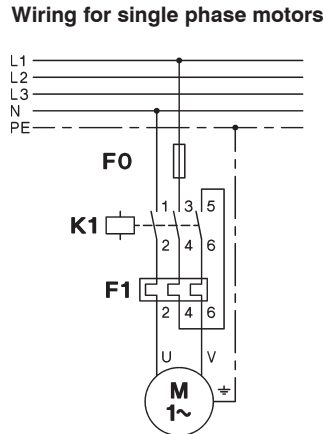
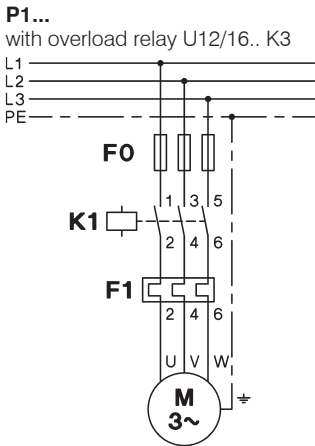

Wiring Diagrams Control Circuit

D.O.L. Starters P1 with standard coil voltages (see page 94) are supplied with connectors between main circuit and control circuit.

Coil connectors

Coils for **380-415V 50Hz** and **400-440V 60Hz**: The starter is supplied with control circuit connectors between terminals 1 (L1) and 5 (L3).
Coils for **220-240V 50Hz** and **230-264V 60Hz**: The starter is supplied with control circuit connectors between terminals 95 and 5 (L3). Connect neutral wire to terminal A1.
Coils for **other voltages**: Without connectors between supply and control circuit. Connect supply to terminals A1 and 95.

Separate coil supply

Coils for **380-415V 50Hz** and **400-440V 60Hz**: Remove connectors A1-1 and 95-5, connect supply to terminals A1 and 95.
Coils for **220-240V 50Hz** and **230-264V 60Hz**: Remove connectors 95-5 connect supply to terminals A1 and 95.
Coils for **other voltages**: Connect supply to terminals A1 and 95.

Coil phase to phase (380-415V 50Hz)

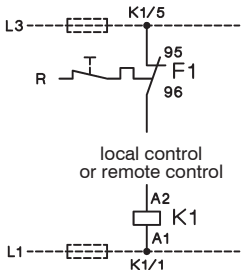

Coil phase to neutral (220-240V 50Hz)

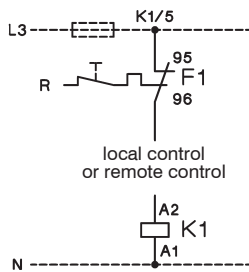

Coil phase to phase

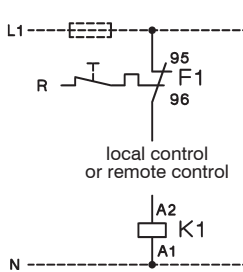

Coil phase to neutral

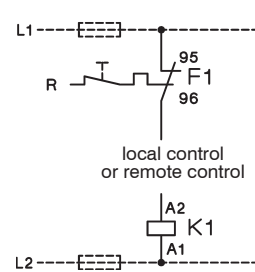

D.O.L. Starters with remote control

P1..
Remote 2-wire (switch) control

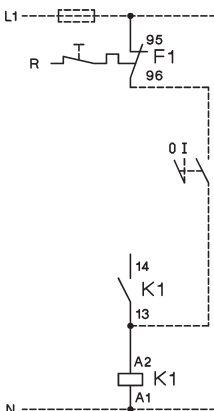

Remote 3-wire (push button) control

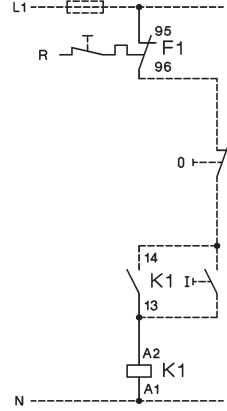

Remote start-stop control
(3 control stations)

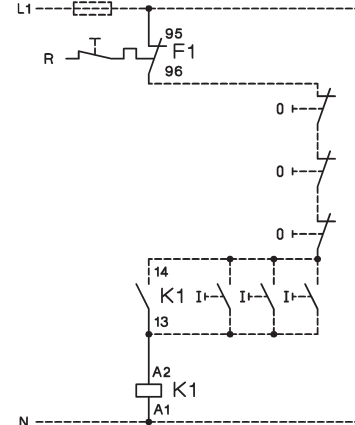

D.O.L. Starters

Wiring Diagrams Control Circuits

Typical circuit diagram (for separate coil supply, control circuit connected between L1 and N)
Terminal markings according to EN 50012

D.O.L. Starters with Start-Stop/Reset Push Buttons

P1T10, P1T18, P1T22
with overload relay U12/16.. K3

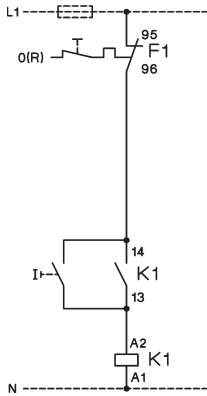

P1T10, P1T18, P1T22
with external push buttons

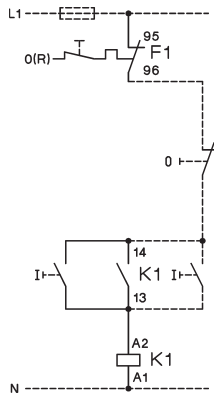

D.O.L. Starters with Selector Switch

P1W10, P1W18, P1W22
with external control switch

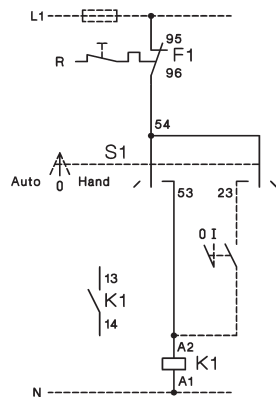

P1W10, P1W18, P1W22
with external push buttons

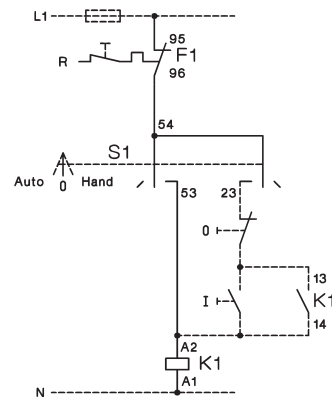

D.O.L. Starters with Selector Switch and Pneumatic Switch for Swimmingpool Control Gear and for use in Moist Rooms

P1W18P
with overload relay U12/16.. K3

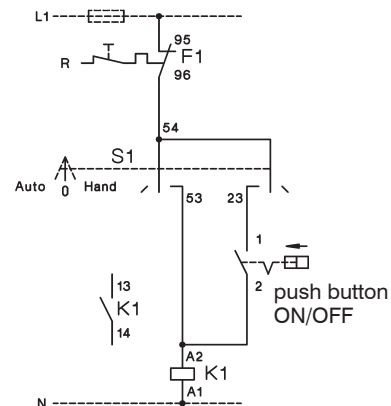

D.O.L. Starters

Dimensions

D.O.L. Starters with Start-Stop/Reset Push Buttons, Plastic Enclosed

P1T., P1TP.

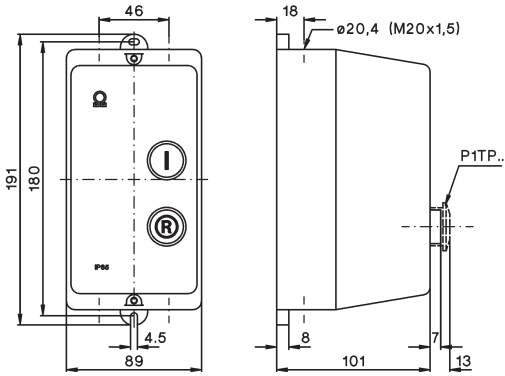

D.O.L. Starters with Selector Switch, Plastic Enclosed

P1W., P1W18P

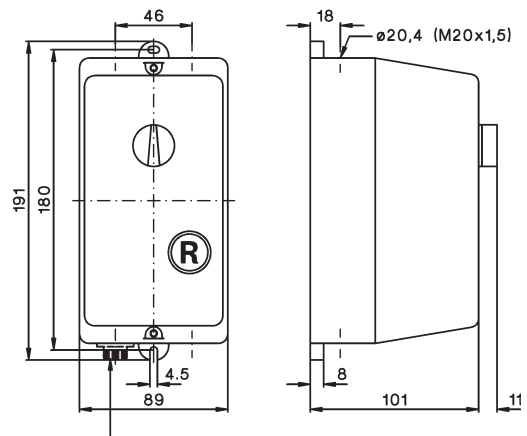

P1W18P: plug-in for air tube inside diameter 3mm

Rear Conduit Entries

knockouts
4 x Ø 23

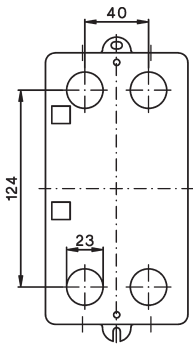

Earth Terminal LG9750 for K2-23 and K2-30 in Enclosure P1

for K2-23 and K2-30 remove spacing piece

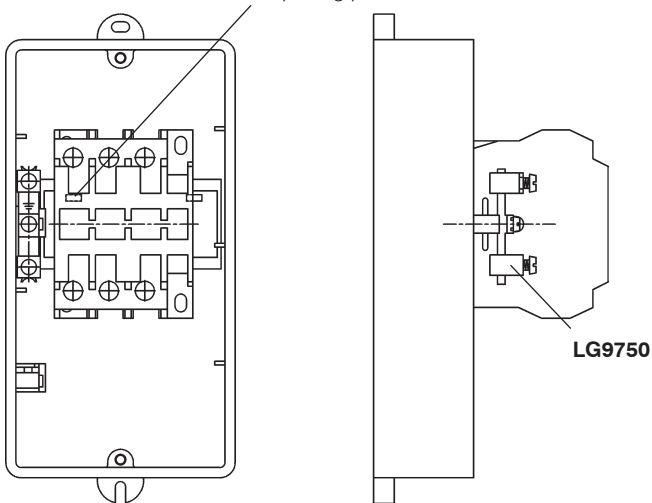

Neutral Terminal LG9744

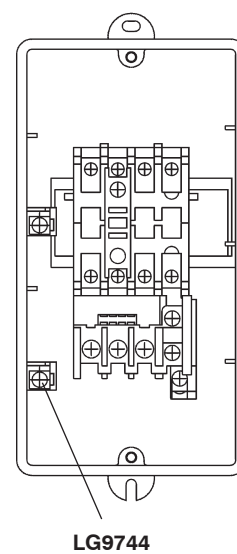

Enclosures

Dimensions

Enclosures for Contactors

P1

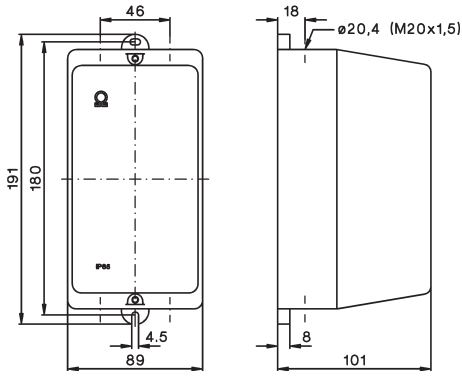

Enclosures for D.O.L. Starters

P1R, P1P

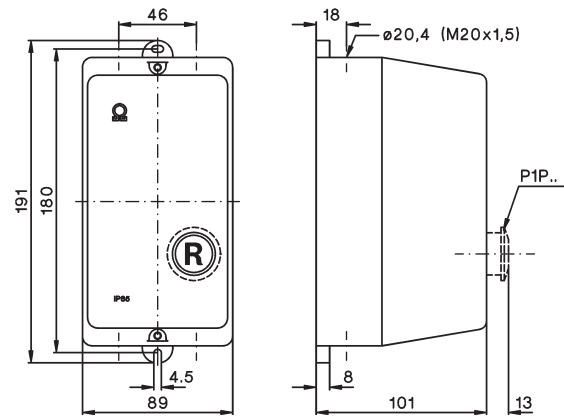

Rear Conduit Entries

knockouts
4 x $\phi 23$

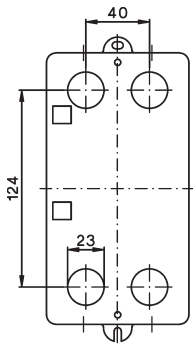

D.O.L. Starters

Mounting and Wiring Instructions

Indicators and Lens Caps for D.O.L. Starters P1

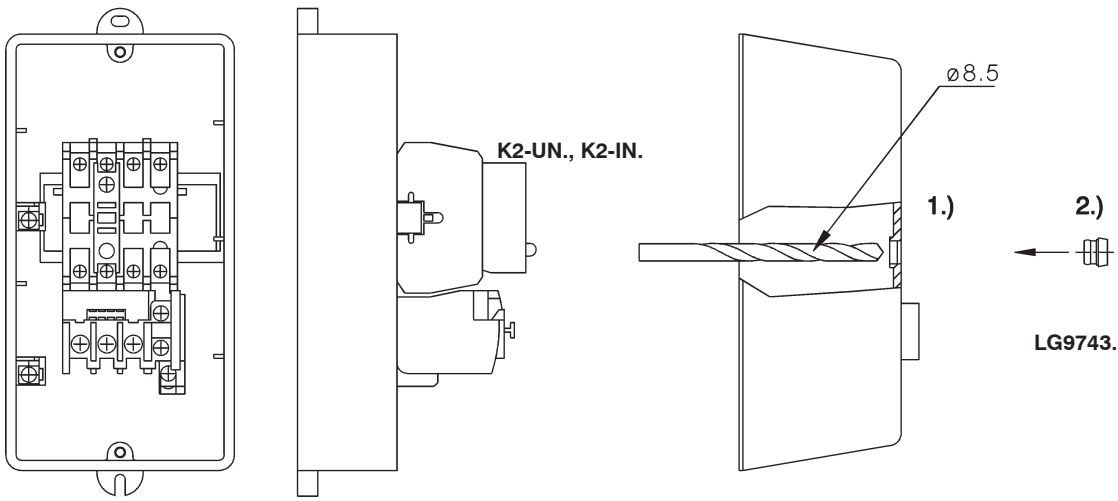

Wiring Examples

Coil Current Indicator

K2-ING
K2-INR

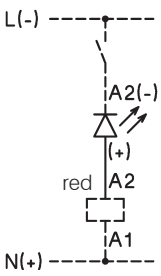

Voltage Indicator

K2-UN
K2-UNR

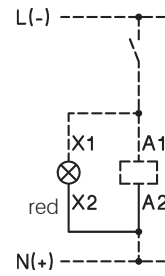

Heating Element

K2-HR

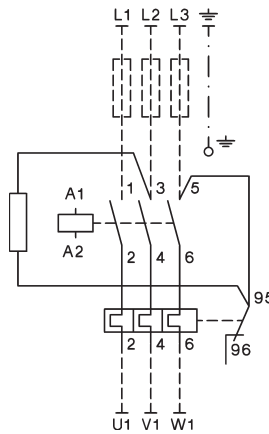

K2-HR 230

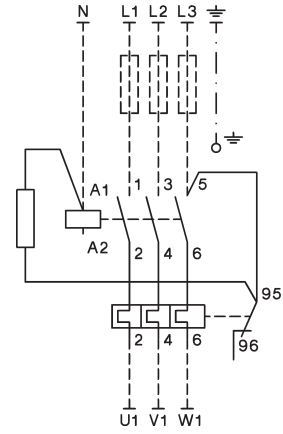

Colour mentioned in wiring diagrams refer to the outgoing connection wire of the device.

Start Contact LG9319-K3 for K3-10ND10 up to K3-22ND10

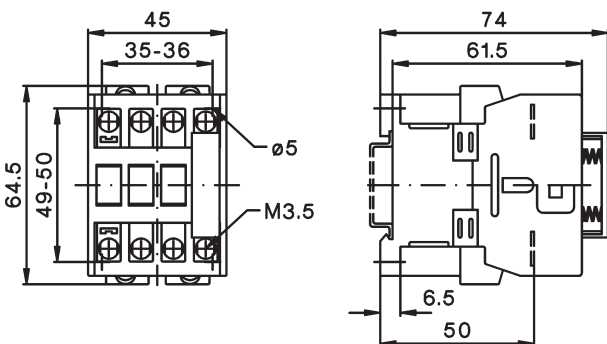



Thermal Overload Relays for Direct Mounting

120

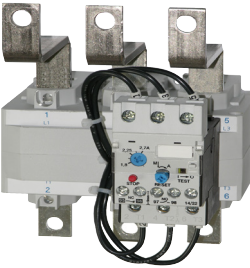

Thermal Overload Relays for Separate Mounting

122



Accessories

123



Technical Data

125

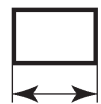

Dimensions

129

Thermal Overload Relays for plug-in mounting

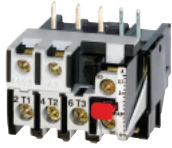

Setting Range
D.O.L. (A) $\Upsilon\Delta$ (A)

Type

Pack Weight
pcs. kg/pc.

Wiring Diagram

With Manual Reset, for contactors K1-..

0,12 - 0,18	-		U12/16E 0,18 K1	1	0,10
0,18 - 0,27	-		U12/16E 0,27 K1	1	0,10
0,27 - 0,4	-		U12/16E 0,4 K1	1	0,10
0,4 - 0,6	-		U12/16E 0,6 K1	1	0,10
0,6 - 0,9	-		U12/16E 0,9 K1	1	0,10
0,8 - 1,2	-		U12/16E 1,2 K1	1	0,10
1,2 - 1,8	-		U12/16E 1,8 K1	1	0,10
1,8 - 2,7	-		U12/16E 2,7 K1	1	0,10
2,7 - 4	-		U12/16E 4 K1	1	0,10
4 - 6	7 - 10,5		U12/16E 6 K1	1	0,10
6 - 9	10,5 - 15,5		U12/16E 9 K1	1	0,10
8 - 11	14 - 19		U12/16E 11 K1	1	0,10
10 - 14	18 - 24		U12/16E 14 K1	1	0,10

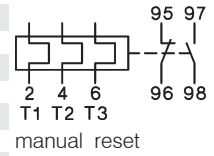

With Auto Reset, for contactors K1-..

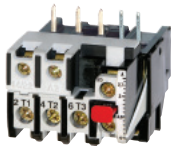

0,12 - 0,18	-		U12/16A 0,18 K1	1	0,10
0,18 - 0,27	-		U12/16A 0,27 K1	1	0,10
0,27 - 0,4	-		U12/16A 0,4 K1	1	0,10
0,4 - 0,6	-		U12/16A 0,6 K1	1	0,10
0,6 - 0,9	-		U12/16A 0,9 K1	1	0,10
0,8 - 1,2	-		U12/16A 1,2 K1	1	0,10
1,2 - 1,8	-		U12/16A 1,8 K1	1	0,10
1,8 - 2,7	-		U12/16A 2,7 K1	1	0,10
2,7 - 4	-		U12/16A 4 K1	1	0,10
4 - 6	7 - 10,5		U12/16A 6 K1	1	0,10
6 - 9	10,5 - 15,5		U12/16A 9 K1	1	0,10
8 - 11	14 - 19		U12/16A 11 K1	1	0,10
10 - 14	18 - 24		U12/16A 14 K1	1	0,10

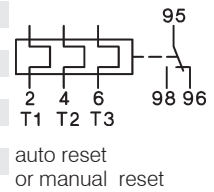

With Quick Tripping Characteristic for EEx e motors and submersible pumps, f. contactors K1-..

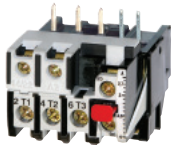

0,4 - 0,6	-		U12/16EQ 0,6 K1	1	0,10
0,6 - 0,9	-		U12/16EQ 0,9 K1	1	0,10
0,8 - 1,2	-		U12/16EQ 1,2 K1	1	0,10
1,2 - 1,8	-		U12/16EQ 1,8 K1	1	0,10
1,8 - 2,7	-		U12/16EQ 2,7 K1	1	0,10
2,7 - 4	-		U12/16EQ 4 K1	1	0,10
4 - 6	7 - 10,5		U12/16EQ 6 K1	1	0,10
6 - 9	10,5 - 15,5		U12/16EQ 9 K1	1	0,10
8 - 11	14 - 19		U12/16EQ 11 K1	1	0,10

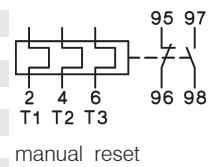

Thermal Overload Relays for plug-in mounting

Contactors, Motor-Starters
 Circuit Breakers
 Manual Motor-Starters
 Switches
 AC-Main Switches
 DC-Switch Disconnectors
 Push Buttons
 Representatives, Suppliers

Setting Range
D.O.L. (A) **YΔ (A)** **Type** Pack pcs. Weight kg/pc. Wiring Diagram

With Manual Reset, for contactors K(G)3-10.. to K(G)3-22.. ..

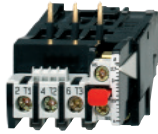

0,12 - 0,18	-		U12/16E 0,18 K3	1	0,10
0,18 - 0,27	-		U12/16E 0,27 K3	1	0,10
0,27 - 0,4	-		U12/16E 0,4 K3	1	0,10
0,4 - 0,6	-		U12/16E 0,6 K3	1	0,10
0,6 - 0,9	-		U12/16E 0,9 K3	1	0,10
0,8 - 1,2	-		U12/16E 1,2 K3	1	0,10
1,2 - 1,8	-		U12/16E 1,8 K3	1	0,10
1,8 - 2,7	-		U12/16E 2,7 K3	1	0,10
2,7 - 4	-		U12/16E 4 K3	1	0,10
4 - 6	7 - 10,5		U12/16E 6 K3	1	0,10
6 - 9	10,5 - 15,5		U12/16E 9 K3	1	0,10
8 - 11	14 - 19		U12/16E 11 K3	1	0,10
10 - 14	18 - 24		U12/16E 14 K3	1	0,10
13 - 18	23 - 31		U12/16E 18 K3	1	0,10
17 - 23	30 - 40		U12/16E 23 K3	1	0,10
22 - 30	38 - 52		U12/16E 30 K3	1	0,13

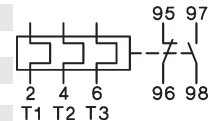

manual reset

With quick Tripping Characteristic for EEx e motors and under water pumps

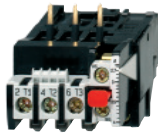

0,4 - 0,6	-		U12/16EQ 0,6 K3	1	0,10
0,6 - 0,9	-		U12/16EQ 0,9 K3	1	0,10
0,8 - 1,2	-		U12/16EQ 1,2 K3	1	0,10
1,2 - 1,8	-		U12/16EQ 1,8 K3	1	0,10
1,8 - 2,7	-		U12/16EQ 2,7 K3	1	0,10
2,7 - 4	-		U12/16EQ 4 K3	1	0,10
4 - 6	7 - 10,5		U12/16EQ 6 K3	1	0,10
6 - 9	10,5 - 15,5		U12/16EQ 9 K3	1	0,10
8 - 11	14 - 19		U12/16EQ 11 K3	1	0,10
10 - 14	18 - 24		U12/16EQ 14 K3	1	0,10

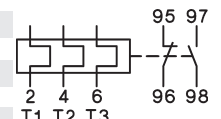

manual reset

For contactors K(G)3-10.. to K(G)3-40A..



0,12 - 0,18	-		U3/32 0,18	1	0,14
0,18 - 0,27	-		U3/32 0,27	1	0,14
0,27 - 0,4	-		U3/32 0,4	1	0,14
0,4 - 0,6	-		U3/32 0,6	1	0,14
0,6 - 0,9	-		U3/32 0,9	1	0,14
0,8 - 1,2	-		U3/32 1,2	1	0,14
1,2 - 1,8	-		U3/32 1,8	1	0,14
1,8 - 2,7	-		U3/32 2,7	1	0,14
2,7 - 4	-		U3/32 4	1	0,14
4 - 6	7 - 10,5		U3/32 6	1	0,14
6 - 9	10,5 - 15,5		U3/32 9	1	0,14
8 - 11	14 - 19		U3/32 11	1	0,14
10 - 14	18 - 24		U3/32 14	1	0,14
13 - 18	23 - 31		U3/32 18	1	0,14
17 - 24	30 - 41		U3/32 24	1	0,14
23 - 32	40 - 55		U3/32 32	1	0,14

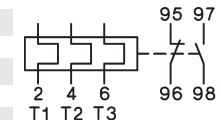

manual and auto reset

For contactors K(G)3-24A.. to K(G)3-40A ..



10 - 14	18 - 24		U3/42 14	1	0,30
14 - 20	24 - 35		U3/42 20	1	0,30
20 - 28	35 - 48		U3/42 28	1	0,30
28 - 42	48 - 73		U3/42 42	1	0,30

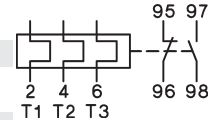

manual and auto reset

Thermal Overload Relays for plug-in mounting



Setting Range
D.O.L. (A) Δ (A)

Type

Pack Weight
pcs. kg/pc.

Wiring Diagram

For contactors K3-50A.. to K3-74A..

20 - 28	35 - 48	U3/74 28	1	0,40
28 - 42	48 - 73	U3/74 42	1	0,40
40 - 52	70 - 90	U3/74 52	1	0,40
52 - 65	90 - 112	U3/74 65	1	0,40
60 - 74	104 - 128	U3/74 74	1	0,40

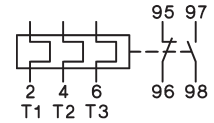

manual and auto reset

Thermal Overload Relays for separate mounting

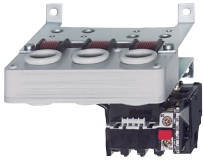

Setting Range
D.O.L. (A) Δ (A)

Type

Pack Weight
pcs. kg/pc.

Wiring Diagram

For contactors K3-90, K3-115, K85, K110

60 - 90	104 - 156	U85 90	1	0,90
80 - 120	140 - 207	U85 120		

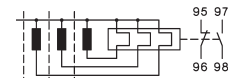

manual reset

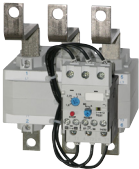

For contactors K3-151.. and K3-176.., busbars included

120 - 180	208 - 312	U180 180	1	1,5
------------------	-----------	-----------------	---	-----

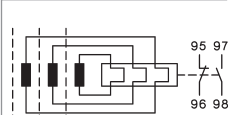

manual and auto reset



For contactors K3-210.. up to K3-316.., busbars included

144 - 216	250 - 374	U320 216	1	1,8
216 - 320	374 - 554	U320 320		

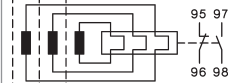

manual and auto reset

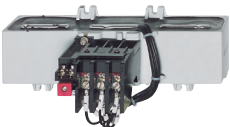

For contactors K3-315.. , K3-450.. , K3-550.. , K3-700.. , K3-860..

240 - 360	416 - 623	U800 360	1	4,1
360 - 540	623 - 935	U800 540	1	4,1
540 - 800	935 - 1385	U800 800	1	4,1

Accessories

for overload relays for contactors

Type

Pack set Weight kg/set



Busbar Sets

U800	K3-450.., K3-550..	SU840/550	1	1,7
U800	K3-700.., K3-860..	SU840/860	1	2,1

Cable Cross-section (mm²) Type

overload relay solid or flexible

stranded

Pack pcs. Weight kg/pc.



for Single Mounting U12/16..K3 Base for DIN-rail mounting plus terminals

U12/16..K3	0,75 - 6	0,75 - 4	U12SM K3	1	0,035
------------	----------	----------	-----------------	---	-------

for Single Mounting U3/32 Additional Terminals with fingertouch protection (U3/32 relays have base for DIN rail mounting integrated)



U3/32	0,75 - 6	0,75 - 4	U3/32SM	1	0,035
-------	----------	----------	----------------	---	-------

for Single Mounting U3/42 or U3/74 Base for DIN-rail mounting



U3/42, U3/74	-	-	U3/42G	1	0,030
--------------	---	---	---------------	---	-------

for Single Mounting U3/42 or U3/74 Connecting Wire Set (3 pcs.)



U3/42, U3/74	150mm length	10mm ²	LG5830-4	1	0,060
U3/42, U3/74	250mm length	10mm ²	LG5830-2	1	0,100

Additional Terminals with fingertouch protection



1-pole f. U12/16, U3/32	0,75 - 10	0,75 - 6	LG9339	1	0,009
-------------------------	-----------	----------	---------------	---	-------

3-pole for U3/42	4 - 35	6 - 25	LG7559	1	0,052
------------------	--------	--------	---------------	---	-------

Thermal Overload Relays, tripping times for selection to motors of protection degree EEx e

Relays With Standard Tripping Characteristic

Setting Range Tripping time depending on the multiple of the current setting from cold condition (tolerance $\pm 20\%$ of the tripping time)

A	A	I_A/I_N 3	I_A/I_N 4	I_A/I_N 5	I_A/I_N 6	I_A/I_N 7,2	I_A/I_N 8
U3/32 ..							
0,12 -	0,18	16,1	9,6	6,8	5,3	4,2	3,7
0,18 -	0,27	16,6	9,7	6,7	5,2	4,1	3,6
0,27 -	0,4	19,4	11,4	7,9	6,1	4,7	4,2
0,4 -	0,6	18,7	10,9	7,6	5,9	4,6	4,0
0,6 -	0,9	19,2	11,2	7,7	5,9	4,6	4,1
0,8 -	1,2	20,8	12,3	8,5	6,6	5,2	4,6
1,2 -	1,8	25,5	14,1	9,8	7,6	5,9	5,2
1,8 -	2,7	26,6	15,6	10,9	8,3	6,5	5,7
2,7 -	4	22,7	13,6	9,5	7,4	5,8	5,1
4 -	6	22,2	13,3	9,3	7,1	5,6	4,9
6 -	9	20,4	11,9	8,2	6,1	4,7	4,0
8 -	11	20,9	11,8	7,9	5,7	4,3	3,5
10 -	14	21,3	11,7	7,4	5,1	3,7	3,0
13 -	18	21,2	12,1	8,0	6,2	4,6	4,1
17 -	24	20,4	12,0	8,6	6,3	4,5	3,7
23 -	32	20,2	10,2	6,7	4,7	3,4	2,8

A	A	I_A/I_N 3	I_A/I_N 4	I_A/I_N 5	I_A/I_N 6	I_A/I_N 7,2	I_A/I_N 8
U3/42							
10 -	14	21,8	11,4	7,0	5,0	3,7	2,8
14 -	20	22,4	11,2	6,7	4,5	3,2	2,4
20 -	28	21,8	10,8	6,5	4,5	3,3	2,5
28 -	42	25,2	13,3	8,0	5,5	4,0	3,1

A	A	I_A/I_N 3	I_A/I_N 4	I_A/I_N 5	I_A/I_N 6	I_A/I_N 7,2	I_A/I_N 8
U3/74							
20 -	28	21,8	10,8	6,5	4,5	3,3	2,5
28 -	42	25,2	13,3	8,0	5,5	4,0	3,1
40 -	52	18,3	9,2	5,6	3,9	2,8	2,2
52 -	65	17,8	8,7	5,2	3,4	2,5	1,9

A	A	I_A/I_N 3	I_A/I_N 4	I_A/I_N 5	I_A/I_N 6	I_A/I_N 7,2	I_A/I_N 8
U85 ..							
60 -	90	19,5	13,5	11,0	10,0	9,5	8,5
80 -	120	18,0	11,0	10,0	9,0	8,5	8,0

A	A	I_A/I_N 3	I_A/I_N 4	I_A/I_N 5	I_A/I_N 6	I_A/I_N 7,2	I_A/I_N 8
U840 ..							
260 -	360	23,3	14,1	10,0	7,6	6,1	5,4
340 -	480	23,0	13,8	9,6	7,6	6,1	5,4
440 -	620	20,5	12,4	9,0	7,0	5,5	5,0
560 -	800	21,0	12,5	9,0	7,0	5,6	5,2

A	A	I_A/I_N 3	I_A/I_N 4	I_A/I_N 5	I_A/I_N 6	I_A/I_N 7,2	I_A/I_N 8
U12/16E(A) ..							
0,12 -	0,18	18,5	10,4	7,2	5,5	4,3	3,6
0,18 -	0,27	16,7	9,8	6,5	5,0	4,1	3,5
0,27 -	0,4	19,4	12,1	8,2	5,9	4,9	4,2
0,4 -	0,6	18,7	11,2	8,0	6,0	4,9	4,1
0,6 -	0,9	19,7	11,6	8,1	6,1	4,9	4,2
0,8 -	1,2	22,9	13,6	10,0	7,3	6,0	5,2
1,2 -	1,8	22,2	13,2	9,2	7,6	5,8	5,3
1,8 -	2,7	23,0	13,7	9,3	7,6	5,7	5,1
2,7 -	4	24,0	14,4	9,9	7,8	5,9	5,1
4 -	6	24,7	13,8	9,9	7,3	5,6	4,8
6 -	9	22,0	13,4	8	5,7	4,1	3,5
8 -	11	17,4	9,2	5,9	4,1	2,9	2,3
10 -	14	26,4	12,9	7,6	5,2	3,5	2,8
13 -	18	14,7	7,7	4,8	3,2	2,3	1,7
17 -	23	16,2	8,4	5,0	3,6	2,4	1,8
22 -	30	16,8	8,5	5,0	3,6	2,3	1,9

Relays With Quick Tripping Characteristic

preferably for motors with short t_E time and for submersible pumps

Setting Range Tripping time depending on the multiple of the current setting from cold condition (tolerance $\pm 20\%$ of the tripping time)

A	A	I_A/I_N 3	I_A/I_N 4	I_A/I_N 5	I_A/I_N 6	I_A/I_N 7,2	I_A/I_N 8
U12/16EQ ..							
0,4 -	0,6	13,6	8,4	5,9	4,2	3,3	3,0
0,6 -	0,9	13,8	7,8	5,2	4,1	3,2	2,7
0,8 -	1,2	13,1	7,5	5,2	3,9	3,1	2,7
1,2 -	1,8	14,6	8,7	6,0	4,6	3,6	3,2
1,8 -	2,7	13,5	7,6	5,3	3,9	3,1	2,7
2,7 -	4	11,0	6,0	4,1	2,6	1,7	1,4
4 -	6	9,6	5,3	3,3	2,3	1,6	1,3
6 -	9	10,2	5,4	3,4	2,3	1,6	1,3
8 -	11	12,0	6,2	3,9	2,5	1,8	1,3
10 -	14	12,8	6,6	4,0	2,6	1,8	1,4

All tripping times of overload relays U12/16EQ are shorter than the minimum values of the t_E time for motors of protection degree EEx e acc. to EN 50019 and therefore are suitable for all motors of protection degree EEx e. For these overload relays the selection on basis of tripping curves is thereby not necessary.

When selecting a standard overload, refer to the tripping curve. Determine the values of the starting current ratio I_A/I_N and the time t_E which is marked on the label of the motor. The overload must trip within the t_E time, which means that the tripping curve from cold condition must be (20% due to tolerance) below the co-ordination point I_A/I_N and the time t_E .

I_A = Starting current of motor I_N = Rated current of motor
 t_E = t_E -time of motor

Time t_E /Tripping time

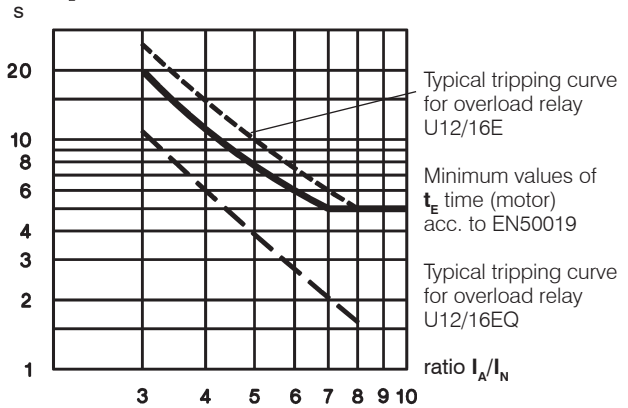

Example of selection for thermal overload relay:

Technical data of a motor protection EEx e
 $P_N = 1,5kW$ $I_N = 3,6A$ $I_A/I_N = 5$ t_E time = 8s

1) U12/16E 4 (2,7 - 4A)
 Tripping time at $5 \times I_N = 9,9s$
 $9,9s + 20\% \text{ tolerance} = 11,9s > t_{E \text{ Motor}} = 8s$
 The device U12/16E 4 is **not suitable**.

2) U12/16EQ 4 (2,7 - 4A)
 Tripping time at $5 \times I_N = 4,1s$
 $4,1s + 20\% \text{ tolerance} = 4,9s < t_{E \text{ Motor}} = 8s$
The device U12/16EQ 4 is therefore suitable for motor protection

Thermal Overload Relays

Fuses for U3/32, U3/42, U3/74, U12/16E, U85, U180, U320 and U800

Type	Setting Range		Max. Fuse Size According to Coordination-type				Fuse UL	SCCR	
	DOL	YΔ	"2" ¹⁾		"1" ¹⁾				
			A	A	quick A	slow, gL(gG) A	slow, gL(gG) A	aM A	A
U3/32 (U12/16E)	0,12 - 0,18	-		0,5 ²⁾	0,5 ²⁾	25	-	15	5
	0,18 - 0,27	-		1,0 ²⁾	1,0 ²⁾	25	-	15	5
	0,27 - 0,4	-		2	2	25	-	15	5
	0,4 - 0,6	-		2	2	25	-	15	5
	0,6 - 0,9	-		4	4	25	-	15	5
	0,8 - 1,2	-		4	4	25	2	15	5
	1,2 - 1,8	-		6	6	25	2	15	5
	1,8 - 2,7	-		10	10	25	4	15	5
	2,7 - 4	-		16	10	25	4	15	5
	4 - 6	7 - 10,5		20	16	25	6	15	5
	6 - 9	10,5 - 15,5		35	25	35	10	25	5
	8 - 11	14 - 19		35	25	35	16	30	5
	10 - 14	18 - 24		50	35	63	16	40	5
13 - 18	23 - 31		50	35	63	20	50	5	
17 - (23)24	30 - (40)41		63	50	63	25	60	5	
(22)23	- (30)32	(38)40 - (52)55	80	63	80	35	70	5	
U3/42	10 - 14	18 - 24	50	35	80	16	40	5	
	14 - 20	24 - 35	63	50	80	25	60	5	
	20 - 28	35 - 48	80	63	80	35	80	5	
	28 - 42	48 - 73	100	80	150	50	110	5	
U3/74	20 - 28	35 - 48	100	80	150	35	80	5	
	28 - 42	48 - 73	125	100	150	50	110	5	
	40 - 52	70 - 90	160	100	150	63	200	5	
	52 - 65	90 - 112	160	125	150	80	250	10	
	60 - 74	104 - 128	160	125	150	80	250	10	
U85	60 - 90	104 - 156					300	10	
	80 - 120	140 - 207					-	10	
U180, U320 U800	all ranges						-	-	
	all ranges						-	-	

For short circuit protecting overload relays with current transformer use fuse according to the contactor of the combination.

Tripping Characteristics for U3/32, U3/42, U3/74 and U12/16E

Detailed tripping times for each range see table page 124

with three-phase load

Tripping time min. s (Average value of typical tolerance curves from cold condition)

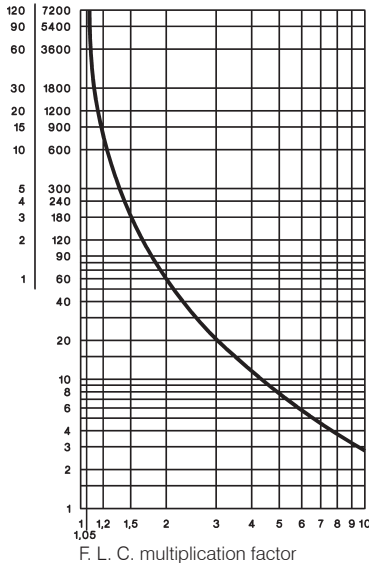

with two-pole load

Tripping time min. s (Typical tolerance curve from cold condition)

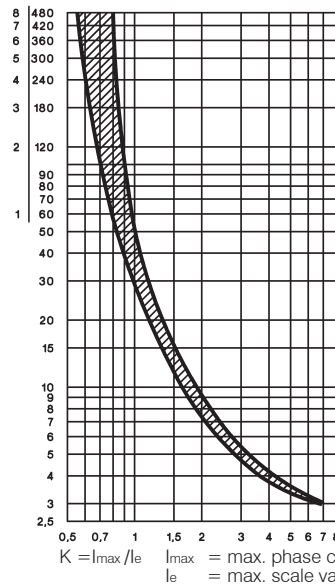

1) Coordination-type according to IEC 947-4-1:
 "2": Light contact welding accepted. Thermal overload relay must not be damaged.
 "1": Welding of contactor and damage of the thermal overload relay allowed.
 2) Miniature fuse

3) Suitable for use on a capability of delivering not more than

Thermal Overload Relays

Tripping Characteristics for U85, U180, U320, and U800

Detailed tripping times for each range of U85 see table page 124

U85 with three-phase load

Tripping time (Average value of typical tolerance curves from cold condition)

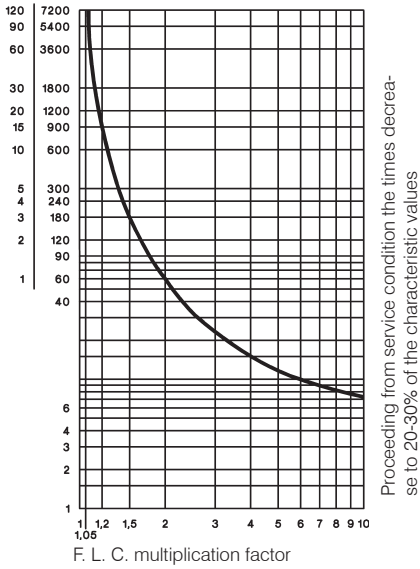

U180, U320 with three-phase load

Tripping time (Average value of typical tolerance curves from cold condition)

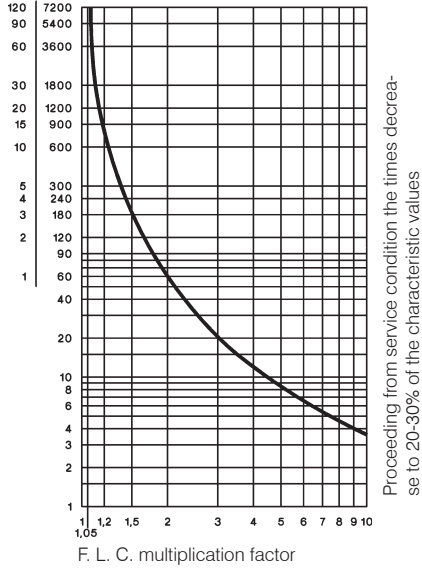

U800 with three-phase load

Tripping time (Average value of typical tolerance curves from cold condition)

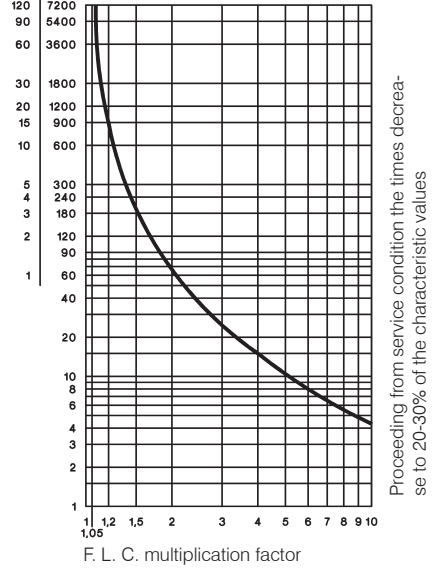

U85 with two-pole load

Tripping time (Typical tolerance curve from cold condition)

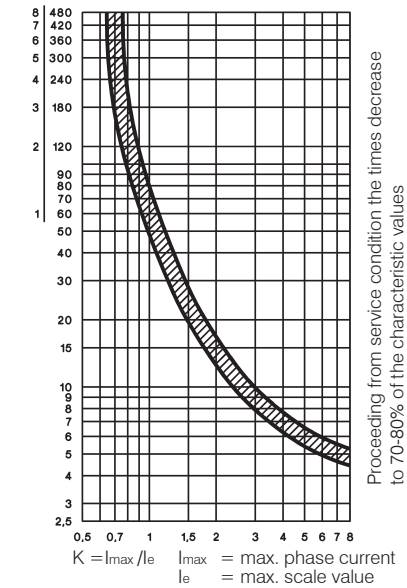

Position of Terminals

U3/32

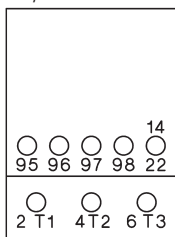

U12/16E, U12/16EM, U12/16EQ

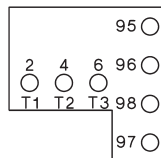

U12/16A

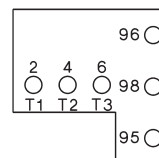

U3/42, U3/74

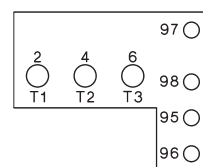

Thermal Overload Relays in Special Version

Fuse for U12/16EQ

Setting Range	Maximum Fuse Acc. to Coordination-type "2" ¹⁾		
	quick A	slow, gL(gG) A	slow, gL(gG) "1" ¹⁾ A
0,4 - 0,6	2	2	25
0,6 - 0,9	4	4	25
0,8 - 1,2	4	4	25
1,2 - 1,8	6	6	25
1,8 - 2,7	10	10	25
2,7 - 4	16	10	25
4 - 6	20	16	25
6 - 9	35	25	35
8 - 11	35	25	35
10 - 14	50	35	63

Fuse for U12/16EM

Setting Range	Maximum Fuse Acc. to Coordination-type "2" ¹⁾		
	380-400V slow, gL(gG) A	500V slow, gL(gG) A	660-690V slow, gL(gG) A
0,12 - 0,18	none	none	on request
0,18 - 0,27	none	none	on request
0,27 - 0,4	none	none	on request
0,4 - 0,6	none	none	on request
0,6 - 0,9	none	none	on request
0,8 - 1,2	none	10	on request
1,2 - 1,8	none	16	on request
1,8 - 2,7	20	20	on request
2,7 - 4	35	35	on request

Tripping Characteristic for U12/16EQ

Detailed tripping times for each range see table page 124

with three-phase load

range 0,4-0,6 to 1,8-2,7A

Tripping time (Typical tolerance curve from cold condition)

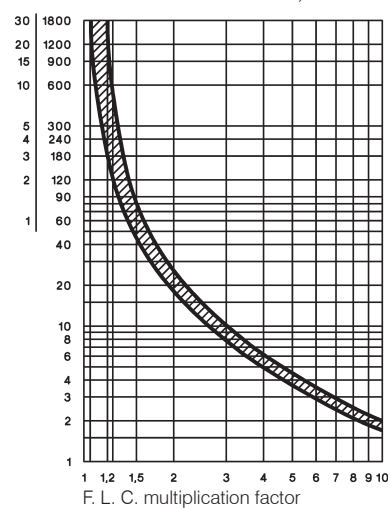

range 2,7-4 to 10-14A

Tripping time (Typical tolerance curve from cold condition)

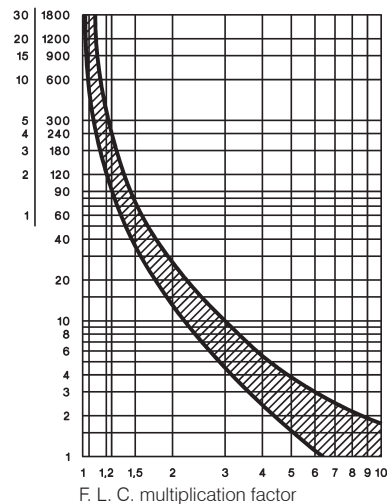

Tripping Characteristic for U12/16EM

with three-phase load

Tripping time (Average value of typical tolerance curves from cold condition)

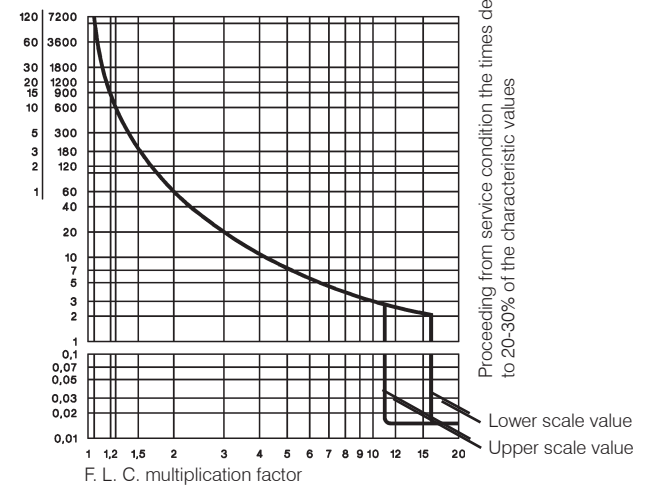

1) Coordination-type according to IEC 947-4-1:
 "2": Light contact welding accepted. Thermal overload relay must not be damaged.
 "1": Welding of contactor and damage of the thermal overload relay allowed.

Thermal Overload Relays

Data according to IEC 947-4-1, IEC 947-5-1, VDE 0660, EN 60947-4-1, EN 60947-5-1

Type	U3/32	U12/16 ⁶⁾	U3/42	U3/74	U85	U180	U320	U800
Rated insulation voltage U_i¹⁾	V~	690	690	690	690	750	1000	1000
Permissible ambient temperature								
operation	open		-25 to +60					-25 to +55
storage			-50 to +70					-40 to +70
Trip class according to IEC 947-4-1	10A	10A	10A	10A	20	10A	10A	10
Cable cross-section								
main connector	solid or stranded	mm ²	0,75-6	0,75-6+0,75-2,5 ²⁾	0,75-10	4-35 ²⁾	3)	7)
	flexible	mm ²	1-4	0,75-4+0,5-2,5 ²⁾	0,75-6	6-25 ²⁾		
	flexible with multicore cable end	mm ²	0,75-4	0,5-2,5+0,5-1,5	0,75-6	4-25		
Cables per clamp	number		2	1+1	2	1		
auxiliary connector	solid	mm ²		0,75-2,5 ²⁾				1-2,5 ²⁾
	flexible	mm ²		0,5-2,5 ²⁾				1-2,5 ²⁾
	flexible with multicore cable end	mm ²		0,5-1,5				1-2,5 ²⁾
Cables per clamp	number			2				2

Type	U3/32	U12/16A	U12/16E	U12/16EQ	U3/42	U85	U180	U800
			U12/16EM		U3/74		U320	
Auxiliary contacts								
Rated insulation voltage U_i¹⁾								
same potential	V~	690	690	690	690	690	690	500
different potential	V~	440	-	440	440	250	440	500
Utilization category AC15								
Rated operational current I _e	24V A	3	4	5	5	4	5	3
	230V A	2	2,5	3	3	2,5	3	2
	400V A	1	1,5	2	2	1,5	2	1
	690V A	0,5	0,6	0,6	0,6	0,6	0,6	0,5
Utilization category DC13								
Rated operational current I _e	24V A	1	1,2	1,2	1,2	1,2	1,2	1
	110V A	0,15	0,15	0,15	0,15	0,15	0,15	0,15
	220V A	0,1	0,1	0,1	0,1	0,1	0,1	0,1
Short circuit prot. (without welding 1kA)								
highest fuse rating	gL (gG) A	4	4	6	6	6	6	4

Type	U3/32	U12/16	U12/16E	U3/42	U3/42	U3/74	U3/74	U85
Setting range	all	to 23A	22 - 30A	to 28A	28 - 42A	to 52A	52 - 65A	all
Power loss per current path (max.)								
minimum setting value	W	1,1	1,1	1,7	1,3	1,3	2,0	2,9
maximum setting value	W	2,3	2,3	3,7	2,6	3,3	3,7	4,5

Data according to cULus

Type	U3/32	U12/16A	U12/16E	U3/42	U3/74	U85
Rated insulation voltage	V~	600	600	600	600	600
Rated current	A	32	23	23	42	75
Auxiliary contacts						
Rated voltage						
same potential	V~	600	600	600	600	600
different potential	V~	150	-	150	150	150
Switching capacity AC	VA	500	500	500	600	600
of aux. contacts	A	2	3	4	4	4

Temperature Compensation

In case of higher ambient temperature use the following formula:
(Ambient temperature - 20) x 0,125 = correction factor in % of the full load motor current

Example: Ambient temperature 70°C, full load motor current 7A
(70 - 20) x 0,125 = 6,25%
Setting value: 7A + 6,25% = 7,44A

1) Suitable for: earthed-neutral systems, overvoltage category I to III, pollution degree 3 (standard-industry): U_{imp} = 4kV (at 440V), 6kV (at 690V).

Data for other conditions on request.

2) Maximum cable cross-section with prepared conductor

3) Without terminals, suitable for bushing one connector 70mm² (stranded) per phase

4) Switching capacity of the start contact: AC15 300VA, max. 1,5A, DC13 (max. 220V) 30W, max. 1,5A

5) Switching capacity of the make contact: AC15 400VA, max. 1,7A, DC13 (max. 220V) 10W, max. 1A

6) U12/16E 30: Cable cross-section for main connector like type U3/42, one connector only

7) Busbar sets see accessories page 123

Thermal Overload Relays

Dimensions

K3-10N + U3/32

K3-14N

K3-18N

K3-22N

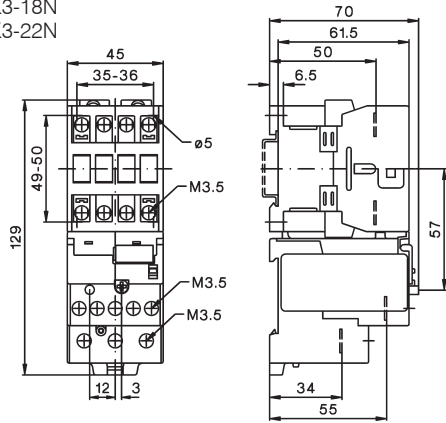

KG3-10 + U3/32

KG3-14

KG3-18

KG3-22

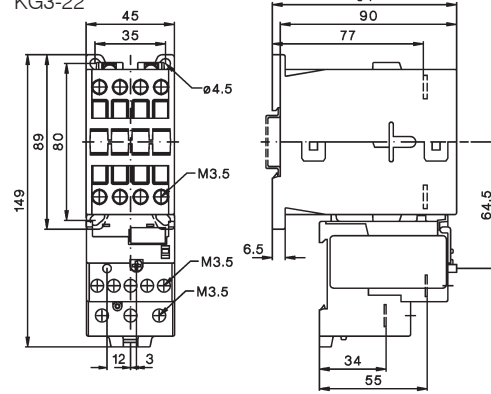

K3-24 + U3/32

K3-32

K3-40

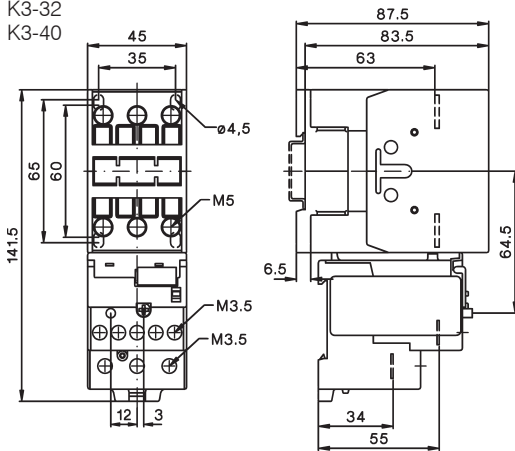

KG3-24 + U3/32

KG3-32

KG3-40

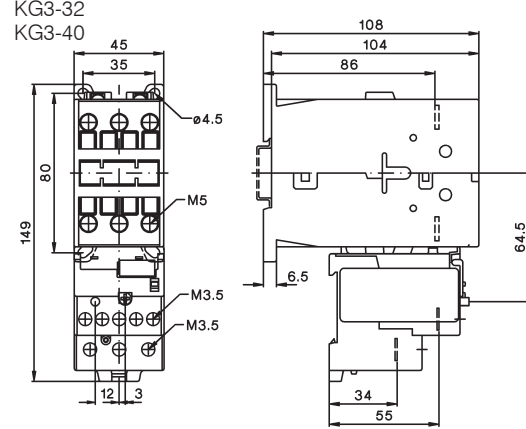

K3-24 + U3/42

K3-32

K3-40

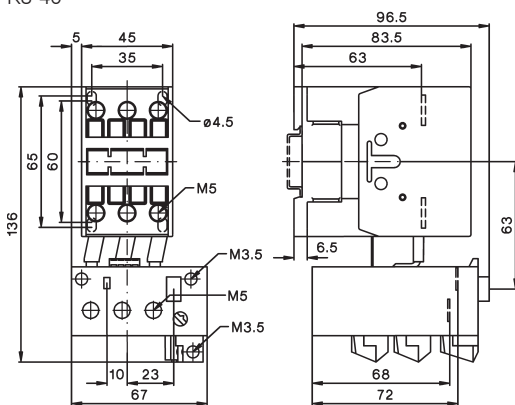

KG3-24 + U3/42

KG3-32

KG3-40

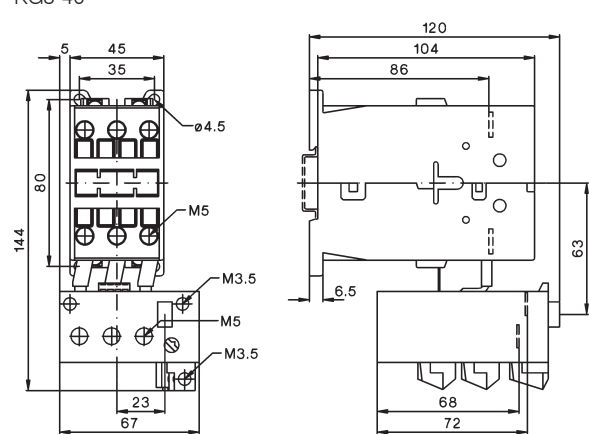

U3/32SM

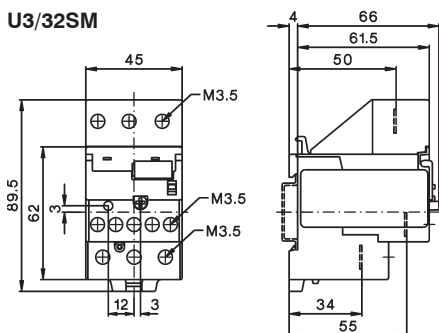

U3/42G + LG5830-

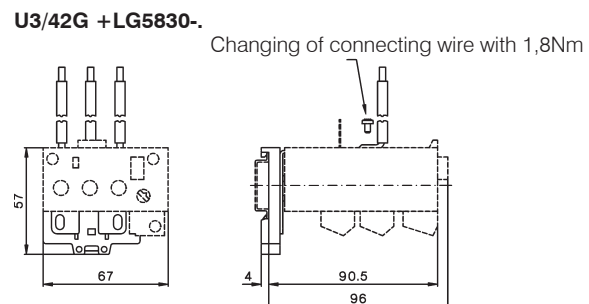

Thermal Overload Relays

Dimensions

K1-09 + U12/16..K1
K1-12

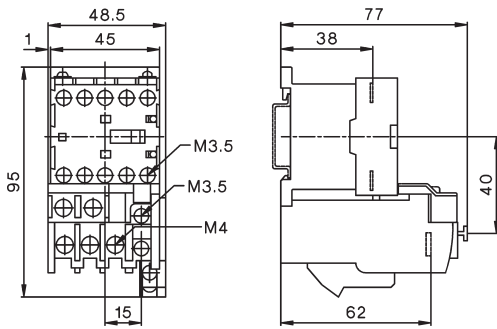

K3-10 + U12/16..K3
K3-14
K3-18
K3-22

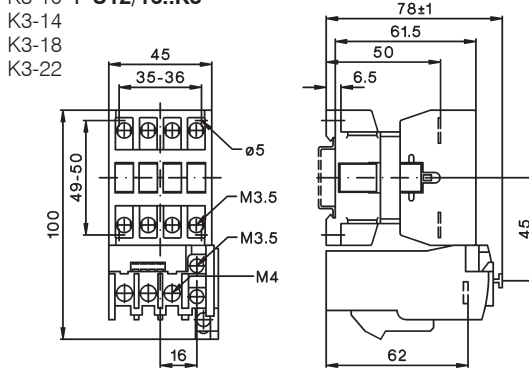

K3-10N + U12/16..K3
K3-14N
K3-18N
K3-22N

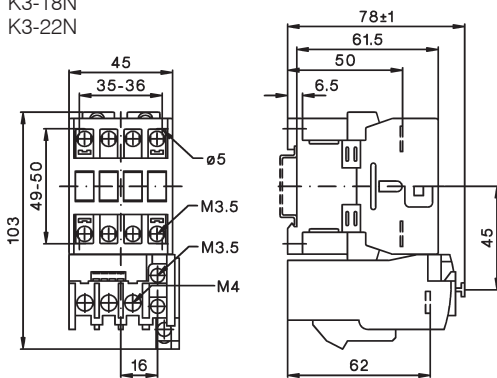

KG3-10 + U12/16..K3
KG3-14
KG3-18
KG3-22

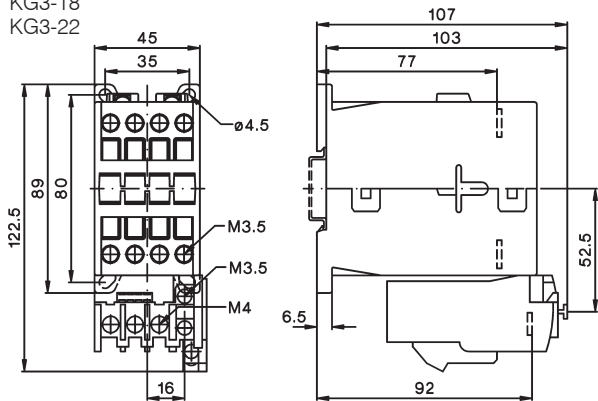

U12SM K3

U12/16..K3 + U12SM K3 for snap-on 35mm DIN-rail according to DIN EN50022 and screw mounting (single mounting)

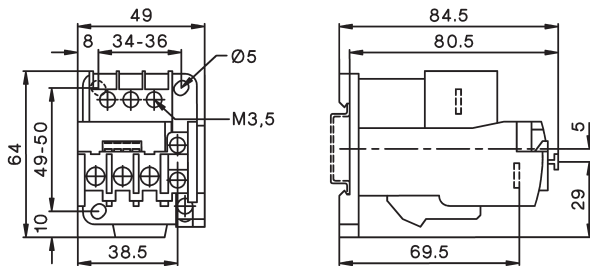

K3-50 + U3/74
K3-62
K3-74

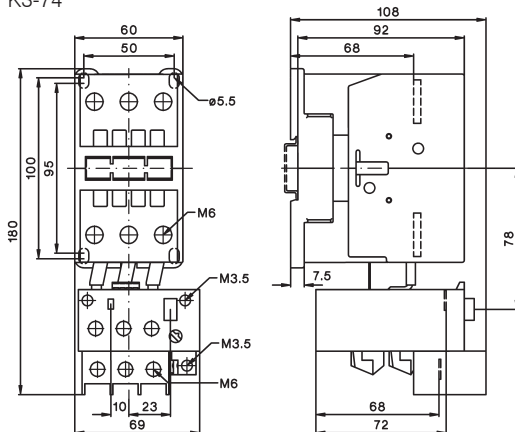

Thermal Overload Relays

Dimensions

K3-90A + U85
K3-115A

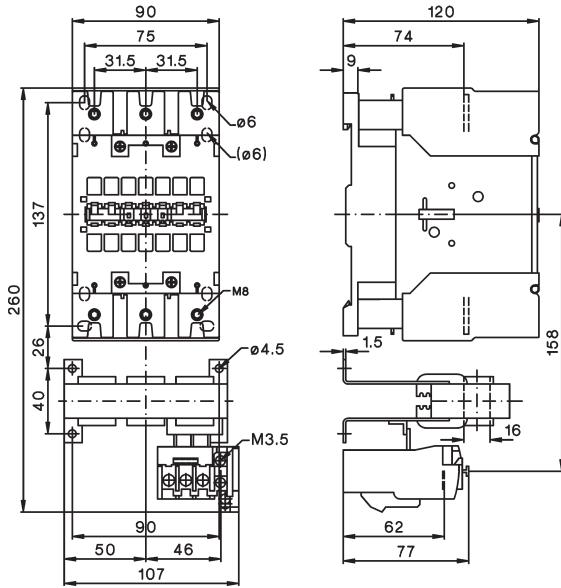

K3-151A00 + U180
K3-176A00

Mounting holes

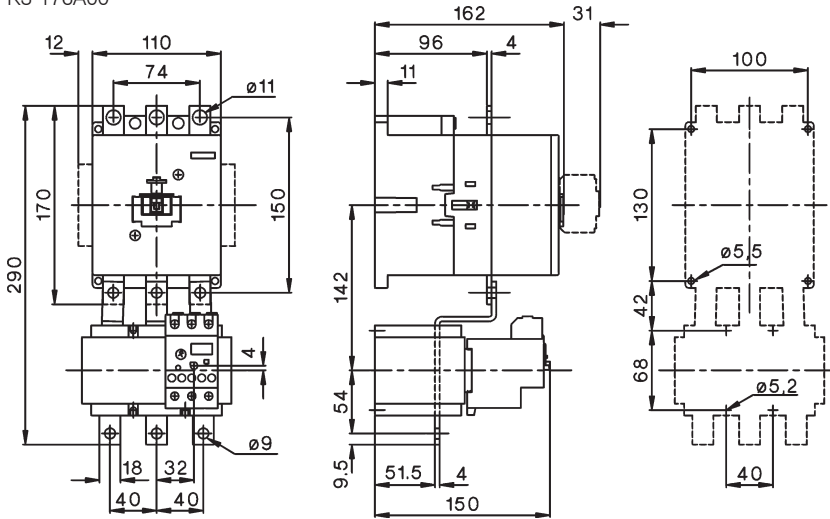

K3-210A00 + U320
K3-260A00
K3-316A00

Mounting holes

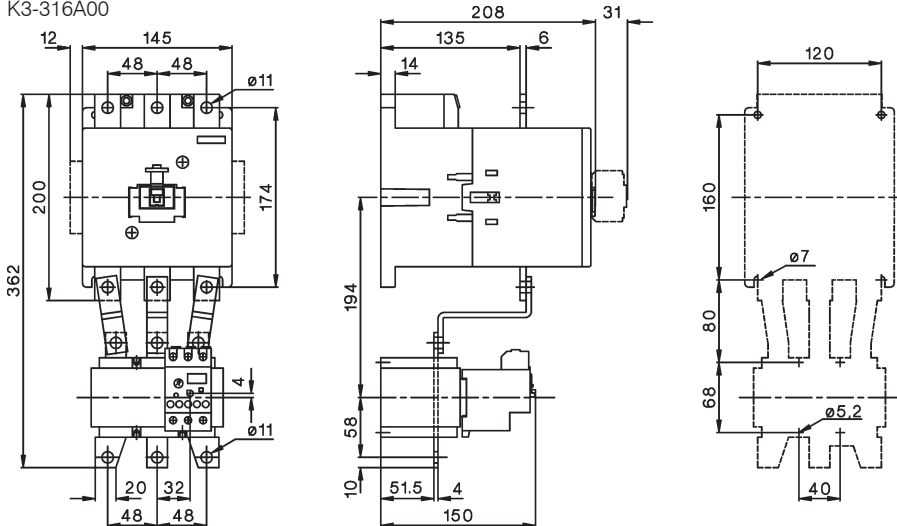



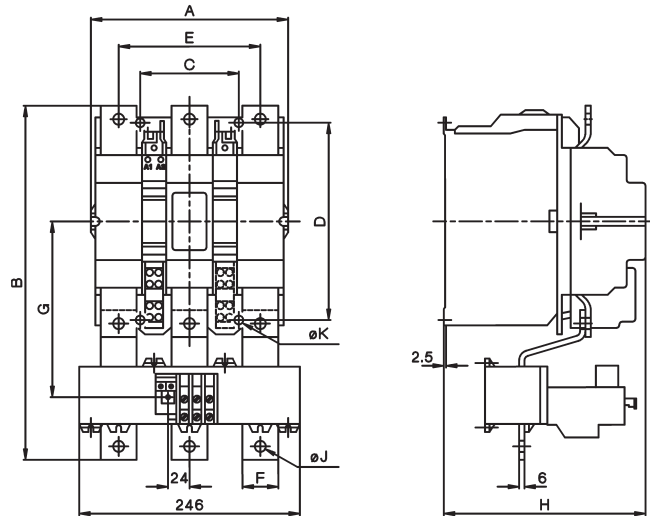
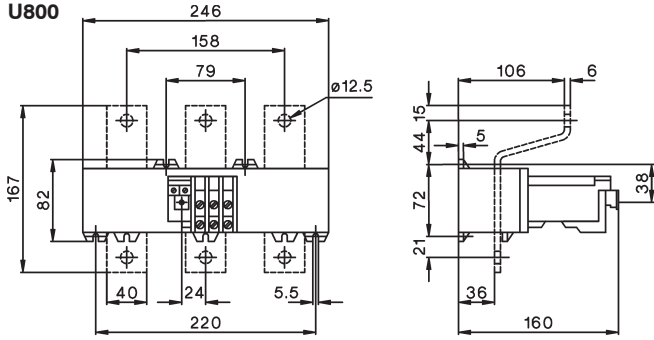

Thermal Overload Relays

Dimensions

U800



U800 with	A	B	C	D	E	F	G	H	J	K
K3-450	220	372	110	220	158	40	185	225	12,5	9
K3-550	220	395	110	220	158	40	196	225	12,5	9
K3-700	280	487	175	280	202	50	257	291	14,5	11
K3-860	280	540	175	280	202	50	280	291	14,5	11

	<p>Modular Contactors</p>	<p>134</p>
	<p>Auxiliary Contact Block Accessories</p>	<p>136 136</p>
	<p>Switching Of Lamps</p>	<p>137</p>
	<p>Technical Data</p>	<p>139</p>
	<p>Dimensions</p>	<p>140</p>

Modular Contactors, low noise

Rated Current	Heating Power AC1 at		Type	coil voltage		Pack pcs.	Weight kg/pc.	Wiring Diagram
	1-phase	3-phase		24	230			
AC1 400V A	230V kW	400V kW			24V 50/60Hz 220-240V 50Hz, 230-264V 60Hz			

One-pole 1 module (17,5mm), AC-operated (low noise)



20	4,6	-	R20-10 24	12	0,12
20	4,6	-	R20-10 230	12	0,12



Two-pole 1 module (17,5mm), AC-operated (low noise)



20	4,6	-	R20-20 24	12	0,12
20	4,6	-	R20-20 230	12	0,12

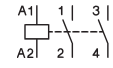

20	4,6	-	R20-11 24	12	0,12
20	4,6	-	R20-11 230	12	0,12

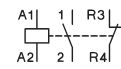

20	4,6	-	R20-02 24	12	0,12
20	4,6	-	R20-02 230	12	0,12

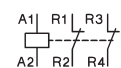

25	5,5	-	R25-20 24	12	0,14
25	5,5	-	R25-20 230	12	0,14

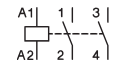

25	5,5	-	R25-11 24	12	0,14
25	5,5	-	R25-11 230	12	0,14

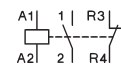

25	5,5	-	R25-02 24	12	0,14
25	5,5	-	R25-02 230	12	0,14

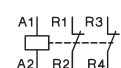

Four-pole 2 modules (35mm)¹⁾, AC-operated (low noise)



25	5,7	17	R25-40 24	6	0,21
25	5,7	17	R25-40 230	6	0,21

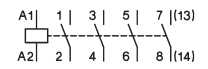

25	5,7	17	R25-31 24	6	0,21
25	5,7	17	R25-31 230	6	0,21

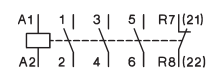

25	5,7	17	R25-13 24	6	0,21
25	5,7	17	R25-13 230	6	0,21

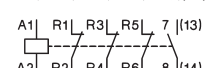

25	5,7	-	R25-22 24	6	0,21
25	5,7	-	R25-22 230	6	0,21

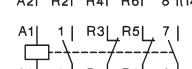

25	5,7	17	R25-04 24	6	0,21
25	5,7	17	R25-04 230	6	0,21

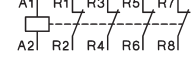

1) Sealable with Sealing Cover P721, available aux. contact block RH11(see page 136)

Modular Contactors, hum free

Rated Current	Heating Power AC1 at		Type	coil voltage		Pack pcs.	Weight kg/pc.	Wiring Diagram
	1-phase	3-phase		24VM	230VM			
400V	230V	400V			24V 50/60Hz, 24V DC			
A	kW	kW		↓	220-240V 50/60Hz, 220V DC			

One-pole 1 module (17,5mm), AC-operated (hum free)

20	4,6	-	R20-10 24VM	12	0,12	
20	4,6	-	R20-10 230VM	12	0,12	

Two-pole 1 module (17,5mm), AC-operated (hum free)

20	4,6	-	R20-20 24VM	12	0,12	
20	4,6	-	R20-20 230VM	12	0,12	
20	4,6	-	R20-11 24VM	12	0,12	
20	4,6	-	R20-11 230VM	12	0,12	
20	4,6	-	R20-02 24VM	12	0,12	
20	4,6	-	R20-02 230VM	12	0,12	



25	5,5	-	R25-20 24VM	12	0,14	
25	5,5	-	R25-20 230VM	12	0,14	
25	5,5	-	R25-11 24VM	12	0,14	
25	5,5	-	R25-11 230VM	12	0,14	
25	5,5	-	R25-02 24VM	12	0,14	
25	5,5	-	R25-02 230VM	12	0,14	

Four-pole 2 modules (35mm) ¹⁾, AC-operated (hum free)

25	5,7	17	R25-40 24VM	6	0,21	
25	5,7	17	R25-40 230VM	6	0,21	
25	5,7	17	R25-31 24VM	6	0,21	
25	5,7	17	R25-31 230VM	6	0,21	
25	5,7	17	R25-13 24VM	6	0,21	
25	5,7	17	R25-13 230VM	6	0,21	
25	5,7	-	R25-22 24VM	6	0,21	
25	5,7	-	R25-22 230VM	6	0,21	
25	5,7	17	R25-04 24VM	6	0,21	
25	5,7	17	R25-04 230VM	6	0,21	



1) Sealable with Sealing Cover P721, available aux. contact block RH11(see page 136)

Modular Contactors, low noise

Rated Current	Heating Power AC1 at	Type	coil voltage	Pack pcs.	Weight kg/pc.	Wiring Diagram
AC1	1-phase 3-phase	24	24V 50/60Hz			
400V	230V 400V	230	220-240V 50Hz, 230-264V 60Hz			
A	kW kW	↓				

Two-pole 2 modules (35mm), AC-operated (low noise)



40	9	-	R40-20 24	6	0,23	
40	9	-	R40-20 230	6	0,23	
40	9	-	R40-02 24	6	0,23	
40	9	-	R40-02 230	6	0,23	
63	14,3	-	R63-20 24	6	0,23	
63	14,3	-	R63-20 230	6	0,23	
63	14,3	-	R63-02 24	6	0,23	
63	14,3	-	R63-02 230	6	0,23	

Four-pole 3 modules (52,5mm)¹⁾, AC-operated (low noise)



40	9	27,5	R40-40 24	4	0,35	
40	9	27,5	R40-40 230	4	0,35	
40	9	27,5	R40-31 24	4	0,35	
40	9	27,5	R40-31 230	4	0,35	
40	9	-	R40-22 24	4	0,35	
40	9	-	R40-22 230	4	0,35	
40	9	27,5	R40-04 24	4	0,35	
40	9	27,5	R40-04 230	4	0,35	
63	14,3	43	R63-40 24	4	0,36	
63	14,3	43	R63-40 230	4	0,36	
63	14,3	43	R63-31 24	4	0,36	
63	14,3	43	R63-31 230	4	0,36	
63	14,3	-	R63-22 24	4	0,36	
63	14,3	-	R63-22 230	4	0,36	
63	14,3	43	R63-04 24	4	0,36	
63	14,3	43	R63-04 230	4	0,36	

Auxiliary Contact Block 1/2 module (8,8mm)²⁾ for contactor R25, R40, R63 (4p.) max. 1 piece for contactor R40 and R63 (2p.) max. 1 piece



Rated current	AC15	AC15	AC1	Type	Pack pcs.	Weight kg/pc.	Wiring Diagram
230V	400V	400V					
A	A	A	for contactor				
3	2	10	R25 ³⁾ , R40, R63	RH11	3	0,026	
3	2	10	R25-..VM (4p.)	RH11-1	3	0,026	

Accessories



Type	Pack pcs.	Weight kg/pc.
RC-unit 2x for R20.. to R63.. for 12V to 250V AC 220nF / 100 Ohm not for R20-..., R25-..VM	RC-R 230	2 0,05
Spacing piece 1/2 module (8,8mm) for R20.. to R63.. for ambient temperature >40°C	P730	10 0,012
Sealing cover for R25.. (4p.)	P721	10 0,002
Sealing cover for R40..., R63..	P690	10 0,003

1) Sealable with Sealing Cover P690, available aux. contact block RH11

2) Contacts suitable for electronic circuits, according to IEC60947-5-4 for rated voltage 24V DC (test ratings 17V DC, 5mA). Mirror contacts acc. IEC60947-4-1 Annex F.

3) AC-operated R25-... 4-pole

Modular Contactors

Switching of lamps

Lamp Type	Power W	Current A	Capacitors μ F	Max. lamps per pole at 230V 50Hz and max. 60°C			
				R20..	R25..	R40..	R63..
Incandescent lamps (AC5b)	60	0,27	-	36	50	92	129
	100	0,45	-	21	30	55	77
	200	0,91	-	10	15	27	38
	300	1,36	-	7	10	19	26
	500	2,27	-	4	6	11	16
	1000	4,5	-	2	3	6	8
Fluorescent lamps uncompensated or serial compensated (AC5a)	11	0,16	1,3	60	75	210	310
	18	0,37	2,7	25	30	90	140
	24	0,35	2,5	25	30	90	140
	36	0,43	3,4	20	25	70	140
	58	0,67	5,3	14	17	45	70
	65	0,67	5,3	13	16	40	65
Fluorescent lamps dual-connection (AC5a)	11	0,07	-	2 x 100	2 x 110	2 x 220	2 x 250
	18	0,11	-	2 x 50	2 x 55	2 x 130	2 x 200
	24	0,14	-	2 x 40	2 x 44	2 x 110	2 x 160
	36	0,22	-	2 x 30	2 x 33	2 x 70	2 x 100
	58	0,35	-	2 x 20	2 x 22	2 x 45	2 x 70
	65	0,35	-	2 x 15	2 x 16	2 x 40	2 x 60
Fluorescent lamps parallel compensated (AC5a)	11	0,09	2	33	43	67	107
	18	0,13	2	25	32	50	80
	24	0,16	3	25	32	50	80
	36	0,27	4	22	32	50	80
	58	0,45	7	14	18	36	46
	65	0,5	7	14	18	36	46
Fluorescent lamps with electronic fluorescent lamp ballast (AC5a)	18	0,09	-	40	40	100	150
	36	0,16	-	20	20	52	75
	58	0,25	-	15	15	30	55
	80	0,4	-	7	10	20	30
	2 x 18	0,17	-	20	20	50	60
	2 x 28	0,25	-	15	15	37	45
2 x 36	0,32	-	10	10	25	30	
2 x 58	0,49	-	7	7	15	20	
2 x 80	0,7	-	4	4	8	10	
Transformers for metal halid low voltage lamps (AC5a)	20	0,09	-	40	52	110	174
	50	0,22	-	20	24	50	80
	75	0,33	-	13	16	35	54
	100	0,43	-	10	12	27	43
	150	0,65	-	7	9	19	29
	200	0,87	-	5	5	14	23
300	1,3	-	3	4	9	14	
Mercury-vapour lamps (high-pressure lamps), uncompensated e. g. HQL, HPL (AC5a)	50	0,61	-	16	21	38	55
	80	0,8	-	12	16	29	40
	125	1,15	-	8	11	20	28
	250	2,15	-	4	6	11	15
	400	3,25	-	3	4	7	10
	700	5,4	-	1	2	4	6
1000	7,5	-	1	1	3	4	
Mercury-vapour lamps (high-pressure lamps), compensated e. g. HQL, HPL (AC5a)	50	0,28	7	14	18	36	50
	80	0,41	8	12	16	31	44
	125	0,65	10	10	13	25	35
	250	1,22	18	5	7	14	19
	400	1,95	25	4	5	10	14
	700	3,45	45	2	3	6	8
1000	4,8	60	1	2	4	6	

Modular Contactors

Switching of lamps

Lamp Type	Power W	Current A	Capacitors μF	Max. lamps per pole at 230V 50Hz and max. 60°C				
				R20..	R25..	R40..	R63..	
Metal halide lamps uncompensated e. g. HQI, HPI, CDM (AC5a)	35	0,53	-	22	24	57	65	
	70	1	-	12	14	30	35	
	150	1,8	-	6	8	17	18	
	250	3	-	4	5	10	12	
	400	3,5	-	3	4	8	10	
	1000	9,5	-	1	1	3	4	
	2000	16,5	-	-	-	2	2	
	400V per pole	2000	10,5	-	-	2	2	
		3500	18	-	-	1	1	
	Metal halide lamps compensated e. g. HQI, HPI, CDM (AC5a)	35	0,25	6	16	21	42	58
70		0,45	12	8	11	21	29	
150		0,75	20	5	7	13	18	
250		1,5	33	3	4	9	11	
400		2,1	35	2	4	9	10	
1000		5,8	95	1	1	3	4	
2000		11,5	148	-	-	2	2	
400V per pole		2000	6,6	58	-	-	3	4
		3500	11,6	100	-	-	2	3
Metal halide lamps with electronic fluorescent with electronic fluorescent lamp ballast (e. g.: PCI) 50-125 x I _{n lamp} for 0,6ms (AC5a)		20	0,1	integrated	9	9	18	20
	28	0,15	integrated	-	-	-	18	
	35	0,2	integrated	6	6	11	13	
	70	0,36	integrated	5	5	10	12	
	150	0,7	integrated	4	4	8	10	
Sodium-vapour lamps (low pressure lamps), uncompensated (AC5a)	35	1,5	-	7	9	22	30	
	55	1,5	-	7	9	22	30	
	90	2,4	-	4	6	13	19	
	135	3,3	-	3	4	10	14	
	150	3,3	-	3	4	10	14	
	180	3,3	-	3	4	10	14	
	200	3,3	-	3	4	10	14	
Sodium-vapour lamps (low pressure lamps), compensated (AC5a)	35	0,31	20	5	6	15	18	
	55	0,42	20	5	6	15	18	
	90	0,63	30	3	4	10	12	
	135	0,94	45	2	3	7	8	
	150	1	40	2	3	8	9	
	180	1,16	40	2	3	8	9	
200	1,32	25	-	-	10	12		
Sodium-vapour lamps (high pressure lamps), uncompensated (AC5a)	150	1,8	-	5	8	17	22	
	250	3	-	4	5	10	13	
	330	3,7	-	3	4	8	10	
	400	4,7	-	2	3	6	8	
1000	10,3	-	1	1	3	4		
Sodium-vapour lamps (high pressure lamps), compensated (AC5a)	150	0,83	20	5	7	20	25	
	250	1,5	33	3	4	12	15	
	330	2	40	2	3	10	13	
	400	2,4	48	2	2	8	12	
1000	6,3	106	1	1	4	6		
Sodium-vapour lamps (high pressure lamps) with serial electronic (e. g.: PCI) 50-125 x I _{n lamp} for 0,6ms (AC5a)	20	0,1	integrated	9	9	18	20	
	35	0,2	integrated	6	6	11	13	
	70	0,36	integrated	5	5	10	12	
	150	0,7	integrated	4	4	8	10	

LED-Lamps

consider the inrush current
of the lamp ballast and
the cosφ of the lamp

max. inrush current of contactor [A]

195A 233A 424A 565A

$$\frac{\text{inrush current of contactor}}{\text{inrush current of lamp/EVG}} =$$

max. lamps per pole at 230V 50Hz and max. 60°C ($I_{n,LED} \leq I_{th}$)

Modular Contactors

Data according to IEC60 947-4-1, IEC 60947-5-1, VDE 0660-5-1

Type	2-pole				4-pole			RH11	
	R20 (VM) ⁷⁾	R25 (VM) ⁷⁾	R40	R63	R25 (VM) ⁷⁾	R40	R63		
Main Contacts ^{4) 5) 6)}									
Rated insulation voltage U_i ¹⁾	V~	440	440	440	440	440	440	440	
Rated operation voltage U_e	V~	440	440	440	440	440	440	440	
Frequency of operations z AC1, AC3	1/h	300	300	600	600	300	600	600	
Mechanical life	S x 10 ⁶	1	1	1	1	1	1	1	
Utilization category AC1 / AC7a									
Switching of resistive load									
Rated operational current I_e (=I _{th}) open	at 60°C A	20	25	40	63	25	40	63	-
Contact life	S x 10 ⁶	0,1	0,1	0,1	0,1	0,1	0,1	0,1	-
Minimum Switch Voltage	V/mA	24/100	24/100	24/100	24/100	24/100	24/100	24/100	17/5
Short time current	10s-current A	72	72	216	240	72	216	240	-
Power loss per pole at I _e /AC1	W	2	3	3	7	2	3	7	0,5
Utilization category AC2 and AC3 / AC7b									
Switching of three-phase motors									
Rated operational current I_e	A	-	-	-	-	9	27	30	-
Rated operational power of three-phase motors									
50-60Hz	220V kW	-	-	-	-	2,2	7,5	8	-
	230-240V kW	-	-	-	-	2,5	8	8,5	-
	380-415V kW	-	-	-	-	4	12,5	15	-
2-pole motors	230V kW	1,1 ²⁾	1,3	2,6	5	-	-	-	-
Contact life	S x 10 ⁶	0,15	0,15	0,15	0,15	0,15	0,15	0,15	-
Power consumption of coils									
AC operated	inrush VA	7 - 9	7 - 9	20 - 25	20 - 25	20 - 25	33 - 45	33 - 45	-
	sealed VA	2,2 - 4,2	2,2 - 4,2	4 - 6	4 - 6	4 - 6	6 - 8	6 - 8	-
	W	0,8 - 1,6	0,8 - 1,6	1,5 - 2,5	1,5 - 2,5	1,5 - 2,5	2,6	2,6	-
AC and DC-operated	W	2 - 3	2 - 3	-	-	3 - 4	-	-	-
Operation range of coils									
in multiples of control voltage U_s (-40° - +40°C)		0,85 - 1,1	0,85 - 1,1	0,85 - 1,1	0,85 - 1,1	0,85 - 1,1	0,85 - 1,1	0,85 - 1,1	-
Noise level (operation) acc. to EN ISO 3744									
from front, distance 0,5 m	dB	16 (0) ⁷⁾	16 (0) ⁷⁾	8	8	8 (0) ⁷⁾	< 4	< 4	-
Type		R20	R25 (2p.)	R25 (4p.)	R25-..VM	R40 (2p./4p.)	R63 (2p./4p.)	RH11	
Maximum ambient temperature									
Operation	open °C				-40 to + 60				
	enclosed °C				-40 to + 40				
Storage	°C				-50 to + 90				≤ 40°C
Short circuit protection									
max. fuse Coordination-type "1" gL (gG)	A	35	35	35	35	63	80	-	
Rated short circuit current	"I _m " kA	3	3	3	3	3	3	-	
	"I _q " kA	3	3	10	10	10	10	-	
Switching time at control voltage $U_s \pm 10\%$									
	make time ms	7 - 16	7 - 16	9 - 15	17 - 50	11 - 15	11 - 15	-	
	release time ms	6 - 12	6 - 12	4 - 8	17 - 23	6 - 13	6 - 13	-	
	arc duration ms	10 - 15	10 - 15	10 - 15	10 - 15	10 - 15	10 - 15	-	
Cable cross-sections									
Main connector	solid or stranded mm ²	1,5 - 10	1,5 - 10	1,5 - 10	1,5 - 10	2,5 - 25	2,5 - 25	0,5 - 2,5 ³⁾	
	flexible mm ²	1,5 - 6	1,5 - 6	1,5 - 6	1,5 - 6	2,5 - 16	2,5 - 16	0,5 - 2,5 ³⁾	
	flexible with multicore cable end mm ²	1,5 - 6	1,5 - 6	1,5 - 6	1,5 - 6	2,5 - 16	2,5 - 16	0,5 - 1,5	
Clamps per pole		1	1	1	1	1	1	2	
Magnetic coil	solid or stranded mm ²	0,75 - 2,5	0,75 - 2,5	0,75 - 2,5	0,75 - 2,5	0,75 - 2,5	0,75 - 2,5	-	
	flexible mm ²	0,5 - 2,5	0,5 - 2,5	0,5 - 2,5	0,5 - 2,5	0,5 - 2,5	0,5 - 2,5	-	
	flexible with multicore cable end mm ²	0,5 - 1,5	0,5 - 2,5	0,5 - 1,5	0,5 - 1,5	0,5 - 1,5	0,5 - 1,5	-	
Clamps per pole		1	1	1	1	1	1	-	
Auxiliary Contacts ^{4) 5) 6)}									
Rated insulation voltage U_i ¹⁾	V AC	-	-	440	440	440	440	440	
Thermal rated current I_{th}	40°C A	-	-	25	25	40	63	10	
Ambient temperature	60°C A	-	-	25	25	40	63	6	

1) Suitable for: earthed-neutral systems, overvoltage category I to III, pollution degree 3 (standard-industry): $U_{imp} = 4kV$.

2) AC7b motor 2-pole 230V 1,1kW

3) Maximum cable cross-section with prepared conductor

4) Rated frequency 50/60Hz

5) Max. occ. switching overvoltage < 4kV

6) Duty cycle: 100%

7) 0 dB for contactors type "VM" (AC/DC operated)

Modular Contactors

Data according to IEC60 947-4-1, IEC 60947-5-1, VDE 0660-5-1

Type	R20	R25 (2p.)	R25 (4p.)	R25-..VM	R40 (2p./4p.)	R63 (2p./4p.)	RH11
Utilization category AC15							
Rated operational current I_e	220-240V A	-	3	3	3	3	3
	380-415V A	-	2	2	2	2	2
	440V A	-	1,6	1,6	1,6	1,6	1,6
Utilization category DC13							
Rated operational current I_e per pole	24-60V A	-	2	2	2	2	2
	110V A	-	0,4	0,4	0,4	0,4	0,4
	220V A	-	0,1	0,1	0,1	0,1	0,1
Short circuit protection							
short-circuit current 1kA, contact welding not accepted max. fuse size	gL (gG) A	-	10	10	10	10	10

Data according to UL508

Main Contacts (cULus)	Type	R20	R25 (2p.)	R25 (4p.)	R40 (2p./4p.)	R63 (2p./4p.)	RH11
Rated operational current "General Use"	A	20	25	25	40	63	10
Rated operational power of three-phase motors at 60Hz (3ph)	110-120V hp	-	-	1	2	3	-
	200-208V hp	-	-	2	5	7½	-
	220-240V hp	-	-	3	7½	10	-
	265-277V hp	-	-	3	7½	10	-
Rated operational power of AC motors at 60Hz (1ph)	110-120V hp	½	½	½	1	1½	-
	200-208V hp	1	1	1	2	3	-
	220-240V hp	1½	1 ½	1½	3	5	-
	265-277V hp	1½	2	2	3	5	-
Fuses	A	40	40	40	80	80	-
Suitable for use on a capability of delivering not more than	rms A	5000	5000	5000	5000	5000	-
	V	300	300	300	300	300	300
Rated operation voltage	V~	300	300	300	300	300	300
Auxiliary Contacts (cULus)	heavy pilot duty AC	-	-	-	-	-	C300

Dimensions

R20-..., R25-... (2-pole)
RC-R 230

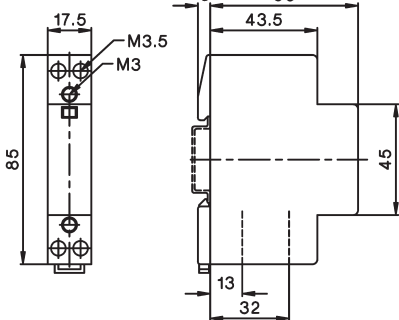

R25-... (4-pole) (+RH11)
R25-..VM (+RH11-1)

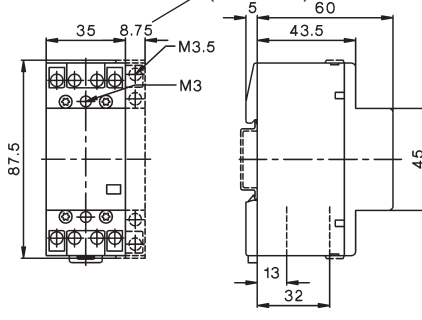

R40-... (2-pole)
R63-... (2-pole)

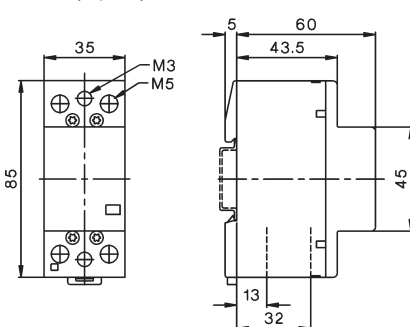

R40-... (4-pole) (+RH11)
R63-... (4-pole) (+RH11)

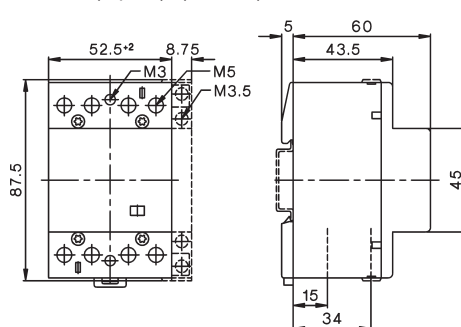

Aux. contact block
RH11, RH11-1

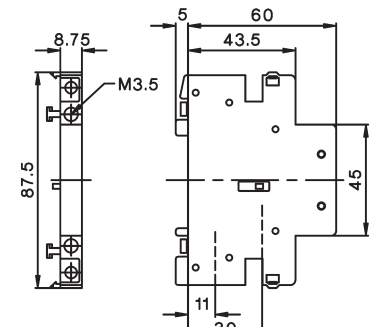

Contactors for DC-Switching

AC-operated

Rated Operational Current

DC1			Additional Aux. Contacts	Type	Coil voltage ¹⁾ 230	Pack pcs.	Weight kg/pcs.	Wiring diagram
600V	1000V	1200V						
20A	-	-	2 HKA11	K3DC-20A00 ...	220-230V 50Hz, 240V 60Hz	1	0,5	
50A	-	-	+1 HKT.	K3DC-48A00 ...		1	0,5	
60A	30A	-	2 HKA11	K3DC-60A00 ...		1	1,2	
80A	60A	-	+1 HKT.	K3DC-80A00 ...		1	1,2	
100A	-	-		K3DC-100A00 ...		1	1,8	
12A	12A	6A	2 HKA11 +2 HKT.	K3PV-12A00 ...		1	0,8	
30A	30A	-	2 HKA11	K3PV-30A00 ...		1	0,9	
60A	60A	-	+2 HKT.	K3PV-60A00 ...		1	0,9	
80A	80A	-	2 HKA11	K3PV-80A00 ...		1	1,5	
100A	100A	-	+1 HKT.	K3PV-100A00 ... ^{2) 3)}		1	2,3	
150A	150A	-	2 HKA11	K3PV-150A00 ... ^{2) 3)}		1	5	
200A	200A	-	+1 HKT.	K3PV-200A00 ... ^{2) 3)}		1	5	
240A	240A	-		K3PV-240A00 ... ^{2) 3)}		1	5	
300A	300A	-	2 HKA11	K3PV-300A00 ... ^{2) 3)}		1	7,5	
400A	400A	-	+1 HKT.	K3PV-400A00 ... ^{2) 3)}		1	7,5	
450A	450A	-		K3PV-450A00 ... ^{2) 3)}		1	7,5	

Contactors for DC-Switching for PV-installations, as remote controlled fire protection defeat device

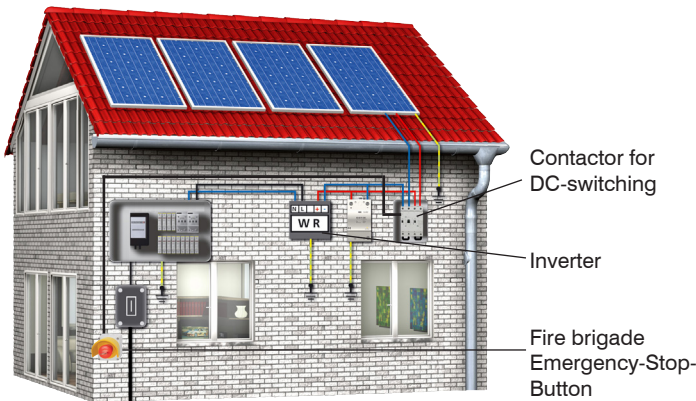

In most Photovoltaic-installations, the switch disconnectors according to IEC 60364-7-712 are integrated in the DC/AC-inverter. So the wires between solar-panels and inverter are continuously under voltage. According to ÖVE-R11-1: 2013, Photovoltaic-installations must have a fire protection defeat device. For this purpose, BENEDICT contactors for DC-switching, used as a fire protection defeat device, can switch off the Photovoltaic-installation with a remote controlled fire brigade Emergency-Stop-button.

Switch diagram (4 contacts)

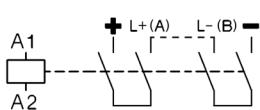

Connection diagram 1-pole: connect L+(A) and L-(B) (jumper attached)

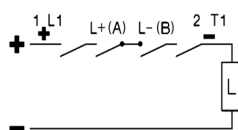



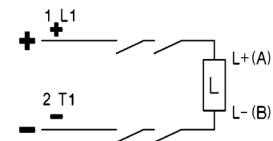







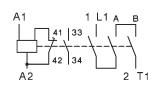

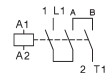
Connection diagram 2-pole: don't use attached jumper

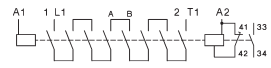

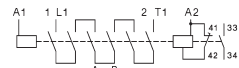

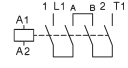
1) Other coil voltages from 24 to 600V AC, on request
 2) Type for AC- and DC-operating: e.g.: 230: 220-240V 50/60Hz and 220V=
 3) With integrated coil suppressor

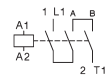
Contactors for DC-Switching

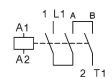
DC-operated

Type	Coil voltage ¹⁾	Aux. Contacts		Pack pcs.	Weight kg/pcs.	Wiring diagram	
	24 24V= DC	build in NO NC	additional Type				
	↓	1	-	1 HKA11	1	0,5	
K3DC-48A10= ...⁵⁾		1	-	+1 HKT.	1	0,5	
	↓	-	-	1 HKA11	1	1,2	
K3DC-80A00= ...⁵⁾		-	-	+1 HKT.	1	1,2	
K3DC-100A00= ...⁵⁾		-	-		1	1,8	
	↓	1	-	1 HKA11 +2 HKT.	1	0,85	
K3PV-30A10= ...⁵⁾		1	-	1 HKA11	1	0,95	
	↓	1	-	+2 HKT.	1	0,95	
K3PV-80A00= ...⁵⁾		-	-	2 HKA11	1	1,5	
	↓	-	-	+1 HKT.	1	2,3	
K3PV-100A00 ...^{2) 5)}		-	-		1	2,3	
	↓	-	-	2 HKA11	1	5	
K3PV-200A00 ...^{2) 5)}		-	-	+1 HKT.	1	5	
K3PV-240A00 ...^{2) 5)}		-	-		1	5	
	↓	-	-	2 HKA11	1	7,5	
K3PV-400A00 ...^{2) 5)}		-	-	+1 HKT.	1	7,5	
K3PV-450A00 ...^{2) 5)}		-	-		1	7,5	

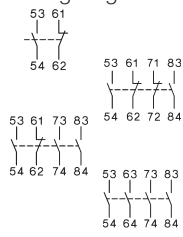
Auxiliary Contact Blocks for contactors K3DC-.. and K3PV-.., for low level switching⁴⁾

Type	Rated Operational Current			for contactors	Type	Pack pcs.	Weight kg/pcs.	Wiring diagrams
	AC15	AC15	AC1					
	230V	400V	690V		HKT11	1	0,04	
3	2	10	K3DC, K3PV-.. top		HKT22	1	0,05	
3	2	10	K3DC, K3PV-.. top		HKT31	1	0,05	
3	2	10	K3DC, K3PV-.. top		HKT40	1	0,05	
	3	2	10	K3DC, K3PV-.. side	HKA11	1	0,05	

Accessories



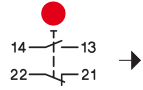











Fire Brigade-EMERGENCY STOP key operated button Ø40mm, according to EN418, unlock by key	BG10P44S3-11 +SK	1	0,22		3)
---	-------------------------	---	------	---	----

1) Other coil voltages from 24 to 250V DC, on request
 2) Type for AC- and DC-operating: e.g.: 24: 24V 50/60Hz and 24V=
 3) → opener positive opening acc. IEC/EN60947-5-1
 4) Contacts suitable for electronic circuits, according to IEC60947-5-4 for rated voltage 24V DC (test ratings 17V DC, 5mA) Mirror contacts acc. IEC60947-4-1 Annex F. Technical data see page 78
 5) With integrated coil suppressor

Technical Data

Data according to IEC 60947-4-1, VDE 0660

Type		K3DC-20..	K3DC-48..	K3DC-60..	K3DC-80..	K3DC-100..	K3PV-12..	K3PV-30..	K3PV-60..	K3PV-80..	K3PV-100..	K3PV-150..	K3PV-200..	K3PV-240..	K3PV-300..	K3PV-400..	K3PV-450..		
Rated insulation voltage U_{imp}	V= kV	600 8	600 8	1000 8	1000 8	600 8	1200 8	1000 8	1000 8	1000 8	1000 8	1000 8	1000 8	1000 8	1000 8	1000 8	1000 8		
poles in series		3	3	3	3	3	8	6	6	4	4	3	3	3	3	3	3		
DC1 600V dc	I_e A	20	50	60	80	100	12	30	60	80	100	150	200	240	300	400	450		
DC1 1000V dc	I_e A	-	-	30	60	-	12	30	60	80	100	150	200	240	300	400	450		
DC1 1200V dc	I_e A	-	-	-	-	-	6	-	-	-	-	-	-	-	-	-	-		
DC3/5 310V dc	I_e A	-	-	-	40	60	-	15	24	40	90	125	170	200	230	270	300		
DC3/5 460V dc	I_e A	-	-	-	-	-	-	15	24	40	40	125	170	200	230	270	300		
DC3/5 600V dc	I_e A	-	-	-	-	-	-	-	-	-	-	50	60	75	120	160	200		
Main pole resistance	mOhm	1,8	1,8	1,4	1,2	1	2,2	1,8	1,8	1,2	1	0,5	0,5	0,35	0,15	0,15	0,15		
poles in series resistance	mOhm	5,4	5,4	4,2	3,6	3	17,6	10,8	10,8	4,8	4	1,5	1,5	1,1	0,5	0,5	0,5		
Mechanical life	10^6	10										10			8				
Protection degree		IP20										IP00 / IP20 ¹⁾			IP00 / IP20 ¹⁾				
Main poles																			
Cable cross sections	mm ²	2 x 1,5 - 10		2,5 - 35		4 - 35 +4-50		2x 1,5-2,5		2 x 1,5 - 10		2,5-35		4 - 35 +4 - 50		Busbar 18 x 4 Screw M8		Busbar 25 x 6 Screw M10	
Tightening torque	Nm	2,3 - 2,7		5 - 6		8 - 9,6		1,4 - 1,6		2,3 - 2,7		5 - 6		8 - 9,6		17 - 20		35 - 42	
Mounting		DIN-rail or screw				screws		DIN-rail or screws				Screws		Screws		Screws			
Operating range of coils	Uc	0,85 - 1,1																	
Power consumption of coils																			
AC inrush sealed	VA VA/W	90 9 / 3		250 18 / 4		180 18 / 6		250 18 / 4		350 5 / 5		360 6 / 6							
DC inrush sealed	W W	120 2		230 4		230 5		230 4		350 5		360 6							
Switching time																			
AC make time	ms	10 - 25		12 - 30		12 - 30		10 - 25		12 - 30		15 - 50		30 - 60		40 - 60			
AC release time	ms	6 - 18		6 - 15		6 - 15		6 - 18		6 - 15		30 - 80		30 - 80		40 - 60			
DC make time	ms	15 - 25		15 - 25		20 - 30		15 - 25		15 - 25		15 - 50		30 - 60		40 - 60			
DC release time	ms	40 - 70		10 - 25		10 - 25		40 - 70		10 - 25		30 - 80		30 - 80		40 - 60			
Maximum ambient temperature																			
Operation °C		-40 to +40 (+70) ²⁾																	
Storage °C		-40 to +70																	
Short circuit protection for contactors																			
Coordination-type „1“ max. fuse size gPV																			
600VDC A		63	80	-	-	160	-	-	-	-	-	160	200	250	-	-	-		
1000VDC A		-	-	-	-	-	12	63	100	-	160	160	200	250	315	400	500		
Coordination-type „2“ max. fuse size gPV																			
600VDC A		50	63	80	100	125	-	-	-	100	-	-	-	-	-	-	-		
1000VDC A		-	-	80	100	-	-	50	80	100	125	-	-	-	-	-	-		
Short-circuit current	kA	3	3	3	3	5	3	3	3	5	5	10	10	10	10	10	10		

Data according to UL60947-4-1 

Type		K3DC-20..	K3DC-48..	K3DC-60..	K3DC-80..	K3PV-80..	K3PV-150..	K3PV-200..	K3PV-240..	K3PV-300..	K3PV-400..	K3PV-450..
General Use I_e [A]	600V DC	20	40	60	80	80	130	160	200	300	330	360
	1000V DC	-	-	30	60	80	130	160	200	300	330	360
Motor Control I_e [A]	220-240V DC	12	20	38	55	72	89	106	140	173	206	255
	500V DC	12	16	34	51	67	83	99	123	164	205	246
	550-600V DC	12	16	38	46	61	90	111	148	185	222	294

1) IP20 w. terminal lug.

2) > 40° ... 1% / C° de-rating (eg. at 60°C 20% de-rating)

Dimensions

K3DC-20A00, K3DC-48A00

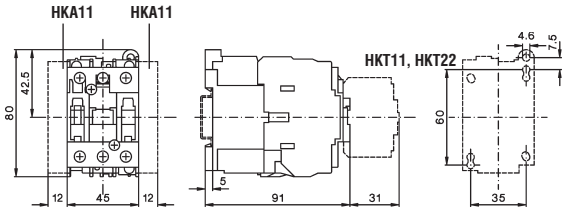

K3DC-20A10=, K3DC-48A10=

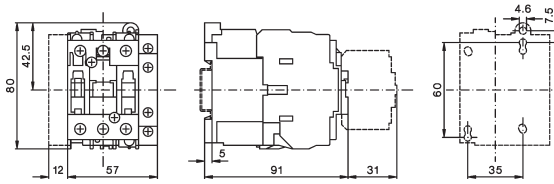

K3DC-60A00(=), K3DC-80A00(=)

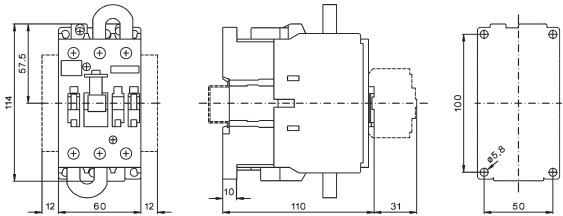

K3DC-100A00(=)

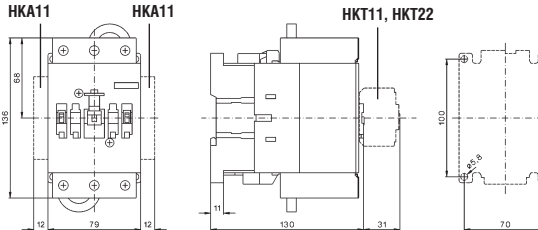

K3PV-12A00

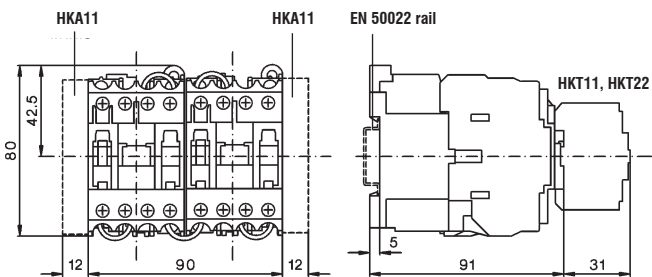

K3PV-12A10=

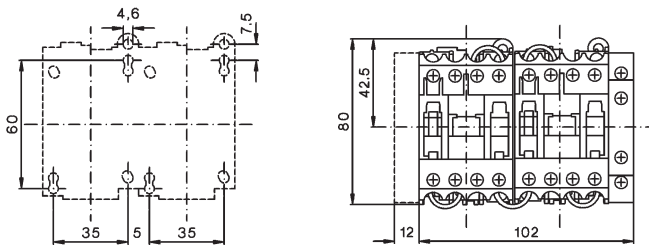

K3PV-30A00, K3PV-60A00

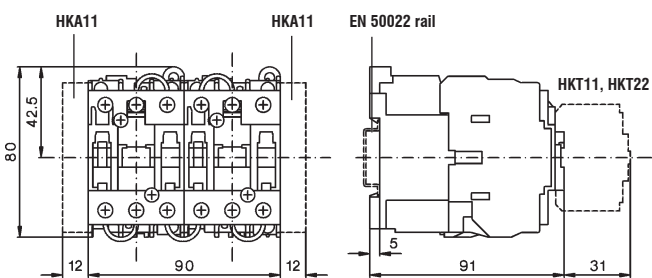

K3PV-30A10=, K3PV-60A10=

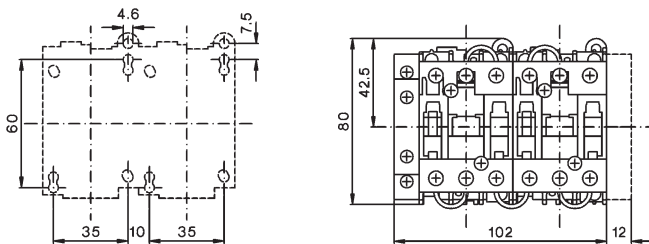

K3PV-80A00(=)

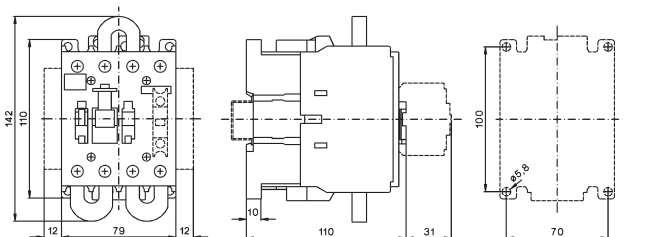

K3PV-100A00(=)

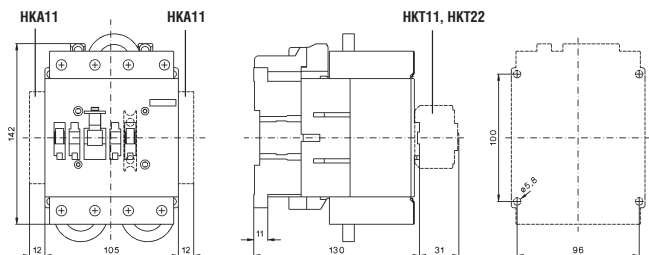

K3PV-150A00(=), K3PV-200A00(=), K3PV-240A00(=)

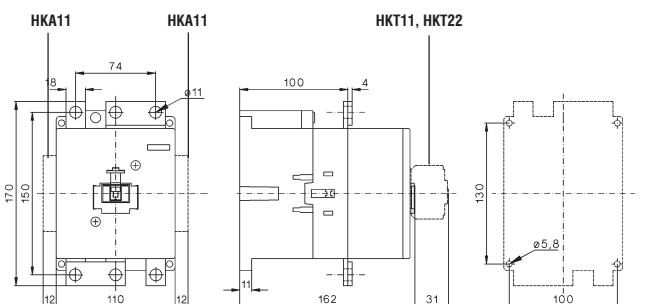

K3PV-300A00(=), K3PV-400A00(=), K3PV-450A00(=)

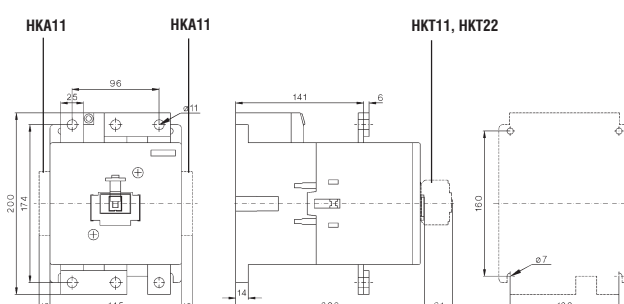

	Contactors RAST 5 Contactor Relays Contactors	147 147 147
	Accessories Auxilliary Contact Blocks	147 147
	Combinations Contactors for Fuseless Load Feeder Contactors for Overload Relays	148 148 148
	Industry Standard RAST 5 Contactor-Housing Coil-Housing Auxilliary Contact Block-Housing	149 150 157
	System Stocko RAST 5 Contactor-Housing Coil-Housing Auxilliary Contact Block-Housing	151 152 158
	System Tyco RAST 5 Contactor-Housing Coil-Housing Auxilliary Contact Block-Housing	153 154 159
	System Lumberg RAST 5 Contactor-Housing Coil-Housing Auxilliary Contact Block-Housing	155 156 160
	Dimensions / Color Codes	161
	Technical Information	162

RAST 5 - exclusiv for OEM-Partner

5 mm pitch connector system

Advantages RAST 5 - Technology

- Time saving installation
- Easy assembly without tools
- Tailor-made sockets, custom - designed codes
- Ambient temperatures up to +90°C/194°F
- Smallest sizes
- Plug technology up to 32 A / 415 V
- color coding for power ratings
- color coding for coil voltages

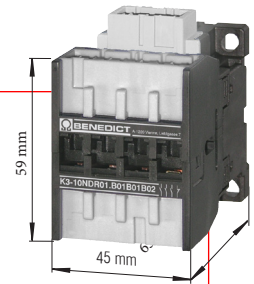

RAST 5 - Accessories



Combining switchgears with plug-in connections and screw connections

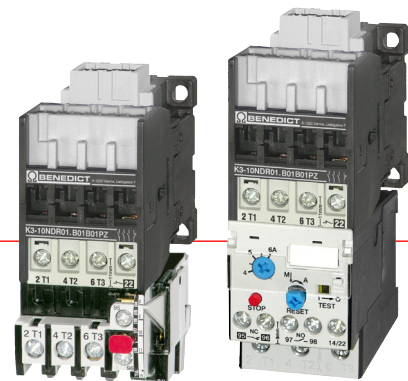

Contactors are available for plugs of many different producers

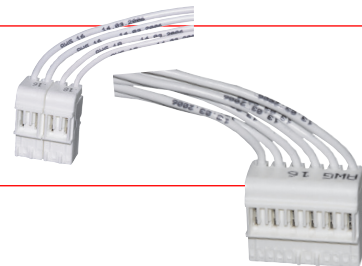

Contactors, RAST 5





AC operated

Ratings AC2, AC3 380V 400V 220V 415V 230V kW kW kW			Rated- Current AC1 415V A	Auxilliary Contacts built in NO NC		Auxilliary Contacts snap on HN10R..	Type	Coil Voltage	Code Housing Coil	Code Housing IN (L)	Code Housing OUT (T)	Pack pcs.	Weight kg/pc.
--	--	--	---------------------------------------	---	--	--	------	--------------	-------------------	---------------------	----------------------	-----------	---------------

● Contactor Relays

	-	-	-	10	4	-	2	K3-07NDR40				1	0,23
	-	-	-	10	2	2	2	K3-07NDR22				1	0,23

● Contactors

	4	3	3	25	1	-	2	K3-10NDR10				1	0,23
	4	3	3	25	-	1	2	K3-10NDR01				1	0,23
	5,5	4	4	25	1	-	2	K3-14NDR10				1	0,23
	5,5	4	4	25	-	1	2	K3-14NDR01				1	0,23
	7,5	5	5	32	1	-	2	K3-18NDR10				1	0,23
	7,5	5	5	32	-	1	2	K3-18NDR01				1	0,23
	11	6	7	32	1	-	2	K3-22NDR10				1	0,23
	11	6	7	32	-	1	2	K3-22NDR01				1	0,23

Auxilliary

● Auxilliary Contact Blocks

for Contactors	AC15 230V A	I _{th} A	Contacts NO NC		Type	Pack pcs.	Weight kg/pc.
	K3-..R..	3	10	1	-	HN10R	10, 0,02
	K3-..R..	3	10	-	1	HN01R	10, 0,02

Order Example for Contactors:

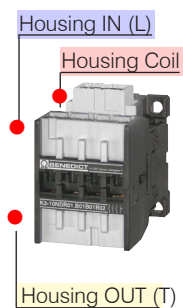
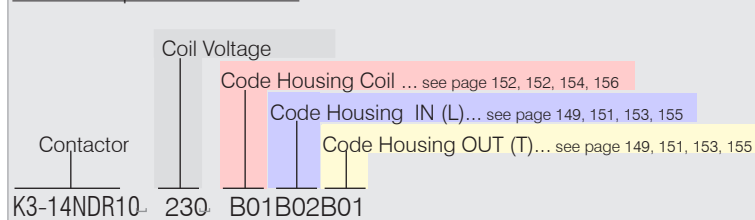

Technical data are subject to change without notice

Contactors, RAST 5 Combinations

AC operated

Motor
 AC2, AC3
 380V AC3
 400V 400V
 415V 415V
kW A





for
 Overload Relays
 U12/16E.. and U3/32...

Type

Coil Voltage
 Code Housing Coil
 Code Housing IN (L)
 Screw Connection OUT (T)

Pack Weight
 pcs. kg/pcs.

● Contactors for Overload Relays

	4	10	U12/16E 0,18-..23 K3 and U3/32 0,18-..32	K3-10NDR10	PZ	1	0,23
	4	10	U12/16E 0,18-..23 K3 and U3/32 0,18-..32	K3-10NDR01	PZ	1	0,23
	5,5	14	U12/16E 0,18-..23 K3 and U3/32 0,18-..32	K3-14NDR10	PZ	1	0,23
	5,5	14	U12/16E 0,18-..23 K3 and U3/32 0,18-..32	K3-14NDR01	PZ	1	0,23
	7,5	18	U12/16E 0,18-..23 K3 and U3/32 0,18-..32	K3-18NDR10	PZ	1	0,23
	7,5	18	U12/16E 0,18-..23 K3 and U3/32 0,18-..32	K3-18NDR01	PZ	1	0,23
	11	22	U12/16E 0,18-..23 K3 and U3/32 0,18-..32	K3-22NDR10	PZ	1	0,23
	11	22	U12/16E 0,18-..23 K3 and U3/32 0,18-..32	K3-22NDR01	PZ	1	0,23

Pozidriv ... PZ
 Torx TX

Selection of Contactor-Housings for Standard plugs acc. **Industry Standard RAST 5**

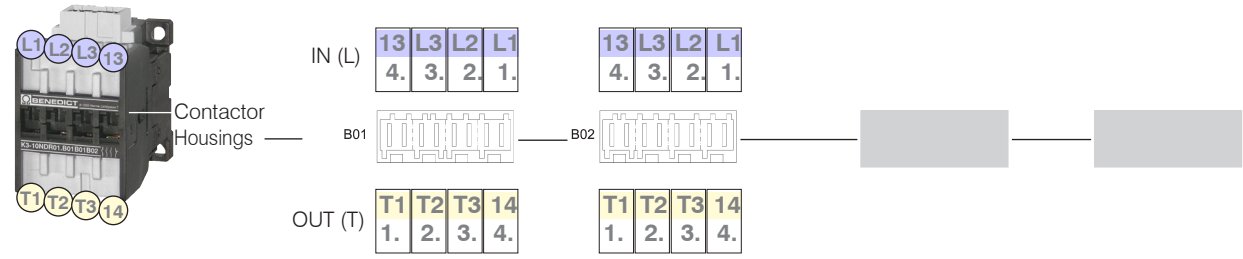

Code Contactor-Housings — **B01** — **B02** — **B03** — **B04** further housings on request →

Standard plugs acc. Industry Standard RAST 5



	B01	B02	B03	B04
8-pole				
6-pole left				
6-pole right				
4-pole left		-0A-		
4-pole right		-0B-		-0B-
2-pole left				-0A- -0C- -0I- -0L- -0O- -0Q-
2-pole center left		-0A- -0C-		-0K-
		-0O- -0Q-		
2-pole center right				-0B- -0F- -0K- -0L-
2-pole right				-0B- -0F- -0I- -0L-

Order Example for Contactors:

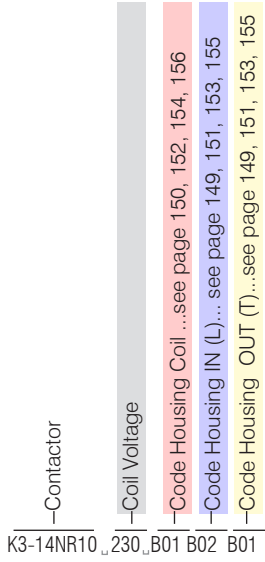

Selection of Coil-Housings for Standard plugs acc. **Industry Standard RAST 5**



Coil-Housings

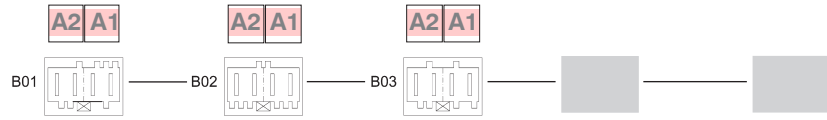

Code Coil-Housings ————— **B01** ————— **B02** ————— **B03** ————— **B04** ————— **B05** ————— further housings on request →

Standard plugs acc. Industry Standard RAST 5

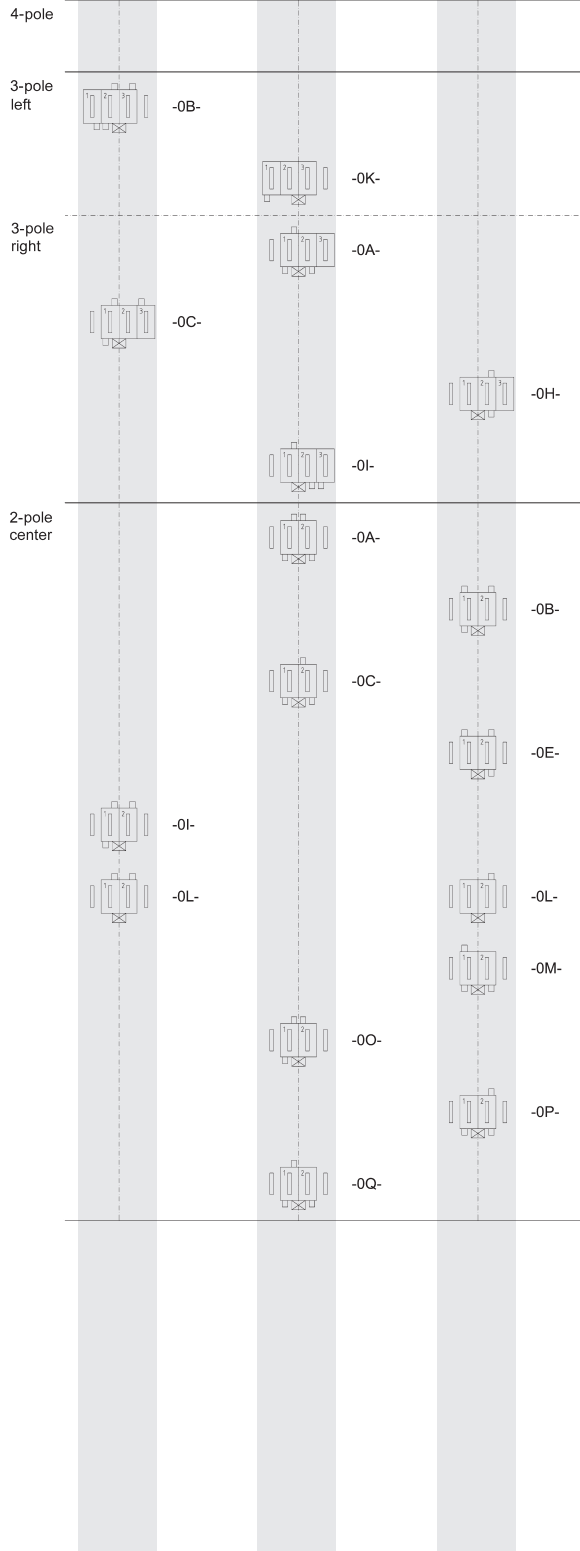

Selection of Contactor-Housings for Standard plugs acc. **System Stocko RAST 5**



Contactor
Housings

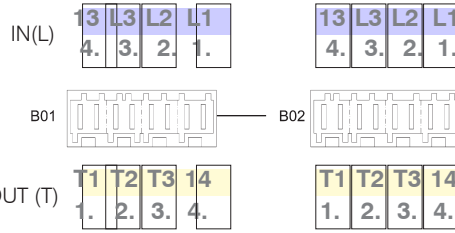

Code Contactor-Housings — **B01** — **B02** — **B03** — **B04** further housings on request ▶

Standard plugs
acc.
System Stocko RAST 5

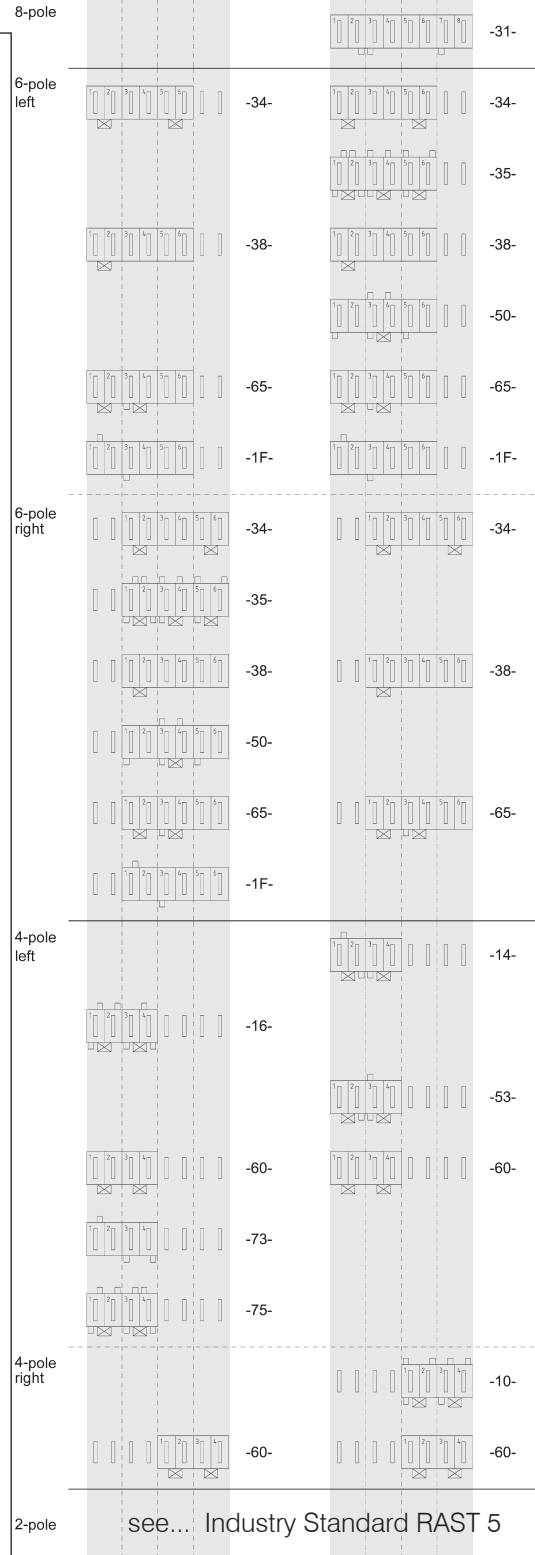

Order Example for
Contactors:

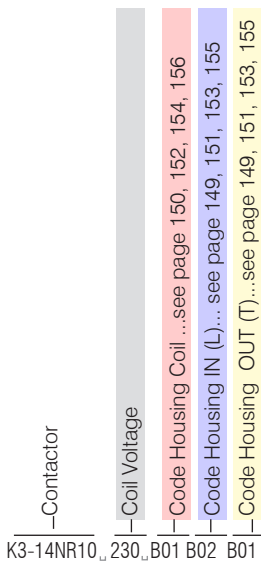

Selection of Coil-Housings for Standard plugs acc. **System Stocko RAST 5**



Coil-Housings –

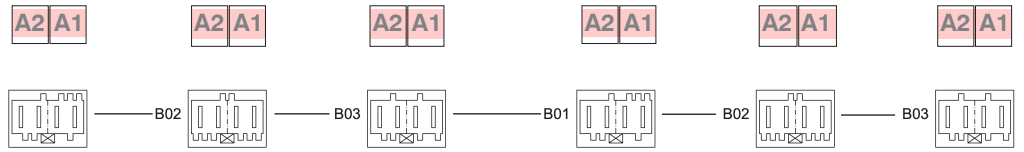

Code Coil-Housings	B01	B02	B03	B01	B02	B03
Standard plugs acc. System Stocko RAST 5	4-pole	-42-	-64-	3-pole right	-02-	-02-
		-78-	-78-		-04-	-03-
	-79-		-78-			-18-
			-79-			
3-pole left			-01-	-19-		
			-05-	-21-		
		-16-	-12-			-28-
			-30-	-47-	-52-	-52-
			-32-		-53-	
	-33-				-66-	-64-
	-36-		-35-			
		-40-		-71-		-73-
			-44-		-74-	
			-48-		-75-	
	-49-			2-pole center see... Industry Standard RAST 5		
	-51-					
	-72-	-72-	-72-			
		-75-	-75-			

Selection of Contactor-Housings for Standard plugs acc. **System Tyco RAST 5**



Contactor Housings

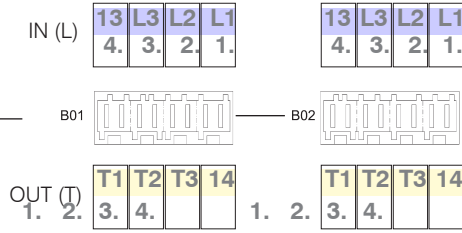

Code Contactor-Housings

B01 **B02** **B03** **B04** further housings on request ▶

Standard plugs acc. System Tyco RAST 5



8-pole	B01	B02	B03	B04
6-pole left		928151-6 2-928344-6		
6-pole right				
4-pole left	928344-4		4-928344-4	
4-pole right				
2-pole left		928344-2 3-964951-2 2-964951-2 928343-2		928344-2 964951-2 4-928344-2
2-pole center left	928344-2	3-964951-2 4-928344-2		
2-pole center right				2-928344-2 928343-2
2-pole right		2-928344-2 928343-2		2-964951-2 928343-2

Order Example for Contactors:









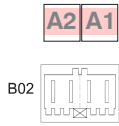

Contactor	Coil Voltage	Code Housing Coil ...see page 150, 152, 154, 156	Code Housing IN (L)... see page 149, 151, 153, 155	Code Housing OUT (T)...see page 149, 151, 153, 155
K3-14NR10	230	B01	B02	B01

Selection of Coil-Housings for Standard plugs acc. **System Tyco RAST 5**



Coil
Housings –



Code Coil-Housings	B01	B02	B03	B04	B05
4-pole					
3-pole left					
3-pole right		 928344-3			
2-pole center		 928344-2	 2-928344-2		
		 3-964951-2			
			 6-928344-2		
	 2-964951-2				
	 928343-2				
		 964951-2			
		 4-928344-2			
			 928343-2		

Standard plugs
acc.
System Lumberg RAST 5



Selection of Contactor-Housings for Standard plugs acc. **System Lumberg RAST 5**

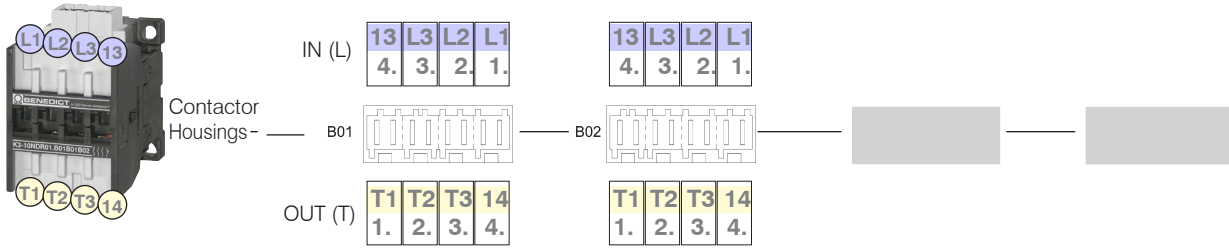

Code Contactor-Housings B01 B02 B03 B04 further housings on request

Standard plugs acc. System Lumberg RAST 5



	B01	B02	B03	B04
8-pole				
6-pole left				-10-
6-pole right				
4-pole left				-01-
4-pole right				-02-
2-pole left				-01- -03-
2-pole center left				-01- -03-
2-pole center right				-10- -02- -06-
2-pole right				-02- -06- -09-

Order Example for Contactors:

Contactor	K3-14NR10
Coil Voltage	230
Code Housing Coil ...see page 150, 152, 154, 156	B01
Code Housing IN (L)... see page 149, 151, 153, 155	B02
Code Housing OUT (T)...see page 149, 151, 153, 155	B01

Selection of Coil-Housings for Standard plugs acc. **System Lumberg RAST 5**

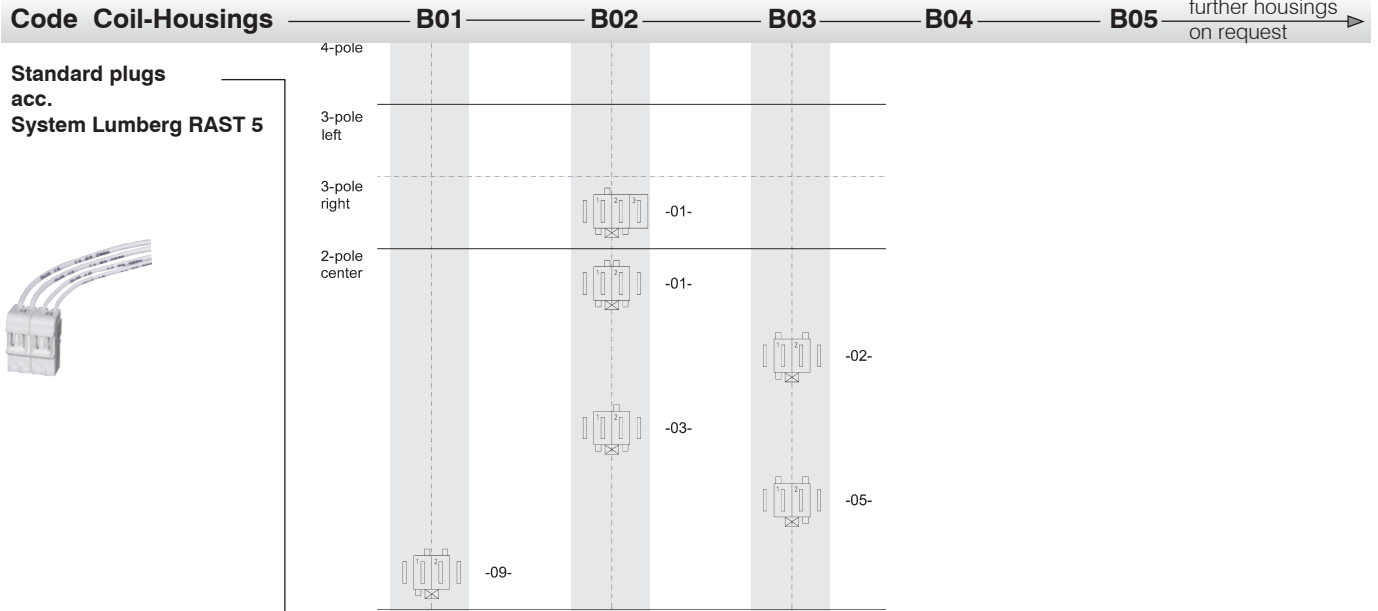
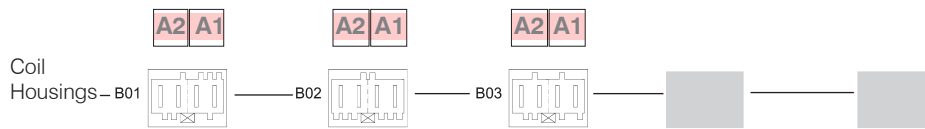

Selection of Auxiliary Contact Block-Housings for Standard plugs acc. **Industry Standard RAST 5**

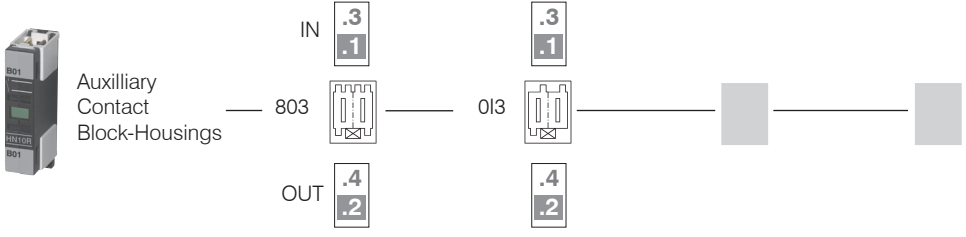

Code Auxilliary-Contact Block-Housings 803 013 further housings on request

Standard plugs acc. Industry Standard RAST 5

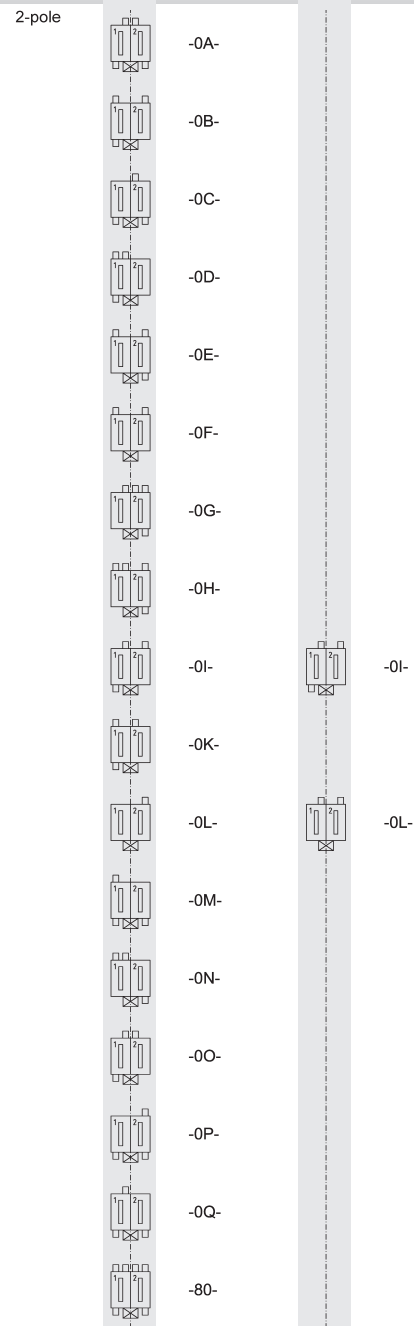

Order Example for Aux. Contact Blocks:

- Auxilliary Contact Block
 - Code Aux. Block Housing IN (1,3)
 - Code Aux. Block Housing OUT (2,4)
- HN10R-803013

Selection of Auxiliary Contact Block-Housings for Standard plugs acc. **System Stocko RAST 5**

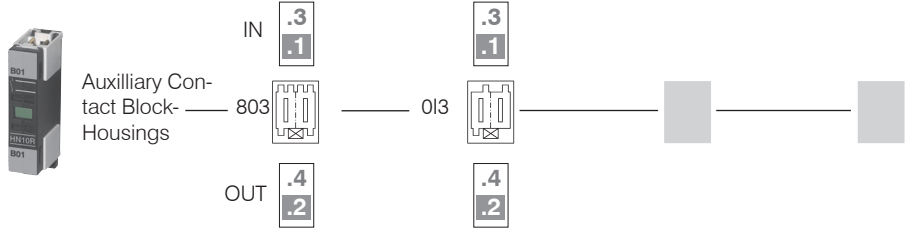

Code Auxiliary-Contact Block-Housings

Standard plugs acc. System Stocko RAST 5

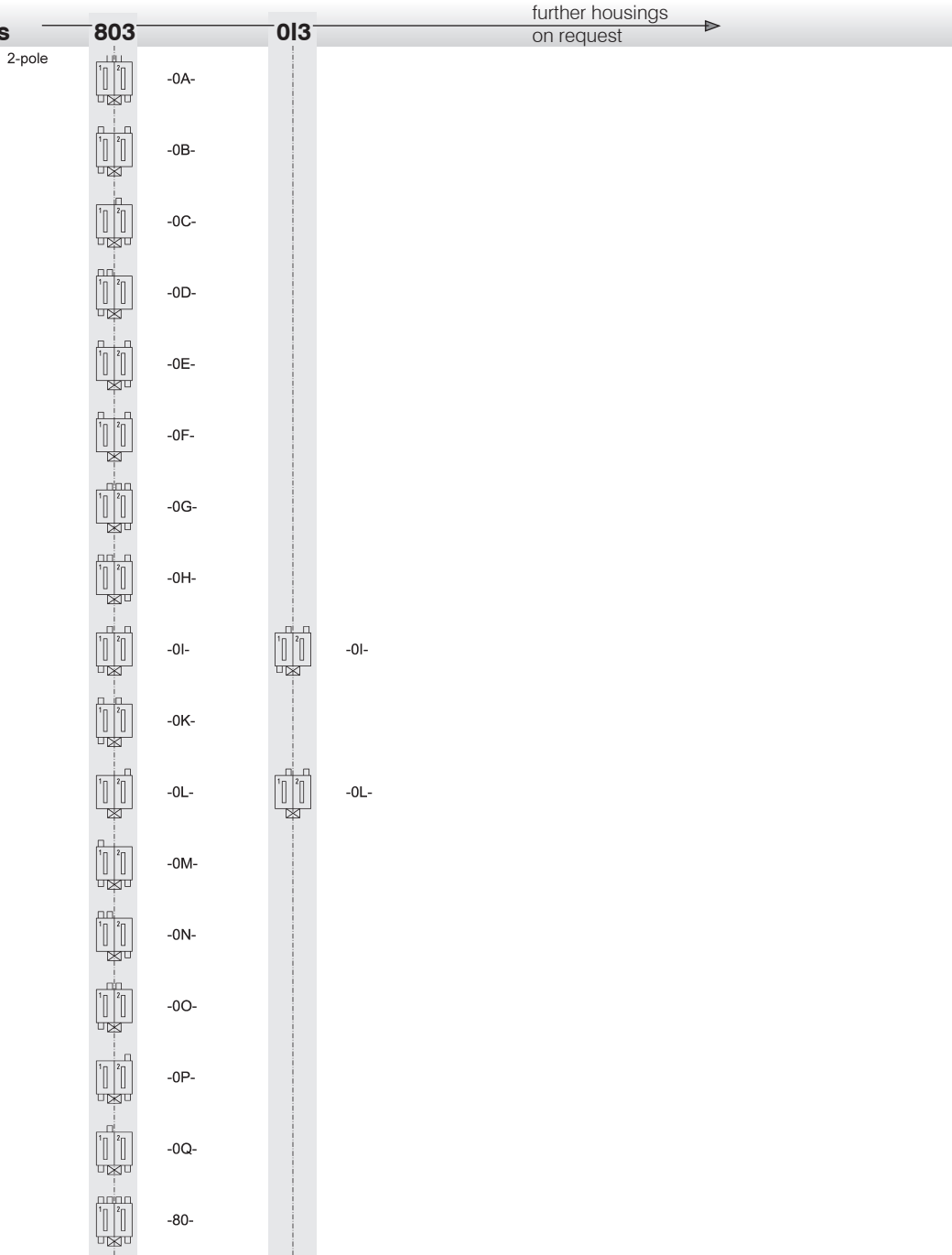

Order Example for Aux. Contact Blocks:

- Auxiliary Contact Block
- Code Aux. Block Housing IN (1,3)
- Code Aux. Block Housing OUT (2,4)

HN10R 803013

Selection of Auxiliary Contact Block-Housings for Standard plugs acc. **System Tyco RAST 5**

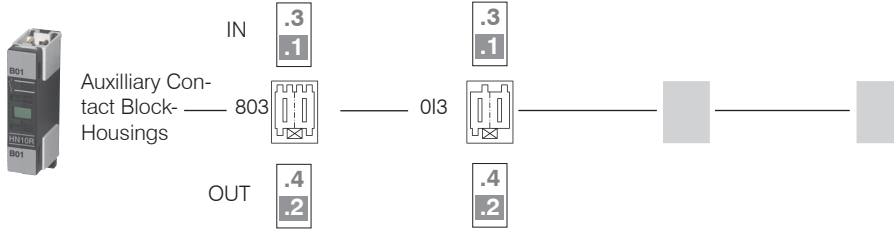

Code Auxilliary-Contact Block-Housings

803 **013** further housings on request →

Standard plugs acc. System Tyco RAST 5



2-pole	803	013
	928344-2	
	2-928344-2	
	3-964951-2	
	6-928344-2	
	5-928344-2	
	3-928344-2	
	2-964951-2	2-964951-2
	928343-2	928343-2
	964951-2	
	4-928344-2	

Order Example for Aux. Contact Blocks:

—Auxiliary Contact Block
 —Code Aux. Block Housing IN (**1**,**3**)
 —Code Aux. Block Housing OUT (**2**,**4**)
 HN10R-803013

- Contactor, Motor-Starter
- Circuit Breakers
- Manual Motor-Starters
- Switches
- AC-Main Switches
- DC-Switch Disconnect
- Push Buttons
- Representatives, Suppliers

Selection of Auxiliary Contact Block-Housings for Standard plugs acc. **System Lumberg RAST 5**

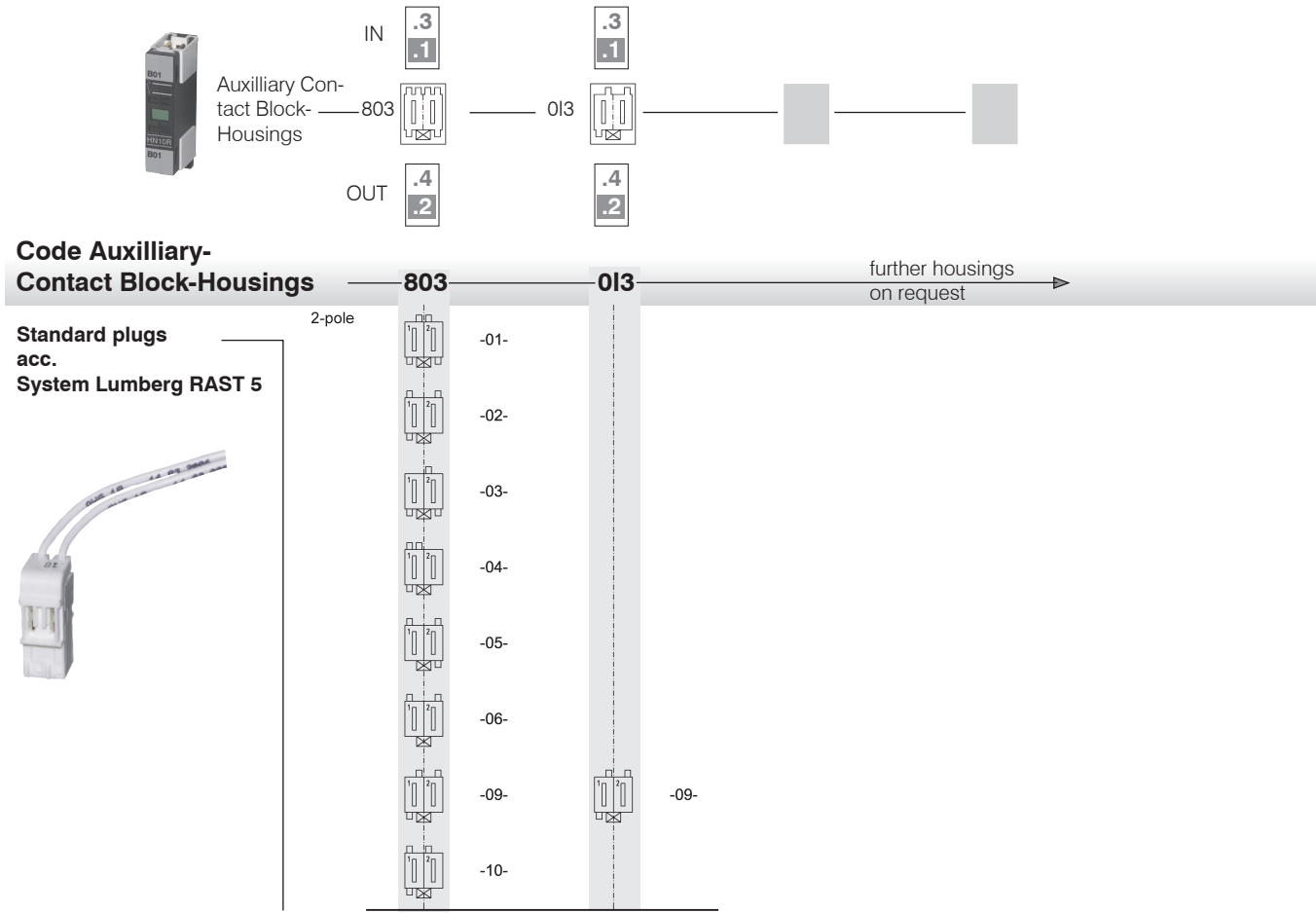

Order Example for
Aux. Contact Blocks:

- Auxiliary Contact Block
- Code Aux. Block Housing IN (1,3)
- Code Aux. Block Housing OUT (2,4)

HN10R 803013

Data acc. to IEC 60947-4-1, VDE 0660

Main Contacts		Type	K3-07NDR	K3-10NDR	K3-14NDR	K3-18NDR	K3-22NDR
Rated insulation voltage U_i ¹⁾		V~	415	415	415	415	415
Making capacity I_{eff}	at $U_e = 415V\sim$	A	-	200	200	200	200
Breaking capacity I_{eff}	at $U_e = 415V\sim$ $\cos\varphi = 0,65$	A	-	180	180	200	200
Utilization category AC1							
Switching of resistive load							
Rated operational current $I_e (=I_{th})$	415V	A	10	25	25	32	32
Rated operation power	220V	kW	-	9,5	9,5	12,2	12,2
of three-phase resistive loads	230V	kW	-	9,9	9,9	12,7	12,7
50-60Hz, $\cos\varphi = 1$	240V	kW	-	10,4	10,4	13,3	13,3
	380V	kW	-	16,4	16,4	21,0	21,0
	400V	kW	-	17,3	17,3	22,1	22,1
	415V	kW	-	17,9	17,9	23,0	23,0
Rated operational current $I_e (=I_{th})$	415V	A	6	25	25	32	32
at 60°C, enclosed	220V	kW	-	9,5	9,5	12,2	12,2
Rated operational power	230V	kW	-	9,9	9,9	12,7	12,7
of three-phase resistive loads	240V	kW	-	10,4	10,4	13,3	13,3
50-60Hz, $\cos\varphi = 1$	380V	kW	-	16,4	16,4	21,0	21,0
	400V	kW	-	17,3	17,3	22,1	22,1
	415V	kW	-	17,9	17,9	23,0	23,0
Minimum cross-section of conductor		mm ²	2 x 1,5 ²	2 x 1,5 ²	2 x 1,5 ²	2 x 2,5 ²	2 x 2,5 ²
at load with $I_e (=I_{th})$							
Utilization category AC2 and AC3							
Switching of three-phase motors							
Rated operational current I_e	220V	A	-	12	15	18	22
open and enclosed	230V	A	-	11,5	14,5	18	22
	240V	A	-	11	14	18	22
	380-400V	A	-	10	14	18	22
	415V	A	-	9	14	18	22
Rated operational power	220-230V	kW	-	3	4	5	6
of three-phase motors	240V	kW	-	3	4	5	7
50-60Hz	380-400V	kW	-	4	5,5	7,5	11
	415V	kW	-	4,5	6	8,5	12
Auxilliary Contacts							
Rated insulation voltage U_i		V~	415	415	415	415	415
Thermal rated current I_{th} up to 415V							
Ambient temperature	40°C	A	10	10	10	10	10
	60°C	A	6	6	6	6	6
Utilization category AC15							
Rated operational current I_e	220-240V	A	3	3	3	3	3
	380-415V	A	2	2	2	2	2
Utilization category DC13							
Rated operational current I_e	60V	A	3,5	3,5	3,5	3,5	3,5
	110V	A	0,5	0,5	0,5	0,5	0,5
	220V	A	0,1	0,1	0,1	0,1	0,1
Short circuit protection	gL (gG)	A	20	20	20	20	20

1) Suitable for: earthed -neutral systems, overvoltage category I to III, pollution degree 3 (Industry-Standard): $U_{imp} = 4kV$.
Data for other conditions on request.

Data acc. to IEC 60947-4-1, VDE 0660

Main Contacts		Type	K3-07NDR	K3-10NDR	K3-14NDR	K3-18NDR	K3-22NDR
Maximum ambient temperature							
Operation with thermal overload relay	open	°C	-40 up to +60 (+90) ¹⁾				
	enclosed	°C	-40 up to +40				
	open	°C	-25 up to +60				
	enclosed	°C	-25 up to +40				
Storage		°C	-50 up to +90				
Short circuit protection							
for contactors without thermal overload relay							
Coordination-Type „1“ acc. to IEC 947-4-1, Contact welding without hazard of persons							
max. fuse size	gL (gG)	A	20	63	63	63	63
Coordination-Type „2“ acc. to IEC 947-4-1, light Contact welding accepted							
max. fuse size	gL (gG)	A		25	35	35	35
Contact welding not accepted							
max. fuse size	gL (gG)	A		16	16	16	16
for Contactors with thermal overload relay the device with the smaller admissible backup fuse (contactor or thermal overload relay) determines the fuse size.							
Frequency of operations z							
Contactors without thermal overload relay							
	without load	1/h	10000	10000	10000	10000	10000
	AC3, I _e	1/h		600	600	600	600
	AC4, I _e	1/h		120	120	120	120
	DC3, I _e	1/h		600	600	600	600
Mechanical life							
AC-operated		S x 10 ⁶	10	10	10	10	10
DC-operated		S x 10 ⁶	10	10	10	10	10
Short time current	10sec.-current	A		96	120	144	176
Power loss per pole	at I _g /AC3 400V	W		0,21	0,35	0,5	0,75
Resistance to shock acc. to IEC 68-2-27							
Shock time 20ms sine-wave	NO	g				10	
	NC	g				6	
Control Circuit							
Power consumption of coils							
AC operated	inrush	VA				33-45	
	sealed	VA				7-10	
		W					2,6-3
DC operated	inrush	W				75	
	sealed	W				2	
Operating range of coils							
in multiples of control voltage U _s							
	AC operated					0,85-1,1	
	DC operated					0,8-1,1	
Switching time at control voltage U _s ± 10% ^{2) 3)}							
AC operated	make time	ms				8-16	
	release time	ms				5-13	
	arc duration	ms				10-15	
DC operated	make time	ms				8-12	
	release time	ms				8-13	
	arc duration	ms				10-15	

1) With reduced control voltage range 0,9 bis 1,0 x U_s and with reduced rated current I_g/AC1 acc. to I_g/AC3

2) Total breaking time = release time + arc duration

3) Values for delay of the release time of the make contact and the make time of the break contact will be increased, if magnet coils are protected with coil suppressor (Varistor, RC-Unit, Diode-Unit).

Data acc. to UL508

Main Contacts (cULus)		Type	K3-10NDR	K3-14NDR	K3-18NDR	K3-22NDR
Bemessungsbetriebsstrom „General Use“		A	25	25	30	30
Motor DOL 3-phase at 60Hz						
Rated operational current	415V	A	10	14	18	22
Rated operational power	110-120V	hp	1½	2	2	3
	200-208V	hp	3	3	5	5
	220-240V	hp	3	3	5	5
	265-277V	hp	3	5	7½	7½
	380-415V	hp	5	5	10	10
Motor DOL 1-phase at 60Hz						
Rated operational current	415V	A	10	14	18	22
Rated operational power of AC motor at 60Hz (1ph)	110-120V	hp	½	¾	1	1½
	200-208V	hp	1	1½	2	3
	220-240V	hp	1½	2	3	3
	265-277V	hp	2	3	3	3
	380-415V	hp	3	3	5	5
Fuses Suitable for use on a capability of delivering not more than (SCCR)		A	30	40	50	50
rms		A	5000	5000	5000	5000
		V	415	415	415	415
Auxilliary Contacts (cULus)			A300	A300	A300	A300

Accessories

Data acc. to IEC 60947-5-1, VDE 0660

Auxilliary Contacts		Type	HN10R	HN01R	
Rated insulation voltage U_i		V~	415	415	
Thermal rated current I_{th} up to 415V Ambient temperature	max. 40°C	A	10	10	
	max. 60°C	A	6	6	
Frequency of operations z		1/h	3000	3000	
Mechanical life		S x 10 ⁶	10	10	
Power loss per pole at $I_e/AC1$		W	0,5	0,5	
Utilization category AC15					
Rated operational betriebsstrom I_e	220-240V	A	3	3	
	380-415V	A	2	2	
Utilization category DC13					
Bemessungs- current I_e	60V	A	2	2	
	110V	A	0,4	0,4	
	220V	A	0,1	0,1	
Short circuit protection short circuit current 1kA, contact welding not accepted max. fuse size		gL (gG)	A	20	20

Data acc. to UL508

Rated operational current „General Use“		A	10	10
Rated operational voltage	max.	V~	300	300
Auxiliary Contacts			A300	A300

Dimensions

K3-..NDR.. +HN..R

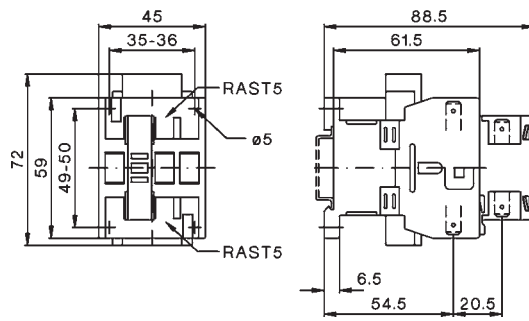

K3-..NDR.....PZ + U3/32..

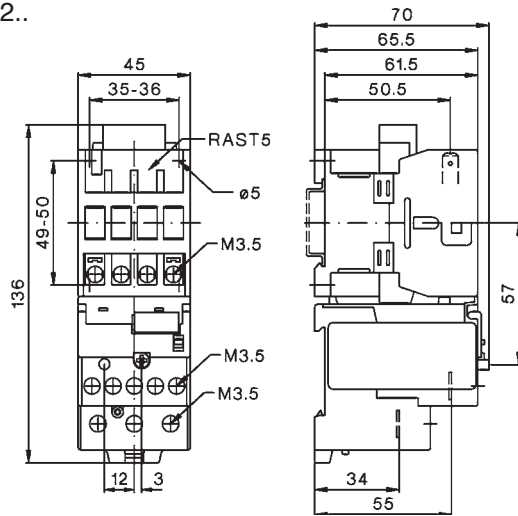

K3-..NDR.....PZ + U12/16E..K3

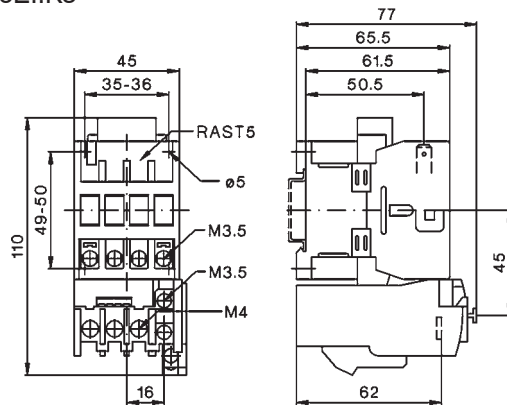

Technical data are subject to change without notice