

**Index**

Page



ON-OFF Switches for Panel Mounting

306



ON-OFF Switches for Single Hole Mounting

307



ON-OFF Switches for Base Mounting with Door Clutch

308



ON-OFF Switches for Distribution Boards

309



Main Switches for Panel Mounting

310



Main Switches for Single Hole Mounting

311



Main Switches for Base Mounting with Door Clutch

312



Main Switches for Distribution Boards

313



Main Switches in Plastic Enclosure

314



Technical Datas  
Approvals

315

319

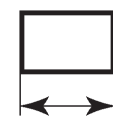

Dimensions

325

Contactor, Motor-Starter

Circuit Breakers

Manual Motor-Starters

Switches

AC-Main Switches

DC-Switch Disconnect

Push Buttons

Representatives, Suppliers

Ratings			DC-Switch Disconnectors				
Type	Rated current		Design	Panel mounting 4-hole mounting IP66 <sup>1)</sup> Type 3R	Single hole mounting Ø22,5mm IP66 <sup>1)</sup> Type 4X	Base mounting w. door coupling IP66 <sup>1)</sup> Type 4X	Modular switch IP40 <sup>1)</sup> Open Type
	$I_{th}$ open A	DC21B(DC-PV1) 4 poles in series A					
LS16	16	16	1500	.. E ..	.. Z(O) ..	.. VZV ..	.. SMA ..
LS25	25	25	1500	.. E ..	.. Z(O) ..	.. VZV ..	.. SMA ..
LS32	32	32	1500	.. E ..	.. Z(O) ..	.. VZV ..	.. SMA ..
LS38	38	38	1500	.. E ..	.. Z(O) ..	.. VZV ..	.. SMA ..
LS40	40	40	1500	.. E ..	-	.. VZV ..	.. SMA ..
LS55	55	55	1500	.. E ..	-	.. VZV ..	.. SMA ..

## Switch Disconnectors for Photovoltaic

Switch disconnectors „LS..“ are switch gears for interrupting the DC/AC-Inverter from the solar-panels. Photovoltaic-installations have to be equipped with DC-isolators according to IEC 60364-7-712.

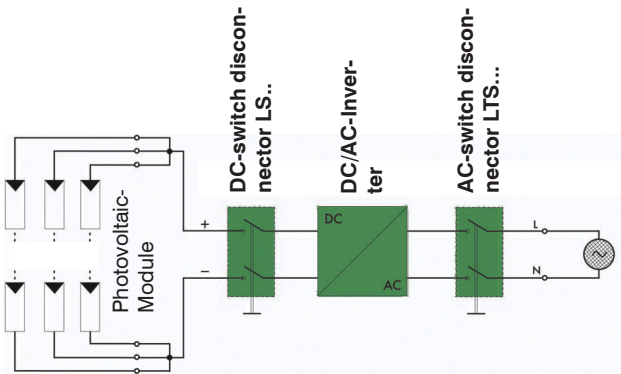

Switch disconnectors „LS..“ ensures a reliable switching up to 85A with 1500V in the category DC21B (DC-PV1).

The construction of the contacts and the material selection guarantee that no oxidation (small switching frequency) develops, and is thus prevented inadmissible heating-up.

The switch disconnector has 2, 4, 6 or 8 contacts, by serial or parallel wiring of the contacts the contact rating will be increased.

The switching speed at the manually operated handle does not have an effect on the switching attitude of the contacts.

## Switching programs

Type	2-pole	2+2-pole 2 poles in series +2 poles parallel	4-pole	4-pole with jumpers Input on top Output bottom	4-pole with jumpers Input and Output bottom	4-pole with jumpers Input and Output on top
LS16 ... LS55	.. A2	.. A2+2	..A4(2 x A2)	.. A4B	.. A4O	.. A4U
Contacts Wiring diagram						
Switching example						

## Ordering

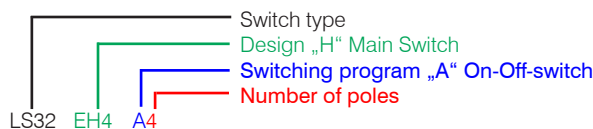

1) Protection in front and built in.

## DC-Main Switch

Panel mounting  
Four-hole mounting  
IP66<sup>1)</sup> Type 3R



Single hole mounting  
Ø22,5mm IP66<sup>1)</sup>  
Type 4X



Base mounting  
with door coupling  
IP66<sup>1)</sup> Type 4X



Modular  
switch IP40<sup>1)</sup>  
Open Type



Plastic enclosed  
PFL..IP66/67 Type 4X



.. EH4. ..	.. Z(O)H1 ..	.. VZVH4 ..	.. SMAH1 ..	.. PFLH4 ..
.. EH4. ..	.. Z(O)H1 ..	.. VZVH4 ..	.. SMAH1 ..	.. PFLH4 ..
.. EH4. ..	.. Z(O)H1 ..	.. VZVH4 ..	.. SMAH1 ..	.. PFLH4 ..
.. EH4. ..	.. Z(O)H1 ..	.. VZVH4 ..	.. SMAH1 ..	.. PFLH4 ..
.. EH4. ..	-	.. VZVH4 ..	.. SMAH1 ..	.. PFLH4 ..
.. EH4. ..	-	.. VZVH4 ..	.. SMAH1 ..	.. PFLH4 ..

### Technical data for DC, according to IEC 60947-3, VDE0660, more data see page 315

Typ		DC21B (DC-PV1)							DC22B				
		500V	600V	700V	800V	900V	1000V	1200V	1500V	500V	600V	800V	1000V
2 poles in series 	<b>LS16..</b> A	16	16	16	16	16	10	7	3	7	5,5	2	1
	<b>LS25..</b> A	25	25	25	20	17	11,5	8,5	5	8	6	2,5	1,5
	<b>LS32..</b> A	32	32	32	23	20	13	10	6	9	6,5	3	2
	<b>LS38..</b> A	45	45	-	30	-	20	-	-	-	-	-	-
	<b>LS40..</b> A	48	48	37	35	31	29	11	7,5	-	-	-	-
	<b>LS55..</b> A	55	55	55	55	43	36	17	10	-	-	-	-
2 poles in series+2 parallel 	<b>LS16..</b> A	29	29	22	17	16	10	7	3	-	-	-	-
	<b>LS25..</b> A	45	36	27	19	17	11,5	8,5	5	-	-	-	-
	<b>LS32..</b> A	58	55	32	23	20	13	10	6	-	-	-	-
	<b>LS38..</b> A	-	-	-	30	-	20	-	-	-	-	-	-
	<b>LS40..</b> A	72	68	49	42	31	29	11	7,5	-	-	-	-
	<b>LS55..</b> A	85	85	77	63	43	36	17	10	-	-	-	-
4 poles in series 	<b>LS16..</b> A	16	16	16	16	16	16	16	16	16	16	11,5	8
	<b>LS25..</b> A	25	25	25	25	25	25	25	25	25	25	12	9
	<b>LS32..</b> A	32	32	32	32	32	32	32	32	32	32	12,5	10
	<b>LS38..</b> A	45	45	-	-	-	-	-	-	-	-	-	-
	<b>LS40..</b> A	48	48	40	40	40	40	40	40	-	-	-	-
	<b>LS55..</b> A	55	55	55	55	55	55	55	55	-	-	-	-
4 poles in series+2 parallel 	<b>LS16..</b> A	29	29	29	29	29	29	29	20	-	-	-	-
	<b>LS25..</b> A	45	45	45	45	45	45	45	26	-	-	-	-
	<b>LS32..</b> A	58	58	58	58	58	58	50	32	-	-	-	-
	<b>LS38..</b> A	-	-	-	-	-	-	-	-	-	-	-	-
	<b>LS40..</b> A	72	72	72	72	72	72	56	42	-	-	-	-
	<b>LS55..</b> A	85	85	85	85	85	85	65	55	-	-	-	-













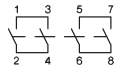

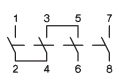

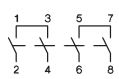
Type	6-pole	3+2-pole 3 poles in series +2 poles parallel	8-pole	4+2-pole 4 poles in series +2 poles parallel
<b>LS16 ... LS55</b>	...A6	.. A3+2	...A8	.. A4+2
Contacts Wiring diagram				
Switching example				

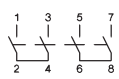
**Insulated Jumper LSV..** for series and parallel switching of contacts

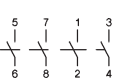
Type	Pack	Weight
<b>LS16, LS25, LS32, LS38</b> LSV-B1-1 <sup>1)</sup>	100	4,60 g/pc.
<b>LS16, LS25, LS32, LS38</b> LSV-B1-2 <sup>1)</sup>	100	8,00 g/pc.
<b>LS40, LS55</b> LSV-B2-1 <sup>1)</sup>	100	6,60 g/pc.
<b>LS40, LS55</b> LSV-B2-2 <sup>1)</sup>	100	11,00 g/pc.

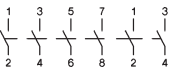
1) Range and Details see page 329.

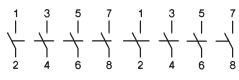
# ON-OFF Switches for Panel Mounting, Escutcheon plate 64', IP66 Type 3R

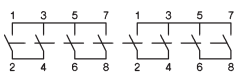
	DC21B / DC-PV1		Poles in series	Number of Strings	Type	Pack pcs	Weight kg/pcs.		
	600V DC	1000V DC							
			2	1	<b>LS16 E A2</b>	1	0,20		
			25A	11,5A	2	1	<b>LS25 E A2</b>	1	0,20
			32A	13A	2	1	<b>LS32 E A2</b>	1	0,20
			45A	20A	2	1	<b>LS38 E A2</b>	1	0,20
			48A	29A	2	1	<b>LS40 E A2</b>	1	0,41
			55A	36A	2	1	<b>LS55 E A2</b>	1	0,41
			2	1	<b>LS16 E A2+2</b>	1	0,25		
			36A	11,5A	2	1	<b>LS25 E A2+2</b>	1	0,25
			55A	13A	2	1	<b>LS32 E A2+2</b>	1	0,25
			-	20A	2	1	<b>LS38 E A2+2</b>	1	0,25
			68A	29A	2	1	<b>LS40 E A2+2</b>	1	0,54
			85A	36A	2	1	<b>LS55 E A2+2</b>	1	0,54
			2	2	<b>LS16 E A4</b>	1	0,23		
			25A	11,5A	2	2	<b>LS25 E A4</b>	1	0,23
			32A	13A	2	2	<b>LS32 E A4</b>	1	0,23
			45A	20A	2	2	<b>LS38 E A4</b>	1	0,23
			48A	29A	2	2	<b>LS40 E A4</b>	1	0,49
			55A	36A	2	2	<b>LS55 E A4</b>	1	0,49
			4	1	<b>LS16 E A4B</b>	1	0,24		
			25A	25A	4	1	<b>LS25 E A4B</b>	1	0,24
			32A	32A	4	1	<b>LS32 E A4B</b>	1	0,24
			45A	-	4	1	<b>LS38 E A4B</b>	1	0,24
			48A	40A	4	1	<b>LS40 E A4B</b>	1	0,52
			55A	55A	4	1	<b>LS55 E A4B</b>	1	0,52
			4	1	<b>LS16 E A4O</b>	1	0,24		
			25A	25A	4	1	<b>LS25 E A4O</b>	1	0,24
			32A	32A	4	1	<b>LS32 E A4O</b>	1	0,24
			45A	-	4	1	<b>LS38 E A4O</b>	1	0,24
			48A	40A	4	1	<b>LS40 E A4O</b>	1	0,52
			55A	55A	4	1	<b>LS55 E A4O</b>	1	0,52
			4	1	<b>LS16 E A4U</b>	1	0,24		
			25A	25A	4	1	<b>LS25 E A4U</b>	1	0,24
			32A	32A	4	1	<b>LS32 E A4U</b>	1	0,24
			45A	-	4	1	<b>LS38 E A4U</b>	1	0,24
			48A	40A	4	1	<b>LS40 E A4U</b>	1	0,52
			55A	55A	4	1	<b>LS55 E A4U</b>	1	0,52
			2	3	<b>LS16 E A6</b>	1	0,36		
			25A	11,5A	2	3	<b>LS25 E A6</b>	1	0,36
			32A	13A	2	3	<b>LS32 E A6</b>	1	0,36
			45A	20A	2	3	<b>LS38 E A6</b>	1	0,36
			48A	29A	2	3	<b>LS40 E A6</b>	1	0,99
			55A	36A	2	3	<b>LS55 E A6</b>	1	0,99
			2	4	<b>LS16 E A8</b>	1	0,41		
			25A	11,5A	2	4	<b>LS25 E A8</b>	1	0,41
			32A	13A	2	4	<b>LS32 E A8</b>	1	0,41
			45A	20A	2	4	<b>LS38 E A8</b>	1	0,41
			48A	29A	2	4	<b>LS40 E A8</b>	1	1,09
			55A	36A	2	4	<b>LS55 E A8</b>	1	1,09
			4	1	<b>LS16 E A4+2</b>	1	0,46		
			45A	45A	4	1	<b>LS25 E A4+2</b>	1	0,46
			58A	58A	4	1	<b>LS32 E A4+2</b>	1	0,46
			-	-	4	1	<b>LS38 E A4+2</b>	1	0,46
			72A	72A	4	1	<b>LS40 E A4+2</b>	1	1,20
			85A	85A	4	1	<b>LS55 E A4+2</b>	1	1,20







## Extended Switch Shaft for all switches for panel mounting

type suffix

+VW"x"

x = panel thickness

# ON-OFF Switches for Single Hole Mounting Ø22mm, Escutcheon plate 48°, IP66 Type 4X

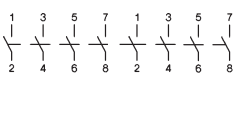
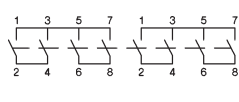
	DC21B / DC-PV1 600V DC	DC 1000V DC	Poles in series	Number of Strings	Type	Pack pcs	Weight kg/pcs.
							
							
							
							
							
							
							
							

# ON-OFF Switches for Single Hole Mounting Ø22mm, without Escutcheon plate, IP66, Typ 4X

	Replace the Type „Z“ with „ZO“				LS.. ZO A.		
---	--------------------------------	--	--	--	------------	--	--

# ON-OFF Switches f. Base Mounting w. Door Clutch f. Single Hole, Plate 64', IP66, Type 4X





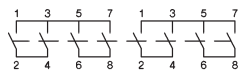
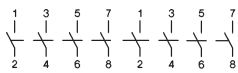
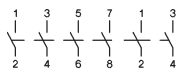
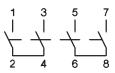
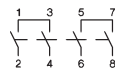
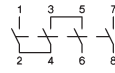
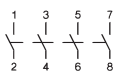
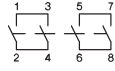

Depth is adjustable

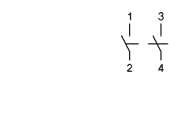

DC21B / DC-PV1 600V DC	1000V DC	Poles in series	Number of Strings	Type	Pack pcs	Weight kg/pcs.
16A	10A	2	1	<b>LS16 VZV A2</b>	1	0,22
25A	11,5A	2	1	<b>LS25 VZV A2</b>	1	0,22
32A	13A	2	1	<b>LS32 VZV A2</b>	1	0,22
45A	20A	2	1	<b>LS38 VZV A2</b>	1	0,22
48A	29A	2	1	<b>LS40 VZV A2</b>	1	0,51
55A	36A	2	1	<b>LS55 VZV A2</b>	1	0,51
29A	10A	2	1	<b>LS16 VZV A2+2</b>	1	0,27
36A	11,5A	2	1	<b>LS25 VZV A2+2</b>	1	0,27
55A	13A	2	1	<b>LS32 VZV A2+2</b>	1	0,27
-	20A	2	1	<b>LS38 VZV A2+2</b>	1	0,27
68A	29A	2	1	<b>LS40 VZV A2+2</b>	1	0,55
85A	36A	2	1	<b>LS55 VZV A2+2</b>	1	0,55
16A	10A	2	2	<b>LS16 VZV A4</b>	1	0,25
25A	11,5A	2	2	<b>LS25 VZV A4</b>	1	0,25
32A	13A	2	2	<b>LS32 VZV A4</b>	1	0,25
45A	13A	2	2	<b>LS38 VZV A4</b>	1	0,25
48A	29A	2	2	<b>LS40 VZV A4</b>	1	0,56
55A	36A	2	2	<b>LS55 VZV A4</b>	1	0,56
16A	16A	4	1	<b>LS16 VZV A4B</b>	1	0,26
25A	25A	4	1	<b>LS25 VZV A4B</b>	1	0,26
32A	32A	4	1	<b>LS32 VZV A4B</b>	1	0,26
45A	-	4	1	<b>LS38 VZV A4B</b>	1	0,26
48A	40A	4	1	<b>LS40 VZV A4B</b>	1	0,58
55A	55A	4	1	<b>LS55 VZV A4B</b>	1	0,58
16A	16A	4	1	<b>LS16 VZV A4O</b>	1	0,26
25A	25A	4	1	<b>LS25 VZV A4O</b>	1	0,26
32A	32A	4	1	<b>LS32 VZV A4O</b>	1	0,26
45A	-	4	1	<b>LS38 VZV A4O</b>	1	0,26
48A	40A	4	1	<b>LS40 VZV A4O</b>	1	0,58
55A	55A	4	1	<b>LS55 VZV A4O</b>	1	0,58
16A	16A	4	1	<b>LS16 VZV A4U</b>	1	0,26
25A	25A	4	1	<b>LS25 VZV A4U</b>	1	0,26
32A	32A	4	1	<b>LS32 VZV A4U</b>	1	0,26
45A	-	4	1	<b>LS38 VZV A4U</b>	1	0,26
48A	40A	4	1	<b>LS40 VZV A4U</b>	1	0,58
55A	55A	4	1	<b>LS55 VZV A4U</b>	1	0,58
16A	10A	2	3	<b>LS16 VZV A6</b>	1	0,38
25A	11,5A	2	3	<b>LS25 VZV A6</b>	1	0,38
32A	13A	2	3	<b>LS32 VZV A6</b>	1	0,38
45A	20A	2	3	<b>LS38 VZV A6</b>	1	0,38
48A	29A	2	3	<b>LS40 VZV A6</b>	1	1,00
55A	36A	2	3	<b>LS55 VZV A6</b>	1	1,00
16A	10A	2	4	<b>LS16 VZV A8</b>	1	0,43
25A	11,5A	2	4	<b>LS25 VZV A8</b>	1	0,43
32A	13A	2	4	<b>LS32 VZV A8</b>	1	0,43
45A	20A	2	4	<b>LS38 VZV A8</b>	1	0,43
48A	29A	2	4	<b>LS40 VZV A8</b>	1	1,10
55A	36A	2	4	<b>LS55 VZV A8</b>	1	1,10
29A	29A	4	1	<b>LS16 VZV A4+2</b>	1	0,48
45A	45A	4	1	<b>LS25 VZV A4+2</b>	1	0,48
58A	58A	4	1	<b>LS32 VZV A4+2</b>	1	0,48
-	-	4	1	<b>LS38 VZV A4+2</b>	1	0,48
72A	72A	4	1	<b>LS40 VZV A4+2</b>	1	1,21
85A	85A	4	1	<b>LS55 VZV A4+2</b>	1	1,21

# ON-OFF Switches for Distribution Boards, IP40, Open Type

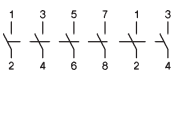
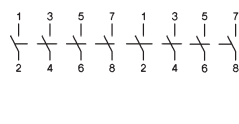
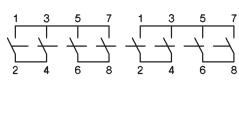
	DC21B / DC-PV1		Poles in series	Number of Strings	Type	Pack pcs	Weight kg/pcs.
	600V DC	1000V DC					
			2	1	<b>LS16 SMA A2</b>	1	0,19
			2	1	<b>LS25 SMA A2</b>	1	0,19
			2	1	<b>LS32 SMA A2</b>	1	0,19
			2	1	<b>LS38 SMA A2</b>	1	0,19
			2	1	<b>LS40 SMA A2</b>	1	0,41
		2	1	<b>LS55 SMA A2</b>	1	0,41	
			2	1	<b>LS16 SMA A2+2</b>	1	0,24
			2	1	<b>LS25 SMA A2+2</b>	1	0,24
			2	1	<b>LS32 SMA A2+2</b>	1	0,24
			2	1	<b>LS38 SMA A2+2</b>	1	0,24
			2	1	<b>LS40 SMA A2+2</b>	1	0,52
		2	1	<b>LS55 SMA A2+2</b>	1	0,52	
			2	2	<b>LS16 SMA A4</b>	1	0,22
			2	2	<b>LS25 SMA A4</b>	1	0,22
			2	2	<b>LS32 SMA A4</b>	1	0,22
			2	2	<b>LS38 SMA A4</b>	1	0,22
			2	2	<b>LS40 SMA A4</b>	1	0,45
		2	2	<b>LS55 SMA A4</b>	1	0,45	
			4	1	<b>LS16 SMA A4B</b>	1	0,23
			4	1	<b>LS25 SMA A4B</b>	1	0,23
			4	1	<b>LS32 SMA A4B</b>	1	0,23
			4	1	<b>LS38 SMA A4B</b>	1	0,23
			4	1	<b>LS40 SMA A4B</b>	1	0,49
		4	1	<b>LS55 SMA A4B</b>	1	0,49	
			4	1	<b>LS16 SMA A4O</b>	1	0,23
			4	1	<b>LS25 SMA A4O</b>	1	0,23
			4	1	<b>LS32 SMA A4O</b>	1	0,23
			4	1	<b>LS38 SMA A4O</b>	1	0,23
			4	1	<b>LS40 SMA A4O</b>	1	0,49
		4	1	<b>LS55 SMA A4O</b>	1	0,49	
			4	1	<b>LS16 SMA A4U</b>	1	0,23
			4	1	<b>LS25 SMA A4U</b>	1	0,23
			4	1	<b>LS32 SMA A4U</b>	1	0,23
			4	1	<b>LS38 SMA A4U</b>	1	0,23
			4	1	<b>LS40 SMA A4U</b>	1	0,49
		4	1	<b>LS55 SMA A4U</b>	1	0,49	
			2	3	<b>LS16 SMA A6</b>	1	0,35
			2	3	<b>LS25 SMA A6</b>	1	0,35
			2	3	<b>LS32 SMA A6</b>	1	0,35
			2	3	<b>LS38 SMA A6</b>	1	0,35
			2	3	<b>LS40 SMA A6</b>	1	0,89
		2	3	<b>LS55 SMA A6</b>	1	0,89	
			2	4	<b>LS16 SMA A8</b>	1	0,40
			2	4	<b>LS25 SMA A8</b>	1	0,40
			2	4	<b>LS32 SMA A8</b>	1	0,40
			2	4	<b>LS38 SMA A8</b>	1	0,40
			2	4	<b>LS40 SMA A8</b>	1	0,99
		2	4	<b>LS55 SMA A8</b>	1	0,99	
			4	1	<b>LS16 SMA A4+2</b>	1	0,43
			4	1	<b>LS25 SMA A4+2</b>	1	0,43
			4	1	<b>LS32 SMA A4+2</b>	1	0,43
			4	1	<b>LS38 SMA A4+2</b>	1	0,43
			4	1	<b>LS40 SMA A4+2</b>	1	1,01
		4	1	<b>LS55 SMA A4+2</b>	1	1,01	

Contactor, Motor-Starters

Circuit Breakers

Manual Motor-Starters

Switches

AC-Main Switches

DC-Switch Disconnectors

Push Buttons

Representatives, Suppliers

# Main Switches for Panel Mounting, Escutcheon plate 64<sup>r</sup>, IP66, Type 4X



padlock device SV4

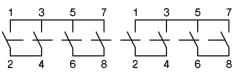
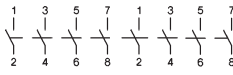
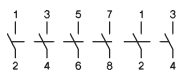
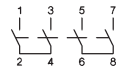
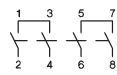
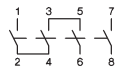
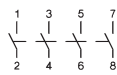
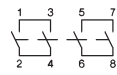

DC21B / DC-PV1 600V DC	1000V DC	Poles in series	Number of Strings	Type	Pack pcs	Weight kg/pcs.
16A	10A	2	1	LS16 EH4 A2	1	0,21
25A	11,5A	2	1	LS25 EH4 A2	1	0,21
32A	13A	2	1	LS32 EH4 A2	1	0,21
45A	20A	2	1	LS38 EH4 A2	1	0,21
48A	29A	2	1	LS40 EH4 A2	1	0,43
55A	36A	2	1	LS55 EH4 A2	1	0,43
29A	10A	2	1	LS16 EH4 A2+2	1	0,26
36A	11,5A	2	1	LS25 EH4 A2+2	1	0,26
55A	13A	2	1	LS32 EH4 A2+2	1	0,26
-	20A	2	1	LS38 EH4 A2+2	1	0,26
68A	29A	2	1	LS40 EH4 A2+2	1	0,57
85A	36A	2	1	LS55 EH4 A2+2	1	0,57
16A	10A	2	2	LS16 EH4 A4	1	0,24
25A	11,5A	2	2	LS25 EH4 A4	1	0,24
32A	13A	2	2	LS32 EH4 A4	1	0,24
32A	20A	2	2	LS38 EH4 A4	1	0,24
40A	29A	2	2	LS40 EH4 A4	1	0,50
55A	36A	2	2	LS55 EH4 A4	1	0,50
16A	10A	4	1	LS16 EH4 A4B	1	0,25
25A	11,5A	4	1	LS25 EH4 A4B	1	0,25
32A	13A	4	1	LS32 EH4 A4B	1	0,25
45A	-	4	1	LS38 EH4 A4B	1	0,25
48A	29A	4	1	LS40 EH4 A4B	1	0,53
55A	36A	4	1	LS55 EH4 A4B	1	0,53
16A	16A	4	1	LS16 EH4 A4O	1	0,25
25A	25A	4	1	LS25 EH4 A4O	1	0,25
32A	32A	4	1	LS32 EH4 A4O	1	0,25
45A	-	4	1	LS38 EH4 A4O	1	0,25
48A	40A	4	1	LS40 EH4 A4O	1	0,53
55A	55A	4	1	LS55 EH4 A4O	1	0,53
16A	16A	4	1	LS16 EH4 A4U	1	0,25
25A	25A	4	1	LS25 EH4 A4U	1	0,25
32A	32A	4	1	LS32 EH4 A4U	1	0,25
45A	-	4	1	LS38 EH4 A4U	1	0,25
48A	40A	4	1	LS40 EH4 A4U	1	0,53
55A	55A	4	1	LS55 EH4 A4U	1	0,53
16A	10A	2	3	LS16 EH4 A6	1	0,37
25A	11,5A	2	3	LS25 EH4 A6	1	0,37
32A	13A	2	3	LS32 EH4 A6	1	0,37
45A	20A	2	3	LS32 EH4 A6	1	0,37
48A	29A	2	3	LS40 EH4 A6	1	0,53
55A	36A	2	3	LS55 EH4 A6	1	0,53
16A	10A	2	4	LS16 EH4 A8	1	0,42
25A	11,5A	2	4	LS25 EH4 A8	1	0,42
32A	13A	2	4	LS32 EH4 A8	1	0,42
45A	20A	2	4	LS38 EH4 A8	1	0,42
48A	29A	2	4	LS40 EH4 A8	1	1,10
55A	36A	2	4	LS55 EH4 A8	1	1,10
29A	29A	4	1	LS16 EH4 A4+2	1	0,47
45A	45A	4	1	LS25 EH4 A4+2	1	0,47
58A	58A	4	1	LS32 EH4 A4+2	1	0,47
-	-	4	1	LS38 EH4 A4+2	1	0,47
72A	72A	4	1	LS40 EH4 A4+2	1	1,21
85A	85A	4	1	LS55 EH4 A4+2	1	1,21

## Extended Switch Shaft for all switches for panel mounting





type suffix

+VW"x"

x = panel thickness

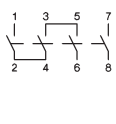
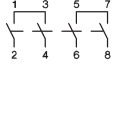
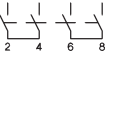

# Main Switches for Single Hole Mounting Ø22mm, Escutcheon plate 48', IP66, Type 4X

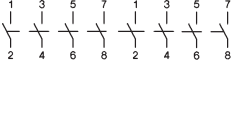
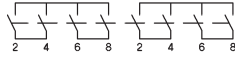
	DC21B / DC-PV1		Poles in series	Number of Strings	Type	Pack pcs	Weight kg/pcs.
	600V DC	1000V DC					
							
padlock device SV1							
							
							
							
							
							
							
							

# Main Switches, Single Hole Mounting Ø22mm, without Escutcheon plate, IP66, Type 4X

Replace the Type „ZH1“ with „ZOH1“ **LS.. ZOH1 A.**

# Main Switches f. Base Mounting, Door Clutch f. Single Hole, Escutcheon plate 64<sup>r</sup>, IP66,



DC21B / DC-PV1 600V DC	1000V DC	Poles in series	Number of Strings	Type	Pack pcs	Weight kg/pcs.
16A	10A	2	1	<b>LS16 VZVH4 A2</b>	1	0,23
25A	1,5A	2	1	<b>LS25 VZVH4 A2</b>	1	0,23
32A	13A	2	1	<b>LS32 VZVH4 A2</b>	1	0,23
45A	20A	2	1	<b>LS38 VZVH4 A2</b>	1	0,23
48A	29A	2	1	<b>LS40 VZVH4 A2</b>	1	0,51
55A	36A	2	1	<b>LS55 VZVH4 A2</b>	1	0,51

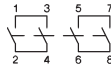

29A	10A	2	1	<b>LS16 VZVH4 A2+2</b>	1	0,28
36A	11,5A	2	1	<b>LS25 VZVH4 A2+2</b>	1	0,28
55A	13A	2	1	<b>LS32 VZVH4 A2+2</b>	1	0,28
-	20A	2	1	<b>LS38 VZVH4 A2+2</b>	1	0,28
68A	29A	2	1	<b>LS40 VZVH4 A2+2</b>	1	0,65
85A	36A	2	1	<b>LS55 VZVH4 A2+2</b>	1	0,65

Depth is adjustable  
see page 317  
padlock device SV4

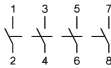

16A	10A	2	2	<b>LS16 VZVH4 A4</b>	1	0,26
25A	11,5A	2	2	<b>LS25 VZVH4 A4</b>	1	0,26
32A	13A	2	2	<b>LS32 VZVH4 A4</b>	1	0,26
45A	20A	2	2	<b>LS38 VZVH4 A4</b>	1	0,26
48A	29A	2	2	<b>LS40 VZVH4 A4</b>	1	0,58
55A	36A	2	2	<b>LS55 VZVH4 A4</b>	1	0,58

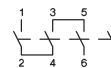

16A	16A	4	1	<b>LS16 VZVH4 A4B</b>	1	0,27
25A	25A	4	1	<b>LS25 VZVH4 A4B</b>	1	0,27
32A	32A	4	1	<b>LS32 VZVH4 A4B</b>	1	0,27
45A	-	4	1	<b>LS38 VZVH4 A4B</b>	1	0,27
48A	40A	4	1	<b>LS40 VZVH4 A4B</b>	1	0,62
55A	55A	4	1	<b>LS55 VZVH4 A4B</b>	1	0,62

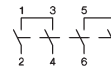

16A	16A	4	1	<b>LS16 VZVH4 A4O</b>	1	0,27
25A	25A	4	1	<b>LS25 VZVH4 A4O</b>	1	0,27
32A	32A	4	1	<b>LS32 VZVH4 A4O</b>	1	0,27
45A	-	4	1	<b>LS38 VZVH4 A4O</b>	1	0,27
48A	40A	4	1	<b>LS40 VZVH4 A4O</b>	1	0,62
55A	55A	4	1	<b>LS55 VZVH4 A4O</b>	1	0,62

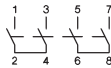

16A	16A	4	1	<b>LS16 VZVH4 A4U</b>	1	0,27
25A	25A	4	1	<b>LS25 VZVH4 A4U</b>	1	0,27
32A	32A	4	1	<b>LS32 VZVH4 A4U</b>	1	0,27
32A	-	4	1	<b>LS38 VZVH4 A4U</b>	1	0,27
40A	40A	4	1	<b>LS40 VZVH4 A4U</b>	1	0,62
55A	55A	4	1	<b>LS55 VZVH4 A4U</b>	1	0,62

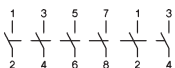

16A	10A	2	3	<b>LS16 VZVH4 A6</b>	1	0,39
25A	11,5A	2	3	<b>LS25 VZVH4 A6</b>	1	0,39
32A	13A	2	3	<b>LS32 VZVH4 A6</b>	1	0,39
45A	20A	2	3	<b>LS38 VZVH4 A6</b>	1	0,39
48A	29A	2	3	<b>LS40 VZVH4 A6</b>	1	1,00
55A	36A	2	3	<b>LS55 VZVH4 A6</b>	1	1,00

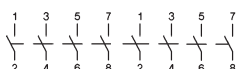



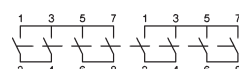



16A	10A	2	4	<b>LS16 VZVH4 A8</b>	1	0,44
25A	11,5A	2	4	<b>LS25 VZVH4 A8</b>	1	0,44
32A	13A	2	4	<b>LS32 VZVH4 A8</b>	1	0,44
45A	20A	2	4	<b>LS38 VZVH4 A8</b>	1	0,44
48A	29A	2	4	<b>LS40 VZVH4 A8</b>	1	1,11
55A	36A	2	4	<b>LS55 VZVH4 A8</b>	1	1,11



29A	29A	4	1	<b>LS16 VZVH4 A4+2</b>	1	0,49
45A	45A	4	1	<b>LS25 VZVH4 A4+2</b>	1	0,49
58A	58A	4	1	<b>LS32 VZVH4 A4+2</b>	1	0,49
-	-	4	1	<b>LS38 VZVH4 A4+2</b>	1	0,49
72A	72A	4	1	<b>LS40 VZVH4 A4+2</b>	1	1,22
85A	85A	4	1	<b>LS55 VZVH4 A4+2</b>	1	1,22

# Main Switches for Distribution Boards, IP40, Open Type

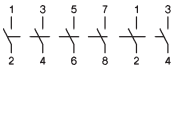
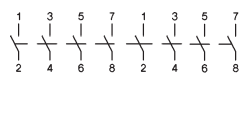
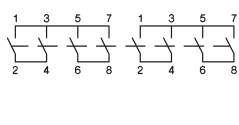
	DC21B / DC-PV1 600V DC	1000V DC	Poles in series	Number of Strings	Type	Pack pcs.	Weight kg/pcs.
	16A	10A	2	1	LS16 SMAH1 A2	1	0,19
	25A	11,5A	2	1	LS25 SMAH1 A2	1	0,19
	32A	13A	2	1	LS32 SMAH1 A2	1	0,19
	45A	20A	2	1	LS38 SMAH1 A2	1	0,19
	48A	29A	2	1	LS40 SMAH1 A2	1	0,40
	55A	36A	2	1	LS55 SMAH1 A2	1	0,40
padlock device SV1 	29A	10A	2	1	LS16 SMAH1 A2+2 <sup>1)</sup>	1	0,25
	36A	11,5A	2	1	LS25 SMAH1 A2+2 <sup>1)</sup>	1	0,25
	55A	13A	2	1	LS32 SMAH1 A2+2 <sup>1)</sup>	1	0,25
	-	20A	2	1	LS38 SMAH1 A2+2 <sup>1)</sup>	1	0,25
	68A	29A	2	1	LS40 SMAH1 A2+2	1	0,54
	85A	36A	2	1	LS55 SMAH1 A2+2	1	0,54
	16A	10A	2	2	LS16 SMAH1 A4 <sup>1)</sup>	1	0,22
	25A	11,5A	2	2	LS25 SMAH1 A4 <sup>1)</sup>	1	0,22
	32A	13A	2	2	LS32 SMAH1 A4 <sup>1)</sup>	1	0,22
	45A	20A	2	2	LS38 SMAH1 A4 <sup>1)</sup>	1	0,22
	48A	29A	2	2	LS40 SMAH1 A4	1	0,47
	55A	36A	2	2	LS55 SMAH1 A4	1	0,47
	16A	16A	4	1	LS16 SMAH1 A4B <sup>1)</sup>	1	0,23
	25A	25A	4	1	LS25 SMAH1 A4B <sup>1)</sup>	1	0,23
	32A	32A	4	1	LS32 SMAH1 A4B <sup>1)</sup>	1	0,23
	45A	-	4	1	LS38 SMAH1 A4B <sup>1)</sup>	1	0,23
	48A	40A	4	1	LS40 SMAH1 A4B	1	0,50
	55A	55A	4	1	LS55 SMAH1 A4B	1	0,50
	16A	16A	4	1	LS16 SMAH1 A4O <sup>1)</sup>	1	0,23
	25A	25A	4	1	LS25 SMAH1 A4O <sup>1)</sup>	1	0,23
	32A	32A	4	1	LS32 SMAH1 A4O <sup>1)</sup>	1	0,23
	45A	-	4	1	LS38 SMAH1 A4O <sup>1)</sup>	1	0,23
	48A	40A	4	1	LS40 SMAH1 A4O	1	0,50
	55A	55A	4	1	LS55 SMAH1 A4O	1	0,50
	16A	16A	4	1	LS16 SMAH1 A4U <sup>1)</sup>	1	0,23
	25A	25A	4	1	LS25 SMAH1 A4U <sup>1)</sup>	1	0,23
	32A	32A	4	1	LS32 SMAH1 A4U <sup>1)</sup>	1	0,23
	45A	-	4	1	LS38 SMAH1 A4U <sup>1)</sup>	1	0,23
	48A	40A	4	1	LS40 SMAH1 A4U	1	0,50
	55A	55A	4	1	LS55 SMAH1 A4U	1	0,50
	16A	10A	2	3	LS16 SMAH1 A6	1	0,36
	25A	11,5A	2	3	LS25 SMAH1 A6	1	0,36
	32A	13A	2	3	LS32 SMAH1 A6	1	0,36
	45A	20A	2	3	LS32 SMAH1 A6	1	0,36
	48A	29A	2	3	LS40 SMAH1 A6	1	0,90
	55A	36A	2	3	LS55 SMAH1 A6	1	0,90
	16A	10A	2	4	LS16 SMAH1 A8	1	0,41
	25A	11,5A	2	4	LS25 SMAH1 A8	1	0,41
	32A	13A	2	4	LS32 SMAH1 A8	1	0,41
	45A	20A	2	4	LS38 SMAH1 A8	1	0,41
	48A	29A	2	4	LS40 SMAH1 A8	1	0,41
	55A	36A	2	4	LS55 SMAH1 A8	1	0,41
	29A	29A	4	1	LS16 SMAH1 A4+2	1	0,46
	45A	45A	4	1	LS25 SMAH1 A4+2	1	0,46
	58A	58A	4	1	LS32 SMAH1 A4+2	1	0,46
	-	-	4	1	LS38 SMAH1 A4+2	1	0,46
	72A	72A	4	1	LS40 SMAH1 A4+2	1	1,12
	85A	85A	4	1	LS55 SMAH1 A4+2	1	1,12

<sup>1)</sup> Main Switches for Distribution Boards with low height handle, IP40,   Open Type

Type with Type-suffix „+SV1N“ e.g. **LS.. SMAH1 A2+2 +SV1N**

# Main Switches in Plastic Enclosure, Escutcheon plate 64<sup>r</sup>, IP66/67, Type 4X



padlock device SV4

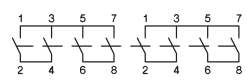
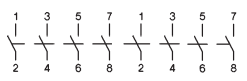
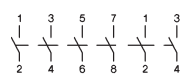
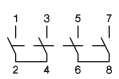
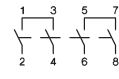
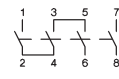
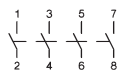
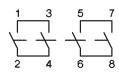

DC21B / DC-PV1 600V DC 1000V DC	Poles in series	Number of Strings	Type	Pack pcs	Weight kg/pcs.
16A 10A	2	1	LS16 PFLH4 A2	1	0,43
25A 11,5A	2	1	LS25 PFLH4 A2	1	0,43
32A 13A	2	1	LS32 PFLH4 A2	1	0,43
45A 20A	2	1	LS38 PFLH4 A2	1	0,43
48A 29A	2	1	LS40 PFLH4 A2 <sup>1)</sup>	1	1,59
55A 36A	2	1	LS55 PFLH4 A2 <sup>1)</sup>	1	1,59
29A 10A	2	1	LS16 PFLH4 A2+2	1	0,49
36A 11,5A	2	1	LS25 PFLH4 A2+2	1	0,49
55A 13A	2	1	LS32 PFLH4 A2+2	1	0,49
- 20A	2	1	LS38 PFLH4 A2+2	1	0,49
68A 29A	2	1	LS40 PFLH4 A2+2 <sup>1)</sup>	1	1,74
85A 36A	2	1	LS55 PFLH4 A2+2 <sup>1)</sup>	1	1,74
16A 10A	2	2	LS16 PFLH4 A4	1	0,46
25A 11,5A	2	2	LS25 PFLH4 A4	1	0,46
32A 13A	2	2	LS32 PFLH4 A4	1	0,46
45A 20A	2	2	LS38 PFLH4 A4	1	0,46
48A 29A	2	2	LS40 PFLH4 A4 <sup>1)</sup>	1	1,67
55A 36A	2	2	LS55 PFLH4 A4 <sup>1)</sup>	1	1,67
16A 16A	4	1	LS16 PFLH4 A4B	1	0,47
25A 25A	4	1	LS25 PFLH4 A4B	1	0,47
32A 32A	4	1	LS32 PFLH4 A4B	1	0,47
45A -	4	1	LS38 PFLH4 A4B	1	0,47
48A 40A	4	1	LS40 PFLH4 A4B <sup>1)</sup>	1	1,70
55A 55A	4	1	LS55 PFLH4 A4B <sup>1)</sup>	1	1,70
16A 16A	4	1	LS16 PFLH4 A4O	1	0,47
25A 25A	4	1	LS25 PFLH4 A4O	1	0,47
32A 32A	4	1	LS32 PFLH4 A4O	1	0,47
45A -	4	1	LS38 PFLH4 A4O	1	0,47
48A 40A	4	1	LS40 PFLH4 A4O <sup>1)</sup>	1	1,70
55A 55A	4	1	LS55 PFLH4 A4O <sup>1)</sup>	1	1,70
16A 16A	4	1	LS16 PFLH4 A4U	1	0,47
25A 25A	4	1	LS25 PFLH4 A4U	1	0,47
32A 32A	4	1	LS32 PFLH4 A4U	1	0,47
45A -	4	1	LS38 PFLH4 A4U	1	0,47
48A 40A	4	1	LS40 PFLH4 A4U <sup>1)</sup>	1	1,70
55A 55A	4	1	LS55 PFLH4 A4U <sup>1)</sup>	1	1,70
16A 10A	2	3	LS16 PFLH4 A6	1	1,53
25A 11,5A	2	3	LS25 PFLH4 A6	1	1,53
32A 13A	2	3	LS32 PFLH4 A6	1	1,53
45A 20A	2	3	LS38 PFLH4 A6	1	1,53
48A 29A	2	3	LS40 PFLH4 A6	1	1,87
55A 36A	2	3	LS55 PFLH4 A6	1	1,87
16A 10A	2	4	LS16 PFLH4 A8	1	1,58
25A 11,5A	2	4	LS25 PFLH4 A8	1	1,58
32A 13A	2	4	LS32 PFLH4 A8	1	1,58
45A 13A	2	4	LS38 PFLH4 A8	1	1,58
48A 29A	2	4	LS40 PFLH4 A8	1	1,94
55A 36A	2	4	LS55 PFLH4 A8	1	1,94
29A 29A	4	1	LS16 PFLH4 A4+2	1	1,63
45A 45A	4	1	LS25 PFLH4 A4+2	1	1,63
58A 58A	4	1	LS32 PFLH4 A4+2	1	1,63
-8A 58A	4	1	LS38 PFLH4 A4+2	1	1,63
72A 72A	4	1	LS40 PFLH4 A4+2	1	2,07
85A 85A	4	1	LS55 PFLH4 A4+2	1	2,07

<sup>1)</sup> **Small Enclosure:** Type with Type-suffix „+PF2“

e.g. **LS.. PFLH4 A2+2 +PF2** (Dimensions see page 329)

# Technical Data

Kind of current	Category	Typical applications	Test conditions for the number of on-load operating cycles (normal service)						Test conditions for making and breaking capacities (operation in fault case)											
			Make			Break			Make			Break								
			I/le	U/Ue	L/R	Ic/le	Ur/Ue	L/R	I/le	U/Ue	L/R	Ic/le	Ur/Ue	L/R						
Direct current	<b>DC21A</b> frequent operation	<b>DC21B</b> infrequent operation	Switching of resistive loads including moderate overloads						1	1	1ms	1	1	1ms	1,5	1,05	1ms	1,5	1,05	1ms
	<b>DC22A</b> frequent operation	<b>DC22B</b> infrequent operation	Switching of mixed resistive a.induct. loads incl. moderate overloads (shunt motors)						1	1	2ms	1	1	2ms	4	1,05	2,5ms	4	1,05	2,5ms
	<b>DC-PV1</b>		Switching of single PV string(s) without reverse- and overcurrents.						1	1	1ms	1	1	1ms	1,5	1,05	1ms	1,5	1,05	1ms
	<b>DC-PV2</b>		Switching of several PV strings with reverse- and overcurrents.						1	1	1ms	1	1	1ms	4	1,05	1ms	4	1,05	1ms

## Data according to IEC 60947-3, VDE 0660, GB/T14048.3 (CCC China)



Main contacts		Typ	LS16	LS25	LS32	LS38	LS40	LS55	
Rated thermal current $I_{th}$		A	16	25	32	45	48	55	
Rated insulation voltage $U_i^{(1)}$		V	1000	1000	1000	1000	1500	1500	
Rated insulation voltage $U_i^{(2)}$		V	1500	1500	1500	1500	1500	1500	
Distance of contacts (per pole)		mm	8	8	8	8	8	8	
<b>DC21A and DC21B</b>	1 pole	300V A	16	23	27	27	40	55	
		400V A	12/14	14/22	16/25	16/25	30/33	40/44	
	A1	500V A	9/10	11/17	13/20	13/20	19/24	25/32	
		600V A	6/7	8/12	10/15	10/15	15/19	20/25	
	1	700V A	4,5/5	6	7,5	7,5	10/12	15/18	
		800V A	3	4	5	5	8/10	10/13	
	only DC21B	900V A	2,5/3	3	4	4	6/8	8/10	
		1000V A	1,5/2	2	2,5/3	2,5/3	4/5	6/8	
	2 poles in series	500V A	16	25	32	-/45	48	55	
		600V A	16	25	32	-/45	48	55	
	A2	700V A	16	23/25	27/32	-/36	35/37	55	
		800V A	16/16	20	-/23	-/30	35	45/55	
	1 2	900V A	13/16	16/17	-/20	-/25	25/31	35/43	
		1000V A	9/10	11/11,5	13	-/20	25/29	-/36	
	1200V A	6/7	8/8,5	10	10	10/11	15/17		
		1500V A	3	4/5	5/6	-/6	6/7,5	7,5/10	
	2 poles in series + 2 poles parallel	500V A	29	45	58	-/65	72	85	
		600V A	29	45	50/55		64/68	80/85	
	A2+2	700V A	16/22	23/27	27/32		35/49	55/77	
		800V A	16/17	20	-/23	-/30	35/42	45/63	
1 2 3 4	900V A	13/16	16/17	-/20		25/31	35/43		
	1000V A	9/10	11/11,5	13	-/20	23/29	25/36		
1200V A	6/7	8/8,5	10	10	10/11	15/17			
	1500V A	3	4/5	5/6	-/6	6/7,5	7,5/10		
3 poles in series + 2 poles parallel	500V A	29	45	58		72	85		
	600V A	29	45	50/58		72	85		
A3+2	700V A	29	38/43	45/55		72	85		
	800V A	29	38/40	-/51		68	85		
1 2 3 4 5 6	900V A	29	-/38	-/47		62	78		
	1000V A	29	-/38	-/45		58	70		
1200V A	12	14/25	16/28						
	1500V A	9	11/14	13/20					
4 poles in series	500V A	16	25	32	-/45	48	55		
	600V A	16	25	32	-/45	48	55		
A4	700V A	16	25	32		40	55		
	800V A	16	25	32		40	55		
1 2 3 4	900V A	16	25	32		40	55		
	1000V A	16	25	32	-/38	40	55		
1200V A	16	25	32		40	55			
	1500V A	16	20/25	23/32	-/32	30/40	40/55		
4 poles in series + 2 poles parallel	500V A	29	45	58	-/65	72	85		
	600V A	29	45	58		72	85		
A4+2	700V A	29	45	-/58		72	85		
	800V A	29	45	-/58		72	85		
1 2 3 4 5 6 7 8	900V A	29	45	-/58		72	85		
	1000V A	29	-/45	-/58	-/65	-/72	-/85		
1200V A	29	-/45	50	-/50	-/56	-/65			
	1500V A	16	20/26	23/32	-/32	-/42	-/55		
<b>Rated operational current <math>I_e</math></b>									
<b>AC21B</b>	A2, A4	$U_e$ max. 440V	A	16	25	32	45	48	55
	A2+2	$U_e$ max. 440V	A	29	45	58		72	85

1) Suitable at overvoltage category I to III, pollution degree 3 (standard-industry):  $U_{imp} = 8kV$ .

2) Suitable at overvoltage category I to III, pollution degree 2 (min. IP55):  $U_{imp} = 8kV$ .

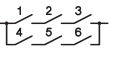
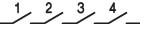
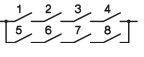

# Technical Data

Data according to IEC 60947-3, VDE 0660

Main contacts	Type		LS16	LS25	LS32	LS38	LS40	LS55	
<b>Rated operational current I<sub>e</sub></b> <b>DC-PV1</b>	300V	A	16	23	27	27	40	55	
	400V	A	14	22	25	25	33	44	
1 pole A1 	500V	A	10	17	20	20	24	32	
	600V	A	7	12	15	15	19	25	
	700V	A	5	6	7,5	7,5	12	18	
	800V	A	3	4	5	5	10	13	
	900V	A	3	3	4	4	8	10	
	1000V	A	2	2	3	3	5	8	
	2 poles in series A2 	500V	A	16	25	32	45	48	55
		600V	A	16	25	32	45	48	55
700V		A	16	25	32	36	37	55	
800V		A	16	20	23	30	35	55	
900V		A	16	17	20	25	31	43	
1000V		A	10	11,5	13	20	29	36	
1100V		A	8	10	11,5	-	19	25	
1200V		A	7	8,5	10	10	11	17	
1300V		A	6	7	8	-	10	14	
1400V		A	5	6	7	-	9	12	
1500V		A	3	5	6	6	8	10	
2 poles in series + 2 poles parallel A2+2 		500V	A	29	45	58	65	72	85
		600V	A	29	45	55	58	68	85
	700V	A	22	27	32	36	49	77	
	800V	A	17	20	23	30	42	63	
	900V	A	16	17	20	25	31	43	
	1000V	A	10	11,5	13	20	29	36	
	1100V	A	8	10	11,5	-	19	25	
	1200V	A	7	8,5	10	10	11	17	
	1300V	A	6	7	8	-	10	14	
	1400V	A	5	6	7	-	9	12	
	1500V	A	3	5	6	6	8	10	
	3 poles in series + 2 poles parallel A3+2 	500V	A	29	45	58	-	72	85
		600V	A	29	45	58	-	72	85
700V		A	29	43	55	-	72	85	
800V		A	29	40	51	-	68	85	
900V		A	29	38	47	-	62	78	
1000V		A	29	38	45	-	58	70	
1100V		A	19	27	37	-	-	-	
1200V		A	17	25	28	-	-	-	
1300V		A	15	21	25	-	-	-	
1400V		A	12	18	22	-	-	-	
1500V		A	10	14	20	-	-	-	
4 poles in series A4 		500V	A	16	25	32	45	48	55
		600V	A	16	25	32	45	48	55
	700V	A	16	25	32	45	48	55	
	800V	A	16	25	32	45	48	55	
	900V	A	16	25	32	45	48	55	
	1000V	A	16	25	32	38	40	55	
	1100V	A	16	25	32	-	40	55	
	1200V	A	16	25	32	32	40	55	
	1300V	A	16	25	32	-	40	55	
	1400V	A	16	25	32	-	40	55	
	1500V	A	16	25	32	32	40	55	
	4 poles in series + 2 poles parallel A4+2 	500V	A	29	45	58	65	72	85
		600V	A	29	45	58	65	72	85
700V		A	29	45	58	65	72	85	
800V		A	29	45	58	65	72	85	
900V		A	29	45	58	65	72	85	
1000V		A	29	45	58	65	72	85	
1100V		A	29	45	54	-	60	68	
1200V		A	29	45	50	50	56	65	
1300V		A	26	39	44	-	50	61	
1400V		A	23	33	38	-	46	58	
1500V		A	20	26	32	32	42	55	

# Technical Data

Data according to IEC 60947-3, VDE 0660

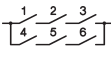
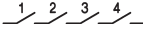
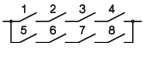
Main contacts	Type		LS16	LS25	LS32	LS38	LS40	LS55
<b>Rated operational current I<sub>e</sub></b> <b>DC-PV2</b>	1 pole A1 	300V A	16	23	27	27	40	55
		400V A	14	18	20	20	30	40
	2 poles in series A2 	500V A	10	12	14	14	19	25
		600V A	5	6	8	8	10	13
		700V A	1,5	2	3	3	7	10
		800V A	1,5	2	3	3	6	8
		900V A	1	1,5	2	2	5	6
		1000V A	1	1,5	2	2	3	4
		2 poles in series + 2 poles parallel A2+2 	500V A	16	25	32	38	40
	600V A		14	21	27	51	40	55
	700V A		13	19	22	25	35	55
	800V A		12	15	17	19	33	49
	900V A		8	10	12	14	25	35
	1000V A		4	5	6	7	16	20
	1100V A		3	4	5	-	11	15
	1200V A		2	3	4	4	8	12
	1300V A		1,5	2	3	-	7	10
	1400V A		1	2	3	-	7	9
	1500V A	1	1,5	2	2	6	8	
3 poles in series + 2 poles parallel A3+2 	500V A	25	39	50	58	72	85	
	600V A	20	32	35	38	60	75	
	700V A	13	19	22	25	38	60	
	800V A	12	15	17	19	33	49	
	900V A	8	10	12	14	25	35	
	1000V A	4	5	6	7	16	20	
	1100V A	3	4	5	-	11	15	
	1200V A	2	3	4	4	8	12	
	1300V A	1,5	2	3	-	7	10	
	1400V A	1	2	3	-	7	9	
	1500V A	1	1,5	2	2	6	8	
4 poles in series A4 	500V A	16	25	32	45	40	55	
	600V A	16	25	32	45	40	55	
	700V A	16	25	32	45	40	55	
	800V A	16	25	32	38	40	55	
	900V A	16	25	32	38	40	55	
	1000V A	16	25	32	38	40	55	
	1100V A	15	25	32	-	40	55	
	1200V A	13,5	21	27	27	40	55	
	1300V A	12	19	24	-	36	50	
	1400V A	10,5	16	21	-	33	45	
	1500V A	9	14	18	18	30	40	
	4 poles in series + 2 poles parallel A4+2 	500V A	29	45	58	65	72	85
		600V A	29	45	58	65	72	85
700V A		25	40	53	65	72	80	
800V A		21	35	45	60	67	75	
900V A		18	30	37	55	59	70	
1000V A		16	25	32	50	52	64	
1100V A		-	-	-	-	44	59	
1200V A		13,5	21	27	27	40	55	
1300V A		-	-	-	-	36	50	
1400V A		-	-	-	-	33	45	
1500V A		9	14	18	18	30	40	

Contactor, Motor-Starters

Circuit Breakers

Manual Motor-Starters

Switches

AC-Main Switches



DC-Switch Disconnectors

Push Buttons

Representatives, Suppliers

# Technical Data

Data according to IEC 60947-3, VDE 0660

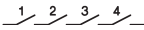





Main contacts		Type	LS16	LS25	LS32	LS38	LS40	LS55	
<b>Rated operational current I<sub>e</sub></b>		500V	A	1	1,25	1,5	x	x	2,5
<b>DC22B</b>		600V	A	0,5	0,75	1	x	x	2,0
1 pole		800V	A	0,3	0,4	0,5	x	x	1,5
A1		1000V	A	0,15	0,2	0,25	x	x	1,0
		1200V	A	-	-	-	x	x	x
		1500V	A	-	-	-	x	x	x
2 poles in series		500V	A	7	8	9	x	x	x
A2		600V	A	5,5	6	6,5	x	x	x
		800V	A	2	2,5	3	x	x	x
		1000V	A	1	1,5	2	x	x	x
		1200V	A	-	-	-	x	x	x
		1500V	A	-	-	-	x	x	x
4 poles in series		500V	A	16	25	32	x	x	x
A4		600V	A	16	25	27,5	x	x	x
		800V	A	11,5	12	12,5	x	x	x
		1000V	A	8	9	10	x	x	x
		1200V	A	-	-	-	x	x	x
		1500V	A	-	-	-	x	x	x
<b>Rated conditional short-circuit current</b>		kA <sub>eff</sub>		5	5	5	5	10	10
Max. fuse size		gL (gG)	A	40	63	80	80	125	160
Mechanical life		x10 <sup>3</sup>		10	10	10	10	10	10
Rated short-time withstand current (1s)		lcw A2, A4, A6, A8	A	800	900	1000	1000	A2, A4: 1200	A2, A4: 1400
		A2+2, A3+2, A4+2	A	1300	1500	1700	1700	A2+2: 2000	A2+2: 2400
Short circuit making capacity		lcm A2, A4, A6, A8	A	800	900	1000	1000	A2, A4: 1200	A2, A4: 1400
		A2+2, A3+2, A4+2	A	1300	1500	1700	1700	A2+2: 2000	A2+2: 2400
<b>Maximum cable cross sections (incl. jumper)</b>			LSV-B1	LSV-B1	LSV-B1	LSV-B1	LSV-B2	LSV-B2	
solid or stranded		mm <sup>2</sup>	4 - 16	4 - 16	4 - 16	4-16	2,5 - 25	2,5 - 25	
flexible		mm <sup>2</sup>	4 - 10	4 - 10	4 - 10	4-10	2,5 - 16	2,5 - 16	
flexible (+ multicore cable end)		mm <sup>2</sup>	4 - 10	4 - 10	4 - 10	4-10	1,5 - 16	1,5 - 16	
Size of terminal screw			M4 Pz2	M4 Pz2	M4 Pz2	M4 Pz2	M5 Pz2	M5 Pz2	
Tightening torque		Nm	1,8 - 2	1,8 - 2	1,8 - 2	1,8 - 2	2,5 - 2,8	2,5 - 2,8	
2 cables per terminal without jumper LSV-B1 / LSV-B2									
solid or stranded		mm <sup>2</sup>	16+(1,5-2,5) / 10+(1,5-6) / 6+(1,5-10) / 4+(1,5-10)				16+(1,5-2,5) / 10+(1,5-10) / 6+(1,5-10) / 4+(1,5-10)		
flexible & flexible + multicore cable end		mm <sup>2</sup>	16+(1,5-2,5) / 10+(1,5-4) / 6+(1,5-6)				16+(1,5-6) / 10+(1,5-10) / 6+(1,5-16) / 4+(1,5-16)		
stranded		AWG	8+(16-12) / 10+(16-10) / 12+(16-8) 14+(16-8)				3+(18-10) / 4+(18-10) / 6+(18-8) 8+(18-8)		
solid		AWG	10+(16-12) / 12+(16-10) 14+(16-10)				10+(16-10) / 12+(16-10) / 14+(16-10) 12+(16-10)/14+(16-10)		
<b>Maximum ambient temperature</b>									
Operation		open	°C	-40 to +65					
		enclosed	°C	-40 to +45					
Storage			°C	-50 to +90					
<b>Power loss</b> per switch at I <sub>e</sub> max.			A	A	A		A	A	
A2		(A)/W	(16)/ 1	(25)/ 2,3	(32)/ 3,7		(40)/ 4	(55)/ 7,5	
A4		(A)/W	(16)/ 2	(25)/ 4,6	(32)/ 7,4		(40)/ 8	(55)/ 15	
A6		(A)/W	(16)/ 3	(25)/ 6,9	(32)/ 11,1		(40)/ 12	(55)/ 22,5	
A8		(A)/W	(16)/ 4	(25)/ 9,2	(32)/ 14,8		(40)/ 16	(55)/ 30	
A2+2		(A)/W	(29)/1,5	(45)/ 3,7	(58)/ 6		(72)/ 6,5	(85)/ 9	
A3+2		(A)/W	(29)/2,3	(45)/ 5,6	(58)/ 9		(72)/ 9,8	(85)/ 14	
A4+2		(A)/W	(29)/3	(45)/ 7,4	(58)/ 12		(72)/ 13	(85)/ 18	
<b>Contact resistance</b> per pole		mΩ	1,75	1,75	1,75		1,25	1,25	

x pending



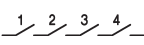
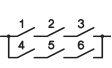
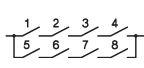



# Technical Data

Data according to UL508I  File E359344 Category np.: NMSJ, und UL508 c  File E332938, Category no.: NRNT2, NRNT8

Type			LS16	LS25	LS32	LS38	LS40	LS55	
Ampere-Rating "General use" 1 pole 	DC								
	350V	A	4	5	6	6	7,1	10,0	
	500V	A	4	5	6	6	5,7	7,0	
	600V	A	4	5	6	6	5,0	5,8	
	700V	A	-	-	-	-	3,9	5,0	
	800V	A	-	-	-	-	3,2	4,4	
	900V	A	-	-	-	-	2,5	3,5	
	1000V	A	-	-	-	-	1,5	2,0	
	2 poles in series A2 	350V	A	16	25	32	38	40	55
		500V	A	16	25	32	38	40	55
		600V	A	16	25	32	36	40	55
		700V	A	-	-	-	-	32	46
		800V	A	-	-	-	-	26	37
		900V	A	-	-	-	-	20	28
2 poles in series + 2 poles parallel A2+2 	350V	A	29	45	58	58	72	85	
	400V	A	-	-	-	-	67	79	
	500V	A	29	38	40	45	53	66	
	600V	A	21	27	32	36	42	55	
	700V	A	-	-	-	-	35	47	
	800V	A	-	-	-	-	30	40	
	900V	A	-	-	-	-	26	32	
	1000V	A	-	-	-	-	22	25	
4 poles in series A4 	350V	A	16	25	32	38	40	55	
	500V	A	16	25	32	38	40	55	
	600V	A	16	25	32	36	40	55	
	700V	A	-	-	-	-	40	55	
	800V	A	-	-	-	-	40	55	
	900V	A	-	-	-	-	40	55	
3 poles in series + 2 poles parallel A3+2 	350V	A	29	45	58	58	72	85	
	500V	A	29	38	50	50	56	80	
	600V	A	21	38	45	45	52	65	
	700V	A	-	-	-	-	46	58	
	800V	A	-	-	-	-	40	51	
	900V	A	-	-	-	-	36	45	
	1000V	A	-	-	-	-	33	42	
	4 poles in series + 2 poles parallel A4+2 	350V	A	29	45	58	58	80	85
500V		A	29	45	58	58	71	85	
600V		A	29	45	50	50	65	85	
700V		A	-	-	-	-	58	76	
800V		A	-	-	-	-	51	71	
900V		A	-	-	-	-	45	67	
1000V		A	-	-	-	-	42	64	
AC-Rating "General use" 2 poles in series 	600V	A	16	25	32	-	40	55	
	277V	A	-	-	50	-	72	85	
	+ 2 poles parallel 								
3 poles parallel 	3x480V	A	-	-	32	-	40	55	
Fuse size (RK5) Industrial Control Switch 5kA / 600V	A		40	60	80	80	-		
5kA/1000V	A		-	-	-	-	160	160	
<b>Max. cable cross sections</b> incl. jumper LSV-B1 / LSV-B2	solid	AWG	12 - 10	12 - 10	12 - 10	12 - 10	16 - 10	16 - 10	
	flexible or stranded	AWG	12 - 6	12 - 6	12 - 6	12 - 6	14 - 4	14 - 4	
	flexible (+ multicore cable end)	AWG	12 - 6	12 - 6	12 - 6	12 - 6			
	Size of terminal screw		M4 Pz2	M4 Pz2	M4 Pz2	M4 Pz2	M5 Pz2	M5 Pz2	
	Tightening torque	Nm	1,8 - 2	1,8 - 2	1,8 - 2	1,8 - 2	2,5 - 2,8	2,5 - 2,8	
Protection class of terminals <sup>1)</sup>			IP20	IP20	IP20	IP20	IP20	IP20	

1) Protection class of the terminals with connected, insulated conductors.

## Approvals

Country	USA, UL508I	US, Canada UL508	Europe	China CCC	CB-Certificates	EAC
Type						
LS16	o	o	/	o	o	o
LS25	o	o	/	o	o	o
LS32	o	o	/	o	o	o
LS38	o	o	/	x	x	o
LS40	o	o	/	-	o	o
LS55	o	o	/	-	o	o

o In standard version approved

/ No testing required CE

x In test

- Not provided for test till now

# Technical Data

## Maximum current according to ambient temperature and cable cross section

Switch open LS16..., 2 contacts in series (A2)

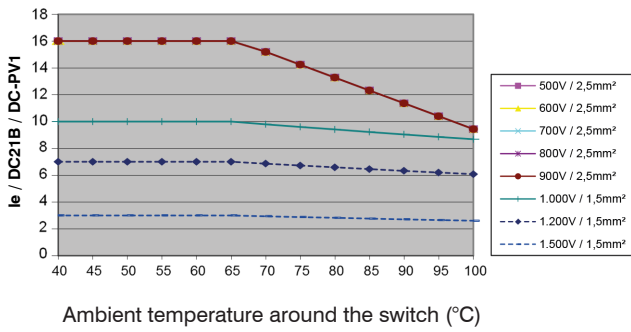

Switch open LS16 ..., 2 contacts in series + 2 parallel (A2+2)

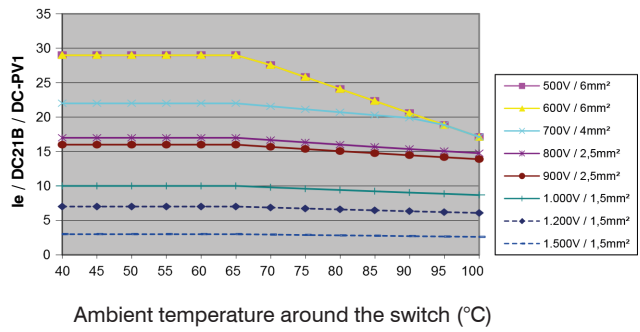

Switch open LS16..., 4 contacts in series (A4x)

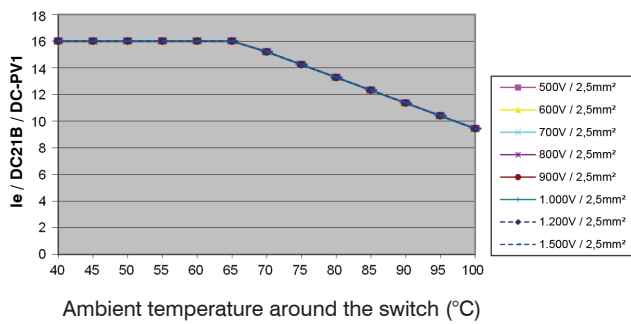

Switch open LS16 ..., 4 contacts in series + 2 parallel (A4+2)

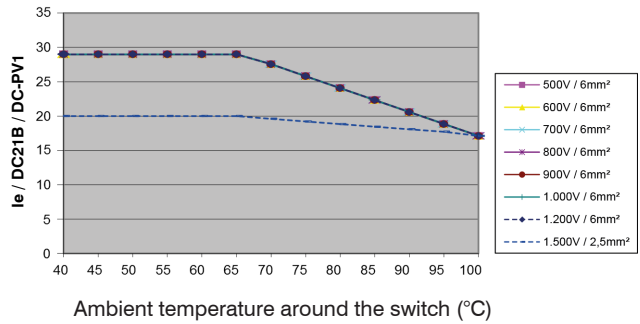

Switch enclosed LS16 PFL..., 2 contacts in series (A2)

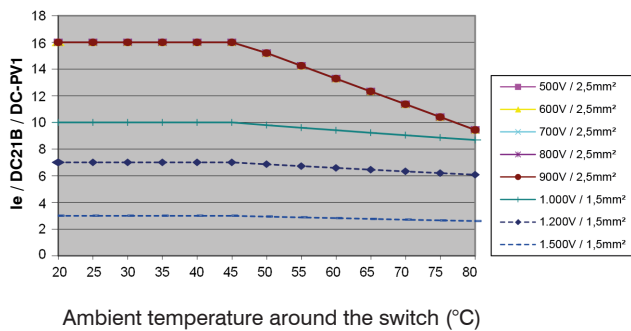

Switch enclosed LS16 PFL..., 2 contacts in series + 2 parallel (A2+2)

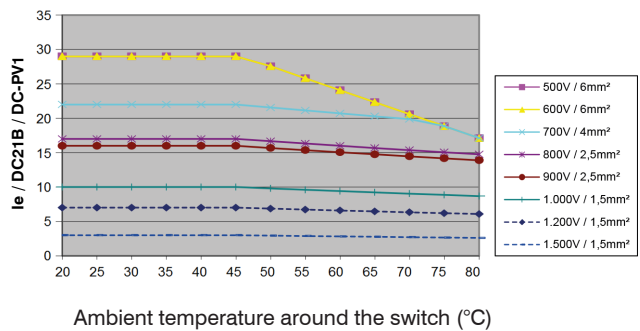

Switch enclosed LS16 PFL..., 4 contacts in series (A4x)

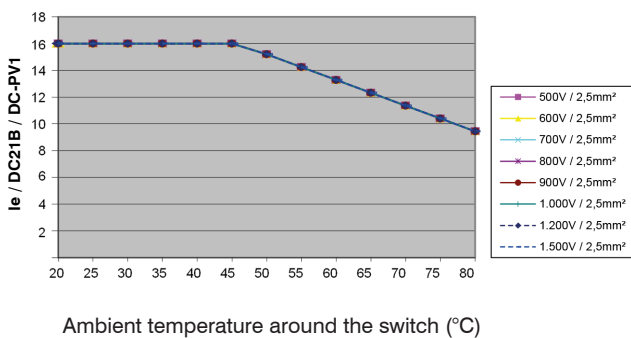

Switch enclosed LS16 PFL..., 4 contacts in series + 2 parallel (A4+2)

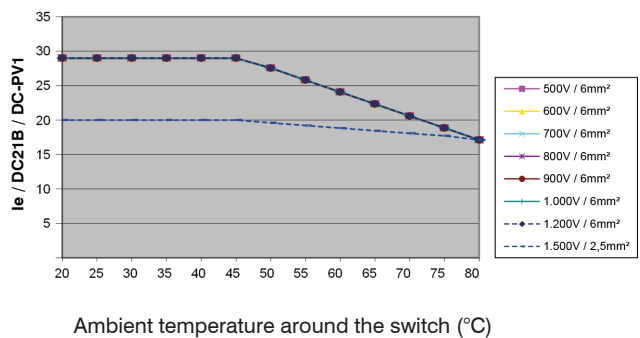

# Technical Data

## Maximum current according to ambient temperature and cable cross section

Switch open LS25..., 2 contacts in series (A2)

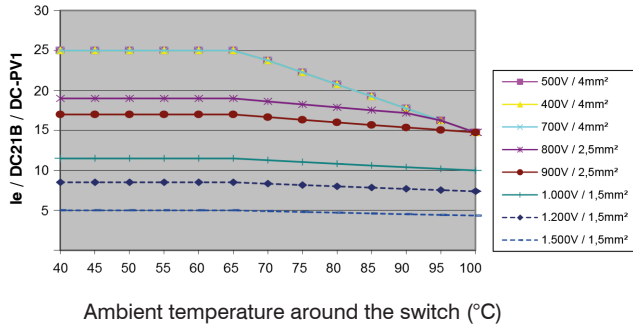

Switch open LS25 ..., 2 contacts in series + 2 parallel (A2+2)

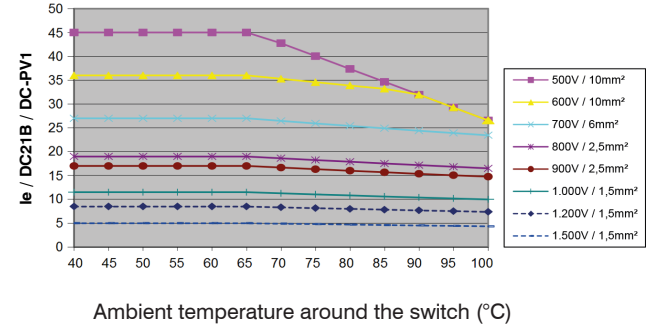

Switch open LS25..., 4 contacts in series (A4x)

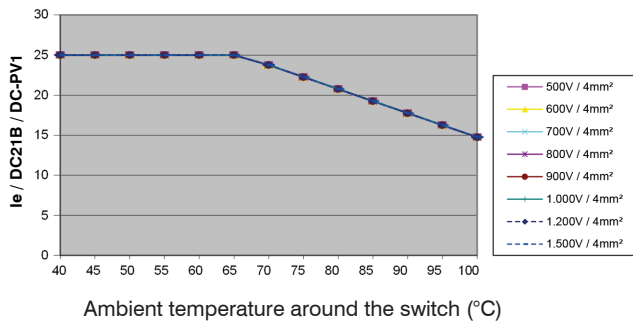

Switch open LS25 ..., 4 contacts in series + 2 parallel (A4+2)

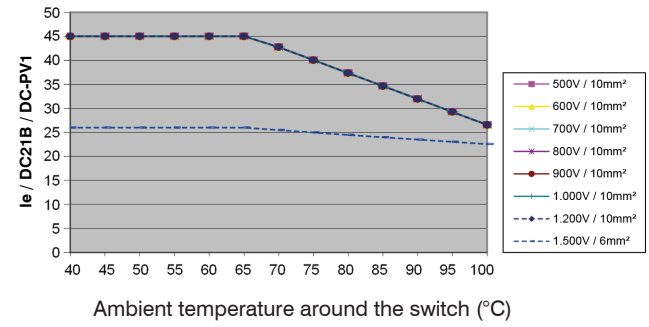

Switch enclosed LS25 PFL..., 2 contacts in series (A2)

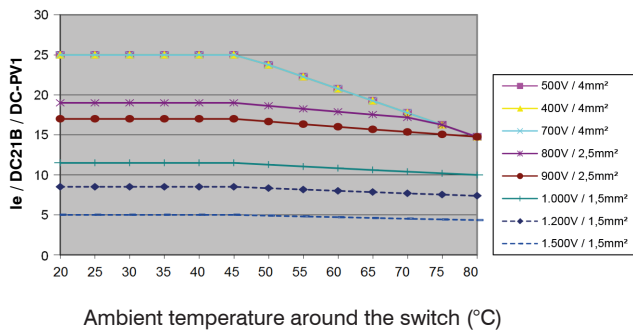

Switch enclosed LS25 PFL..., 2 contacts in series + 2 parallel (A2+2)

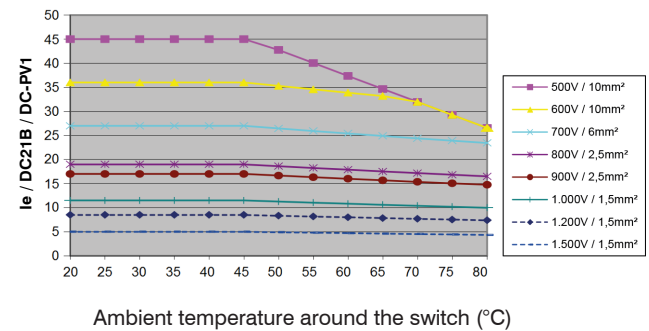

Switch enclosed LS25 PFL..., 4 contacts in series (A4x)

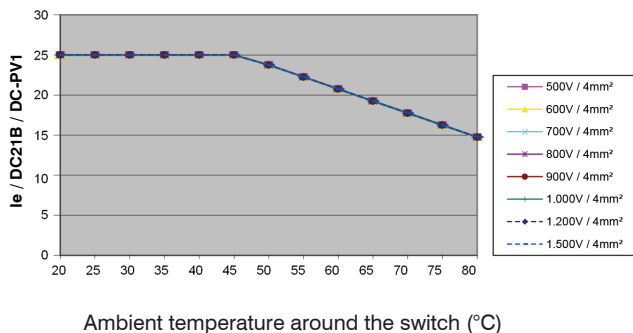

Switch enclosed LS25 PFL..., 4 contacts in series + 2 parallel (A4+2)

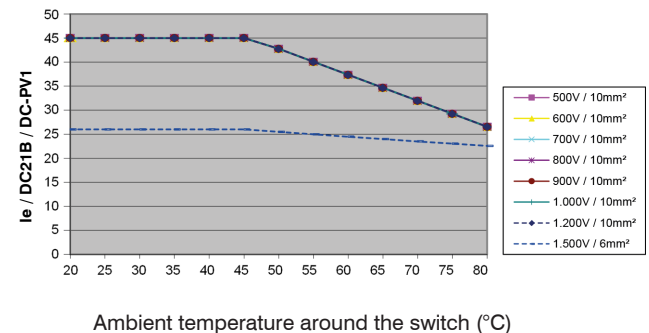

# Technical Data

## Maximum current according to ambient temperature and cable cross section

Switch open LS32..., 2 contacts in series (A2)

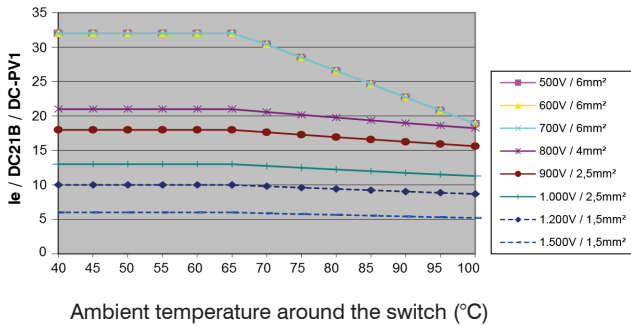

Switch open LS32 ..., 2 contacts in series + 2 parallel (A2+2)

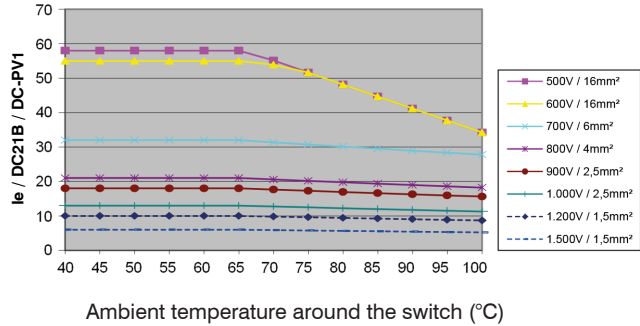

Switch open LS32..., 4 contacts in series (A4x)

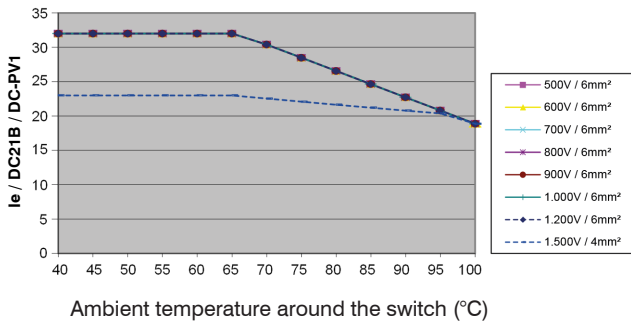

Switch open LS32 ..., 4 contacts in series + 2 parallel (A4+2)

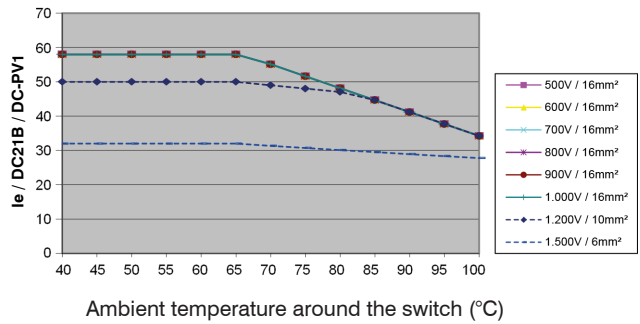

Switch enclosed LS32 PFL..., 2 contacts in series (A2)

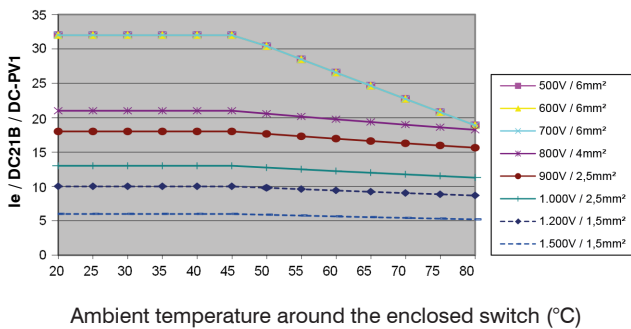

Switch enclosed LS32 PFL..., 2 contacts in series + 2 parallel (A2+2)

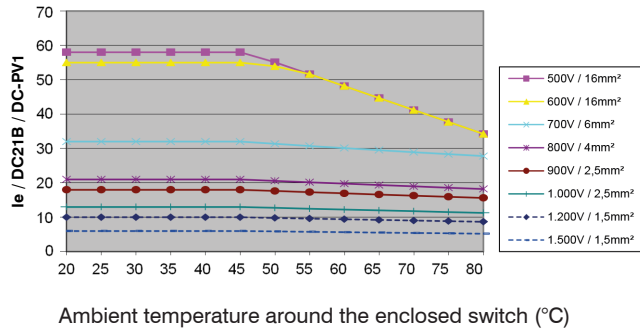

Switch enclosed LS32 PFL..., 4 contacts in series (A4x)

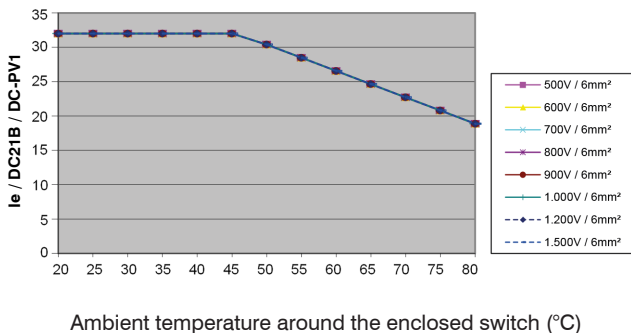

Switch enclosed LS32 PFL..., 4 contacts in series + 2 parallel (A4+2)

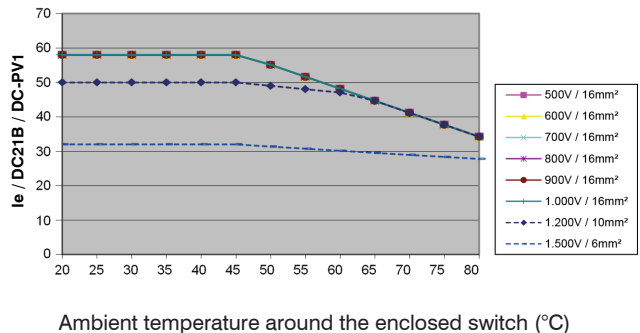

# Technical Data

## Maximum current according to ambient temperature and cable cross section

Switch open LS40..., 2 contacts in series (A2)

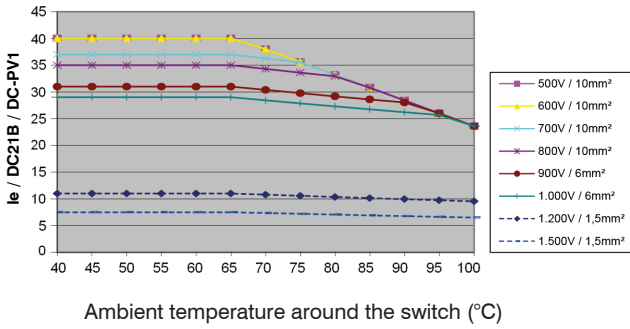

Switch open LS40 ..., 2 contacts in series + 2 parallel (A2+2)

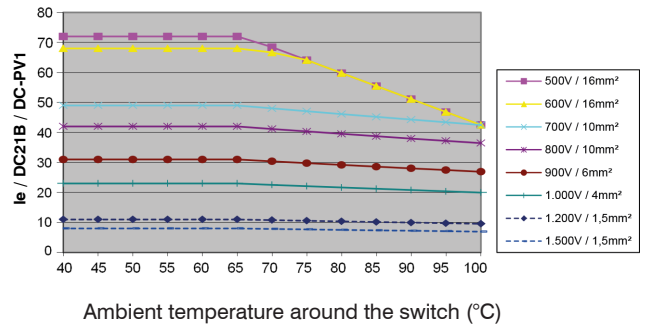

Switch open LS40..., 4 contacts in series (A4x)

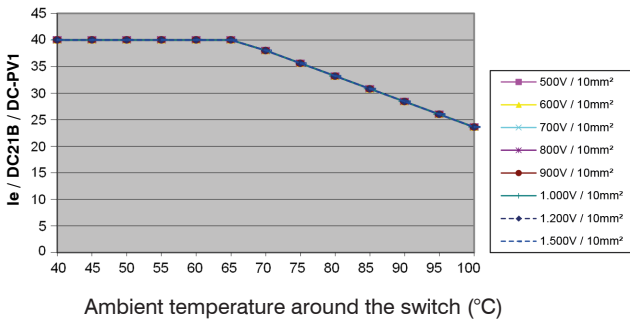

Switch open LS40..., 4 contacts in series + 2 parallel (A4+2)

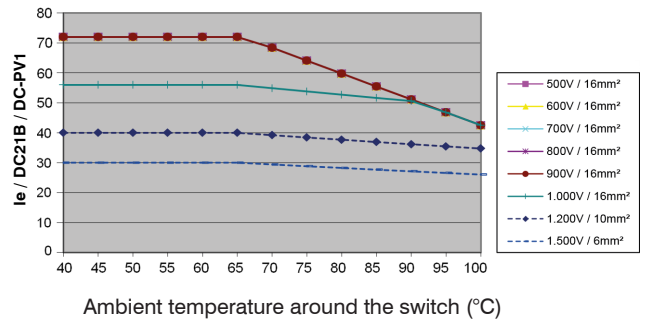

Switch enclosed LS40..., 2 contacts in series (A2)

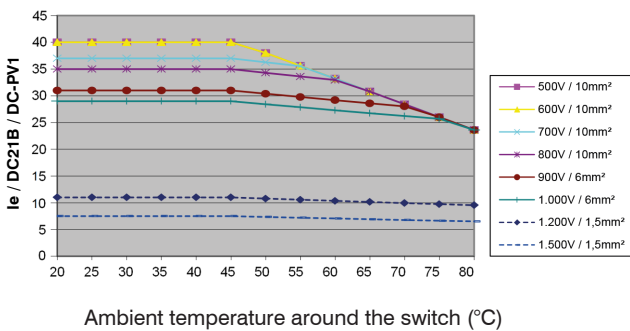

Switch enclosed LS40..., 2 contacts in series + 2 parallel (A2+2)

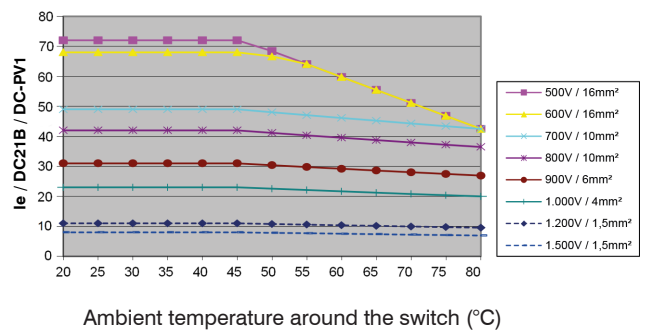

Switch enclosed LS40PFL..., 4 contacts in series (A4x)

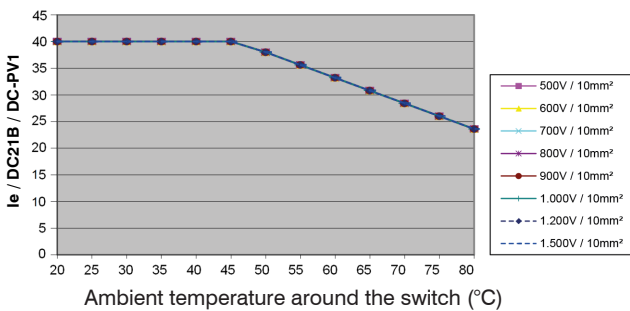

Switch enclosed LS40PFL..., 4 contacts in series + 2parallel (A4+2)

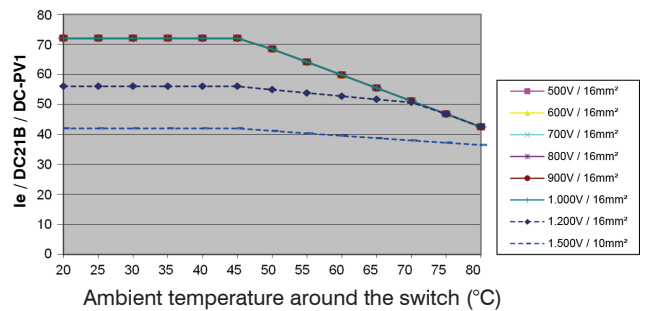

# Technical Data

## Maximum current according to ambient temperature and cable cross section

Switch open LS55..., 2 contacts in series (A2)

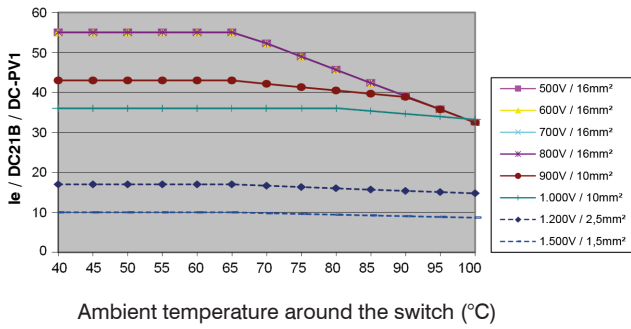

Switch open LS55..., 2 contacts in series + 2 parallel (A2+2)

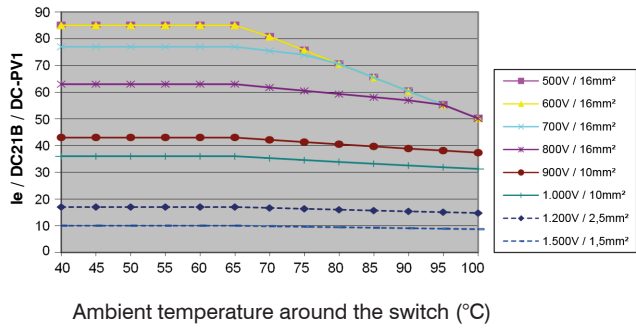

Switch open LS55..., 4 contacts in series (A4x)

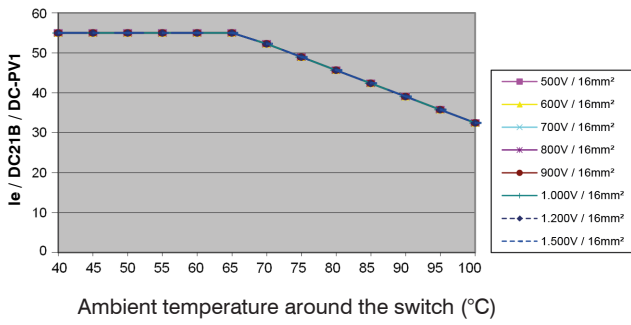

Switch open LS55..., 4 contacts in series + 2 parallel (A4+2)

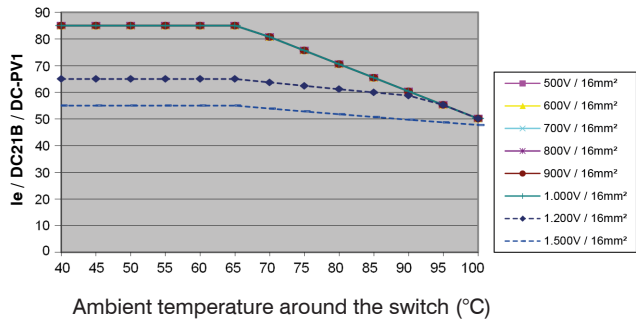

Switch enclosed LS55..., 2 contacts in series (A2)

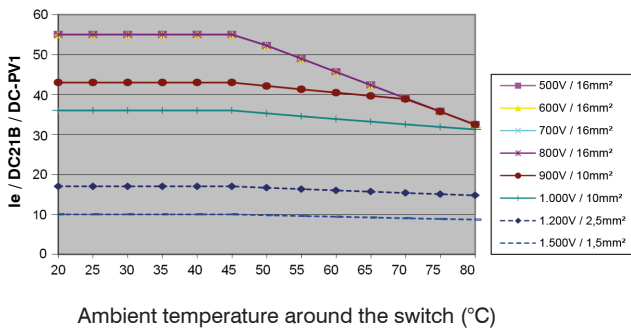

Switch enclosed LS55..., 2 contacts in series + 2 parallel (A2+2)

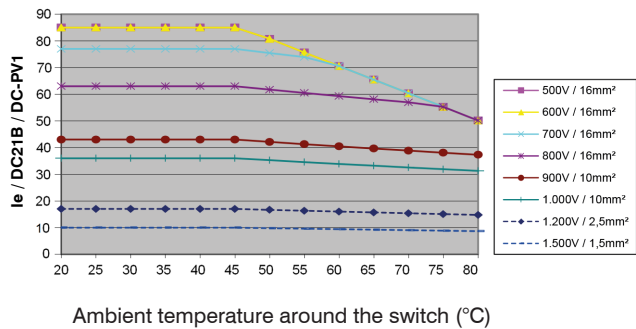

Switch enclosed LS55PFL..., 4 contacts in series (A4x)

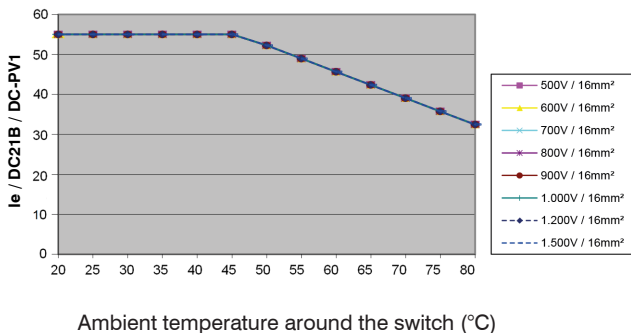

Switch enclosed LS55PFL..., 4 contacts in series + 2parallel (A4+2)

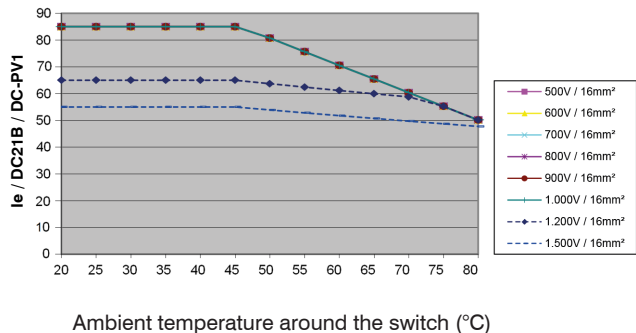

## Dimensions

**LS16 E.., LS25 E.., LS32 E.., LS38 E..**  
**..A2**                      **..A2+2, ..A4.**

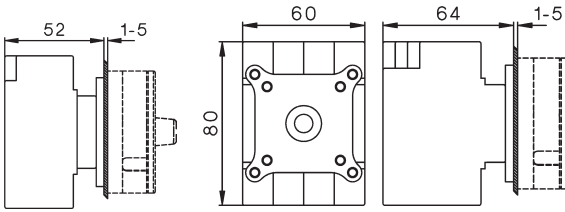

**LS16 E.., LS25 E.., LS32 E.., LS38 E**  
**..A6, ..A8, ..A3+2, ..A4+2**

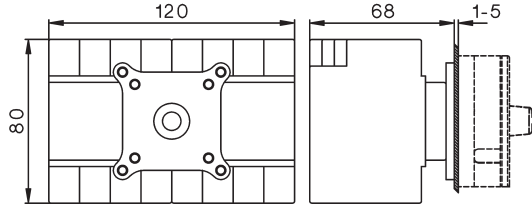

**LS... +VW“x“**  
 Extended Switch Shaft

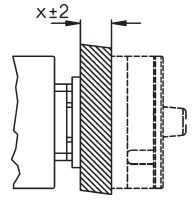

**LS40 E.., LS55 E..**  
**..A2, ..A2+2, ..A4.**

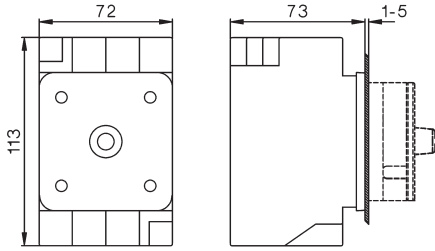

**LS40 E.., LS55 E..**  
**..A6, ..A8, ..A3+2, ..A4+2**

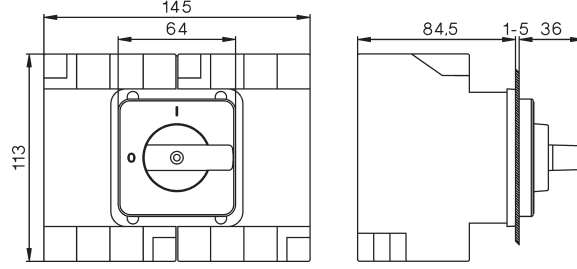

Mounting hole  
 Mounting screw:  
 S3631N M=1,2-1,4 Nm

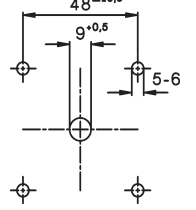

**Escutcheon plate 64<sup>r</sup>**  
 Handle

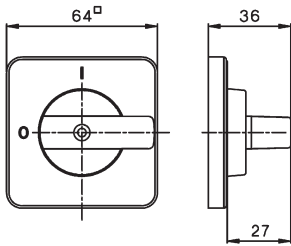

Padlock device SV1.

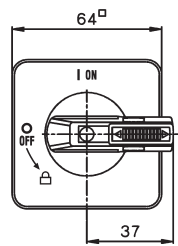

Padlock device SV4.

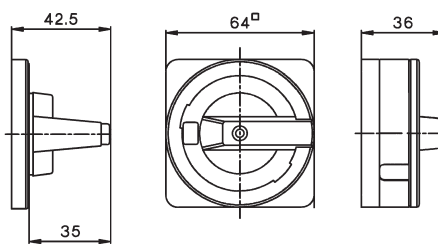

**LS16 Z.., LS25 Z.., LS32 Z.., LS38 Z..**  
**..A2**

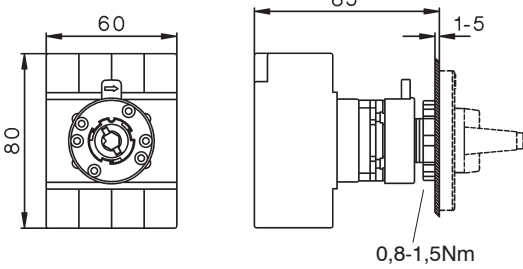

**..A2+2, ..A4.**

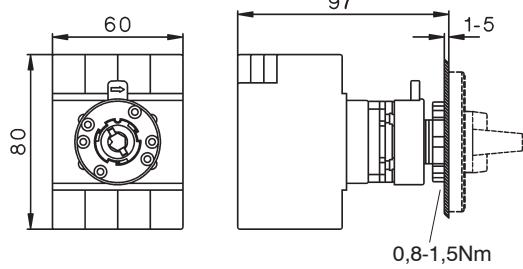

Mounting hole

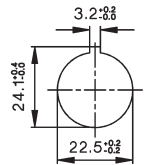

**Escutcheon plate 48<sup>r</sup>**  
 Handle

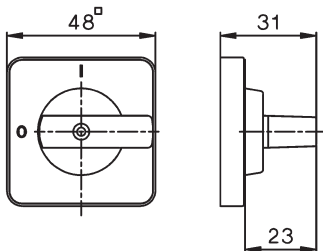

Padlock device SV1.

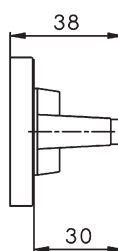
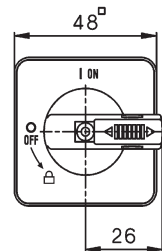

## Dimensions

**LS16 Z., LS25 Z., LS32 Z., LS38 Z.**  
**..A6, ..A8, ..A3+2, ..A4+2**

**LS.. ZO..**

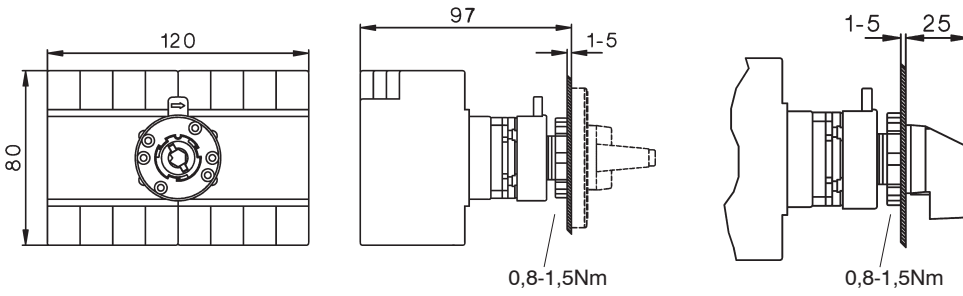

**LS16 VZV., LS25 VZV., LS32 VZV., LS38 VZV.**  
**..A2, ..A2+2, ..A4**

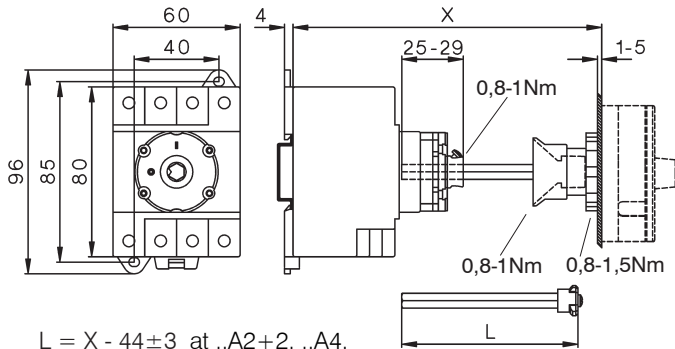

delivered with: ..A2+2, ..A4.

$X_{max} = 194, L = 150$   
 ( $X_{min} = 89$ )

delivered with: ..A2

$X_{max} = 182, L = 150$   
 ( $X_{min} = 77$ )

Bigger X-Dimensions on request

$L = X - 44 \pm 3$  at ..A2+2, ..A4.  
 $L = X - 32 \pm 3$  at ..A2

**LS16 VZV., LS25 VZV., LS32 VZV., LS38 VZV.**  
**..A6, ..A8, ..A3+2, ..A4+2**

Mounting hole

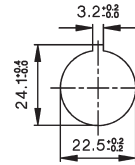
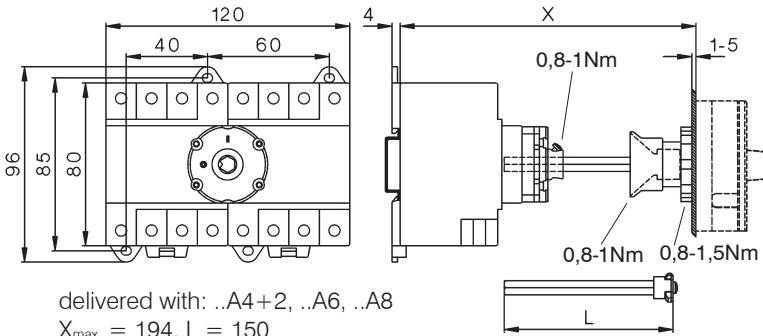

delivered with: ..A4+2, ..A6, ..A8  
 $X_{max} = 194, L = 150$   
 ( $X_{min} = 95$ )

$L = X - 49 \pm 3$

**LS40 VZV., LS55 VZV.**  
**..A2, ..A2+2, ..A4.**

**LS40 VZV., LS55 VZV.**  
**..A6, ..A8, ..A3+2, ..A4+2**

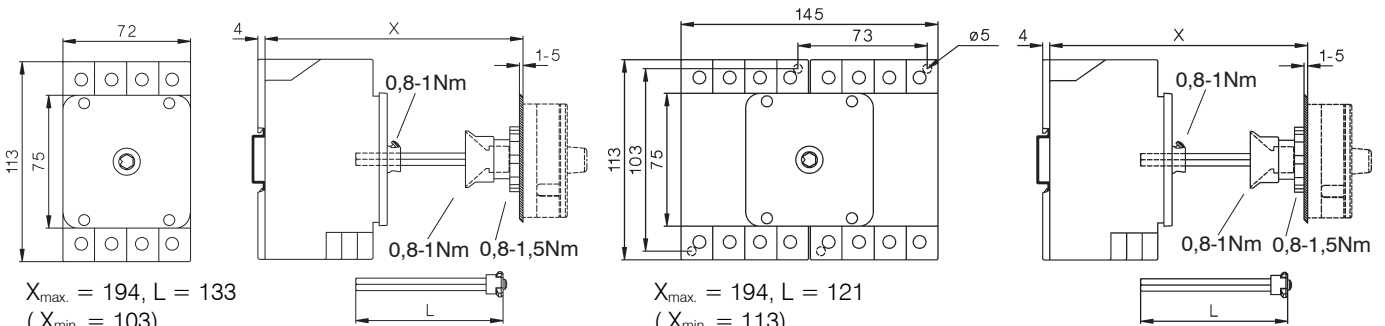

$X_{max} = 194, L = 133$   
 ( $X_{min} = 103$ )

$L = X - 61 \pm 3$

$X_{max} = 194, L = 121$   
 ( $X_{min} = 113$ )

$L = X - 73 \pm 3$



## Dimensions

LS16 SMA..., LS25 SMA..., LS32 SMA..., LS38 SMA..  
..A2

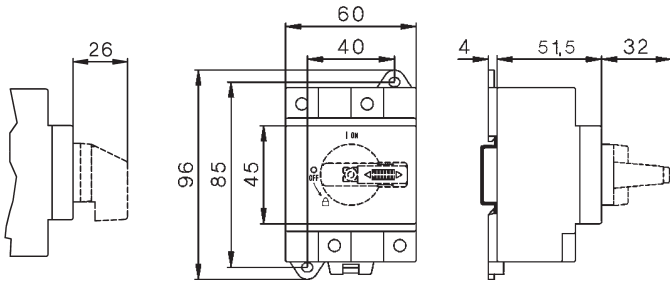

..A2+2, ..A4

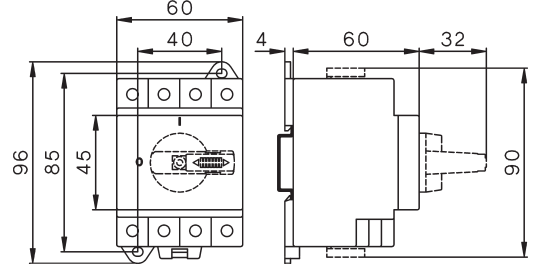

LS40 SMA..., LS55 SMA..  
..A2, ..A2+2, ..A4

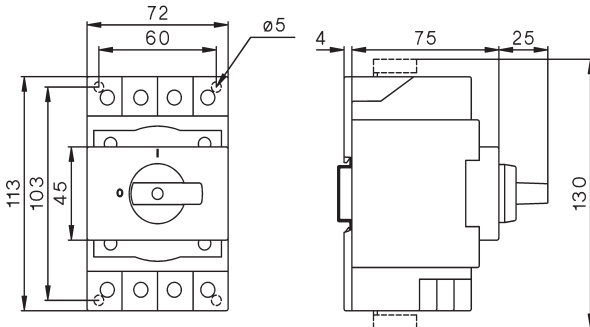

LS40 SMA..., LS55 SMA..  
..A6, ..A8, ..A3+2, ..A4+2

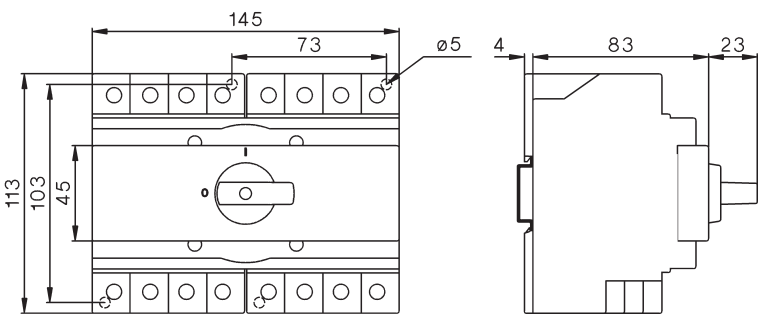

LS16 SMA..., LS25 SMA..., LS32 SMA..., LS38 SMA..  
..A6, ..A8, ..A3+2, ..A4+2

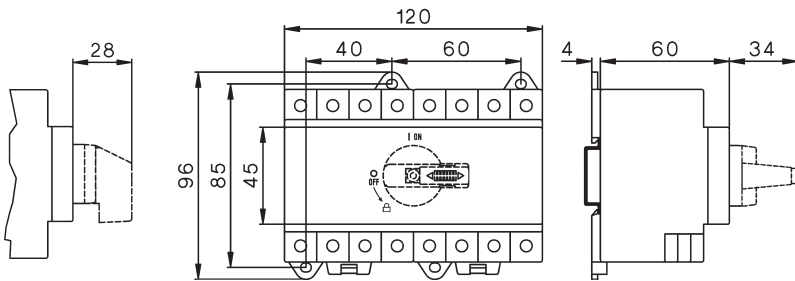

LS.. SMAH1.. with low height handle  
A2 +SV1N

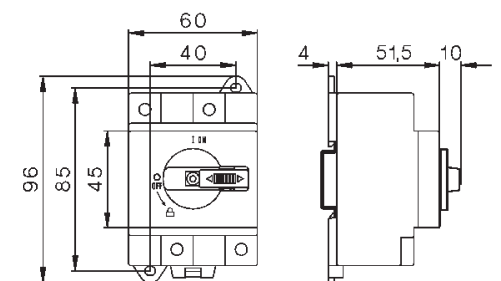

LS16 SMAH1..., LS25 SMAH1..., LS32 SMAH1..., LS38 SMAH1.. with low height handle  
A2+2 +SV1N, A4 +SV1N

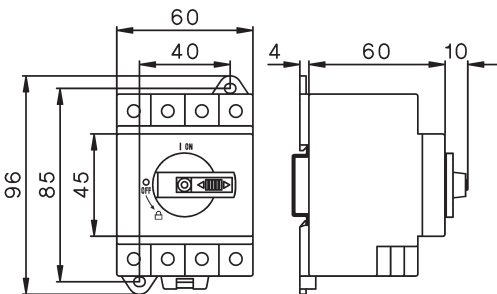

A4+2 +SV1N, A6 +SV1N, A8 +SV1N

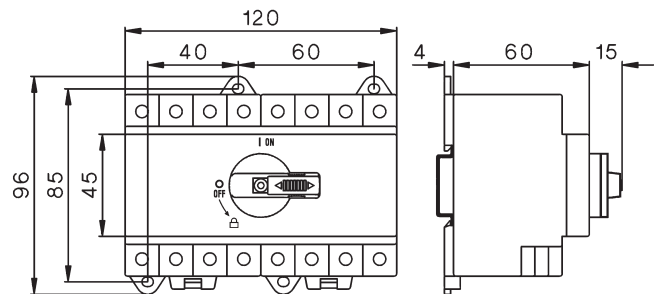

**Dimensions:**

**LS16 PFL..., LS25 PFL..., LS32 PFL..., LS38 PFL...  
..A2, ..A2+2, ..A4.**

**LS16 PFL..., LS25 PFL..., LS32 PFL..., LS38 PFL...  
..A2, ..A2+2, ..A4.  
+ M25**

**Main-Switch (lockable)  
LS..PFLH4 A..**

**Main-Switch (lockable)  
LS..PFLH4 A..**

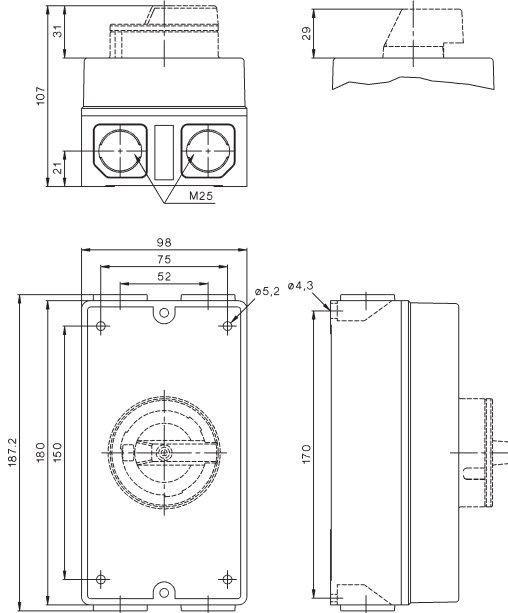
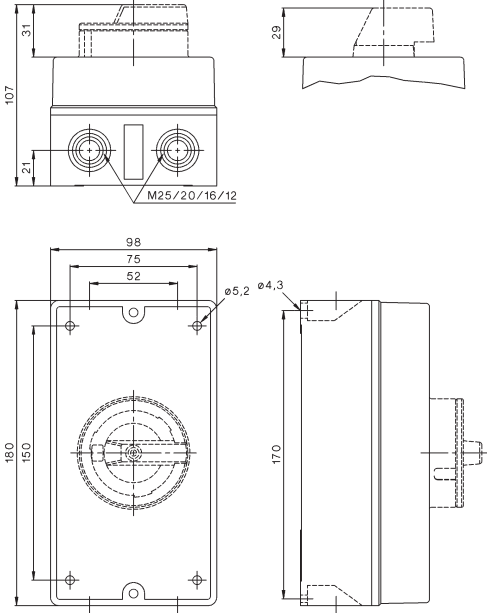

**LS16 PFL..., LS25 PFL..., LS32 PFL..., LS38 PFL...,  
..A2, ..A4, ..A6, ..A8, ..A2+2, ..A3+2, ..A4+2  
LS40 PFL..., LS55 PFL..  
..A6, ..A8, ..A3+2, ..A4+2**

**Main-Switch (lockable)  
LS..PFLH4 A..**

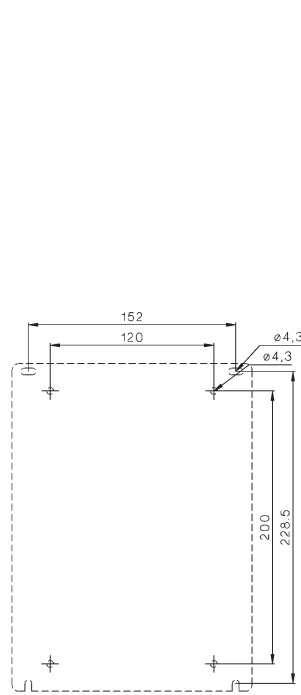
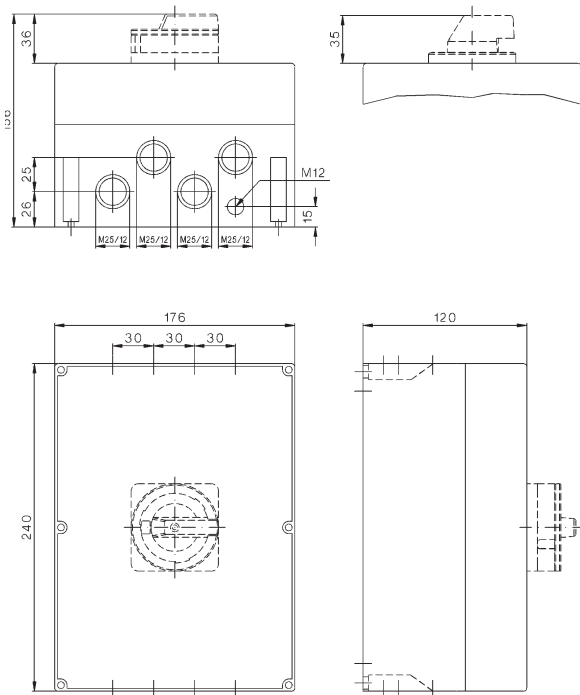

**Dimensions:**

**LS40 PFL..., LS55 PFL...,  
..A2, ..A4, ..A2+2**

**Main-Switch (lockable)  
LS..PFLH4 A.. +PF2**

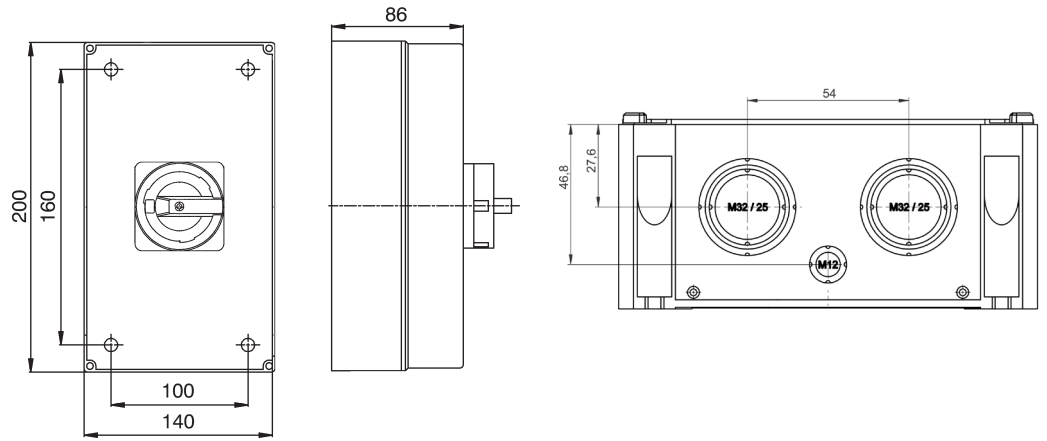

**Insulated Jumpers LSV-.. for series and parallel switching of contacts:**

**LS16.., LS25.., LS32.., LS38..**

**LSV-B1-1**

**LSV-B1-2**



**LS.. E A2+2**

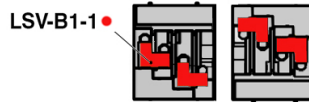

**LS.. E A3+2**

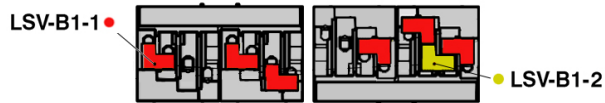

**LS.. V A4+2U**



**LS40.., LS55..**

**LSV-B2-1**

**LSV-B2-2**



**LS.. E A2+2**

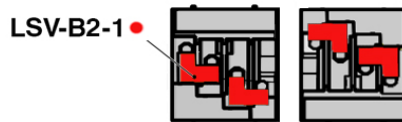

**LS.. E A3+2**

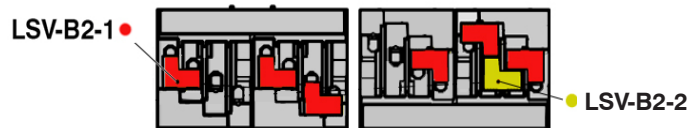

**LS.. V A4+2U**



