

Inhalt

Seite



EIN-AUS-Schalter für Einbau 4-Lochbefestigung

306



EIN-AUS-Schalter für Zentralbefestigung

307



EIN-AUS-Schalter für Bodenmontage

308



EIN-AUS-Schalter für Reiheneinbau

309



Hauptschalter für Einbau 4-Lochbefestigung

310



Hauptschalter für Zentralbefestigung

311



Hauptschalter für Bodenmontage

312



Hauptschalter für Reiheneinbau

313



Hauptschalter, isolierstoffgekapselt

314



Technische Daten
Approbationen

315

319

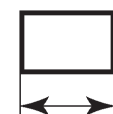

Maße

321

Schütze, Motorstarter

Leistungsschalter

Motorschutzschalter

Schalter

AC-Hauptschalter

DC-Lasttrennschalter

Befehls- und Meldegeräte

Vertretungen, Bezugsquellen

Nennwerte				DC-Lasttrennschalter			
Nennbetriebsstrom				Bauformen			
Typ	I_{th} offen	DC21B(DC-PV1) bei U_e		Fronteinbau Vierlochbefestigung IP66 ¹⁾ Type 3R	Zentral- mit Tür- kupplung Ø22,5mm IP66 ¹⁾ Type 4X	Verteilereinbau IP66 ¹⁾ Type 4X	Reiheneinbau IP40 ¹⁾ Open Type
	A	A	V				
LS16	16	16	1500	.. E Z(O) VZV SMA ..
LS25	25	25	1500	.. E Z(O) VZV SMA ..
LS32	32	32	1500	.. E Z(O) VZV SMA ..
LS38	38	38	1500	.. E Z(O) VZV SMA ..
LS40	40	40	1500	.. E ..	-	.. VZV SMA ..
LS55	55	55	1500	.. E ..	-	.. VZV SMA ..
LS65	65	65	1500	.. E ..	-	.. VZV SMA ..

Lasttrennschalter für Photovoltaik

Gemäß IEC 60364-7-712 „Errichten von Photovoltaik-Versorgungssystemen“ ist eine Einrichtung zum Trennen (= Lasttrennschalter) der Photovoltaik-Module vom Wechselrichter verbindlich vorgeschrieben.

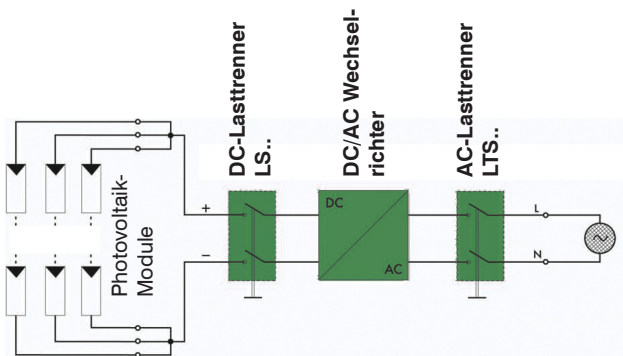

Lasttrennschalter „LS“ gewährleisten ein zuverlässiges Schalten von bis zu 85A bei 1500V in der Kategorie DC21B (DC-PV1).

Die Kontakte sind gegen Oxydation (geringe Schalthäufigkeit) und somit gegen unzulässige Erwärmung geschützt.

Der Lasttrennschalter ist mit 2, 4, 6 oder 8 schaltbaren, einzelnen Kontakten ausgestattet. Durch Serien- und Parallelschaltung der Kontakte kann die Schaltleistung entsprechend erhöht werden.

Die hohe Schaltgeschwindigkeit der Kontakte ist unabhängig von der Betätigungsgeschwindigkeit des Handgriffes.

Bestellanleitung

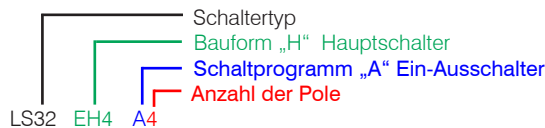

Schaltprogramme

Typ	2-polig	2+2-polig 2 Pole in Serie + 2 Pole parallel	4-polig	4-polig mit Brücken Einspeisung oben Abgang unten	4-polig 2 Brücken oben Einspeisung und Abgang unten	4-polig 2 Brücken unten Einspeisung und Abgang oben
LS16 ... LS65	.. A2	.. A2+2	.. A4(2 x A2)	.. A4B	.. A4O	.. A4U

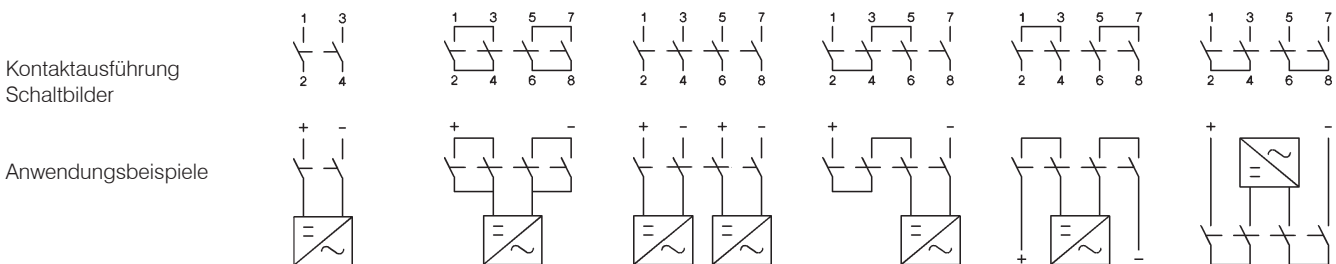

1) Schutzart von vorne im eingebauten Zustand

DC-Hauptschalter

Fronteinbau
Vierlochbefestigung
IP66¹⁾ Type 3R



Zentralbefestigung
Ø22,5mm
IP66¹⁾ Type 4X



Verteilereinbau
mit Türkupplung
IP66¹⁾ Type 4X



Reiheneinbau
IP40¹⁾ Open Type



Preßstoffgekapselt
PFL..IP66/67 Type 4X



.. EH4 Z(O)H1 VZVH4 SMAH1 PFLH4 ..
.. EH4 Z(O)H1 VZVH4 SMAH1 PFLH4 ..
.. EH4 Z(O)H1 VZVH4 SMAH1 PFLH4 ..
.. EH4 Z(O)H1 VZVH4 SMAH1 PFLH4 ..
.. EH4 ..	-	.. VZVH4 SMAH1 PFLH4 ..
.. EH4 ..	-	.. VZVH4 SMAH1 PFLH4 ..
.. EH4 ..	-	.. VZVH4 SMAH1 PFLH4 ..

Technische Daten für DC, nach IEC 60947-3, VDE0660, weitere Daten siehe Seite 315.

Typ	DC-PV1 (=DC21B)								
		500V	600V	700V	800V	900V	1000V	1200V	1500V
2 Pole in Serie 	LS16.. A	16	16	16	16	16	10	7	3
	LS25.. A	25	25	25	20	17	11,5	8,5	5
	LS32.. A	32	32	32	23	20	13	10	6
	LS38.. A	45	45	-	30	-	20	-	-
	LS40.. A	48	48	37	35	31	29	11	7,5
	LS55.. A	55	55	55	55	43	36	17	10
	LS65.. A	65	65	65	65	55	40	17	10
2 Pole in Serie+2 parallel 	LS16.. A	29	29	22	17	16	10	7	3
	LS25.. A	45	36	27	19	17	11,5	8,5	5
	LS32.. A	58	55	32	23	20	13	10	6
	LS38.. A	-	-	-	30	-	20	-	-
	LS40.. A	72	68	49	42	31	29	11	7,5
	LS55.. A	85	85	77	63	43	36	17	10
	LS65.. A	85	85	80	65	55	40	17	10
4 Pole in Serie 	LS16.. A	16	16	16	16	16	16	16	16
	LS25.. A	25	25	25	25	25	25	25	25
	LS32.. A	32	32	32	32	32	32	32	32
	LS38.. A	45	45	-	-	-	-	-	-
	LS40.. A	48	48	40	40	40	40	40	40
	LS55.. A	55	55	55	55	55	55	55	55
	LS65.. A	65	65	65	65	65	65	65	65
4 Pole in Serie+2 parallel 	LS16.. A	29	29	29	29	29	29	29	20
	LS25.. A	45	45	45	45	45	45	45	26
	LS32.. A	58	58	58	58	58	58	50	32
	LS38.. A	-	-	-	-	-	-	-	-
	LS40.. A	72	72	72	72	72	72	56	42
	LS55.. A	85	85	85	85	85	85	65	55
	LS65.. A	85	85	85	85	85	85	65	55

Typ	6-polig	3+2-polig 3 Pole in Serie +2 Pole parallel	8-polig	4+2-polig 4 Pole in serie +2 Pole parallel
-----	---------	--	---------	--

LS16 ... LS65 ...A6 .. A3+2 ...A8 .. A4+2

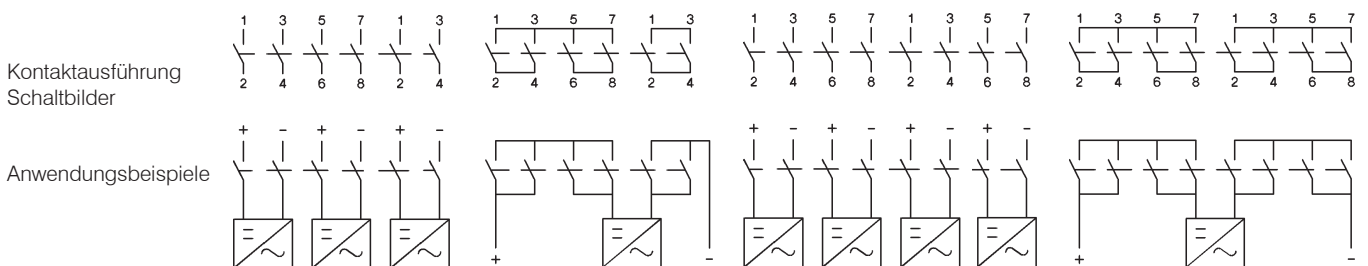

Isolierte Verbinder LSV.. für Serien- und Parallelschaltung von Kontakten siehe S. 325.



Ein-Aus-Schalter, Fronteinbau m. Vierlochbefestigung, Schild 64^q, Schutzart IP66, cUL^{us} Type 3R



DC21B / DC-PV1 600V DC 1000V DC	Anzahl Pole in Serie	Anzahl Strings	Typ	VPE Stk.	Gewicht kg/Stk.
16A 10A	2	1	LS16 E A2	1	0,20
25A 11,5A	2	1	LS25 E A2	1	0,20
32A 13A	2	1	LS32 E A2	1	0,20
45A 20A	2	1	LS38 E A2	1	0,20
48A 29A	2	1	LS40 E A2	1	0,41
55A 36A	2	1	LS55 E A2	1	0,41
65A 40A	2	1	LS65 E A2	1	0,41

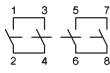

29A 10A	2	1	LS16 E A2+2	1	0,25
36A 11,5A	2	1	LS25 E A2+2	1	0,25
55A 13A	2	1	LS32 E A2+2	1	0,25
- 20A	2	1	LS38 E A2+2	1	0,25
68A 29A	2	1	LS40 E A2+2	1	0,54
85A 36A	2	1	LS55 E A2+2	1	0,54
85A 40A	2	1	LS65 E A2+2	1	0,54

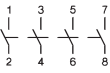

16A 10A	2	2	LS16 E A4	1	0,23
25A 11,5A	2	2	LS25 E A4	1	0,23
32A 13A	2	2	LS32 E A4	1	0,23
45A 20A	2	2	LS38 E A4	1	0,23
48A 29A	2	2	LS40 E A4	1	0,49
55A 36A	2	2	LS55 E A4	1	0,49
65A 40A	2	2	LS65 E A4	1	0,49

Typenzusatz

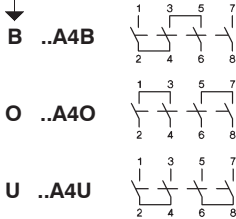

16A 16A	4	1	LS16 E A4.	1	0,24
25A 25A	4	1	LS25 E A4.	1	0,24
32A 32A	4	1	LS32 E A4.	1	0,24
45A -	4	1	LS38 E A4.	1	0,24
48A 40A	4	1	LS40 E A4.	1	0,52
55A 55A	4	1	LS55 E A4.	1	0,52
- -	4	1	LS65 E A4.	1	0,52

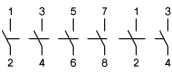

16A 10A	2	3	LS16 E A6	1	0,36
25A 11,5A	2	3	LS25 E A6	1	0,36
32A 13A	2	3	LS32 E A6	1	0,36
45A 20A	2	3	LS38 E A6	1	0,36
48A 29A	2	3	LS40 E A6	1	0,99
55A 36A	2	3	LS55 E A6	1	0,99
- -	2	3	LS65 E A6	1	0,99

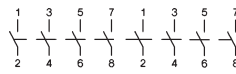

16A 10A	2	4	LS16 E A8	1	0,41
25A 11,5A	2	4	LS25 E A8	1	0,41
32A 13A	2	4	LS32 E A8	1	0,41
45A 20A	2	4	LS38 E A8	1	0,41
48A 29A	2	4	LS40 E A8	1	1,09
55A 36A	2	4	LS55 E A8	1	1,09
- -	2	4	LS65 E A8	1	1,09

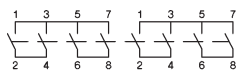

29A 29A	4	1	LS16 E A4+2	1	0,46
45A 45A	4	1	LS25 E A4+2	1	0,46
58A 58A	4	1	LS32 E A4+2	1	0,46
- -	4	1	LS38 E A4+2	1	0,46
72A 72A	4	1	LS40 E A4+2	1	1,20
85A 85A	4	1	LS55 E A4+2	1	1,20
85A 85A	4	1	LS65 E A4+2	1	1,20



Verlängerte Schalterwelle für Schalter für Fronteinbau

Typenzusatz

+VW"x"

x = Paneelstärke

Ein-Aus-Schalter, Zentralbefestigung Ø22mm, Schild 48[□], Schutzart IP66, c(UL)us Type 4X

	DC21B / DC-PV1		Anzahl Pole in Serie	Anzahl Strings	Typ	VPE Stk.	Gewicht kg/Stk.
	600V DC	1000V DC					
	1 3 2 4		2	1	LS16 Z A2	1	0,21
	1 3 5 7 2 4 6 8		2	1	LS25 Z A2	1	0,21
	1 3 5 7 2 4 6 8		2	1	LS32 Z A2	1	0,21
	1 3 5 7 2 4 6 8		2	1	LS38 Z A2	1	0,21
	1 3 5 7 2 4 6 8		2	1	LS16 Z A2+2	1	0,26
	1 3 5 7 2 4 6 8		2	1	LS25 Z A2+2	1	0,26
	1 3 5 7 2 4 6 8		2	1	LS32 Z A2+2	1	0,26
	1 3 5 7 2 4 6 8		2	1	LS38 Z A2+2	1	0,26
Typenzusatz ↓	1 3 5 7 2 4 6 8		2	2	LS16 Z A4	1	0,23
	1 3 5 7 2 4 6 8		2	2	LS25 Z A4	1	0,23
	1 3 5 7 2 4 6 8		2	2	LS32 Z A4	1	0,23
	1 3 5 7 2 4 6 8		2	2	LS38 Z A4	1	0,23
↓	1 3 5 7 2 4 6 8		4	1	LS16 Z A4.	1	0,25
	1 3 5 7 2 4 6 8		4	1	LS25 Z A4.	1	0,25
	1 3 5 7 2 4 6 8		4	1	LS32 Z A4.	1	0,25
	1 3 5 7 2 4 6 8		4	1	LS38 Z A4.	1	0,25
	1 3 5 7 1 3 2 4 6 8 2 4		2	3	LS16 Z A6	1	0,38
	1 3 5 7 1 3 2 4 6 8 2 4		2	3	LS25 Z A6	1	0,38
	1 3 5 7 1 3 2 4 6 8 2 4		2	3	LS32 Z A6	1	0,38
	1 3 5 7 1 3 2 4 6 8 2 4		2	3	LS38 Z A6	1	0,38
	1 3 5 7 1 3 2 4 6 8 2 4		2	4	LS16 Z A8	1	0,43
	1 3 5 7 1 3 2 4 6 8 2 4		2	4	LS25 Z A8	1	0,43
	1 3 5 7 1 3 2 4 6 8 2 4		2	4	LS32 Z A8	1	0,43
	1 3 5 7 1 3 2 4 6 8 2 4		2	4	LS38 Z A8	1	0,43
	1 3 5 7 1 3 2 4 6 8 2 4		4	1	LS16 Z A4+2	1	0,48
	1 3 5 7 1 3 2 4 6 8 2 4		4	1	LS25 Z A4+2	1	0,48
	1 3 5 7 1 3 2 4 6 8 2 4		4	1	LS32 Z A4+2	1	0,48
	1 3 5 7 1 3 2 4 6 8 2 4		4	1	LS38 Z A4+2	1	0,48

Ein-Aus-Schalter, Zentralbefestigung Ø22mm, ohne Schild, Schutzart IP66, c(UL)us Typ 4X

	bei Type „Z“ durch „ZO“ ersetzen	LS.. ZO A.
---	----------------------------------	-------------------

Ein-Aus-Schalter, Bodenmontage, Türkupplung für Zentralbefestigung, Schild 64⁰, IP66, cUL_{us} Type 4X



DC21B / DC-PV1 600V DC 1000V DC	Anzahl Pole in Serie	Anzahl Strings	Typ	VPE Stk.	Gewicht kg/Stk.
16A 10A	2	1	LS16 VZV A2	1	0,22
25A 11,5A	2	1	LS25 VZV A2	1	0,22
32A 13A	2	1	LS32 VZV A2	1	0,22
45A 20A	2	1	LS38 VZV A2	1	0,22
48A 29A	2	1	LS40 VZV A2	1	0,51
55A 36A	2	1	LS55 VZV A2	1	0,51
65A 40A	2	1	LS65 VZV A2	1	0,51

Einbautiefe einstellbar

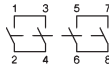

29A 10A	2	1	LS16 VZV A2+2	1	0,27
36A 11,5A	2	1	LS25 VZV A2+2	1	0,27
55A 13A	2	1	LS32 VZV A2+2	1	0,27
- 20A	2	1	LS38 VZV A2+2	1	0,27
68A 29A	2	1	LS40 VZV A2+2	1	0,55
85A 36A	2	1	LS55 VZV A2+2	1	0,55
85A 40A	2	1	LS65 VZV A2+2	1	0,55

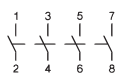

16A 10A	2	2	LS16 VZV A4	1	0,25
25A 11,5A	2	2	LS25 VZV A4	1	0,25
32A 13A	2	2	LS32 VZV A4	1	0,25
45A 20A	2	2	LS38 VZV A4	1	0,25
48A 29A	2	2	LS40 VZV A4	1	0,56
55A 36A	2	2	LS55 VZV A4	1	0,56
65A 40A	2	2	LS65 VZV A4	1	0,56

Typenzusatz

B ..A4B

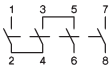

16A 16A	4	1	LS16 VZV A4.	1	0,26
25A 25A	4	1	LS25 VZV A4.	1	0,26
32A 32A	4	1	LS32 VZV A4.	1	0,26
45A -	4	1	LS38 VZV A4.	1	0,26
48A 40A	4	1	LS40 VZV A4.	1	0,58
55A 55A	4	1	LS55 VZV A4.	1	0,58
- -	4	1	LS65 VZV A4.	1	0,58

O ..A4O

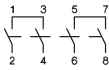

U ..A4U

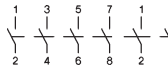
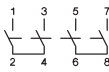

16A 10A	2	3	LS16 VZV A6	1	0,38
25A 11,5A	2	3	LS25 VZV A6	1	0,38
32A 13A	2	3	LS32 VZV A6	1	0,38
45A 20A	2	3	LS38 VZV A6	1	0,38
48A 29A	2	3	LS40 VZV A6	1	1,00
55A 36A	2	3	LS55 VZV A6	1	1,00
- -	2	3	LS65 VZV A6	1	1,00

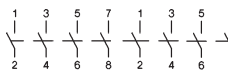

16A 10A	2	4	LS16 VZV A8	1	0,43
25A 11,5A	2	4	LS25 VZV A8	1	0,43
32A 13A	2	4	LS32 VZV A8	1	0,43
45A 20A	2	4	LS38 VZV A8	1	0,43
48A 29A	2	4	LS40 VZV A8	1	1,10
55A 36A	2	4	LS55 VZV A8	1	1,10
- -	2	4	LS65 VZV A8	1	1,10

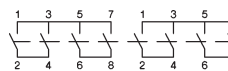

29A 29A	4	1	LS16 VZV A4+2	1	0,48
45A 45A	4	1	LS25 VZV A4+2	1	0,48
58A 58A	4	1	LS32 VZV A4+2	1	0,48
- -	4	1	LS38 VZV A4+2	1	0,48
72A 72A	4	1	LS40 VZV A4+2	1	1,21
85A 85A	4	1	LS55 VZV A4+2	1	1,21
85A 85A	4	1	LS65 VZV A4+2	1	1,21

Ein-Aus-Schalter, Reiheneinbau, Schutzart IP40, cULus Open Type



DDC21B / DC-PV1 600V DC 1000V DC		Anzahl Pole in Serie	Anzahl Strings	Typ	VPE Stk.	Gewicht kg/Stk.
16A	10A	2	1	LS16 SMA A2	1	0,19
25A	11,5A	2	1	LS25 SMA A2	1	0,19
32A	13A	2	1	LS32 SMA A2	1	0,19
45A	20A	2	1	LS38 SMA A2	1	0,19
48A	29A	2	1	LS40 SMA A2	1	0,41
55A	36A	2	1	LS55 SMA A2	1	0,41
65A	40A	2	1	LS65 SMA A2	1	0,41

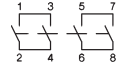

29A	10A	2	1	LS16 SMA A2+2	1	0,24
36A	11,5A	2	1	LS25 SMA A2+2	1	0,24
55A	13A	2	1	LS32 SMA A2+2	1	0,24
-	20A	2	1	LS38 SMA A2+2	1	0,24
68A	29A	2	1	LS40 SMA A2+2	1	0,52
85A	36A	2	1	LS55 SMA A2+2	1	0,52
85A	40A	2	1	LS65 SMA A2+2	1	0,52

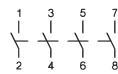

16A	10A	2	2	LS16 SMA A4	1	0,22
25A	11,5A	2	2	LS25 SMA A4	1	0,22
32A	13A	2	2	LS32 SMA A4	1	0,22
45A	20A	2	2	LS38 SMA A4	1	0,22
48A	29A	2	2	LS40 SMA A4	1	0,45
55A	36A	2	2	LS55 SMA A4	1	0,45
65A	40A	2	2	LS65 SMA A4	1	0,45

Typenzusatz

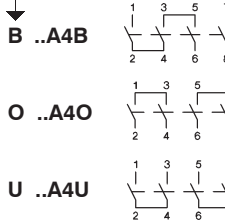

↓

16A	16A	4	1	LS16 SMA A4.	1	0,23
25A	25A	4	1	LS25 SMA A4.	1	0,23
32A	32A	4	1	LS32 SMA A4.	1	0,23
45A	-	4	1	LS32 SMA A4.	1	0,23
48A	40A	4	1	LS40 SMA A4.	1	0,49
55A	55A	4	1	LS55 SMA A4.	1	0,49
-	-	4	1	LS65 SMA A4.	1	0,49

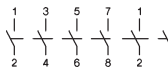

16A	10A	2	3	LS16 SMA A6	1	0,35
25A	11,5A	2	3	LS25 SMA A6	1	0,35
32A	13A	2	3	LS32 SMA A6	1	0,35
45A	20A	2	3	LS38 SMA A6	1	0,35
48A	29A	2	3	LS40 SMA A6	1	0,89
55A	36A	2	3	LS55 SMA A6	1	0,89
-	-	2	3	LS65 SMA A6	1	0,89

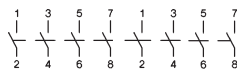

16A	10A	2	4	LS16 SMA A8	1	0,40
25A	11,5A	2	4	LS25 SMA A8	1	0,40
32A	13A	2	4	LS32 SMA A8	1	0,40
45A	20A	2	4	LS38 SMA A8	1	0,40
48A	29A	2	4	LS40 SMA A8	1	0,99
55A	36A	2	4	LS55 SMA A8	1	0,99
-	-	2	4	LS65 SMA A8	1	0,99

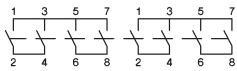

29A	29A	4	1	LS16 SMA A4+2	1	0,43
45A	45A	4	1	LS25 SMA A4+2	1	0,43
58A	58A	4	1	LS32 SMA A4+2	1	0,43
-	-	4	1	LS38 SMA A4+2	1	0,43
72A	72A	4	1	LS40 SMA A4+2	1	1,01
85A	85A	4	1	LS55 SMA A4+2	1	1,01
85A	85A	4	1	LS65 SMA A4+2	1	1,01

Hauptschalter, Fronteinbau m. Vierlochbefestigung, Schild 64[□], Schutzart IP66, Type 3R



Sperrvorrichtung SV4



DC21B / DC-PV1 600V DC 1000V DC	Anzahl Pole in Serie	Anzahl Strings	Typ	VPE Stk.	Gewicht kg/Stk.
16A 10A	2	1	LS16 EH4 A2	1	0,21
25A 11,5A	2	1	LS25 EH4 A2	1	0,21
32A 13A	2	1	LS32 EH4 A2	1	0,21
45A 20A	2	1	LS38 EH4 A2	1	0,21
48A 29A	2	1	LS40 EH4 A2	1	0,43
55A 36A	2	1	LS55 EH4 A2	1	0,43
65A 40A	2	1	LS65 EH4 A2	1	0,43

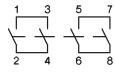

29A 10A	2	1	LS16 EH4 A2+2	1	0,26
36A 11,5A	2	1	LS25 EH4 A2+2	1	0,26
55A 13A	2	1	LS32 EH4 A2+2	1	0,26
- 20A	2	1	LS38 EH4 A2+2	1	0,26
68A 29A	2	1	LS40 EH4 A2+2	1	0,57
85A 36A	2	1	LS55 EH4 A2+2	1	0,57
85A 40A	2	1	LS65 EH4 A2+2	1	0,57

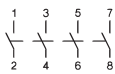

16A 10A	2	2	LS16 EH4 A4	1	0,24
25A 11,5A	2	2	LS25 EH4 A4	1	0,24
32A 13A	2	2	LS32 EH4 A4	1	0,24
45A 20A	2	2	LS38 EH4 A4	1	0,24
48A 29A	2	2	LS40 EH4 A4	1	0,50
55A 36A	2	2	LS55 EH4 A4	1	0,50
65A 40A	2	2	LS65 EH4 A4	1	0,50

Typenzusatz ↓

B ..A4B

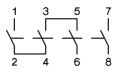

16A 16A	4	1	LS16 EH4 A4.	1	0,25
25A 25A	4	1	LS25 EH4 A4.	1	0,25
32A 32A	4	1	LS32 EH4 A4.	1	0,25
45A -	4	1	LS38 EH4 A4.	1	0,25
48A 40A	4	1	LS40 EH4 A4.	1	0,53
55A 55A	4	1	LS55 EH4 A4.	1	0,53
- -	4	1	LS65 EH4 A4.	1	0,53

O ..A4O

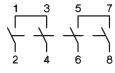

U ..A4U

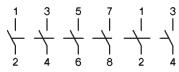
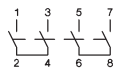

16A 10A	2	3	LS16 EH4 A6	1	0,37
25A 11,5A	2	3	LS25 EH4 A6	1	0,37
32A 13A	2	3	LS32 EH4 A6	1	0,37
45A 20A	2	3	LS38 EH4 A6	1	0,37
48A 29A	2	3	LS40 EH4 A6	1	0,53
55A 36A	2	3	LS55 EH4 A6	1	0,53
- -	2	3	LS65 EH4 A6	1	0,53

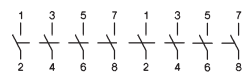

16A 10A	2	4	LS16 EH4 A8	1	0,42
25A 11,5A	2	4	LS25 EH4 A8	1	0,42
32A 13A	2	4	LS32 EH4 A8	1	0,42
45A 20A	2	4	LS38 EH4 A8	1	0,42
48A 29A	2	4	LS40 EH4 A8	1	1,10
55A 36A	2	4	LS55 EH4 A8	1	1,10
- -	2	4	LS65 EH4 A8	1	1,10

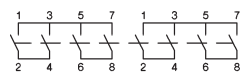

29A 29A	4	1	LS16 EH4 A4+2	1	0,47
45A 45A	4	1	LS25 EH4 A4+2	1	0,47
58A 58A	4	1	LS32 EH4 A4+2	1	0,47
- -	4	1	LS38 EH4 A4+2	1	0,47
72A 72A	4	1	LS40 EH4 A4+2	1	1,21
85A 85A	4	1	LS55 EH4 A4+2	1	1,21
85A 85A	4	1	LS65 EH4 A4+2	1	1,21



Verlängerte Schalterwelle für Schalter für Fronteinbau

Typenzusatz

+VW"x"

x = Paneelstärke

Hauptschalter, Zentralbefestigung Ø22mm, Schild 48[°], Schutzart IP66, Type 4X

	DC21B / DC-PV1		Anzahl Pole in Serie	Anzahl Strings	Typ	VPE Stk.	Gewicht kg/Stk.
	600V DC	1000V DC					
			2	1	LS16 ZH1 A2	1	0,21
			2	1	LS25 ZH1 A2	1	0,21
			2	1	LS32 ZH1 A2	1	0,21
			2	1	LS38 ZH1 A2	1	0,21
			2	1	LS16 ZH1 A2+2	1	0,27
Sperrvorrichtung SV1			2	1	LS25 ZH1 A2+2	1	0,27
			2	1	LS32 ZH1 A2+2	1	0,27
			2	1	LS38 ZH1 A2+2	1	0,27
			2	1	LS38 ZH1 A2+2	1	0,27
			2	2	LS16 ZH1 A4	1	0,24
			2	2	LS25 ZH1 A4	1	0,24
			2	2	LS32 ZH1 A4	1	0,24
			2	2	LS38 ZH1 A4	1	0,24
			2	2	LS38 ZH1 A4	1	0,24
Typenzusatz ↓ B ..A4B O ..A4O U ..A4U			4	1	LS16 ZH1 A4.	1	0,25
			4	1	LS25 ZH1 A4.	1	0,25
			4	1	LS32 ZH1 A4.	1	0,25
			4	1	LS38 ZH1 A4.	1	0,25
			4	1	LS38 ZH1 A4.	1	0,25
			2	3	LS16 ZH1 A6	1	0,39
			2	3	LS25 ZH1 A6	1	0,39
			2	3	LS32 ZH1 A6	1	0,39
			2	3	LS38 ZH1 A6	1	0,39
			2	4	LS16 ZH1 A8	1	0,44
			2	4	LS25 ZH1 A8	1	0,44
			2	4	LS32 ZH1 A8	1	0,44
			2	4	LS38 ZH1 A8	1	0,44
			4	1	LS16 ZH1 A4+2	1	0,49
			4	1	LS25 ZH1 A4+2	1	0,49
			4	1	LS32 ZH1 A4+2	1	0,49
			4	1	LS38 ZH1 A4+2	1	0,49

Hauptschalter, Zentralbefestigung Ø22mm, ohne Schild, Schutzart IP66, Type 4X

bei Type „ZH1“ durch „ZOH1“ ersetzen **LS.. ZOH1 A.**

Hauptschalter, Bodenmontage, Türkupplung für Zentralbefestigung, Schild 64², Schutzart IP66, Type 4X



DC21B / DC-PV1 600V DC 1000V DC	Anzahl Pole in Serie	Anzahl Strings	Typ	VPE Stk.	Gewicht kg/Stk.
16A 10A	2	1	LS16 VZVH4 A2	1	0,23
25A 11,5A	2	1	LS25 VZVH4 A2	1	0,23
32A 13A	2	1	LS32 VZVH4 A2	1	0,23
45A 20A	2	1	LS38 VZVH4 A2	1	0,23
48A 29A	2	1	LS40 VZVH4 A2	1	0,51
55A 36A	2	1	LS55 VZVH4 A2	1	0,51
65A 40A	2	1	LS65 VZVH4 A2	1	0,51

Einbautiefe einstellbar
siehe S. 322
Sperrvorrichtung SV4

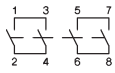

29A 10A	2	1	LS16 VZVH4 A2+2	1	0,28
36A 11,5A	2	1	LS25 VZVH4 A2+2	1	0,28
55A 13A	2	1	LS32 VZVH4 A2+2	1	0,28
- 20A	2	1	LS38 VZVH4 A2+2	1	0,28
68A 29A	2	1	LS40 VZVH4 A2+2	1	0,65
85A 36A	2	1	LS55 VZVH4 A2+2	1	0,65
85A 40A	2	1	LS65 VZVH4 A2+2	1	0,65

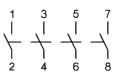

16A 10A	2	2	LS16 VZVH4 A4	1	0,26
25A 11,5A	2	2	LS25 VZVH4 A4	1	0,26
32A 13A	2	2	LS32 VZVH4 A4	1	0,26
45A 20A	2	2	LS38 VZVH4 A4	1	0,26
48A 29A	2	2	LS40 VZVH4 A4	1	0,58
55A 36A	2	2	LS55 VZVH4 A4	1	0,58
65A 40A	2	2	LS65 VZVH4 A4	1	0,58

Typenzusatz

B ..A4B

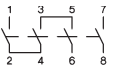

16A 16A	4	1	LS16 VZVH4 A4.	1	0,27
25A 25A	4	1	LS25 VZVH4 A4.	1	0,27
32A 32A	4	1	LS32 VZVH4 A4.	1	0,27
45A -	4	1	LS38 VZVH4 A4.	1	0,27
48A 40A	4	1	LS40 VZVH4 A4.	1	0,62
55A 55A	4	1	LS55 VZVH4 A4.	1	0,62
- -	4	1	LS65 VZVH4 A4.	1	0,62

O ..A4O

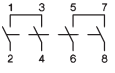

U ..A4U

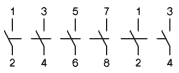
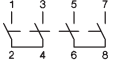

16A 10A	2	3	LS16 VZVH4 A6	1	0,39
25A 11,5A	2	3	LS25 VZVH4 A6	1	0,39
32A 13A	2	3	LS32 VZVH4 A6	1	0,39
45A 20A	2	3	LS38 VZVH4 A6	1	0,39
48A 29A	2	3	LS40 VZVH4 A6	1	1,00
55A 36A	2	3	LS55 VZVH4 A6	1	1,00
- -	2	3	LS65 VZVH4 A6	1	1,00

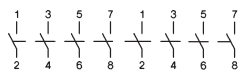

16A 10A	2	4	LS16 VZVH4 A8	1	0,44
25A 11,5A	2	4	LS25 VZVH4 A8	1	0,44
32A 13A	2	4	LS32 VZVH4 A8	1	0,44
45A 20A	2	4	LS38 VZVH4 A8	1	0,44
48A 29A	2	4	LS40 VZVH4 A8	1	1,11
55A 36A	2	4	LS55 VZVH4 A8	1	1,11
- -	2	4	LS65 VZVH4 A8	1	1,11

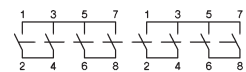

29A 29A	4	1	LS16 VZVH4 A4+2	1	0,49
45A 45A	4	1	LS25 VZVH4 A4+2	1	0,49
58A 58A	4	1	LS32 VZVH4 A4+2	1	0,49
- -	4	1	LS38 VZVH4 A4+2	1	0,49
72A 72A	4	1	LS40 VZVH4 A4+2	1	1,22
85A 85A	4	1	LS55 VZVH4 A4+2	1	1,22
85A 85A	4	1	LS65 VZVH4 A4+2	1	1,22

Hauptschalter, Reiheneinbau, versperribar, Schutzart IP40, Open Type



Sperrvorrichtung SV1



DC21B / DC-PV1 600V DC 1000V DC	Anzahl Pole in Serie	Anzahl Strings	Typ	VPE Stk.	Gewicht kg/Stk.
16A 10A	2	1	LS16 SMAH1 A2	1	0,19
25A 11,5A	2	1	LS25 SMAH1 A2	1	0,19
32A 13A	2	1	LS32 SMAH1 A2	1	0,19
45A 20A	2	1	LS38 SMAH1 A2	1	0,19
48A 29A	2	1	LS40 SMAH1 A2	1	0,40
55A 36A	2	1	LS55 SMAH1 A2	1	0,40
65A 40A	2	1	LS65 SMAH1 A2	1	0,40

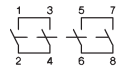

29A 10A	2	1	LS16 SMAH1 A2+2 ¹⁾	1	0,25
36A 11,5A	2	1	LS25 SMAH1 A2+2 ¹⁾	1	0,25
55A 13A	2	1	LS32 SMAH1 A2+2 ¹⁾	1	0,25
- 20A	2	1	LS38 SMAH1 A2+2 ¹⁾	1	0,25
68A 29A	2	1	LS40 SMAH1 A2+2	1	0,54
85A 36A	2	1	LS55 SMAH1 A2+2	1	0,54
85A 40A	2	1	LS65 SMAH1 A2+2	1	0,54

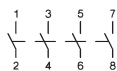

16A 10A	2	2	LS16 SMAH1 A4 ¹⁾	1	0,22
25A 11,5A	2	2	LS25 SMAH1 A4 ¹⁾	1	0,22
32A 13A	2	2	LS32 SMAH1 A4 ¹⁾	1	0,22
45A 20A	2	2	LS38 SMAH1 A4 ¹⁾	1	0,22
48A 29A	2	2	LS40 SMAH1 A4	1	0,47
55A 36A	2	2	LS55 SMAH1 A4	1	0,47
65A 40A	2	2	LS65 SMAH1 A4	1	0,47

Typenzusatz ↓

B ..A4B

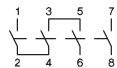

O ..A4O

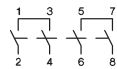

U ..A4U

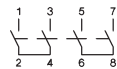

16A 16A	4	1	LS16 SMAH1 A4. ¹⁾	1	0,23
25A 25A	4	1	LS25 SMAH1 A4. ¹⁾	1	0,23
32A 32A	4	1	LS32 SMAH1 A4. ¹⁾	1	0,23
45A -	4	1	LS38 SMAH1 A4. ¹⁾	1	0,23
48A 40A	4	1	LS40 SMAH1 A4.	1	0,50
55A 55A	4	1	LS55 SMAH1 A4.	1	0,50
- -	4	1	LS65 SMAH1 A4.	1	0,50

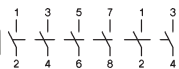

16A 10A	2	3	LS16 SMAH1 A6	1	0,36
25A 11,5A	2	3	LS25 SMAH1 A6	1	0,36
32A 13A	2	3	LS32 SMAH1 A6	1	0,36
45A 20A	2	3	LS38 SMAH1 A6	1	0,36
48A 29A	2	3	LS40 SMAH1 A6	1	0,90
55A 36A	2	3	LS55 SMAH1 A6	1	0,90
- -	2	3	LS65 SMAH1 A6	1	0,90

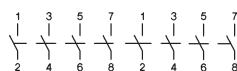

16A 10A	2	4	LS16 SMAH1 A8	1	0,41
25A 11,5A	2	4	LS25 SMAH1 A8	1	0,41
32A 13A	2	4	LS32 SMAH1 A8	1	0,41
45A 20A	2	4	LS38 SMAH1 A8	1	0,41
48A 29A	2	4	LS40 SMAH1 A8	1	0,41
55A 36A	2	4	LS55 SMAH1 A8	1	0,41
- -	2	4	LS65 SMAH1 A8	1	0,41

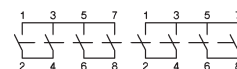

29A 29A	4	1	LS16 SMAH1 A4+2	1	0,46
45A 45A	4	1	LS25 SMAH1 A4+2	1	0,46
58A 58A	4	1	LS32 SMAH1 A4+2	1	0,46
- -	4	1	LS38 SMAH1 A4+2	1	0,46
72A 72A	4	1	LS40 SMAH1 A4+2	1	1,12
85A 85A	4	1	LS55 SMAH1 A4+2	1	1,12
85A 85A	4	1	LS55 SMAH1 A4+2	1	1,12

1) Hauptschalter, Reiheneinbau mit niedrigem Griff, versperribar, Schutzart IP40, Open Type

Typ mit Typenzusatz „+SV1N“ z.B.: **LS.. SMAH1 A2+2 +SV1N**

Hauptschalter, isolierstoffgekapselt, Schild 64[□], Schutzart IP66/67, Type 4X



DC21B / DC-PV1 600V DC 1000V DC	Anzahl Pole in Serie	Anzahl Strings	Typ	VPE Stk.	Gewicht kg/Stk.
16A 10A	2	1	LS16 PFLH4 A2	1	0,43
25A 11,5A	2	1	LS25 PFLH4 A2	1	0,43
32A 13A	2	1	LS32 PFLH4 A2	1	0,43
45A 20A	2	1	LS38 PFLH4 A2	1	0,43
48A 29A	2	1	LS40 PFLH4 A2 ¹⁾	1	1,59
55A 36A	2	1	LS55 PFLH4 A2 ¹⁾	1	1,59
65A 40A	2	1	LS65 PFLH4 A2 ¹⁾	1	1,59

Sperrvorrichtung SV4

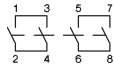

29A 10A	2	1	LS16 PFLH4 A2+2	1	0,49
36A 11,5A	2	1	LS25 PFLH4 A2+2	1	0,49
55A 13A	2	1	LS32 PFLH4 A2+2	1	0,49
- 20A	2	1	LS38 PFLH4 A2+2	1	0,49
68A 29A	2	1	LS40 PFLH4 A2+2 ¹⁾	1	1,74
85A 36A	2	1	LS55 PFLH4 A2+2 ¹⁾	1	1,74
85A 40A	2	1	LS65 PFLH4 A2+2 ¹⁾	1	1,74

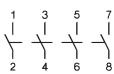

16A 10A	2	2	LS16 PFLH4 A4	1	0,46
25A 11,5A	2	2	LS25 PFLH4 A4	1	0,46
32A 13A	2	2	LS32 PFLH4 A4	1	0,46
45A 20A	2	2	LS38 PFLH4 A4	1	0,46
48A 29A	2	2	LS40 PFLH4 A4 ¹⁾	1	1,67
55A 36A	2	2	LS55 PFLH4 A4 ¹⁾	1	1,67
65A 40A	2	2	LS65 PFLH4 A4 ¹⁾	1	1,67

Typenzusatz



B ..A4B

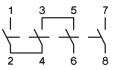

16A 16A	4	1	LS16 PFLH4 A4.	1	0,47
25A 25A	4	1	LS25 PFLH4 A4.	1	0,47
32A 32A	4	1	LS32 PFLH4 A4.	1	0,47

O ..A4O

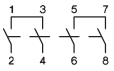

45A -	4	1	LS38 PFLH4 A4.	1	0,47
48A 40A	4	1	LS40 PFLH4 A4. ¹⁾	1	1,70

U ..A4U

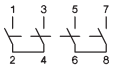

55A 55A	4	1	LS55 PFLH4 A4. ¹⁾	1	1,70
- -	4	1	LS65 PFLH4 A4. ¹⁾	1	1,70

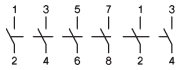

16A 10A	2	3	LS16 PFLH4 A6	1	1,53
25A 11,5A	2	3	LS25 PFLH4 A6	1	1,53
32A 13A	2	3	LS32 PFLH4 A6	1	1,53
45A 20A	2	3	LS38 PFLH4 A6	1	1,53
48A 29A	2	3	LS40 PFLH4 A6	1	1,87
55A 36A	2	3	LS55 PFLH4 A6	1	1,87
- -	2	3	LS65 PFLH4 A6	1	1,87

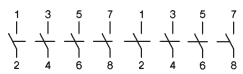

16A 10A	2	4	LS16 PFLH4 A8	1	1,58
25A 11,5A	2	4	LS25 PFLH4 A8	1	1,58
32A 13A	2	4	LS32 PFLH4 A8	1	1,58
45A 20A	2	4	LS38 PFLH4 A8	1	1,58
48A 29A	2	4	LS40 PFLH4 A8	1	1,94
55A 36A	2	4	LS55 PFLH4 A8	1	1,94
- -	2	4	LS65 PFLH4 A8	1	1,94

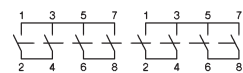

29A 29A	4	1	LS16 PFLH4 A4+2	1	1,63
45A 45A	4	1	LS25 PFLH4 A4+2	1	1,63
58A 58A	4	1	LS32 PFLH4 A4+2	1	1,63
- -	4	1	LS38 PFLH4 A4+2	1	1,63
72A 72A	4	1	LS40 PFLH4 A4+2	1	2,07
85A 85A	4	1	LS55 PFLH4 A4+2	1	2,07
85A 85A	4	1	LS65 PFLH4 A4+2	1	2,07

¹⁾ Kleines Kunststoffgehäuse: Artikel plus Suffix „+PF2“

z.B.: LS.. PFLH4 A2+2 +PF2 (Abmessungen siehe S. 325)

Technische Daten

Stromart	Gebrauchskategorie		Typische Anwendungsfälle	Prüfungsbedingungen für Elektrische Lebensdauer (Normale Beanspruchung)						Prüfungsbedingungen für Ein- und Ausschaltvermögen (Beanspruchung im Störungfall)					
				Einschalten		Ausschalten		L/R		Einschalten		Ausschalten		L/R	
	I/le	U/Ue	L/R	Ic/le	Ur/Ue	L/R	I/le	U/Ue	L/R	Ic/le	Ur/Ue	L/R			
Gleichstrom	DC21A häufige Betätigung	DC21B gelegentl. Betätigung	Schalten von ohmscher Last einschließlich geringer Überlast.	1	1	1ms	1	1	1ms	1,5	1,05	1ms	1,5	1,05	1ms
	DC22A häufige Betätigung	DC22B gelegentl. Betätigung	Schalten von gemischter ohmscher und induktiver Last einschließl. geringer Überlast.	1	1	2ms	1	1	2ms	4	1,05	2,5ms	4	1,05	2,5ms
	DC-PV1		Schalten eines einzelnen PV String(s) ohne Rück- und Überströme.	1	1	1ms	1	1	1ms	1,5	1,05	1ms	1,5	1,05	1ms
	DC-PV2		Schalten von mehreren PV Strings mit Rück- und Überströmen.	1	1	1ms	1	1	1ms	4	1,05	1ms	4	1,05	1ms

Daten nach IEC 60947-3, VDE 0660, GB/T14048.3 (CCC China)



Hauptkontakte		Typ	LS16	LS25	LS32	LS38	LS40	LS55		
Thermischer Bemessungsstrom I_{th}		A	16	25	32	45	48	55		
Bemessungsisolationsspannung $U_i^{(1)}$		V	1000	1000	1000	1000	1500	1500		
Bemessungsisolationsspannung $U_i^{(2)}$		V	1500	1500	1500	1500	1500	1500		
Kontaktabstand (pro Pol)		mm	8	8	8	8	8	8		
DC21A und DC21B	1 Pol	300V A	16	23	27	27	40	55		
		400V A	12/14	14/22	16/25	16/25	30/33	40/44		
		500V A	9/10	11/17	13/20	13/20	19/24	25/32		
		600V A	6/7	8/12	10/15	10/15	15/19	20/25		
		700V A	4,5/5	6/5	7,5	7,5	10/12	15/18		
		800V A	3	4	5	5	8/10	10/13		
		900V A	2,5/3	3	4	4	6/8	8/10		
		1000V A	1,5/2	2	2,5/3	2,5/3	4/5	6/8		
		nur DC21B	2 Pole in Serie A2	500V A	16	25	32	-/45	48	55
				600V A	16	25	32	-/45	48	55
700V A	16			23/25	27/32	-/36	35/37	55		
800V A	16/16			20	-/23	-/30	35	45/55		
900V A	13/16			16/17	-/20	-/25	25/31	35/43		
1000V A	9/10			11/11,5	13	-/20	25/29	-/36		
1200V A	6/7			8/8,5	10	10	10/11	15/17		
1500V A	3			4/5	5/6	-/6	6/8	7,5/10		
2 Pole in Serie + 2 Pole parallel A2+2	500V A			29	45	58	-/65	72	85	
	600V A			29	45	50/55		64/68	80/85	
	700V A	16/22	23/27	27/32		35/49	55/77			
	800V A	16/17	20	-/23	-/30	35/42	45/63			
	900V A	13/16	16/17	-/20		25/31	35/43			
	1000V A	9/10	11/11,5	13	-/20	23/29	25/36			
	1200V A	6/7	8/8,5	10		10/11	15/17			
	1500V A	3	4/5	5/6	-/6	6/8	7,5/10			
	3 Pole in Serie + 2 Pole parallel A3+2	500V A	29	45	58		72	85		
		600V A	29	45	50/58		72	85		
700V A		29	38/43	45/55		72	85			
800V A		29	38/40	-/51		68	85			
900V A		29	-/38	-/47		62	78			
1000V A		29	-/38	-/45		58	70			
1200V A		12	14/25	16/28						
1500V A		9	11/14	13/20						
4 Pole in Serie A4		500V A	16	25	32	-/45	48	55		
		600V A	16	25	32	-/45	48	55		
	700V A	16	25	32		40	55			
	800V A	16	25	32		40	55			
	900V A	16	25	32		40	55			
	1000V A	16	25	32	-/38	40	55			
	1200V A	16	25	32		40	55			
	1500V A	16	20/25	23/32	-/32	30/40	40/55			
	4 Pole in Serie + 2 Pole parallel A4+2	500V A	29	45	58	-/65	72	85		
		600V A	29	45	58		72	85		
700V A		29	45	-/58		72	85			
800V A		29	45	-/58		72	85			
900V A		29	45	-/58		72	85			
1000V A		29	-/45	-/58	-/65	-/72	-/85			
1200V A		29	-/45	50	-/50	-/56	-/65			
1500V A		16	20/26	23/32	-/32	-/42	-/55			
Bemessungsstrom I_e										
AC21B		A2, A4	U_e max. 440V	A	16	25	32	45	48	55
	A2+2	U_e max. 440V	A	29	45	58		72	85	

1) Gilt für: Überspannungskategorie I bis III, Verschmutzungsgrad 3 (Norm-Industrie): $U_{imp} = 8kV$.

2) Gilt für: Überspannungskategorie I bis III, Verschmutzungsgrad 2 (min. IP55): $U_{imp} = 8kV$.





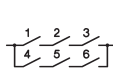
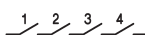
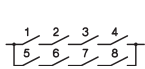

Technische Daten

Daten nach IEC 60947-3, VDE 0660

Hauptkontakte	Typ		LS16	LS25	LS32	LS38	LS40	LS55	LS65	
Bemessungsbetriebsstrom I_e										
DC-PV1 1 Pol A1 	300V	A	16	23	27	27	40	55	65	
	400V	A	14	22	25	25	33	44	50	
	500V	A	10	17	20	20	24	32	40	
	600V	A	7	12	15	15	19	25	30	
	700V	A	5	6	7,5	7,5	12	18	21	
	800V	A	3	4	5	5	10	13	15	
	900V	A	3	3	4	4	8	10	10	
	1000V	A	2	2	3	3	5	8	8	
	<hr/>									
	2 Pole in Serie A2 	500V	A	16	25	32	45	48	55	65
600V		A	16	25	32	45	48	55	65	
700V		A	16	25	32	36	37	55	65	
800V		A	16	20	23	30	35	55	65	
900V		A	16	17	20	25	31	43	55	
1000V		A	10	11,5	13	20	29	36	40	
1100V		A	8	10	11,5	-	19	25	-	
1200V		A	7	8,5	10	10	11	17	17	
1300V		A	6	7	8	-	10	14	-	
1400V		A	5	6	7	-	9	12	-	
1500V		A	3	5	6	6	8	10	10	
<hr/>										
2 Pole in Serie + 2 Pole parallel A2+2 		500V	A	29	45	58	65	72	85	85
	600V	A	29	45	55	58	68	85	85	
	700V	A	22	27	32	36	49	77	80	
	800V	A	17	20	23	30	42	63	65	
	900V	A	16	17	20	25	31	43	55	
	1000V	A	10	11,5	13	20	29	36	40	
	1100V	A	8	10	11,5	-	19	25	-	
	1200V	A	7	8,5	10	10	11	17	17	
	1300V	A	6	7	8	-	10	14	-	
	1400V	A	5	6	7	-	9	12	-	
	1500V	A	3	5	6	6	8	10	10	
	<hr/>									
	3 Pole in Serie + 2 Pole parallel A3+2 	500V	A	29	45	58	-	72	85	-
600V		A	29	45	58	-	72	85	-	
700V		A	29	43	55	-	72	85	-	
800V		A	29	40	51	-	68	85	-	
900V		A	29	38	47	-	62	78	-	
1000V		A	29	38	45	-	58	70	-	
1100V		A	19	27	37	-	-	-	-	
1200V		A	17	25	28	-	-	-	-	
1300V		A	15	21	25	-	-	-	-	
1400V		A	12	18	22	-	-	-	-	
1500V		A	10	14	20	-	-	-	-	
<hr/>										
4 Pole in Serie A4 		500V	A	16	25	32	45	48	55	65
	600V	A	16	25	32	45	48	55	65	
	700V	A	16	25	32	45	48	55	65	
	800V	A	16	25	32	45	48	55	65	
	900V	A	16	25	32	45	48	55	65	
	1000V	A	16	25	32	38	40	55	65	
	1100V	A	16	25	32	-	40	55	65	
	1200V	A	16	25	32	32	40	55	65	
	1300V	A	16	25	32	-	40	55	65	
	1400V	A	16	25	32	-	40	55	65	
	1500V	A	16	25	32	32	40	55	65	
	<hr/>									
	4 Pole in Serie + 2 Pole parallel A4+2 	500V	A	29	45	58	65	72	85	85
600V		A	29	45	58	65	72	85	85	
700V		A	29	45	58	65	72	85	85	
800V		A	29	45	58	65	72	85	85	
900V		A	29	45	58	65	72	85	85	
1000V		A	29	45	58	65	72	85	85	
1100V		A	29	45	54	-	60	68	-	
1200V		A	29	45	50	50	56	65	65	
1300V		A	26	39	44	-	50	61	-	
1400V		A	23	33	38	-	46	-	-	
1500V		A	20	26	32	32	42	55	55	

Technische Daten

Daten nach IEC 60947-3, VDE 0660

Hauptkontakte	Typ	LS16	LS25	LS32	LS38	LS40	LS55	LS65
Bemessungsbetriebsstrom I_e	300V A	16	23	27	27	40	55	-
DC-PV2	400V A	14	18	20	20	30	40	-
1 Pol	500V A	10	12	14	14	19	25	-
A1	600V A	5	6	8	8	10	13	-
	700V A	1,5	2	3	3	7	10	-
	800V A	1,5	2	3	3	6	8	-
	900V A	1	1,5	2	2	5	6	-
	1000V A	1	1,5	2	2	3	4	-
2 Pole in Serie	500V A	16	25	32	38	40	55	65
A2	600V A	14	21	27	31	40	55	65
	700V A	13	19	22	25	35	55	65
	800V A	12	15	17	19	33	49	52
	900V A	8	10	12	14	25	35	38
	1000V A	4	5	6	7	16	20	20
	1100V A	3	4	5	-	11	15	-
	1200V A	2	3	4	4	8	12	12
	1300V A	1,5	2	3	-	7	10	-
	1400V A	1	2	3	-	7	9	-
	1500V A	1	1,5	2	2	6	8	8
2 Pole in Serie + 2 Pole parallel	500V A	25	39	50	58	72	85	85
A2+2	600V A	20	32	35	38	33	49	75
	700V A	13	19	22	25	33	49	65
	800V A	12	15	17	19	33	49	52
	900V A	8	10	12	14	25	35	38
	1000V A	4	5	6	7	16	20	20
	1100V A	3	4	5	-	11	15	-
	1200V A	2	3	4	4	8	12	12
	1300V A	1,5	2	3	-	7	10	-
	1400V A	1	2	3	-	7	9	-
	1500V A	1	1,5	2	2	6	8	8
3 Pole in Serie + 2 Pole parallel	500V A	24	45	58	65	72	85	-
A3+2	600V A	22	34	44	48	78	-	-
	700V A	20	28	34	35	62	69	-
	800V A	18	24	29	31	53	61	-
	900V A	16	20	24	24	55	-	-
	1000V A	14	18	20	20	35	50	-
	1100V A	-	-	-	-	-	-	-
	1200V A	11	13	15	15	-	-	-
	1300V A	-	-	-	-	-	-	-
	1400V A	-	-	-	-	-	-	-
	1500V A	4	6	8	8	-	-	-
4 Pole in Serie	500V A	16	25	32	45	48	55	65
A4	600V A	16	25	32	45	48	55	65
	700V A	16	25	32	45	48	55	65
	800V A	16	25	32	38	40	55	65
	900V A	16	25	32	38	40	55	65
	1000V A	16	25	32	38	40	55	65
	1100V A	15	25	32	-	-	55	-
	1200V A	13,5	21	27	27	40	55	55
	1300V A	12	19	24	-	-	50	-
	1400V A	10,5	16	21	-	-	45	-
	1500V A	9	14	18	18	30	40	40
4 Pole in Serie + 2 Pole parallel	500V A	29	45	58	65	72	85	-
A4+2	600V A	29	45	58	65	72	85	-
	700V A	25	40	53	65	72	80	-
	800V A	21	35	45	60	67	75	-
	900V A	18	30	37	55	59	70	-
	1000V A	16	25	32	50	52	64	-
	1100V A	-	-	-	-	44	59	-
	1200V A	13,5	21	27	27	40	55	-
	1300V A	-	-	-	-	36	50	-
	1400V A	-	-	-	-	33	45	-
	1500V A	9	14	18	18	30	40	-

Schütze, Motorstarter

Leistungsschalter

Motorschutzschalter

Schalter

AC-Hauptschalter

DC-Laststromschalter

Befehls- und Meldegeräte

Vertretungen, Bezugsquellen



Technische Daten





Daten nach IEC 60947-3, VDE 0660

Hauptkontakte	Typ	LS16	LS25	LS32	LS38	LS40	LS55/LS65	
Bemessungsbetriebsstrom I_e	500V	A	1	1,25	1,5	x	x	2,5
DC22B	600V	A	0,5	0,75	1	x	x	2,0
1 Pol	800V	A	0,3	0,4	0,5	x	x	1,5
A1	1000V	A	0,15	0,2	0,25	x	x	1,0
<u>1</u>	1200V	A	-	-	-	x	x	x
	1500V	A	-	-	-	x	x	x
2 Pole in Serie	500V	A	7	8	9	x	x	x
A2	600V	A	5,5	6	6,5	x	x	x
1 2	800V	A	2	2,5	3	x	x	x
<u>1</u> <u>2</u>	1000V	A	1	1,5	2	x	x	x
	1200V	A	-	-	-	x	x	x
	1500V	A	-	-	-	x	x	x
4 Pole in Serie	500V	A	16	25	32	x	x	x
A4	600V	A	16	25	27,5	x	x	x
1 2 3 4	800V	A	11,5	12	12,5	x	x	x
<u>1</u> <u>2</u> <u>3</u> <u>4</u>	1000V	A	8	9	10	x	x	x
	1200V	A	-	-	-	x	x	x
	1500V	A	-	-	-	x	x	x
Bedingter Bemessungskurzschlußstrom	kA _{eff}	A	5	5	5	5	10	10
Maximale Vorsicherung	gL (gG)	A	40	63	80	80	125	160
Mechanische Lebensdauer	x10 ³		10	10	10	10	10	10
Bemessungskurzzeitstromfestigkeit (1s)	I _{cw} A2, A4, A6, A8 A2+2, A3+2, A4+2	A	800 1300	900 1500	1000 1700	1000 1700	A2, A4: 1200 A2+2: 2000	A2, A4: 1400 A2+2: 2400
Bemessungskurzschlußeinschaltvermögen	I _{cm} A2, A4, A6, A8 A2+2, A3+2, A4+2	A	800 1300	900 1500	1000 1700	1000 1700	A2, A4: 1200 A2+2: 2000	A2, A4: 1400 A2+2: 2400
Anschlußquerschnitte (inkl. Verbinder)			LSV-B1	LSV-B1	LSV-B1	LSV-B1	LSV-B2	LSV-B2
ein- oder mehrdrähtig	mm ²		4 - 16	4 - 16	4 - 16	4-16	2,5 - 25	2,5 - 25
feindrähtig	mm ²		4 - 10	4 - 10	4 - 10	4-10	2,5 - 16	2,5 - 16
feindrähtig (+ Aderendhülse)	mm ²		4 - 10	4 - 10	4 - 10	4-10	1,5 - 16	1,5 - 16
Klemmschraube			M4 Pz2	M4 Pz2	M4 Pz2	M4 Pz2	M5 Pz2	M5 Pz2
Anzugsdrehmoment	Nm		1,8 - 2	1,8 - 2	1,8 - 2	1,8 - 2	2,5 - 2,8	2,5 - 2,8
2 Leiter pro Klemme ohne Verbinder LSV-B1 / LSV-B2								
ein- oder mehrdrähtig	mm ²		16+(1,5-2,5) / 10+(1,5-6) / 6+(1,5-10) / 4+(1,5-10)			16+(1,5-2,5) / 10+(1,5-10) / 6+(1,5-10) / 4+(1,5-10)		
feindrähtig & feindrähtig + Aderendhülse	mm ²		16+(1,5-2,5) / 10+(1,5-4) / 6+(1,5-6)			16+(1,5-6) / 10+(1,5-10) / 6+(1,5-16) / 4+(1,5-16)		
stranded	AWG		8+(16-12) / 10+(16-10) / 12+(16-8) 14+(16-8)			3+(18-10) / 4+(18-10) / 6+(18-8) 8+(18-8)		
solid	AWG		10+(16-12) / 12+(16-10) 14+(16-10)			10+(16-10) / 12+(16-10) / 14+(16-10) 12+(16-10) / 14+(16-10)		
Zulässige Umgebungstemperatur								
Betrieb	offen	°C	-40 to +65					
	gekapselt	°C	-40 to +45					
Lagerung		°C	-50 to +90					
Verlustleistung pro Schalter bei I _e max.			A	A	A		A	A
A2	(A)/W	(16)/ 1	(25)/ 2,3	(32)/ 3,7		(40)/ 4	(55)/ 7,5	
A4	(A)/W	(16)/ 2	(25)/ 4,6	(32)/ 7,4		(40)/ 8	(55)/ 15	
A6	(A)/W	(16)/ 3	(25)/ 6,9	(32)/ 11,1		(40)/ 12	(55)/ 22,5	
A8	(A)/W	(16)/ 4	(25)/ 9,2	(32)/ 14,8		(40)/ 16	(55)/ 30	
A2+2	(A)/W	(29)/1,5	(45)/ 3,7	(58)/ 6		(72)/ 6,5	(85)/ 9	
A3+2	(A)/W	(29)/2,3	(45)/ 5,6	(58)/ 9		(72)/ 9,8	(85)/ 14	
A4+2	(A)/W	(29)/3	(45)/ 7,4	(58)/ 12		(72)/ 13	(85)/ 18	
Kontaktwiderstand pro Po	mΩ		1,75	1,75	1,75		1,25	1,25

x zur Approbation eingereicht



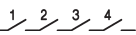
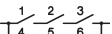
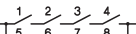

Technische Daten

Daten nach UL508I  File E359344 Category np.: NMSJ, und UL508 c  File E332938, Category no.: NRNT2, NRNT8

Typ				LS16	LS25	LS32	LS38	LS40	LS55	LS65		
Ampere-Rating "General use"  1 Pol	DC	350V	A	4	5	6	6	7,1	10,0	10,0		
		500V	A	4	5	6	6	5,7	7,0	7,0		
		600V	A	4	5	6	6	5,0	5,8	5,8		
		700V	A	-	-	-	-	3,9	5,0	5,0		
		800V	A	-	-	-	-	3,2	4,4	4,4		
		900V	A	-	-	-	-	2,5	3,5	3,5		
		1000V	A	-	-	-	-	1,5	2,0	2,0		
		 2 Pole in Serie A2	350V	A	16	25	32	38	40	55	65	
			500V	A	16	25	32	38	40	55	65	
			600V	A	16	25	32	36	40	55	65	
700V	A		-	-	-	-	32	46	50			
800V	A		-	-	-	-	26	37	40			
900V	A		-	-	-	-	20	28	32			
1000V	A		-	-	-	-	16	20	25			
 2 Pole in Serie + 2 Pole parallel A2+2	350V		A	29	45	58	58	72	85	85		
	400V		A	-	-	-	-	67	79	82		
	500V		A	29	38	40	45	53	66	73		
	600V	A	21	27	32	36	42	55	65			
	700V	A	-	-	-	-	35	47	50			
	800V	A	-	-	-	-	30	40	40			
	900V	A	-	-	-	-	26	32	32			
	1000V	A	-	-	-	-	22	25	23			
	 4 Pole in Serie A4	350V	A	16	25	32	38	40	55	65		
		500V	A	16	25	32	38	40	55	65		
600V		A	16	25	32	36	40	55	65			
700V		A	-	-	-	-	40	55	65			
800V		A	-	-	-	-	40	55	65			
900V		A	-	-	-	-	40	55	65			
1000V		A	-	-	-	-	40	55	65			
 3 Pole in Serie + 2 Pole parallel A3+2		350V	A	29	45	58	58	72	85	85		
		500V	A	29	38	50	50	56	80	85		
		600V	A	21	38	45	45	52	65	72		
	700V	A	-	-	-	-	46	58	66			
	800V	A	-	-	-	-	40	51	60			
	900V	A	-	-	-	-	36	45	54			
	1000V	A	-	-	-	-	33	42	48			
	 4 Pole in Serie + 2 Pole parallel A4+2	350V	A	29	45	58	58	80	85	85		
		500V	A	29	45	58	58	71	85	85		
		600V	A	29	45	50	50	65	85	85		
700V		A	-	-	-	-	58	76	85			
800V		A	-	-	-	-	51	71	76			
900V		A	-	-	-	-	45	67	73			
1000V		A	-	-	-	-	42	64	70			
AC-Rating "General use"												
2 Pole in Serie			1 phasig	600V	A	16	25	32	-	40	55	-
2 Pole in Serie + 2 Pole parallel			1 phasig	277V	A	-	-	50	-	72	85	-
3 Pole parallel		3 phasig	480V	A	-	-	32	-	40	55	-	
Fuse size (RK5) Industrial Control Switch												
5kA / 600V				A	40	60	80	80	-	-	-	
5kA/1000V				A	-	-	-	-	160	160	160	
Max. Anschlußquerschnitte inkl. Verbinder LSV-B1 / LSV-B2												
eindrätig				AWG	12 - 10	12 - 10	12 - 10	12 - 10	16 - 10	16 - 10		
feindrätig + mehrdrätig				AWG	12 - 6	12 - 6	12 - 6	12 - 6	14 - 3	14 - 3		
feindrätig (+ Aderendhülse)				AWG	12 - 6	12 - 6	12 - 6	12 - 6	14 - 4	14 - 4		
Klemmschraube					M4 Pz2	M4 Pz2	M4 Pz2	M4 Pz2	M5 Pz2	M5 Pz2		
Anzugsdrehmoment				Nm	1,8 - 2	1,8 - 2	1,8 - 2	1,8 - 2	2,5 - 2,8	2,5 - 2,8		
Schutzart der Anschlußklemmen ¹⁾					IP20	IP20	IP20	IP20	IP20	IP20		

1) Schutzart der Anschlußklemmen mit angeschlossenen, isolierten Leitern.

Approbationen

Land	USA, UL508I	US, Kanada UL508	Europa	China CCC	CB- Zertifikate	EAC
Type						
LS16	o	o	/	o	o	o
LS25	o	o	/	o	o	o
LS32	o	o	/	o	o	o
LS38	o	o	/	o	o	o
LS40, LS55	o	o	/	o	o	o
LS65	o	o	/	-	o	o

o In Normalausführung approbiert / Approbation nicht erforderlich CE x zur Approbation eingereicht - nicht zur Approbation vorgesehen

Technische Daten

Beispiele für maximal zulässige Ströme, abhängig von Umgebungstemperaturen und Anschlußquerschnitten:

Schalter **offen** LS16..., 2 Kontakte in Serie (A2)

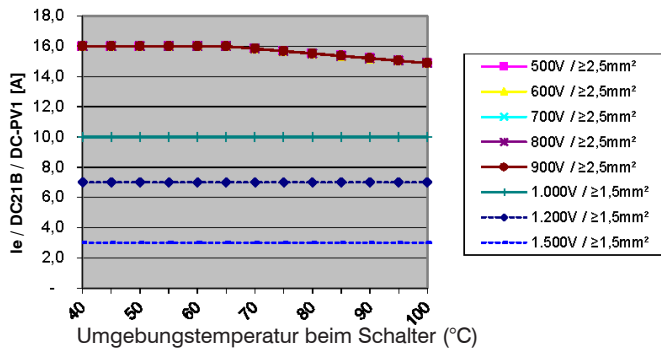

Schalter **offen** LS16 ..., 2 Kontakte in Serie + 2 parallel (A2+2)

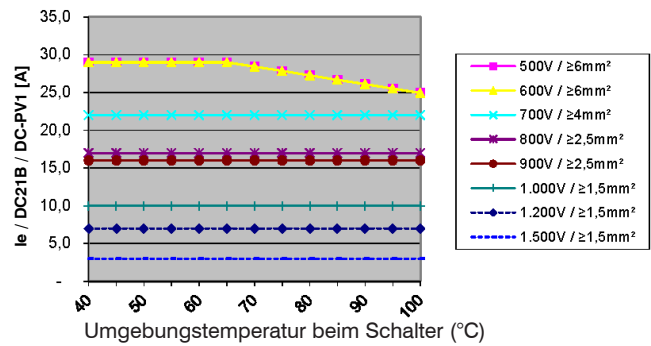

Schalter **gekapselt** LS16 PFL..., 2 Kontakte in Serie (A2)

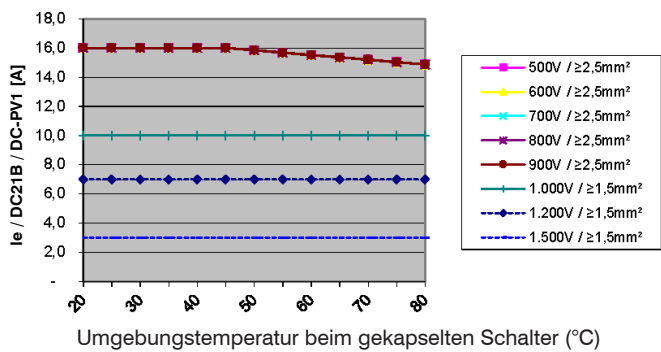

Schalter **gekapselt** LS16 PFL..., 2 Kontakte in Serie + 2 parallel (A2+2)

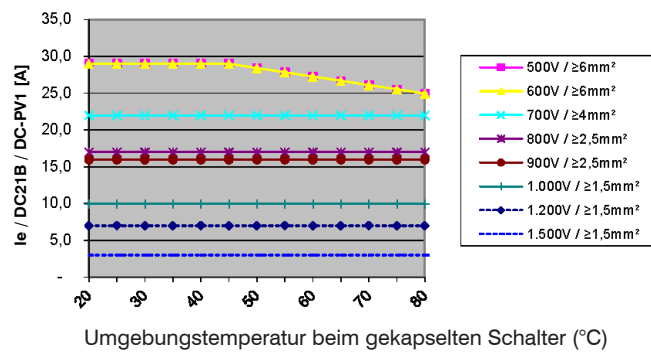

Aktuelle Daten über sämtliche maximal zulässigen Ströme abhängig von Umgebungstemperaturen für Schalter LS16.. bis LS65.. (offen oder gekapselt) siehe ➡ www.benedict.at (Button "Kunden").

Abmessungen

LS16 E.., LS25 E.., LS32 E.., LS38E.., ..A2

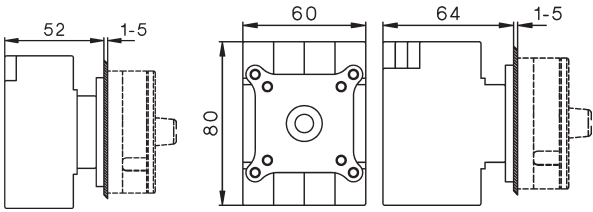

LS16 E.., LS25 E.., LS32 E.., LS38E.., ..A6, ..A8, ..A3+2, ..A4+2

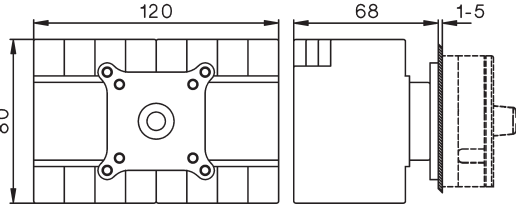

LS... +VW"x"
Verlängerte Schalterwelle

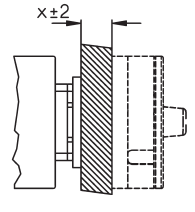

LS40 E.., LS55 E.., LS65 E.. ..A2, ..A2+2, ..A4

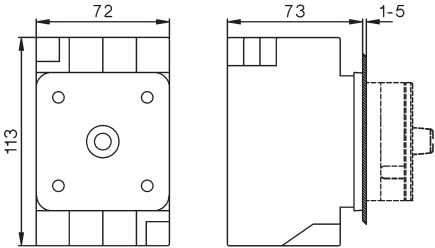

LS40 E.., LS55 E.., LS65 E.. ..A6, ..A8, ..A3+2, ..A4+2

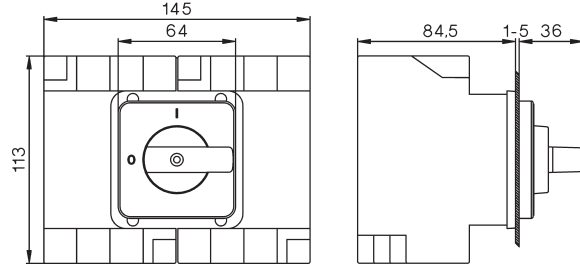

Bohrplan
Montageschraube
S3631N M=1,2-1,4 Nm

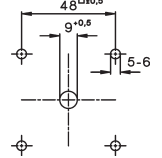

Schild 64[□]
Griff

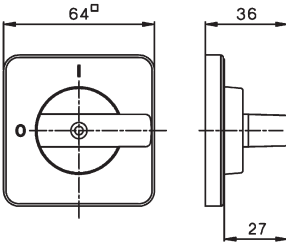

Sperrvorrichtung SV1

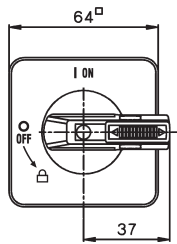

Sperrvorrichtung SV4

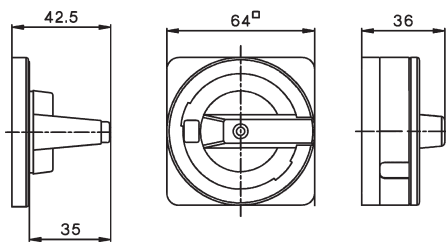

LS16 Z.., LS25 Z.., LS32 Z.., LS38Z.., ..A2

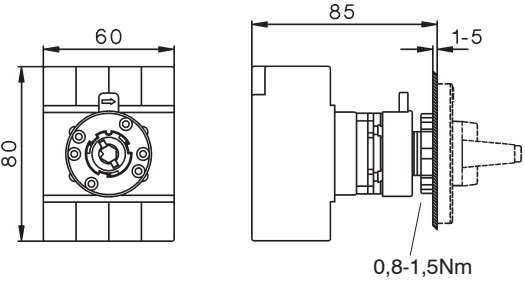

..A2+2, ..A4

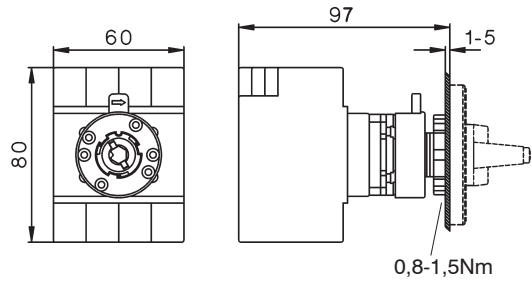

Bohrplan

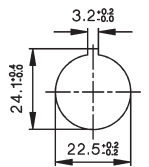

Schild 48[□]
Griff

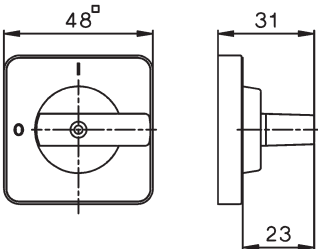

Sperrvorrichtung SV1

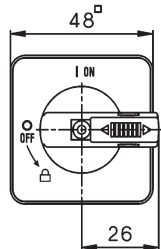

Abmessungen

LS16 Z., LS25 Z., LS32 Z., LS38 Z.,
..A6, ..A8, ..A3+2, ..A4+2

LS.. ZO..

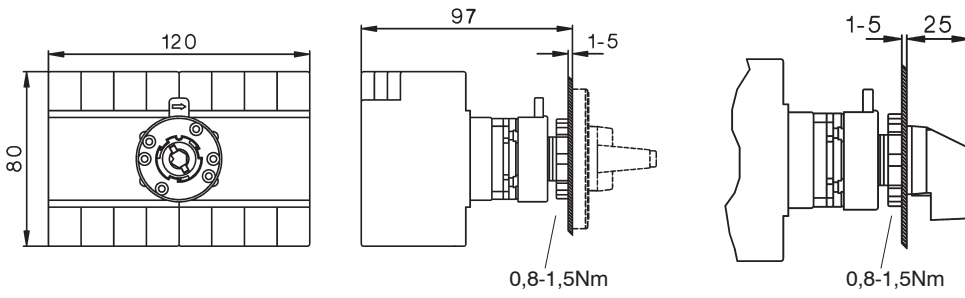

LS16 VZV., LS25 VZV., LS32 VZV., LS38 VZV.,
..A2, ..A2+2, ..A4

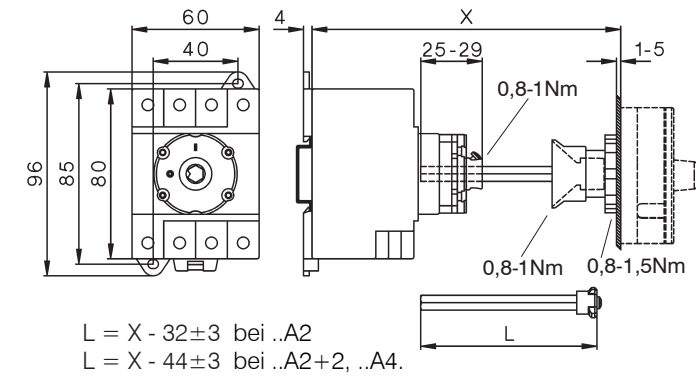

Lieferlänge bei: ..A2
 $X_{max.} = 182, L = 150$
 ($X_{min.} = 77$)

Lieferlänge bei: ..A2+2, ..A4.
 $X_{max.} = 194, L = 150$
 ($X_{min.} = 89$)

größere X-Maße auf Anfrage

LS16 VZV., LS25 VZV., LS32 VZV., LS38 VZV.,
..A6, ..A8, ..A3+2, ..A4+2

Bohrplan

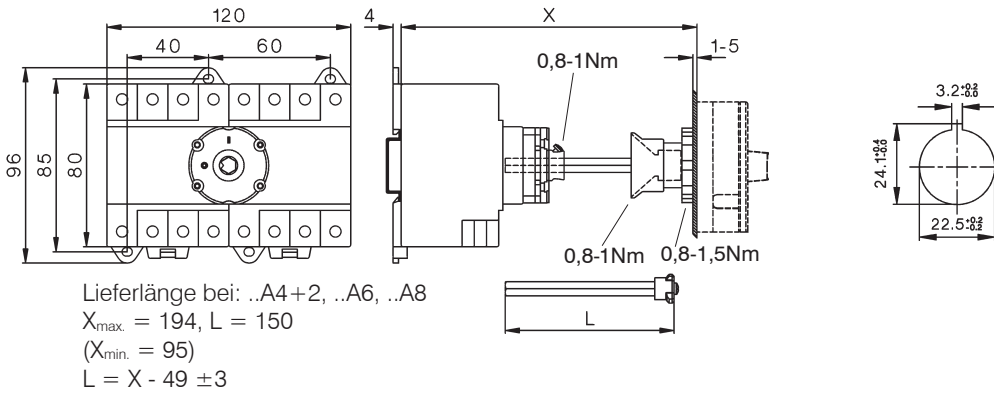

LS40 VZV., LS55 VZV., LS65 VZV..
..A2, ..A2+2, ..A4

LS40 VZV., LS55 VZV., LS65 VZV..
..A6, ..A8, ..A3+2, ..A4+2

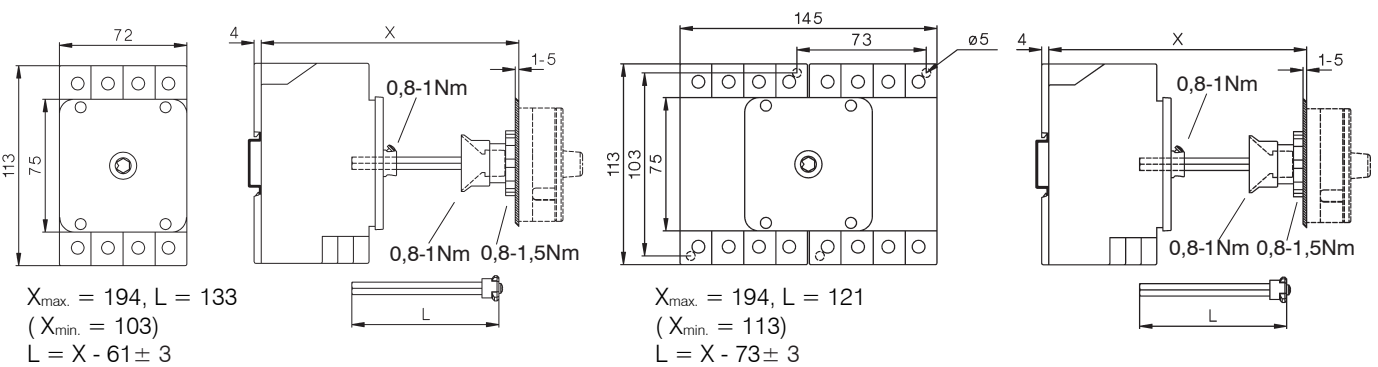

Abmessungen

LS16 SMA..., LS25 SMA..., LS32 SMA..., LS38 SMA...,
..A2 ..

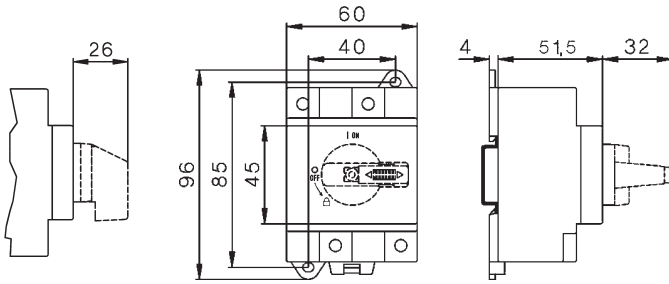

A2+2, ..A4

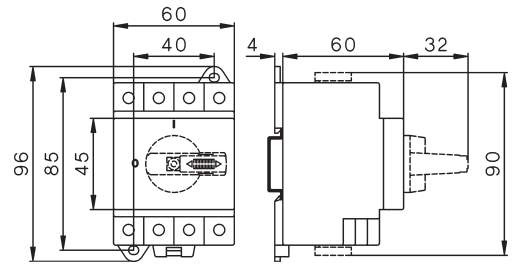

LS40 SMA..., LS55 SMA..., LS65 SMA..
..A2, ..A2+2, ..A4

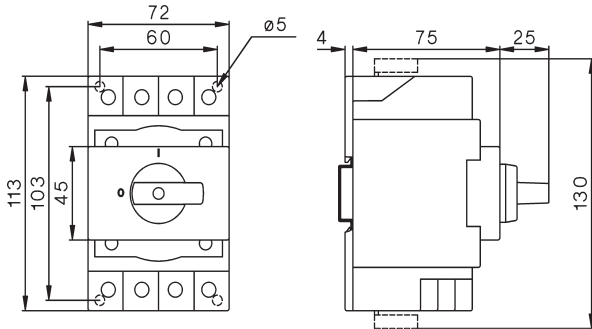

LS40 SMA..., LS55 SMA..., LS65 SMA..
..A6, ..A8, ..A3+2, ..A4+2

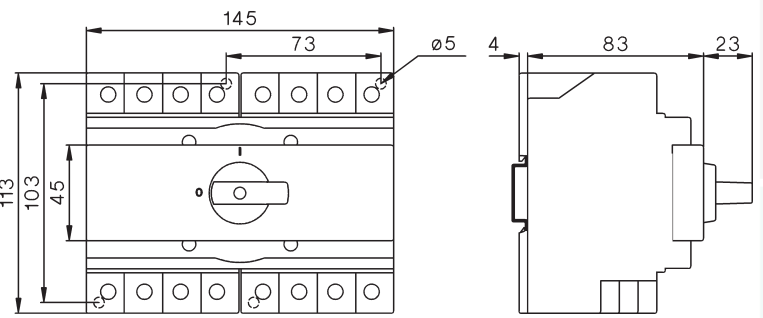

LS16 SMA..., LS25 SMA..., LS32 SMA..., LS38 SMA...,
..A6, ..A8, ..A3+2, ..A4+2

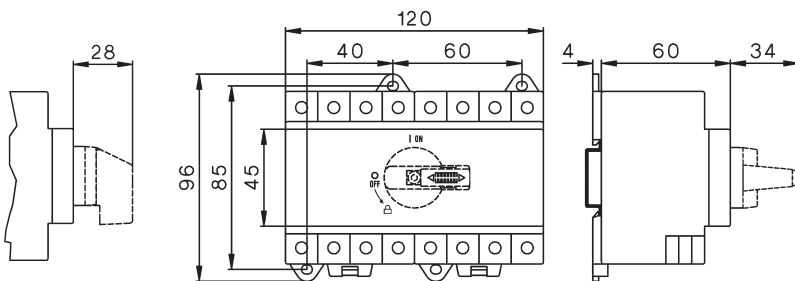

LS.. SMAH1.. mit niedrigem Griff
A2 +SV1N

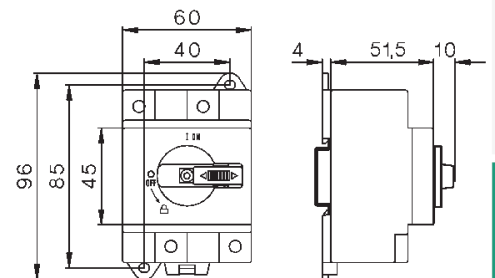

LS16 SMAH1..., LS25 SMAH1..., LS32 SMAH1..., LS38 SMAH1..
A2+2 +SV1N, A4 +SV1N mit niedrigem Griff

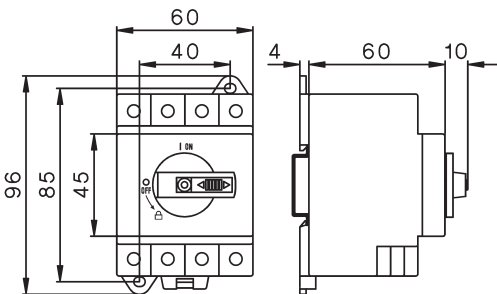

mit niedrigem Griff
A4+2 +SV1N, A6 +SV1N, A8 +SV1N

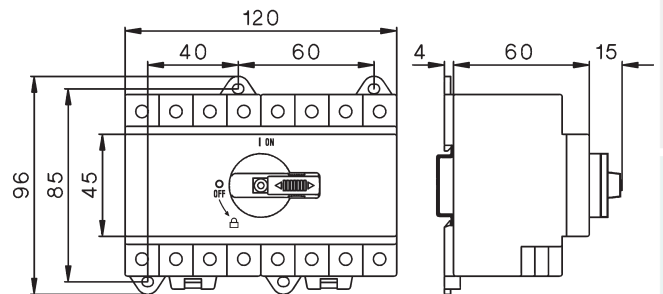

Abmessungen:

LS16 PFL..., LS25 PFL..., LS32 PFL..., LS38 PFL..
..A2, ..A2+2, ..A4.

Hauptschalter (versperrbar)
LS..PFLH4 A..

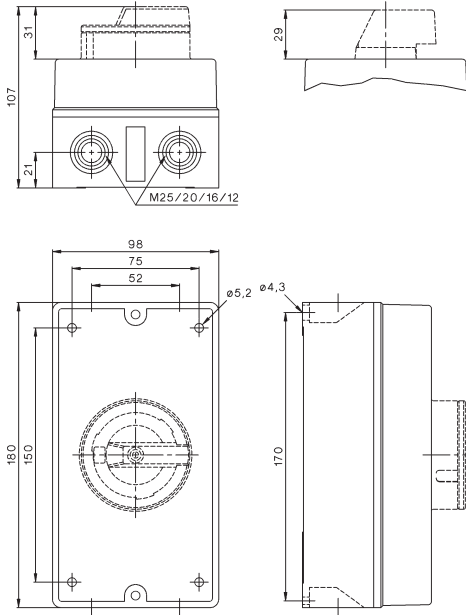

LS16 PFL..., LS25 PFL..., LS32 PFL..., LS38 PFL..
..A2, ..A2+2, ..A4.
+ M25

Hauptschalter (versperrbar)
LS..PFLH4 A..

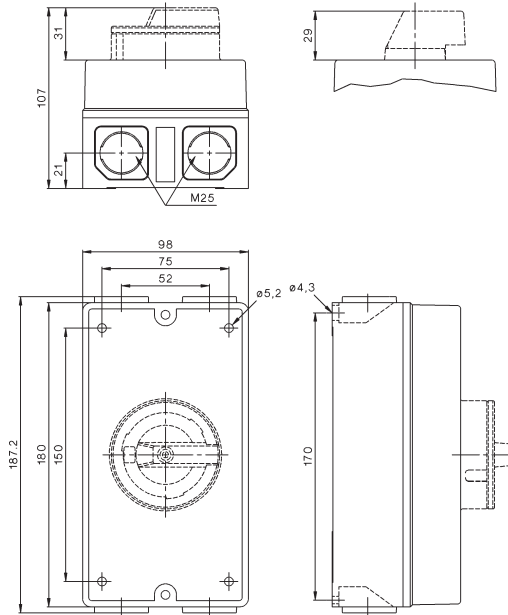

LS16 PFL..., LS25 PFL..., LS32 PFL..., LS38 PFL..
..A2, ..A4, ..A6, ..A8, ..A2+2, ..A3+2, ..A4+2
LS40 PFL..., LS55 PFL..., LS65 PFL..
..A6, ..A8, ..A3+2, ..A4+2

Hauptschalter (versperrbar)
LS..PFLH4 A..

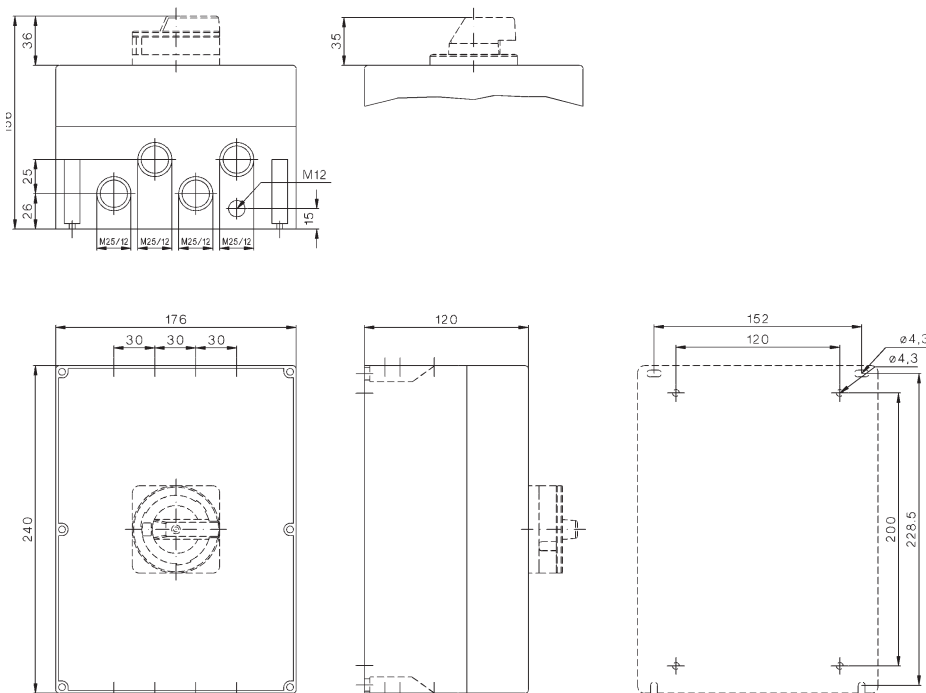

Abmessungen:

LS40 PFL..., LS55 PFL..., LS65 PFL..
..A2, ..A4, ..A2+2





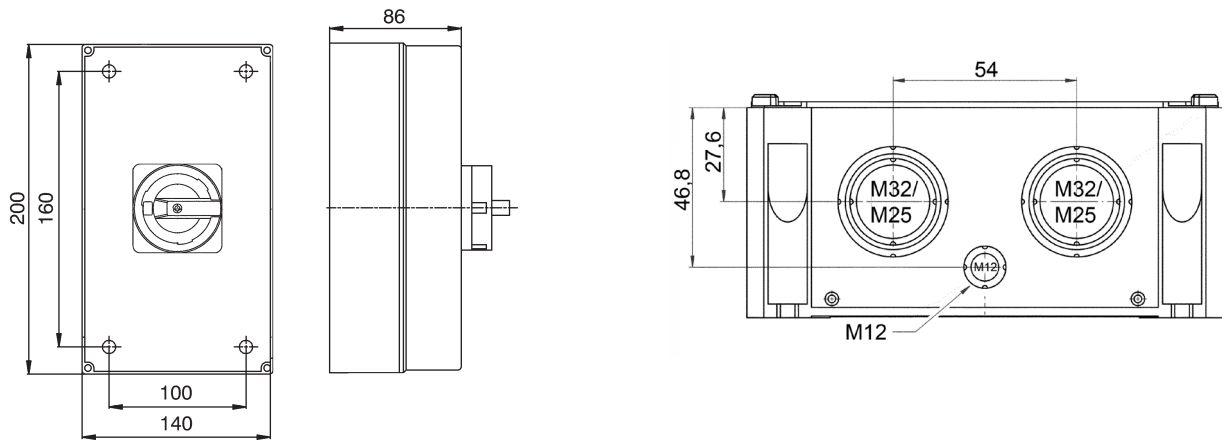



Hauptschalter (versperrbar)

LS..PFLH4 A.. +PF2 (Gehäuse klein)



Isolierte Verbinder LSV-.. für Serien- und Parallelschaltung von Kontakten:

Passend auf Schalter	Verbinder-Typ	VPE	Gewicht
LS16, LS25, LS32, LS38	LSV-B1-1	100	7,0 g/Stk.
LS16, LS25, LS32, LS38	LSV-B1-2	100	12,0 g/Stk.
LS40, LS55, LS65	LSV-B2-1	100	9,0 g/Stk.
LS40, LS55, LS65	LSV-B2-2	100	17,0 g/Stk.

Typ	LS16	LS25	LS32	LS38	LS40	LS55	LS65
A40 A4U A4B	2 x  LSV-B1-1		2 x  LSV-B1-2		2 x  LSV-B2-2		
A2+2	4 x  LSV-B1-1				4 x  LSV-B2-1		
A4+2	8 x  LSV-B1-1				8 x  LSV-B2-1		
	2 x  LSV-B1-2				2 x  LSV-B2-2		

Anwendungsbeispiele:

LS16-38 VZV.. A2+2

LS16-32 VZV.. A40

LS38 VZV.. A40

LS16-38 VZV.. A4+2

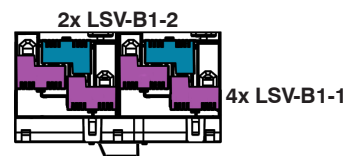
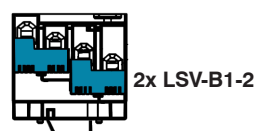
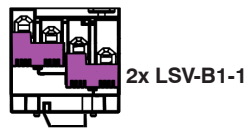
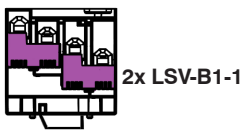
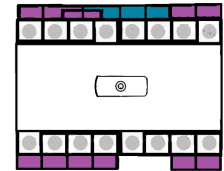
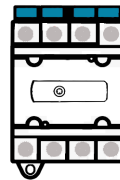
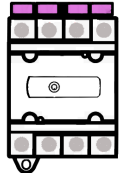
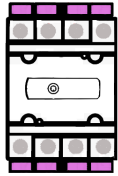
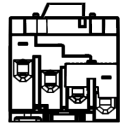

LS40-65 VZV.. A2+2

LS40-65 VZV.. A40

LS40-65 VZV.. A4+2

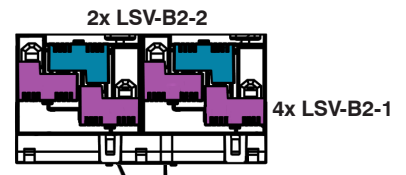
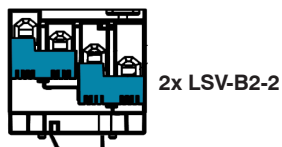
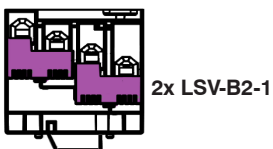
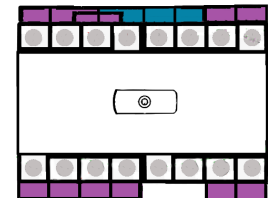
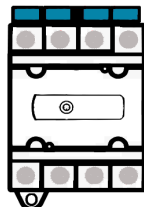
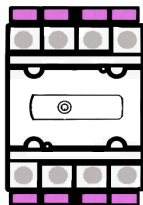
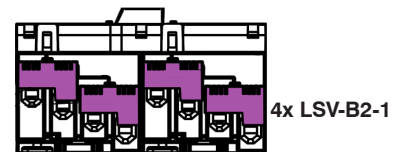

Weitere Anwendungsbeispiele für Schalter LS16.. bis LS65.. siehe www.benedict.at (Button "Kunden").