

# General Catalogue



Quality made in



D946E261



**Contactors, Motor-Starter**

	3
Micro Contactors	11
Mini Contactors	25
Contactor Relays	39
Contactors	45
Starters	91
D.O.L. Starters	111
Overload Relays	119
Modular Contactors	133
Contactors for DC-Switching (D911E)	141
Contactors RAST 5 (D778E)	145



**Circuit Breakers**

	165
Circuit-Breakers M4 for motor protection	166
Auxiliary contacts, Signalling switch, Auxiliary releases	167
Insulated 3-pole busbar system, Terminal block	168
DIN-rail adapters, Busbar adapters	169
Link modules, Contactors for Circuit-Breakers M4	171



**Manual Motor-Starters**

	187
Manual Motor-Starters, Auxiliary Contact Blocks	188
Trip Alarm Aux. Switch, Shunt Release	188
Under-voltage Release, Accessories	189
Busbar Connectors, Enclosures	189



**Switches**

	193
Cam Switches	198
Mini-Cam Switches	236
Load switches	240
Handles and plates	242
Optional Extras	249
Special Switches	257



**AC-Main Switches**

	277
Main Switches for Panel Mounting	280
Main Switches for Base Mounting with Door Clutch	282
Main Switches-Emergency-Stop for Panel Mounting	286
Changeover Switches for Panel Mounting	287
Main Switches-Emergency-Stop for Single Hole Mounting	287
Main Switches-Emergency-Stop for Base Mounting with Door Clutch	288
Main Switches-Emergency-Stop for Distribution Boards	290
Changeover Switches-Emergency-Stop for Panel Mounting	290
Maintenance and Safety Switches, in Plastic Enclosures	291
Changeover Switches, in Plastic Enclosures	291
Switch Disconnectors for Panel Mounting	292
Switch Disconnectors for Distribution Boards	295
Switch Disconnectors in Plastic Enclosures	296
Add-on modules	297



**DC Switch Disconnectors for Photovoltaic**

	303
ON-OFF Switches for Panel Mounting	306
ON-OFF Switches for Single Hole Mounting	307
ON-OFF Switches for Base Mounting with Door Clutch	308
ON-OFF Switches for Distribution Boards	309
Main Switches for Panel Mounting	310
Main Switches for Single Hole Mounting	311
Main Switches for Base Mounting with Door Clutch	312
Main Switches for Distribution Boards	313
Main Switches in Plastic Enclosure	314

Technical data, dimension sketches, illustration and weights given in our list and printed matter, are subject to changed without notice.



**Push Buttons**

	327
Program B3	328
Push Buttons	330
EMERGENCY STOP Button	334
Key Operated Rotary Switches	334
Rotary Knobs and Swing Knobs	335
Illuminated Rotary Knobs and Swing Knobs	336
Illuminated Push Buttons	336
Double Push Buttons	336
Lens Caps	337
Monoblock-Multi-LED	337
Push Button-Sets	338
Illuminated Push Button-Sets	338
Pilot Lights	338
Connectors	340
Contact Blocks and Lamp Holders	340
Lamps, LED Lamps	341
Accessories	341
Label Holder, Legend Plates, Actuator Caps	342
Program B5	344
Push Buttons	345
Rotary Knobs and Swing Knobs	346
Key Operated Rotary Switches	347
Illuminated Push Button	347
Lens Caps	347
Connectors	348
Contact Blocks and Lamp Holders	348
Lamps, Accessories	349
Units for Surface Mounting	351
Assembled Units IP65	351
Enclosures BG.	352
Contact Blocks and Lamp Holders for Enclosures BG..	352
Push Buttons for Enclosures	353
Extensions for Push Buttons	355



**Representatives and Suppliers**

# Index

Page



## General

Approvals	4
Technical Information	5
Mounting Information	9
	10



## Micro Contactors

	11
Micro Contactors	12
Micro Contactor Relays	14
Micro Reversing Contactors	18
Technical Information	20
Dimensions	24



## Mini Contactors

	25
Mini Contactors	26
Interface Contactors	26
Mini Reversing Contactors	32
Technical Information	33
Dimensions	36



## Contactor Relays

	39
Contactor Relays	40
Technical Information	40
Dimensions	44



## Contactors

	45
Contactors Overview	46
Contactors, 3-pole	48
Contactors, 4-pole	50
Capacitor Switching Contactors	51
Accessories	52
Technical Information	62
Dimensions	82

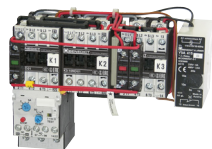

## Starters

	91
Star-Delta Starters	92
Reversing Contactors	96
Pole Changing Starters	98
Technical Information	100
Dimensions	107



## D.O.L. Starters

	111
D.O.L. Starters	112
Enclosures	113
Accessories	113
Technical Information	115
Dimensions	116



## Overload Relays

	119
Thermal Overload Relays	121
Accessories	123
Technical Information	125
Dimensions	129



## Modular Contactors

	133
Contactors	134
Accessories	135
Technical Information	138
Dimensions	140



## Contactors for DC-Switching Contactors RAST 5

	141
	145

Contactor, Motor-Starters

Circuit Breakers

Manual Motor-Starters

Switches

AC-Main Switches

DC-Switch Disconnectors

Push Buttons

Representatives, Suppliers

## General

### Test Authorities, Registration Mark, Approvals

Low voltage switchgear from Benedict GmbH is built and tested to national and international specifications. All devices suit all important specifications without any test obligation, like VDE, BS and also relative to IEC Recommendations and to European Standards like IEC 947 and EN 60947. It is for this reason of our Low voltage switchgear is used all over the world. In order to provide special versions, limitations to the max. voltages, currents and power ratings or special markings are sometimes necessary.

### Quality Control System

Since November 1991 Benedict GmbH has been certified according to the quality control system **ÖNORM EN ISO 29001**. The target of the ISO-certification is, to grant the customer the quality of the performance of his supplier, who is audited in accordance with this standard.

### CE-Marking



The manufacturer has to sign his products with the CE-Marking. With the CE-Marking the manufacturer confirms the accordance with the different EEC Directives. The CE-Marking is absolutely necessary to sell the products in the EEC.

Below you find the EEC Directives concerning our products.

Low Voltage Directive 2006/95/EC

EMC Directive 2004/108/EC

RoHS + WEEE 2002/95/EC + "002/96/EC

Country	North America	Russia	China
State deputy or private examination (state admitted)	UL Canada, USA	EAC	CCC
Label marking of examination boards	Listed Component		
Duty of approvals	all switchgear	all switchgear	all switchgear

### Explanations for choice and supply of low voltage switchgear in Canada and USA

#### Marking of auxiliary contacts

At several devices in UL-data are two voltages for auxiliary contacts mentioned (e. g.: 600 volts at same potential, 150 volts at different potentials). That means, if the voltage is higher than 150 volts, the control voltage applied to input terminals must be at the same potential.

Low voltage switchgear for auxiliary circuits (e. g. contactor relays, control units, auxiliary contacts in general) usually approved for "Heavy Duty" or "Standard Duty" UL and besides these marked with the admissible max. voltage or with short codes (see table).

Marking of auxiliary contacts according to CSA and UL	Max. rated values per pole			Cont. Current A	Contact Rating Code Designation
	Voltage V	Current Make A	Break A		
Heavy Duty (HD or HVY DTY)	AC 120	60	6	10	A150
	AC 240	30	3	10	A300
	AC 480	15	1,5	10	A600
	AC 600	12	1,2	10	A600
	DC 125	2,2	2,2	10	N150
	DC 250	1,1	1,1	10	N300
	DC 600	0,4	0,4	10	N600
Standard Duty (SD or STD DTY)	AC 120	30	3	5	B150
	AC 240	15	1,5	5	B300
	AC 480	7,5	0,75	5	B600
	AC 600	6	0,6	5	B600
	DC 125	1,1	1,1	5	P150
	DC 250	0,55	0,55	5	P300
	DC 600	0,2	0,2	5	P600
-	AC 120	15	1,5	2,5	C150
	AC 240	7,5	0,75	2,5	C300
	AC 480	3,75	0,375	2,5	C600
	AC 600	3	0,3	2,5	C600
	DC 125	0,55	0,55	2,5	Q150
	DC 250	0,27	0,27	2,5	Q300
	DC 600	0,1	0,1	2,5	Q600
-	AC 120	3,6	0,6	1	D150
	AC 240	1,8	0,3	1	D300
	DC 125	0,22	0,22	1	R150
	DC 250	0,11	0,11	1	R300
-	AC 120	1,8	0,3	0,5	E150

#### Discernment at UL-Standards

##### Recognized Component Industrial Control Equipment

UL issues yellow "Guide cards" with Guide- and File-No.

Devices have permission to be marked with on the label



##### Listed Industrial Control Equipment

UL issues white "Guide cards" with Guide- and File-No.

Devices have to be marked with the "UL-Listing Mark"



Devices as components approved for "factory wiring": devices for employment in control panels, when they are selected, mounted and wired according to the charging conditions by skilled worker.

Devices approved for "field wiring",







- a) devices for employment in control panels, when they are mounted and wired by skilled worker.
- b) devices for retail in USA

Valid UL-Standards:  
UL 508 "Standard for Industrial Control Equipment" (partly limited)

Valid UL-Standards:  
UL 508 "Standard for Industrial Control Equipment" (unlimited)

Are devices approved as "Listed Equipment" the approval is also valid for using as "Recognized Component" .







# Approvals

Country	North America		Switzerland	Europe	Russia EAC	China	CENELEC CB-Certificates
Type	UL 		SEV 				
<b>Micro Contactor Relays, Micro Contactors K0, Micro Reversing Contactors and Accessories</b>							
K0-04D..	o	-	-	o	-	-	-
K0-05D..	o	-	-	o	-	o	-
K0W05D..	o	-	-	o	-	o	-
<b>Mini Contactor Relays, Mini Contactors, Mini Reversing Contactors K1 and Accessories</b>							
K1-07D..(=)	o	-	-	o	o	-	o
K1-07L..(=)	-	o	-	o	o	-	o
K1-07F..(=)	-	o	-	o	o	-	-
K1-09D..(=)	o	-	-	o	o	o	o
K1-09L..(=)	-	o	-	o	o	o	o
K1-09F..(=)	-	o	-	o	o	o	-
K1-12D..(=)	o	-	-	o	o	o	-
K1W09D01(=)	o	-	-	o	o	o	-
K1W12D01(=)	o	-	-	o	o	o	-
K1W09L01(=)	-	o	-	o	o	o	-
HK..., HKM..	o	-	-	o	o	-	o
RC-K1	o	-	-	o	o	-	-
<b>Contactor Relays, Contactors Series K3</b>							
K3-07ND..(=)	o	-	-	o	o	-	-
K3-10N..(=)	o	-	o	o	o	o	o
K3-14N..(=)	o	-	o	o	o	o	o
K3-18N..(=)	o	-	o	o	o	o	o
K3-22N..(=)	o	-	o	o	o	o	o
K3-24A..(=)	o	-	o	o	o	o	o
K3-32A..(=)	o	-	o	o	o	o	o
K3-40A..(=)	o	-	o	o	o	o	o
K3-50A..(=)	o	-	o	o	o	o	o
K3-62A..(=)	o	-	o	o	o	o	o
K3-74A..(=)	o	-	o	o	o	o	o
K3-90A..(=)	o	-	-	o	o	o	-
K3-115A..(=)	o	-	-	o	o	o	-
K3-151A..(=)	o	-	-	o	o	-	-
K3-176A..(=)	o	-	-	o	o	-	-
K3-210A..(=)	x	-	-	o	o	-	-
K3-260A..(=)	x	-	-	o	o	-	-
K3-316A..(=)	x	-	-	o	o	-	-
K3-450A..(=)	o	-	-	o	o	-	-
K3-550A..(=)	o	-	-	o	o	-	-
K3-700A..(=)	o	-	-	o	o	-	-
K3-860A..(=)	o	-	-	o	o	-	-
K3-1000A..(=)	-	-	-	o	o	-	-
K3-1200A..(=)	o	-	-	o	o	-	-
<b>Contactor Relays, Contactors DC operated Series KG3</b>							
KG3-07..	o	-	-	o	o	-	o
KG3-10..., -14..	o	-	-	o	o	-	o
KG3-18..., -22..	o	-	-	o	o	-	o
KG3-24..., -32..	o	-	-	o	o	-	o
KG3-40..	o	-	-	o	o	-	o
<b>Capacitor Contactors Series K3</b>							
K3-18K..	o	-	-	o	o	o	o
K3-24K..	o	-	-	o	o	o	o
K3-32K..	o	-	-	o	o	o	o
K3-50K..	o	-	-	o	o	o	o
K3-62K..	o	-	-	o	o	o	o
K3-74K..	o	-	-	o	o	o	o
K3-90K..	o	-	-	o	o	o	-
K3-115K..	o	-	-	o	o	o	-
<b>Aux. Contacts</b>							
HN..., HTN..	o	-	-	o	o	o	o
HA..	o	-	-	o	o	-	o
HB..	o	-	-	o	o	o	o
K2-DK, K2-SK	o	-	-	o	o	-	-
HKA..., HKT..	o	-	-	o	o	-	-
HKF22	-	-	-	o	o	-	-

o approved in standard version      x pending      - not provided to be tested

Contactors, Motor-Starter  
 Circuit Breakers  
 Manual Motor-Starters  
 Switches  
 AC-Main Switches  
 DC-Switch Disconnect  
 Push Buttons  
 Representatives, Suppliers

# Approvals

Country	North America		Switzerland	Europe	Russia EAC	China	CENELEC CB-Certificates
Typ	UL		SEV				
							
<b>Accessories</b>							
K2-T.E, -A	-	-	-	0	0	-	-
K2-TP	0	-	-	0	0	-	-
K2-L	0	-	-	0	0	-	-
K2-IN.	0	-	-	0	0	-	-
K2-UN.	0	-	-	0	0	-	-
K2-IM	-	-	-	0	0	-	-
K2-E	0	-	-	0	0	-	-
VG-K2	-	-	-	0	0	-	-
RC-K3	0	-	-	0	0	-	-
<b>Reversing Contactors Series K3NWU</b>							
K3NWU-10	0	-	-	0	0	-	-
K3NWU-14	0	-	-	0	0	-	-
K3NWU-18	0	-	-	0	0	-	-
K3NWU-22	0	-	-	0	0	-	-
K3WU-24	0	-	-	0	0	-	-
K3WU-32	0	-	-	0	0	-	-
K3WU-40	0	-	-	0	0	-	-
<b>D.O.L Starters</b>							
P1..	0	-	-	0	0	-	-
<b>Thermal Overload Relays</b>							
U3/32	0	-	-	0	0	-	0
U3/42	0	-	-	0	0	-	0
U3/74	0	-	-	0	0	-	0
U12/16E	0	-	-	0	0	-	0
U12/16A	-	-	-	0	0	-	0
U12/16EM	-	-	-	0	0	-	0
U12/16EQ	-	-	-	0	0	-	0
U32	0	-	-	0	0	-	0
U60	0	-	-	0	0	-	0
U85	0	-	-	0	0	-	0
U180	x	-	-	0	0	-	-
U320	x	-	-	0	0	-	-
U800	-	-	-	0	0	-	-
<b>Modular Contactors</b>							
R20	0	-	0	0	0	-	0
R25	0	-	0	0	0	-	0
R40	0	-	0	0	0	-	0
R63	0	-	0	0	0	-	0
R40, R63 2-polig	-	-	-	0	0	-	0
RH11	0	-	-	0	0	-	0
<b>Push Buttons</b>							
B(C,K,S)3/4/5D	0	-	-	0	0	-	0
<b>Contactors Relays and Contactors Series K3 (RAST 5)</b>							
K3-10/14/18/22NR	0	-	-	0	0	0	0
<b>Contactors for DC-Loads</b>							
K3DC-20 bis 80	0	-	-	0	0	-	0
K3DC-100	-	-	-	0	0	-	0
K3PV-30 bis 60	-	-	-	0	0	-	0
K3PV-80	0	-	-	0	0	-	0
K3PV-100	-	-	-	0	0	-	0
K3PV-150 bis 450	0	-	-	0	0	-	0
<b>Main Contactors Series K3</b>							
K3-10/14/18/22NBD	-	-	-	0	0	-	0

o approved in standard version

x pending

- not provided to be tested

# Approvals

Country	North America		Switzerland	Europe	Russia EAC	China	CENELEC CB-Certificates
Typ	UL		SEV	CE	EAC	CCC	
							

## Motor Protection Circuit Breakers Series M4-..

M4-32T	o	-	-	o	o	-	-
M4-32R	o	-	-	o	o	-	-
M4-63R	o	-	-	o	o	-	-
M4-100R	o	-	-	o	o	-	-

## Zubehör

M4 HQ	o	-	-	o	o	-	-
M4 HS	o	-	-	o	o	-	-
M4 MA	o	-	-	o	o	-	-
M4 M	o	-	-	o	o	-	-
M4 U	o	-	-	o	o	-	-
M4 A	o	-	-	o	o	-	-

## Motor Protection Circuit Breakers Series MU25A-..

MU25A	o	-	-	o	-	-	-
-------	---	---	---	---	---	---	---

## Accessories

MU25A-PS	o	-	-	o	-	-	-
MU25A-PV	o	-	-	o	-	-	-
MU25A-A	o	-	-	o	-	-	-
MU25A-U	o	-	-	o	-	-	-

## Mini DC-Isolators

LSM(O)16/25/32/38	o	-	-	-	o	-	-
-------------------	---	---	---	---	---	---	---

## DC-Switch Disconnectors, 2, 2+2, 4 pole

LS16/20/25/32	o	-	-	o	o	o	o
LS40/55/65	o	-	-	o	o	o	o

## DC-Switch Disconnectors, 3+2, 4+2, 6, 8 pole

LS16/20/25/32	o	-	-	o	o	o	-
LS40/55/65	o	-	-	o	o	o	-

## AC-Main Switches

LTS20/25/32/40	o	-	-	o	o	-	o
LTS63/80	o	-	-	o	o	-	o
LTS85/100/125	o	-	-	o	o	-	o

## AC-Cam Switches

M4H	o	-	-	o	o	-	o
M10	o	-	-	o	o	-	o
M10H(D)	o	-	-	o	o	-	o
M20	o	-	-	o	o	-	o
N33F	o	-	-	o	o	-	o
N40	o	-	-	o	o	-	o
N60	o	-	-	o	o	-	o
N61	o	-	-	o	o	-	o
N80	o	-	-	o	o	-	o
N100	o	-	-	o	o	-	o
N200	o	-	-	o	o	-	o
L400	o	-	-	o	o	-	o

o approved in standard version

x pending

- not provided to be tested

**cUL<sup>us</sup> - and cRU<sup>us</sup> - Guide- and File-No.**

These data are important for UL-inspectors.  
Devices

Devices	Guide-No.				File-No.
	cUL <sup>us</sup>		cRU <sup>us</sup>		
	Canada	USA	Canada	USA	
Contactors	NLDX7	NLDX	NLDX8	NLDX2	E41502
Reversing Contactors	NLDX7	NLDX	-	-	E41502
Contactors Relays, Accessories	NKCR7	NKCR	NKCR8	NKCR2	E66273
Thermal Overload Relays	NKCR7	NKCR	-	-	E66273
Cam Switches	NLRV7	NLRV	-	-	E129916
Circuit Breakers as Manual Motor Controller	NLRV7	NLRV	-	-	E129916
Circuit Breakers as Combination Motor Controller	NKJH7	NKJH	-	-	E197641
Bus Bar Assemblies	NLRV7	NLRV	-	-	E129916
Accessories for Circuit Breakers	NKCR7	NKCR	-	-	E66273
DC disconnectors as Industrial Control switches	NRNT7	NRNT	NRNT8	NRNT2	E332938
DC disconnectors as Photovoltaic Manual-disconnect switches	-	NMSJ	-	NMSJ2	E2359344

## Technical Information

### Degree of protection acc. to IEC 60947-1

Protection ratings are prefixed by the internationally agreed letters IP followed by two digits.

1<sup>st</sup> digit: Pertains to solid objects  
2<sup>nd</sup> digit: Pertains to water.

1 <sup>st</sup> digit	Short description	Definition
1	Protected against solid objects greater than 50 mm	Excludes solid objects exceeding 50 mm in diameter and protects against contact with live and moving parts by a large body surface such as a hand (but not against deliberate access).
2L	Protected against solid objects greater than 12,5 mm and against contact by standard test finger	Excludes solid objects exceeding 12,5 mm in diameter and protects against contact with live and moving parts by a standard test finger or similar objects not exceeding 80 mm in length.
3	Protected against solid objects	Excludes solid objects exceeding 2,5 mm in diameter or thickness, greater than 2,5mm
4	Protected against solid objects greater than 1 mm	Excludes solid objects exceeding 1 mm in diameter or thickness.
5	Dust protected	Prevents ingress of dust in quantities and locations that would interfere with the intended operation of the equipment.
6	Dust tight	Prevents ingress of dust.

### Terminal markings acc. to EN50011

Auxiliary contacts of AC contactors and contacts of contactor relays and thermal overload relays are particularly marked. The terminal markings of normally-open contacts are printed as positive figures, they of normally-closed contacts as negative figures.

This gives a clear indication of the function of the contacts.

The figure below illustrates the determination of terminal markings for contactors with auxiliary contact blocks.

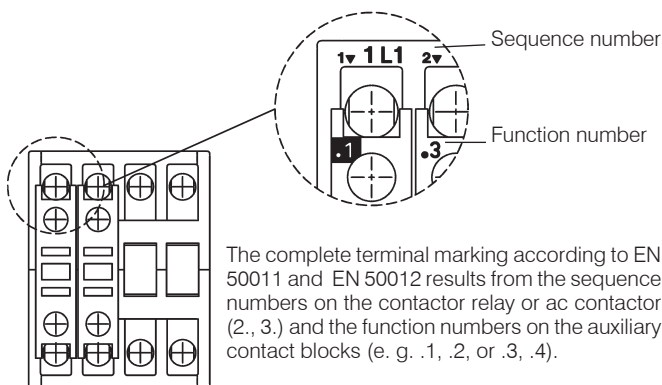

2 <sup>nd</sup> digit	Short description	Definition
1	Protected against dripping water	Dripping water (vertically falling drops) shall have no harmful effect.
2	Protected against dripping water when tilted up to 15°	Vertically dripping water shall have no harmful effect when the enclosure is tilted at any angle up to 15° from its normal position.
3	Protected against spraying water	Water falling as a spray at an angle up to 60° from the vertical shall have no harmful effect.
4	Protected against splashing water	Water splashed against the enclosure from any direction shall have no harmful effect.
5	Protected against water jets	Water protected by a nozzle against the enclosure from any direction shall have no harmful effect.
6	Protected against heavy seas	Water from heavy seas or water projected in powerful jets shall not enter the enclosure in harmful quantities.
7	Protected against the effects of immersion	Ingress of water in a harmful quantity shall not be possible when the enclosure is immersed in water under standard conditions of pressure and time.
8	Protected against submersion	No ingress of water.

### Resistance to climatic conditions acc. to IEC60068

Open-type devices are climate-resistant in the constant climate according to IEC60068-2-78 (this is a climate with an ambient temperature of 40°C and an atmospheric humidity of 90 to 95%).

Enclosed devices are climate-resistant in an alternating climate according to IEC 68-2-30 (this is a moist alternating climate with a 24-hour cycle between climates with an ambient temperature of 25°C, and an atmospheric humidity of 95 to 100% and an ambient temperature of 40°C, and an atmospheric humidity of 90 to 96% in the presence of condensation during rises in temperature).

Data are valid up to an altitude of 2000m above sea level.

### Short circuit protection

Back up fuses should be used to protect contactors and starters against short circuits. For starters the device with the smaller admissible fuse at the main and at the control circuit (contactor or thermal overload) determines the fuse size.

After a short circuit devices have to be checked for correct operation. Disconnect power before proceeding with any work on the equipment!

# Technical Information

## Mounting positions of contactors

K0-.. / K1-..

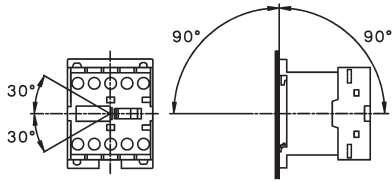

K(G)3-07.. to K3-115.., R20-.. to R63-..

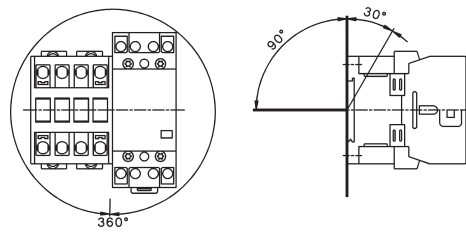



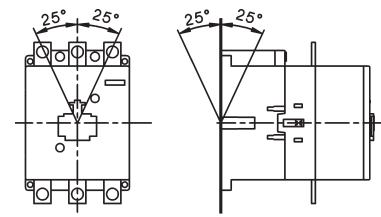



K3-151.. to K3-1200..  
K3DC-20.. to K3DC-100..  
K3PV-12.. to K3PV-450..



## Terminal screws

Devices Type	Kind of connection			Screw driver	Tightening torque	
	Screw with washer	Screw with clamp box	Screw w. nut		Nm	lb. inch
<b>Micro Contactors</b> , all conductors K0-..	M2,5	-	-	Pz1	0,6 - 0,8	5 - 7
<b>Mini Contactors</b> , all conductors K1-..	M3,5	-	-	Pz2	0,8 - 1,4	7 - 12
<b>Contactors Relays</b> , all conductors K(G)3-07..	M3,5	-	-	Pz2	0,8 - 1,4	7 - 12
<b>Contactors</b> Main conductor						
K(G)3-10.. bis K3-22..	M3,5	-	-	Pz2	0,8 - 1,4	7 - 12
K(G)3-24.. bis K3-40..	-	M5	-	Pz2	2,5 - 3	22 - 26
K3-50.. bis K3-74..	-	M6	-	Pz3	3,5 - 4,5	31 - 40
K2-23, -30, -37A00-40 K2-45, -60A00-40	M4 -	- M6	- -	Pz2 Pz3	1,2 - 1,8 3,5 - 4,5	11 - 16 31 - 40
K3-90, K3-115	-	-	M8	4mm hex socket	4 - 6,5	35 - 57
K3-116.. bis K3-176.. K3-210.. bis K3-316.. K3-450.. bis K3-700.. K3-860.. K3-1000.., K3-1200..	- - - - -	- - - - -	M8 M10 M12 M14 M12		17 35 60 75 60	150 315 540 675 540
Auxiliary conductor K(G)3-10 bis K3-22	M3,5	-	-	Pz2	0,8 - 1,4	7 - 12
Coil conductor K(G)3-10 bis K3-1200	M3,5	-	-	Pz2	0,8 - 1,4	7 - 12
<b>Accessories</b> HK, HKM HA, HN, K2-..., HB..	M3,5 M3,5	- -	- -	Pz2 Pz2	0,8 - 1,4 0,8 - 1,4	7 - 12 7 - 12
<b>Thermal Overload Relays</b> Main conductor						
U12/16	M4	-	-	Pz2	1,2 - 1,8	11 - 16
U3/32 U3/42 U3/74	M3,5 M5 -	- - M6	- - -	Pz2 Pz2 Pz3	0,8 - 1,4 2,5 - 3 3,5 - 4,5	7 - 12 22 - 26 31 - 40
UAT21 UAT22 UAT23	- - -	M4 M4 M5	- - -	Size 3, 4 Size 3, 4 Size 3, 4, 5	1,2 - 1,8 1,2 - 1,8 2,5 - 3	11 - 16 11 - 16 22 - 26
Auxiliary conductor All devices	M3,5	-	-	Pz2	0,8 - 1,4	7 - 12
<b>Contactors for Distribution Boards</b> Conductors						
R20, R25 R40, R63 K1R	- - M3,5	M3,5 M5 -	- - -	Pz1 Pz2 Pz2	0,8 - 1,4 2,5 - 3 0,8 - 1,4	7 - 12 22 - 26 7 - 12
Coil conductor R20, R25 R40, R63 (2pole / 4 pole) K1R RH11	- - M3,5 -	M3 M3 - M3	- - - -	Pz1 Pz1 Pz2 Pz1	0,6 - 1,2 0,6 - 1,2 0,8 - 1,4 0,6 - 1,2	5 - 11 5 - 11 7 - 12 5 - 11

	<p>Micro Contactor Relays</p>	<p>12</p>
	<p>Micro Contactors</p>	<p>14</p>
	<p>Micro Contactors With Solder Pins</p> <p>Coil voltages</p>	<p>16</p> <p>16</p>
	<p>Micro Reversing Contactor</p>	<p>18</p>
	<p>Technical Data</p>	<p>20</p>
	<p>Dimensions</p>	<p>24</p>

# Micro Contactor Relays 4-pole

AC Operated

Ratings Therm.	Contacts <sup>2)</sup>		Type	Coil voltage <sup>1)</sup>
	Distinc. Number	Additional Contact		
	<b>24</b>			24V 50/60Hz
	<b>230</b>			220-240V 50Hz/60Hz

**AC15**

Rated Current $I_{th}$ A	400V A	NO	NC	acc. to EN50011	Blocks Type	↓	Pack pcs.	Weight kg/pc.
--------------------------	--------	----	----	-----------------	-------------	---	-----------	---------------

**4-pole, with Screw Terminals**



<b>3</b>	1,5	5	4	-	40E	-	<b>K0-04D40 ...</b>	10	0,07
<b>3</b>	1,5	5	3	1	31E	-	<b>K0-04D31 ...</b>	10	0,07
<b>3</b>	1,5	5	2	2	22E	-	<b>K0-04D22 ...</b>	10	0,07

**K0-04D40**

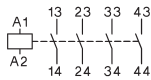

**K0-04D31**

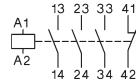

**K0-04D22**

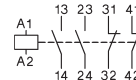

1) Other coil voltages see page 16.

2) Contacts suitable for electronic circuits, according to EN947-5-4 for rated voltage 24V DC (test ratings 17V DC, 5mA). Mirror contacts acc. IEC60947-4-1 Annex F.

# Micro Contactor Relays 4-pole

DC Operated

Ratings Therm.	Contacts <sup>2)</sup>	Distinc. Number	Additional Contact	Type	Coil voltage <sup>1)</sup>	Pack pcs.	Weight kg/pc.
<b>AC15</b>							
<b>230V A</b>	400V A						



## 4-pole, with Screw Terminals

<b>3</b>	1,5	5	4	-	40E	-	<b>K0-04D40= ...</b>	10	0,09
<b>3</b>	1,5	5	3	1	31E	-	<b>K0-04D31= ...</b>	10	0,09
<b>3</b>	1,5	5	2	2	22E	-	<b>K0-04D22= ...</b>	10	0,09

**K0-04D40**

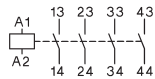

**K0-04D31**

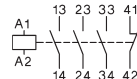

**K0-04D22**

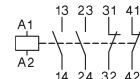

1) Other coil voltages on request.  
 2) Contacts suitable for electronic circuits, according to EN947-5-4 for rated voltage 24V DC (test ratings 17V DC, 5mA). Mirror contacts acc. IEC60947-4-1 Annex F.  
 3) with integrated coil suppressor (Transient Voltage Suppressor Diode)

# Micro Contactors

AC Operated



Power Ratings	Rated Current	Aux. Contacts <sup>2)</sup>		Type	Coil voltage <sup>1)</sup>	Pack pcs.	Weight kg/pc.
		Built-in	Additional				
AC2, AC3 <b>380V</b> <b>400V</b> <b>415V</b> <b>kW</b>	660V 690V A	AC1	NO NC	<b>24</b> <b>230</b>	24V 50/60Hz 220-240V 50Hz/60Hz		
			Blocks Type	↓			

## 3-pole, with Screw Terminals

2,2	-	12	1	-	-	<b>KO-05D10 ...</b>	10	0,07
-----	---	----	---	---	---	---------------------	----	------

2,2	-	12	-	1	-	<b>KO-05D01 ...</b>	10	0,07
-----	---	----	---	---	---	---------------------	----	------

## 4-pole, With Screw Terminals

2,2	-	12	-	-	-	<b>KO-05D00-40 ...</b>	10	0,07
-----	---	----	---	---	---	------------------------	----	------

**KO-05D10**

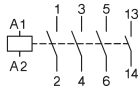

**KO-05D01**

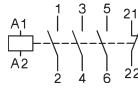

**KO-05D00-40**

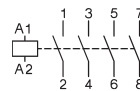

1) Other coil voltages see page 16.

2) Contacts suitable for electronic circuits, according to EN947-5-4 for rated voltage 24V DC (test ratings 17V DC, 5mA). Mirror contacts acc. IEC60947-4-1 Annex F.

# Micro Contactors

DC Operated

Power Ratings	Rated Current	Aux. Contacts <sup>2)</sup>		Type	Coil voltage <sup>1)</sup>	Pack pcs.	Weight kg/pc.
		Built-in	Additional				
AC2, AC3	AC1			= 24 = 24VS	24V= DC 24V= DC with protection <sup>3)</sup>		
<b>380V</b>				↓			
<b>400V</b>	660V						
<b>415V</b>	690V	440V					
<b>kW</b>	<b>kW</b>	<b>A</b>	NO NC		Blocks Type		



## 3-pole, with Screw Terminals

2,2	-	12	1	-	-	<b>K0-05D10= ...</b>	10	0,09
-----	---	----	---	---	---	----------------------	----	------

2,2	-	12	-	1	-	<b>K0-05D01= ...</b>	10	0,09
-----	---	----	---	---	---	----------------------	----	------

## 4-pole, With Screw Terminals

2,2	-	12	-	-	-	<b>K0-05D00-40= ...</b>	10	0,09
-----	---	----	---	---	---	-------------------------	----	------

**K0-05D10**

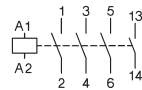

**K0-05D01**

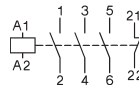

**K0-05D00-40**

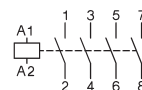

# Snap-On Adapter

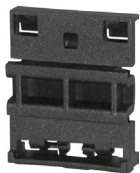

For Type	Specification	Type	Pack pcs..	Weight kg/pc.
K0	Snap on Adapter for K0	P1039	10	0,0061
	for snap-on mounting of contactor K0 on 35mm DIN-rail acc. DIN EN 50022			

1) Other coil voltages on request.  
 2) Contacts suitable for electronic circuits, according to EN947-5-4 for rated voltage 24V DC (test ratings 17V DC, 5mA). Mirror contacts acc. IEC60947-4-1 Annex F.  
 3) with integrated coil suppressor (Transient Voltage Suppressor Diode)

# Micro Contactors

## AC Operated

Power Ratings	Rated Current	Aux. Contacts <sup>2)</sup>		Type	Coil voltage <sup>1)</sup>	Pack pcs.	Weight kg/pc.
		Built in	Additional				
AC2, AC3	AC1				24V 50/60Hz		
<b>380V</b>					220-240V 50Hz/60Hz		
<b>400V</b>	660V						
<b>415V</b>	690V	440V					
<b>kW</b>	<b>kW</b>	<b>A</b>					



### 3-pole, with Solder Pins Ø1,15 for Printed Circuit Applications

2,2	-	9	1	-	-	<b>K0-05L10</b> ...	10	0,07
-----	---	---	---	---	---	---------------------	----	------

2,2	-	9	-	1	-	<b>K0-05L01</b> ...	10	0,07
-----	---	---	---	---	---	---------------------	----	------

### 4-pole, with Solder Pins Ø1,15 for Printed Circuit Applications

2,2	-	9	-	-	-	<b>K0-05L00-40</b> ...	10	0,07
-----	---	---	---	---	---	------------------------	----	------

**K0-05L10**

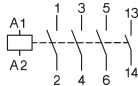

**K0-05L01**

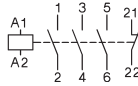

**K0-05L00-40**

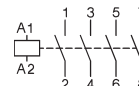

## Coil voltages for AC operated contactors

Suffix to contactor type e.g. K0-05D10 24	Voltage Marking at the coil for		Rated Control Voltage U <sub>s</sub> range for 50Hz				for 60Hz	
	50Hz	60Hz	min.	max.	min.	max.	min.	max.
12	12	12	11	12	12	12		
<b>24</b>	<b>24</b>	<b>24</b>	<b>22</b>	<b>24</b>	<b>24</b>	<b>24</b>		
42	42	42	38,5	42	42	42		
48	48	48	48	50	48	52		
90	100	100	90	100	100	105		
95	95-100	105-110	95	100	105	110		
100	100	110-115	100	105	110	115		
105	105-110	115-120	105	110	115	120		
110	110-115	120-125	110	115	120	125		
180	200	200	185	200	200	210		

Suffix to contactor type e.g. K0-05D10 230	Voltage Marking at the coil for		Rated Control Voltage U <sub>s</sub> range for 50Hz				for 60Hz	
	50Hz	60Hz	min.	max.	min.	max.	min.	max.
200	200	200-220	195	205	200	220		
210	205-215	220-230	205	215	220	230		
220	210-220	220-240	210	220	220	240		
<b>230</b>	<b>220-230</b>	<b>230-250</b>	<b>220</b>	<b>230</b>	<b>230</b>	<b>250</b>		
240	230-240		230	240	250	260		

**Standard voltages in bold type letters**  
**Operating range of magnet-coils: 0,85 x U<sub>s</sub>**  
**(min. value of rated control voltage)**  
**up to 1,1 x U<sub>s</sub>**  
**(max. value of rated control voltage)**

Coil not exchangeable

1) Other coil voltages see above table.

2) Contacts suitable for electronic circuits, according to EN947-5-4 for rated voltage 24V DC (test ratings 17V DC, 5mA). Mirror contacts acc. IEC60947-4-1 Annex F.

# Micro Contactors

DC Operated

Power Ratings	Rated Current	Aux. Contacts <sup>2)</sup>		Type	Coil voltage <sup>1)</sup> = 24 24V= DC = 24VS 24V= DC with protection <sup>3)</sup>	Pack pcs.	Weight kg/pc.
		Built in	Additional				
AC2, AC3 <b>380V</b> <b>400V</b> <b>415V</b> <b>kW</b>	660V 690V A	AC1					
			NO NC	Type			



### 3-pole, with Solder Pins Ø1,15 for Printed Circuit Applications

2,2	-	9	1	-	-	<b>K0-05L10 ...</b>	10	0,07
2,2	-	9	-	1	-	<b>K0-05L01 ...</b>	10	0,07

### 4-pole, with Solder Pins Ø1,15 for Printed Circuit Applications

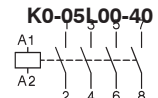
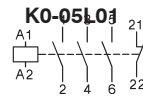
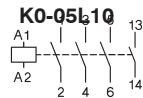

2,2	-	9	-	-	-	<b>K0-05L00-40 ...</b>	10	0,07
-----	---	---	---	---	---	------------------------	----	------



1) Other coil voltages on request.  
 2) Contacts suitable for electronic circuits, according to EN947-5-4 for rated voltage 24V DC (test ratings 17V DC, 5mA). Mirror contacts acc. IEC60947-4-1 Annex F.  
 3) with integrated coil suppressor (Transient Voltage Suppressor Diode)

# Micro Reversing Contactors, Mechanical Interlocked

AC Operated

Power Ratings	Rated Current	Aux. Contacts <sup>2)</sup>		Type		Coil voltage <sup>1)</sup> 24V 50/60Hz 220-240V 50Hz/60Hz	Pack pcs.	Weight kg/pc.
		Built-in	Additional on left hand side Contactor	on right hand side Contactor	24 230			
AC2, AC3 <b>380V</b> <b>400V</b> <b>415V</b> <b>kW</b>	AC1 660V 690V kW	440V A	 	K1 Type	K2 Type			

## 3-pole, with Screw Terminals



2,2	-	12	-	2	-	-	<b>K0W05D01MS ...</b>	1	0,14
-----	---	----	---	---	---	---	-----------------------	---	------

2,2	-	12	2	-	-	-	<b>K0W05D10MS ...</b>	1	0,14
-----	---	----	---	---	---	---	-----------------------	---	------

## 4-pole, with Screw Terminals



2,2	-	12	-	-	-	-	<b>K0W05D00-40MS ...</b>	1	0,14
-----	---	----	---	---	---	---	--------------------------	---	------

## 3-pole, with Solder Pins Ø1,15 for Printed Circuit Applications

2,2	-	xxx <sup>3)</sup>	-	2	-	-	<b>K0W05L01MS ...</b>	1	0,14
-----	---	-------------------	---	---	---	---	-----------------------	---	------

2,2	-	xxx <sup>3)</sup>	2	-	-	-	<b>K0W05L10MS ...</b>	1	0,14
-----	---	-------------------	---	---	---	---	-----------------------	---	------

**K0W05D01MS**

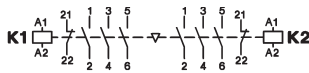

**K0W05D10MS**

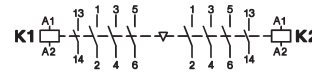

**K0W05D00-40MS**

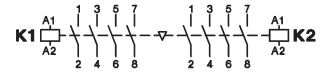

# Reversing Starter Connector



For Reversing Starter Types, incl. Coil Connector

Type	Pack pcs.	Weight kg/pc.
<b>K0W05D..MS</b>	<b>K0W-VB</b>	1 0,01

1) Other coil voltages see page 16.  
 2) Contacts suitable for electronic circuits, according to EN947-5-4 for rated voltage 24V DC (test ratings 17V DC, 5mA). Mirror contacts acc. IEC60947-4-1 Annex F.  
 3) Data on request.

# Micro Reversing Contactors, Mechanical Interlocked

DC Operated

Power Ratings	Rated Current	Aux. Contacts <sup>2)</sup>		Type		Coil voltage <sup>1)</sup> = 24 24V= DC = 24VS 24V= DC with protection <sup>3)</sup>	Pack pcs.	Weight kg/pc.
		Built-in	Additional on left	on right	hand side Contactor			
AC2, AC3	AC1							
<b>380V</b>								
<b>400V</b>	660V							
<b>415V</b>	690V	440V						
<b>kW</b>	<b>kW</b>	<b>A</b>	NO NC	K1 Type	K2 Type			



### 3-pole, with Screw Terminals

2,2	-	12	-	2	-	-	<b>K0W05D01MS ...</b>	1	0,14
2,2	-	12	2	-	-	-	<b>K0W05D10MS ...</b>	1	0,14

### 4-pole, with Screw Terminals

2,2	-	12	-	-	-	-	<b>K0W05D00-40MS ...</b>	1	0,14
-----	---	----	---	---	---	---	--------------------------	---	------



### 3-pole, with Solder Pins Ø1,15 for Printed Circuit Applications

2,2	-	xxx <sup>4)</sup>	-	2	-	-	<b>K0W05L01MS ...</b>	1	0,14
2,2	-	xxx <sup>4)</sup>	2	-	-	-	<b>K0W05L10MS ...</b>	1	0,14

**K0W05D01MS**

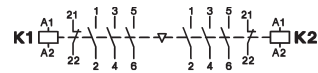

**K0W05D10MS**

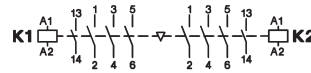

**K0W05D00-40MS**

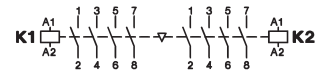

- 1) Other coil voltages on request.
- 2) Contacts suitable for electronic circuits, according to EN947-5-4 for rated voltage 24V DC (test ratings 17V DC, 5mA). Mirror contacts acc. IEC60947-4-1 Annex F.
- 3) with integrated coil suppressor (Transient Voltage Suppressor Diode)
- 4) Data on request.

Contactors, Motor-Starters  
 Circuit Breakers  
 Manual Motor-Starters  
 Switches  
 AC-Main Switches  
 DC-Switch Disconnectors  
 Push Buttons  
 Representatives, Suppliers

# Micro Contactors

## Data according to IEC 60947-4-1, VDE 0660, EN 60947-4-1

Main Contacts	Type	K0-05D..	K0-05L..
<b>Rated insulation voltage <math>U_i</math></b>	V AC	440 <sup>1)</sup>	440 <sup>1)</sup>
<b>Making capacity <math>I_{eff}</math></b> at $U_e = 440V$ AC	A	65	65
<b>Breaking capacity <math>I_{eff}</math></b> $\cos\phi = 0,65$	400V AC A	50	50
<b>Utilization category AC1</b>			
<b>Switching of resistive load</b>			
Rated operational current $I_e (=I_{th})$ at 40°C, open	<b>A</b>	<b>12</b>	<b>9</b>
Rated operational power of three-phase resistive loads 50-60Hz, $\cos\phi = 1$	230V kW	4,7	3,5
	240V kW	4,8	3,7
	400V kW	8,3	3,3
	415V kW	8,6	6,4
	440V kW	9,0	6,8
Rated operational current $I_e (=I_{th})$ at 60°C, enclosed	A	8	6
Rated operational power of three-phase resistive loads 50-60Hz, $\cos\phi = 1$	230V kW	3,1	2,3
	240V kW	3,3	2,4
	400V kW	5,5	4,1
	415V kW	5,7	4,3
	440V kW	6,0	4,5
Minimum cross-section of conductor at load with $I_e (=I_{th})$	mm <sup>2</sup>	1,5	-
<b>Utilization category AC2 and AC3</b>			
<b>Switching of three-phase motors</b>			
Rated operational current $I_e$ open and enclosed	220V A	6,2	6,2
	230V A	6,2	6,2
	240V A	5,6	5,6
<b>380-400V</b>	<b>A</b>	<b>5</b>	<b>5</b>
	415-440V A	5	5
Rated operational power of three-phase motors 50-60Hz	220-240V kW	1,5	1,5
	<b>380-440V kW</b>	<b>2,2</b>	<b>2,2</b>
<b>Utilization category AC4</b>			
<b>Switching of squirrel cage motors, inching</b>			
Rated operational current $I_e$ open and enclosed	220V A	4,9	4,9
	230V A	4,9	4,9
	240V A	4,1	4,1
<b>380-400V</b>	<b>A</b>	<b>3,5</b>	<b>3,5</b>
	415-440V A	3,5	3,5
Rated operational power of three-phase motors 50-60Hz	220-240V kW	1,1	1,1
	<b>380-440V kW</b>	<b>1,5</b>	<b>1,5</b>
<b>Utilization category AC5a</b>			
<b>Switching of gas discharge lamps</b>			
Rated operational current $I_e$ per pole at 220/230V			
Fluorescent lamps, uncompensated and serial compensated parallel compensated dual-connection	A	6	6
	A	0,5	0,5
	A	9	9
Metal halide lamps <sup>2)</sup> , uncompensated parallel compensated	A	6	6
	A	0,5	0,5
Mercury-vapour lamps <sup>3)</sup> , uncompensated parallel compensated	A	9	9
	A	0,5	0,5
Mixed light lamps <sup>4)</sup>	A	9	9
<b>LED-Lamps</b>			
consider the inrush current of the lamp ballast and $\cos\phi$ of the lamp	max. lamps per pole ( $I_{nLED} \leq I_{th}$ ) =	$\frac{\text{inrush current of contactor}}{\text{inrush current of lamp/EVG}}$	
max inrush current of contactor	A	91	91
<b>Utilization category AC5b</b>			
<b>Switching of incandescent lamps<sup>5)</sup></b>			
Rated operational current $I_e$ per pole at 220/230V	A	3	3

1) Suitable for: earthed-neutral systems, overvoltage category I to III, pollution degree 3 (standard-industry):  $U_{imp} = 4kV$ .  
Data for other conditions on request.

2) Metal halide lamps and sodium-vapour lamps (high- and low-pressure lamps)

3) High-pressure lamps

4) Blended lamps, containing a mercury high-pressure unit and a tungsten helix in a fluorescent glass bulb (daylight lamps)

5) Current inrush approx. 16 x  $I_e$

# Micro Contactors

## Data according to IEC 60947-4-1, VDE 0660, EN 60947-4-1

Main Contacts			Type	K0-05D..	K0-05L..
<b>Utilization category DC1</b>					
<b>Switching of resistive load</b>	1 pole	24V - 60V	A	12	9
Time constant L/R ≤1ms		110V	A	2	2
Rated operational current I <sub>e</sub>		180V	A	0,6	0,6
		220V	A	0,4	0,4
	2 poles in series	24V - 110V	A	12	9
		180V - 220V	A	2	2
	3 poles in series	24V - 180V	A	12	9
		220V	A	8	8
<b>Utilization category DC3 and DC5</b>					
<b>Switching of shunt motors and series motors</b>	1 pole	24V	A	12	9
Time constant L/R ≤15ms		60V	A	4	4
Rated operational current I <sub>e</sub>		110V	A	1	1
		180V	A	0,5	0,5
		220V	A	0,3	0,3
	2 poles in series	24V - 60V	A	12	9
		110V	A	4	4
		180V - 220V	A	1	1
	3 poles in series	24V - 60V	A	12	9
		110V	A	6	6
		180V - 220V	A	1	1
<b>Maximum ambient temperature</b>					
Operation	open	°C		-40 to +60 (+90) <sup>1)</sup>	
	enclosed	°C		-40 to +40	
with thermal overload relay	open	°C		-25 to +60	
	enclosed	°C		-25 to +40	
Storage		°C		-50 to +90	
<b>Short circuit protection</b>					
for contactors without thermal overload relay					
Rated short circuit current	"r" / "Iq"	kA		1	1
Coordination-type "1" according to IEC 947-4-1					
Contact welding without hazard of persons max. fuse size	gL (gG)	A		32	32
For contactors with thermal overload relay the device with the smaller admissible backup fuse (contactor or thermal overload relay) determines the fuse size.					
<b>Cable cross-sections</b>					
for contactors					
main connector	solid or stranded	mm <sup>2</sup>		0,5 - 1,5	Solder Connector
	flexible	mm <sup>2</sup>		0,5 - 1,5	Ø 1,15
Cables per clamp	flexible with multicore cable end	mm <sup>2</sup>		0,5 - 1,5	-
	solid or stranded	AWG		2	-
<b>Frequency of operation z</b>					
for contactors without thermal overload relay					
	without load	1/h		10000	10000
	AC3, I <sub>e</sub>	1/h		600	600
	AC4, I <sub>e</sub>	1/h		120	120
	DC3, I <sub>e</sub>	1/h		600	600
<b>Mechanical life</b>					
	AC operated	S x10 <sup>6</sup>		3	3
	DC operated	S x10 <sup>6</sup>		4	4
<b>Short time current</b>					
	10s-current	A		50	50
<b>Power loss per pole</b>					
	at I <sub>e</sub> /AC3 400V	W		0,2	0,2
<b>Resistance to shock according to IEC 68-2-27</b>					
Shock time 20ms sine-wave					
AC operated	NO	g		2,5	2,5
	NC	g		2,5	2,5

1) With reduced control voltage range 0,9 up to 1,0 x U<sub>s</sub> and with reduced rated current I<sub>e</sub>/AC1 according to I<sub>e</sub>/AC3.

# Micro Contactors

## Data according to IEC 60947-5-1, VDE 0660, EN 60947-5-1

Auxiliary Contacts			Type	K0-04D.. K0-05D..	K0-04L.. K0-05L..
<b>Rated insulation voltage</b>	<b>U<sub>i</sub></b>	VAC		440 <sup>1)</sup>	440 <sup>1)</sup>
<b>Thermal rated current I<sub>th</sub></b> to 440V					
Ambient temperature	40°C	A		5	5
	60°C	A		3	3
<b>Power loss</b> per pole	at I <sub>th</sub>	W		0,25	0,25
<b>Utilization category AC15</b>					
Rated operational current I <sub>e</sub>	220-240V	A		3	3
	380-415V	A		1,5	1,5
	440V	A		1	1
<b>Utilization category DC13</b>					
Rated operational current I <sub>e</sub>	24V	A		2	2
	60V	A		1,6	1,6
	110V	A		0,3	0,3
	180V	A		0,2	0,2
	220V	A		0,05	0,05
<b>Maximum ambient temperature</b>					
Operation	open	°C		-40 to +60 (+90) <sup>2)</sup>	
	enclosed	°C		-40 to +40	
Storage		°C		-40 to +90	
<b>Short circuit protection</b>					
short-circuit current 1kA, contact welding not accepted max. fuse size			gL (gG) A	10	10
For contactors with thermal overload relay the device with the smaller admissible control fuse (contactor or thermal overload relay) determines the fuse size.					
<b>Power consumption of coils</b>					
AC operated	inrush	VA		9	9
	sealed	VA		4	4
		W		1,8	1,8
DC operated	inrush	W		2,5	2,5
	sealed	W		2,5	2,5
<b>Operation range of coils</b>					
in multiples of control voltage U <sub>s</sub>		AC		0,85 - 1,1	0,85 - 1,1
		DC		0,8 - 1,1	0,8 - 1,1
<b>Switching time</b> at control voltage U <sub>s</sub> ±10% <sup>3) 4)</sup>					
AC operated	make time	ms		13 - 18	13 - 18
	release time	ms		5 - 10	5 - 10
	arc duration	ms		10 - 15	10 - 15
DC operated	make time	ms		10 - 40	10 - 40
	release time	ms		2 - 10	2 - 10
	arc duration	ms		10 - 15	10 - 15
<b>Cablecross-section</b>					
all connectors	solid	mm <sup>2</sup>		0,5 - 1,5	Solder Connector
	flexible	mm <sup>2</sup>		0,5 - 1,5	Ø 1,15
	flexible with multicore cable end	mm <sup>2</sup>		0,5 - 1,5	
Clamps per pole				2	-
	solid or stranded	AWG		20 - 14	-

1) Suitable at 690V for: earthed-neutral systems, overvoltage category I to III, pollution degree 3 (standard-industry); U<sub>imp</sub> = 4kV.  
Data for other conditions on request.

2) With reduced control voltage range 0,9 up to 1,0 x U<sub>s</sub> and with reduced thermal rated current I<sub>th</sub> to I<sub>e</sub>/AC15.

3) Summary switching time = release time + arc duration.

4) Release time of NC make time of NO increase when suppressor units for voltage peak protection are used (Varistor, RC-units, Diode units).

5) Data on request.

# Micro Contactors for North America

## Data according to UL508

Main Contacts (cULus)		Type	K0-05D.. K0W05D01..	K0-04D..	K0-05L..	K0-04L..
Rated operational current "General Use"		A	12	5	9	5
Rated operational power of three motors at 60Hz (3ph)	110-120V	hp	1/2	-	1/2	-
	200-208V	hp	1	-	1	-
	220-240V	hp	1	-	1	-
	277V	hp	1 1/2	-	1 1/2	-
	440-480V	hp	2 1/2	-	2 1/2	-
Rated operational power of AC motors at 60Hz (1ph / 2-pole break)	110-120V	hp	1/6	-	1/6	-
	200-208V	hp	1/3	-	1/3	-
	220-240V	hp	1/2	-	1/2	-
	277V	hp	3/4	-	3/4	-
	440-480V	hp	1	-	1	-
Fuse / Short-circuit current		A/kA	30/5	-	30/5	-
Rated voltage		VAC	480	480	480	480
<b>Auxiliary Contacts (cULus)</b>						
	heavy pilot duty	AC	B300	B300	B300	B300
	standard pilot duty	DC	R300	R300	R300	R300

### Motor Rating P<sub>n</sub> = AC4

440/ 380/ 220/  
460V 400V 230V  
kW kW kW

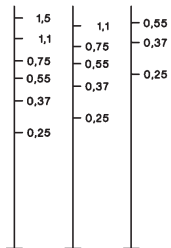

### Motor Rating P<sub>n</sub> = AC3

440/ 380/ 220/  
460V 400V 230V  
kW kW kW

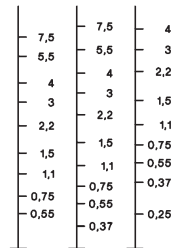

### Breaking Current I<sub>a</sub> (= I<sub>e</sub> = AC1) A

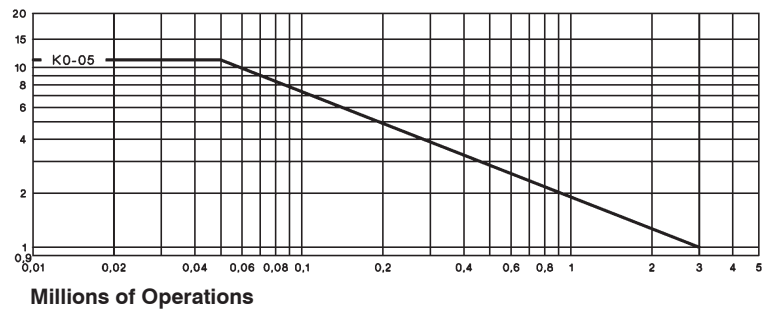

# Micro Contactors

## Dimensions

AC or DC operated  
with screw terminals

K0-04D.. (=)  
K0-05D.. (=)

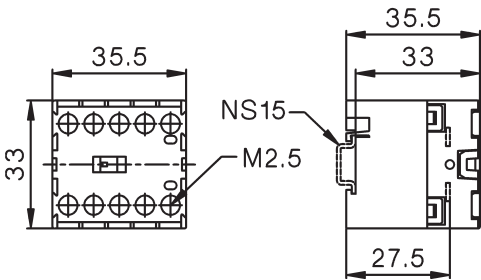

Snap-On Adapter P1039

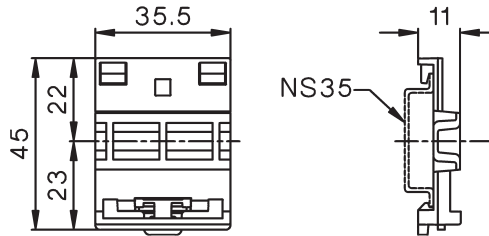

Reversing Contactors  
with screw terminals

K0W05D..MS

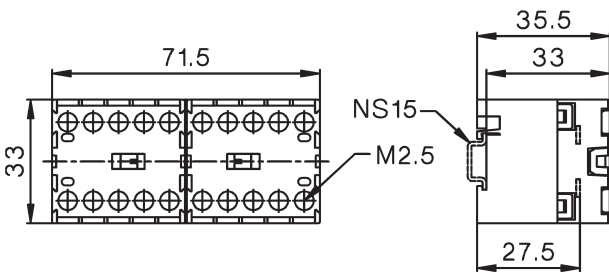

K0..D.. with Snap-On Adapter P1039

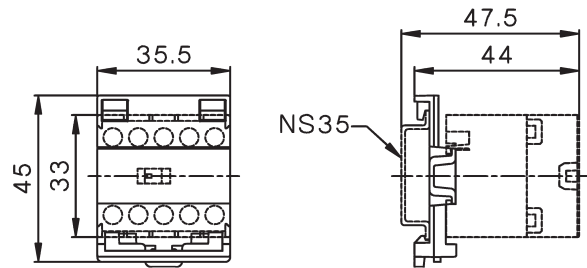

AC or DC operated  
with solder connections

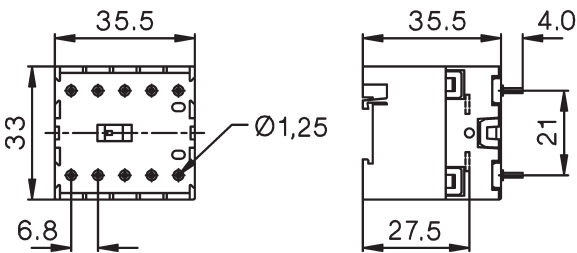

K0-04L.. (=)  
K0-05L.. (=)

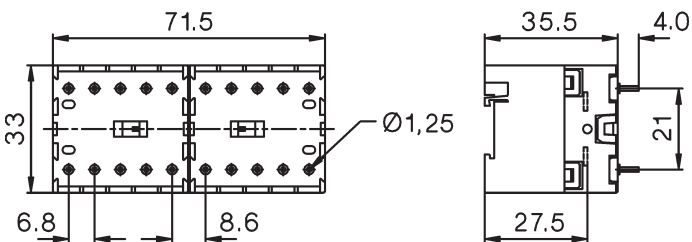

Reversing Contactors  
with solder connections

K0W05L..MS



	<p>Mini Contactor Relays 4-pole Auxiliary Contact Blocks</p>	<p>26</p>
	<p>Interface Contactor Relays</p>	<p>27</p>
	<p>Mini Contactors Auxiliary Contact Blocks</p>	<p>28</p>
	<p>Mini Contactors With Fast On Tab Connectors</p>	<p>30</p>
	<p>Mini Contactors With Solder Pins</p>	<p>30</p>
	<p>Coil voltages</p>	<p>30</p>
	<p>Mini Reversing Contactors Auxiliary Contact Blocks</p>	<p>32</p>
	<p>Technical Data</p>	<p>33</p>
	<p>Dimensions</p>	<p>38</p>

# Mini Contactor Relays 4-pole

AC Operated

Ratings	Therm. Distinc. Number	Contacts <sup>2)</sup> Additional Contact	Type	Coil voltage <sup>1)</sup>
<b>AC15</b>				24V 50/60Hz
<b>230V</b>				220-230V 50Hz
<b>A</b>				24V 50/60Hz w. protection <sup>3)</sup>
				220-230V 50Hz w. protection <sup>3)</sup>
				24V 50/60Hz 24V= DC <sup>3)</sup>
				220-240V 50/60Hz 220V= DC <sup>3)</sup>
				Pack Weight pcs. kg/pc.

## 4-pole, With Screw Terminals



3	2	10	4	-	40E	1 HK..	K1-07D40 ...	10	0,16
3	2	10	3	1	31E	1 HK..	K1-07D31 ...	10	0,16
3	2	10	2	2	22E	1 HK..	K1-07D22 ...	10	0,16

# Auxiliary Contact Blocks For Contactor Relays <sup>4)</sup>



Ratings	Thermal Rated Current	Contacts <sup>2)</sup> NO NC	Type	Pack pcs.	Weight kg/pc.		
<b>AC15</b>							
<b>230V</b>							
<b>A</b>							
3	2	10	1	1	HK11	10	0,04
3	2	10	-	2	HK02	10	0,04
3	2	10	2	-	HK20	10	0,04
3	2	10	4	-	HK40	10	0,04
3	2	10	2	2	HK22	10	0,04
3	2	10	-	4	HK04	10	0,04

Aux. Contact Blocks <sup>4)</sup>

Wiring Diagrams

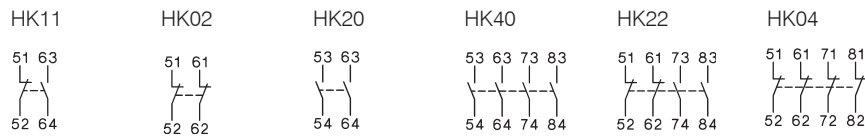

Distinc. Number according to EN50011 for Contactor Relay with Auxiliary Contact Block

K1-07D40	<b>51E</b>	<b>42E</b>	<b>60E</b>	<b>80E</b>	<b>62E</b>	<b>44E</b>
K1-07D31	42Y	33Y	51Y	71Y	53Y	35Y
K1-07D22	33Y	24Y	42Y	62Y	44Y	26Y

Preferable combinations with distinctive letter **..E** according to DIN EN 50011.

1) Other coil voltages see page 30.

2) Contacts suitable for electronic circuits, according to EN947-5-4 for rated voltage 24V DC (test ratings 17V DC, 5mA) Mirror contacts acc. IEC60947-4-1 Annex F...

3) with built-in coil suppressor (varistor)

4) Auxiliary Contact Blocks with NO and NC contacts for DC operated Contactor Relays have linked contacts.



# DC Solenoid Operated

Type	Coil voltage <sup>1)</sup>	Contacts <sup>2)</sup>		Additional Contact Blocks	Pack pcs.	Weight kg/pc.	Wiring Diagrams
	24 24VS ↓	24V= DC 24V= DC with protection <sup>2)</sup>	NO				

## 4-pole, With Screw Terminals, Coil 2,5W



<b>K1-07D40= ...</b>	4	-	40E	1 HK..	10	0,19
----------------------	---	---	-----	--------	----	------

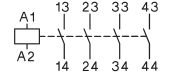

<b>K1-07D31= ...</b>	3	1	31E	1 HK..	10	0,19
----------------------	---	---	-----	--------	----	------

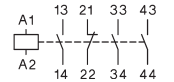

<b>K1-07D22= ...</b>	2	2	22E	1 HK..	10	0,19
----------------------	---	---	-----	--------	----	------

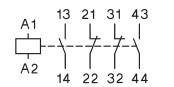

## 4-pole, With Screw Terminals, Coil 1,5W, 19 to 30V DC with suppressor <sup>3)</sup>



<b>K1-07D40= 24VR</b>	4	-	-	-	10	0,20
-----------------------	---	---	---	---	----	------

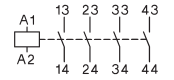

<b>K1-07D31= 24VR</b>	3	1	-	-	10	0,20
-----------------------	---	---	---	---	----	------

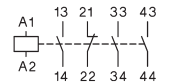

<b>K1-07D22= 24VR</b>	2	2	-	-	10	0,20
-----------------------	---	---	---	---	----	------

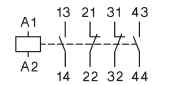

1) Other coil voltages on request

2) Contacts suitable for electronic circuits, according to EN947-5-4 for rated voltage 24V DC (test ratings 17V DC, 5mA)

Mirror contacts acc. IEC60947-4-1 Annex F...

Linked contacts acc. IEC60947-5-1 Annex L...



3) with integrated coil suppressor (Transient Voltage Suppressor Diode)

# Mini Contactors

# AC Operated

Power Ratings	Rated Current	Aux. Contacts <sup>2)</sup>		Type	Coil voltage <sup>1)</sup>	Pack pcs.	Weight kg/pc.
		Built-in	Additional				
AC2, AC3	AC1				24V 50/60Hz		
<b>380V</b>					220-230V 50Hz		
<b>400V</b>	660V				24V 50/60Hz w. protection <sup>3)</sup>		
<b>415V</b>	690V	690V			220-230V 50Hz w. protection <sup>3)</sup>		
<b>kW</b>	<b>kW</b>	<b>A</b>			24V = DC <sup>3)</sup>		
			NO NC	Type			



### 3-pole, With Screw Terminals

<b>4</b>	4	20	1	-	1 HKM..	<b>K1-09D10 ...</b>	10	0,16
<b>5,5</b>	5,5	20	1	-	1 HKM..	<b>K1-12D10 ...</b>	10	0,16

<b>4</b>	4	20	-	1	1HK..	<b>K1-09D01 ...</b>	10	0,16
<b>5,5</b>	5,5	20	-	1	1HK..	<b>K1-12D01 ...</b>	10	0,16

### 4-pole, With Screw Terminals

<b>4</b>	4	20	-	-	1HK..	<b>K1-09D00-40 ...</b>	10	0,16
<b>5,5</b>	5,5	20	-	-	1HK..	<b>K1-12D00-40 ...</b>	10	0,16

## Auxiliary Contact Blocks for Contactors K1-..<sup>4)</sup>

Ratings	Thermal Rated Current	Contacts <sup>2)</sup>		Type	Pack pcs.	Weight kg/pc.
		Built-in	Additional			
<b>AC15</b>						
<b>230V</b>	400V					
<b>A</b>	<b>A</b>	<b>A</b>	NO NC			
<b>3</b>	2	10	1 1	<b>HKM11</b>	10	0,04
<b>3</b>	2	10	- 2	<b>HKM02</b>	10	0,04
<b>3</b>	2	10	2 2	<b>HKM22</b>	10	0,04

Aux. Contact Blocks <sup>4)</sup>

HKM11

HKM02

HKM22

Wiring Diagrams

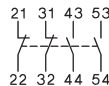

Contactors with Auxiliary Contact Block

Contacts according to EN50012

K1-..D10	<b>21</b>	<b>12</b>	<b>32</b>	-	-	-	-
----------	-----------	-----------	-----------	---	---	---	---

Contacts according to DIN EN50005

K1-..D01	-	-	-	12	03	41	23
K1-..D00-40	-	-	-	11	02	40	22

Prefer combinations according to EN50012.

HK.. Aux. Contact Blocks (page 26) fit on Mini-Contactors but do not meet the terminal markings acc. to EN50012.

## Suppressor Units for Contactors K1-..



Voltage Range V		Type	Pack pcs.	Weight kg/pc.
12 - 48V AC/DC	1600nF / 22 Ohm	<b>RC-K1 24</b>	10	0,01
48 - 127V AC/DC	680nF / 270 Ohm	<b>RC-K1 110</b>	10	0,01
110 - 250V AC/DC	220nF / 2200 Ohm	<b>RC-K1 230</b>	10	0,01

1) Other coil voltages see page 30

2) Contacts suitable for electronic circuits, according to EN947-5-4 for rated voltage 24V DC (test ratings 17V DC, 5mA)

Mirror contacts acc. IEC60947-4-1 Annex F...

3) with built-in coil suppressor (varistor)



4) Auxiliary Contact Blocks with NO and NC contacts for DC operated Mini-Contactors have linked contacts...

# DC Solenoid Operated

## Type

Coil voltage <sup>1)</sup>  
**24** 24V= DC  
**24VS** 24V= DC with protection <sup>3)</sup>



Aux. Contacts <sup>2)</sup>  
 Built in Additional  
   
 NO NC

Additional Overload Relay  
 see page 114  
 Type

Pack pcs. Weight kg/pc.

Wiring Diagrams



### 3-pole, With Screw Terminals, Coil 2,5W

<b>K1-09D10= ...</b>	1	-	1 HKM..	U12/16..K1	10	0,19
<b>K1-12D10= ...</b>	1	-	1 HKM..	U12/16..K1	10	0,19

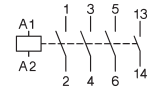

<b>K1-09D01= ...</b>	-	1	1 HK..	U12/16..K1	10	0,19
<b>K1-12D01= ...</b>	-	1	1 HK..	U12/16..K1	10	0,19

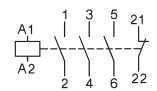

### 4-pole, With Screw Terminals, Coil 2,5W

<b>K1-09D00-40= ...</b>	-	-	-	U12/16..K1	10	0,19
<b>K1-12D00-40= ...</b>	-	-	-	U12/16..K1	10	0,19

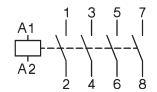

### 3-pole, With Screw Terminals, Coil 1,5W, 19 to 30V DC with suppressor <sup>3)</sup>

<b>K1-09D10=24VR</b>	1	-	-	U12/16..K1	10	0,20
----------------------	---	---	---	------------	----	------

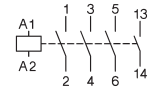

<b>K1-09D01= 24VR -</b>	-	1	-	U12/16..K1	10	0,20
-------------------------	---	---	---	------------	----	------

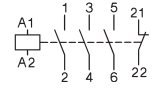

1) Other coil voltages on request

2) Contacts suitable for electronic circuits, according to EN947-5-4 for rated voltage 24V DC (test ratings 17V DC, 5mA)

Mirror contacts acc. IEC60947-4-1 Annex F... 

3) with integrated coil suppressor (Transient Voltage Suppressor Diode)

# Mini Contactors

# AC Operated

Power Ratings	Rated Current	Aux. Contacts <sup>2)</sup>		Type	Coil voltage <sup>1)</sup>
		Built in	Additional		
AC2, AC3	AC1				24V 50/60Hz
<b>380V</b>					220-230V 50Hz
<b>400V</b>	660V				24V 50/60Hz w. protection <sup>3)</sup>
<b>415V</b>	690V	690V			220-230V 50Hz w. protection <sup>3)</sup>
<b>kW</b>	kW	A	NO NC	Type	24V DC
					220-240V 50/60Hz 220V DC
					Pack Weight
					pcs. kg/pc.

### 3-pole, with Fast On Tab Connectors 1 x 6,3mm or 2 x 2,8mm



4	4	16	1	-	1 HKM..	<b>K1-09F10</b> ...	10	0,16
4	4	16	-	1	1 HK..	<b>K1-09F01</b> ...	10	0,16

### 3-pole, with Solder Pins Ø1,15 for Printed Circuit Applications



4	4	16	1	-	-	<b>K1-09L10</b> ...	10	0,16
4	4	16	-	1	-	<b>K1-09L01</b> ...	10	0,16

### 4-pole, with Solder Pins Ø1,15 for Printed Circuit Applications

4	4	16	-	-	-	<b>K1-09L00-40</b> ...	10	0,16
---	---	----	---	---	---	------------------------	----	------

## Coil voltages for AC operated contactors

Suffix to contactor type e.g. K1-09D10 24	Voltage Marking at the coil		Rated Control Voltage U <sub>s</sub> range			
	for 50Hz	for 60Hz	for 50Hz		for 60Hz	
	V	V	min.	max.	min.	max.
12	12	12	11	12	12	12
<b>24</b>	<b>24</b>	<b>24</b>	<b>22</b>	<b>24</b>	<b>24</b>	<b>24</b>
42	42	42	38,5	42	42	42
48	48	48	48	50	48	52
90	100	100	90	100	100	105
95	95-100	105-110	95	100	105	110
100	100	110-115	100	105	110	115
105	105-110	115-120	105	110	115	120
110	110-115	120-125	110	115	120	125
180	200	200	185	200	200	210
190R <sup>4)</sup>	200-240	200-240	200	240	200	240

Suffix to contactor type e.g. K1-09D10 230	Voltage Marking at the coil		Rated Control Voltage U <sub>s</sub> range			
	for 50Hz	for 60Hz	for 50Hz		for 60Hz	
	V	V	min.	max.	min.	max.
200	200	200-220	195	205	200	220
210	205-215	220-230	205	215	220	230
220	210-220	220-240	210	220	220	240
<b>230</b>	<b>220-230</b>	<b>230-250</b>	<b>220</b>	<b>230</b>	<b>230</b>	<b>250</b>
240	230-240	240-260	230	240	240	260
400	380-400	400-440	380	400	400	440
500	475-500	520-545	475	500	520	545
550	525-550	600	525	550	570	600

**Standard voltages in bold type letters**  
**Operating range of magnet-coils: 0,85 x U<sub>s</sub> (min. value of rated control voltage) up to 1,1 x U<sub>s</sub> (max. value of rated control voltage)**

Coil not exchangeable

1) Other coil voltages see page 28



2) Contacts suitable for electronic circuits, according to EN947-5-4 for rated voltage 24V DC (test ratings 17V DC, 5mA) Mirror contacts acc. IEC60947-4-1 Annex F.

3) with built-in coil suppressor (varistor)

4) Reduction of mechanical life to 25% of normal life. It is not admissible as a spare coil in a contactor with different coil voltages.

# DC Solenoid Operated

## Type

Coil voltage <sup>1)</sup>	Aux. Contacts <sup>2)</sup>	Additional	Pack	Weight
<b>24</b> 24V= DC	Built	Overload	pcs.	kg/pc.
<b>24VS</b> 24V= DC with protection <sup>3)</sup>	in	Relay see pages 115, 117		
↓	 	Type		
	NO NC			



### 3-pole, with Fast On Tab Connectors 1 x 6,3mm or 2 x 2,8mm

<b>K1-09F10= . . .</b>	1	-	1 HKM.. <sup>4)</sup>	10	0,19
------------------------	---	---	-----------------------	----	------

Wiring Diagrams

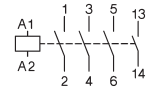

<b>K1-09F01= . . .</b>	-	1	1 HK.. <sup>4)</sup>	10	0,19
------------------------	---	---	----------------------	----	------

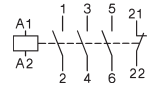

### 3-pole, with Solder Pins Ø1,15 for Printed Circuit Applications

<b>K1-09L10= . . .</b>	1	-	-	10	0,19
------------------------	---	---	---	----	------

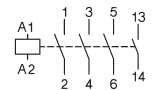

<b>K1-09L01= . . .</b>	-	1	-	10	0,19
------------------------	---	---	---	----	------

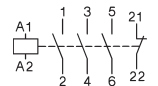

### 4-pole, with Solder Pins Ø1,15 for Printed Circuit Applications

<b>K1-09L00-40= . . .</b>	-	-	-	10	0,19
---------------------------	---	---	---	----	------

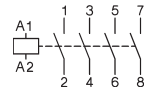

1) Other coil voltages on request  
 2) Contacts suitable for electronic circuits, according to EN947-5-4 for rated voltage 24V DC (test ratings 17V DC, 5mA) Mirror contacts acc. IEC60947-4-1 Annex F.  
 3) with integrated coil suppressor (Transient Voltage Suppressor Diode)  
 4) U12/16E K3 with U12SMK3 for single mounting

# Mini Reversing Contactors, Mechanical Interlocked

AC Operated

Power Ratings	Rated Current	AC1	Aux. Contacts <sup>2)</sup>		Type	Coil voltage <sup>1)</sup>	Pack pcs.	Weight kg/pc.
			Built-in	Additional on left hand side Contactor				
AC2, AC3						24V 50/60Hz		
<b>380V</b>						220-230V 50Hz		
<b>400V</b>	660V					24V 50/60Hz w. protection <sup>3)</sup>		
<b>415V</b>	690V	690V				220-230V 50Hz w. prot. <sup>3)</sup>		
<b>kW</b>	<b>kW</b>	<b>A</b>				24V 50/60Hz 24V DC		
			NO NC	K1 Type	K2 Type	220-240V 50/60Hz 220V DC		

## 3-pole, with Screw Terminals



<b>4</b>	4	20	-	2	HKM11V	HKM11X	<b>K1W09D01MC ...</b>	1	0,32
<b>5,5</b>	5,5	20	-	2	HKM11V	HKM11X	<b>K1W12D01MC ...</b>	1	0,32
<b>4</b>	4	20	2	-	HKM..		<b>K1W09D10MC ...</b>	1	0,32
<b>5,5</b>	5,5	20	2	-	HKM..		<b>K1W12D10MC ...</b>	1	0,32

## 4-pole, with Screw Terminals

<b>4</b>	4	20	-	-	HKM..		<b>K1W09D00-40MC ..</b>	1	0,32
<b>5,5</b>	5,5	20	-	-	HKM..		<b>K1W12D00-40MC ..</b>	1	0,32

## 3-pole, with Solder Pins Ø1,15 for Printed Circuit Applications

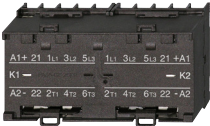

<b>4</b>	4	16	-	2	-	-	<b>K1W09L01MC ...</b>	1	0,32
<b>4</b>	4	16	2	-	-	-	<b>K1W09L10MC ...</b>	1	0,32

# Auxiliary Contact Blocks for Mini Reversing Contactors K1-..

Ratings	AC15	400V	Thermal Rated Current	Contacts <sup>2)</sup>		Type	Pack pcs.	Weight kg/pc.
				NO	NC			
<b>3</b>	2		10	1	1	<b>HKM11V</b>	10	0,04
<b>3</b>	2		10	1	1	<b>HKM11X</b>	10	0,04



Aux. Contact Blocks

HKM11V      HKM11X

Wiring Diagrams

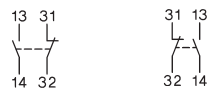

# Reversing Starter Connector



For Reversing Starter Types, incl. Coil Connector

Type	Pack pcs.	Weight kg/pc.
<b>K1W09D..MC, K1W12D..MC</b>	<b>1</b>	<b>0,01</b>

1) Other coil voltages see page 30  
 2) Contacts suitable for electronic circuits, according to EN947-5-4 for rated voltage 24V DC (test ratings 17V DC, 5mA) Mirror contacts acc. IEC60947-4-1 Annex F.  
 3) with built-in coil suppressor (varistor)

# DC Solenoid Operated

## Type

**24** Coil voltage <sup>1)</sup>  
**24VS** 24V= DC  
 ↓ 24V= DC with protection <sup>2)</sup>

Additional  
 Overload  
 Relay  
 see  
 page 114  
 Type

Pack pcs. Weight kg/pc.

Wiring Diagrams



### 3-pole, with Screw Terminals

K1W09D01MC= ...	U12/16..K1	1	0,32
K1W12D01MC= ...	U12/16..K1	1	0,32

K1W09D10MC= ...	U12/16..K1	1	0,32
K1W12D10MC= ...	U12/16..K1	1	0,32

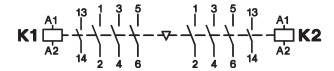
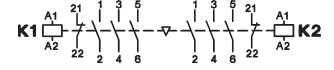

### 4-pole, with Screw Terminals

K1W09D00-40MC= ..	U12/16..K1	1	0,32
K1W12D00-40MC= ..	U12/16..K1	1	0,32

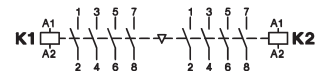

### 3-pole, with Solder Pins Ø1,15 for Printed Circuits Applications



K1W09L01MC= ...	-	1	0,32
-----------------	---	---	------

K1W09L10MC= ...	-	1	0,32
-----------------	---	---	------

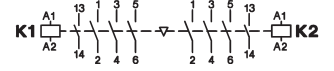
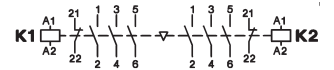

1) Other coil voltages on request  
 2) with integrated coil suppressor (Transient Voltage Suppressor Diode)

# Mini Contactors

Data according to IEC 947-4-1, VDE 0660, EN 60947-4-1

Main Contacts	Type	K1-09D..	K1-09F..	K1-09L..	K1-12D..
<b>Rated insulation voltage <math>U_i</math></b>	V AC	690 <sup>1)</sup>	690 <sup>1)</sup>	690 <sup>2)</sup>	690 <sup>1)</sup>
<b>Making capacity <math>I_{eff}</math></b>	at $U_e = 690V$ AC	A	165	165	165
<b>Breaking capacity <math>I_{eff}</math></b>	400V AC	A	100	100	100
$\cos\varphi = 0,65$	500V AC	A	90	90	90
	690V AC	A	80	80	80
<b>Utilization category AC1</b>					
<b>Switching of resistive load</b>					
Rated operational current $I_e (=I_{th})$ at 40°C, open	<b>A</b>	<b>20</b>	<b>16</b>	<b>16</b>	<b>20</b>
Rated operational power of three-phase resistive loads					
50-60Hz, $\cos\varphi = 1$	230V kW	7,9	6	6	7,9
	240V kW	8,3	6,5	6,5	8,3
	400V kW	13,8	11	11	13,8
	415V kW	14,3	11,5	11,5	14,3
Rated operational current $I_e (=I_{the})$ at 60°C, enclosed	A	16	12	12	16
Rated operational power of three-phase resistive loads					
50-60Hz, $\cos\varphi = 1$	230V kW	6,3	4,5	4,5	6,3
	240V kW	6,7	5	5	6,7
	400V kW	11	8	8	11
	415V kW	11,5	8,5	8,5	11,5
Minimum cross-section of conductor at load with $I_e (=I_{th})$	mm <sup>2</sup>	2,5	2,5	-	2,5
<b>Utilization category AC2 and AC3</b>					
<b>Switching of three-phase motors</b>					
Rated operational current $I_e$					
open and enclosed	220V A	12	12	12	15
	230V A	11,5	11,5	11,5	14,5
	240V A	11	11	11	14
	<b>380-400V A</b>	<b>9</b>	<b>9</b>	<b>9</b>	<b>12</b>
	415-440V A	8	8	8	11
	500V A	7	7	7	9
	660-690V A	5	5	5	6,5
Rated operational power of three-phase motors					
50-60Hz	220-240V kW	3	3	3	4
	<b>380-440V kW</b>	<b>4</b>	<b>4</b>	<b>4</b>	<b>5,5</b>
	500-690V kW	4	4	4	5,5
<b>Utilization category AC4</b>					
<b>Switching of squirrel cage motors, inching</b>					
Rated operational current $I_e$					
open and enclosed	220V A	12	12	12	15
	230V A	11,5	11,5	11,5	14,5
	240V A	11	11	11	14
	<b>380-400V A</b>	<b>9</b>	<b>9</b>	<b>9</b>	<b>12</b>
	415-440V A	8	8	8	11
	500V A	7	7	7	9
	660-690V A	5	5	5	6,5
Rated operational power of three-phase motors					
50-60Hz	220-240V kW	3	3	3	4
	<b>380-440V kW</b>	<b>4</b>	<b>4</b>	<b>4</b>	<b>5,5</b>
	500-690V kW	4	4	4	5,5
<b>Utilization category AC5a</b>					
<b>Switching of gas discharge lamps</b>					
Rated operational current $I_e$					
per pole at 220/230V					
Fluorescent lamps,					
uncompensated and serial compensated	A	10	10	10	10
parallel compensated	A	2	2	2	2
dual-connection	A	16	16	16	16
Metal halide lamps <sup>3)</sup> ,					
uncompensated	A	10	10	10	10
parallel compensated	A	2	2	2	2
Mercury-vapour lamps <sup>4)</sup> ,					
uncompensated	A	16	16	16	16
parallel compensated	A	2	2	2	2
Mixed light lamps <sup>5)</sup>	A	16	16	16	16
<b>LED-Lamps</b>					
consider the inrush current of the lamp ballast					
and $\cos\varphi$ of the lamp	max. lamps per pole ( $I_{nLED} \leq I_{th}$ )	=	inrush current of contactor		
			inrush current of lamp/EVG		
max inrush current of contactor	A	233	233	233	233

## Utilization category AC5b Switching of incandescent lamps <sup>6)</sup>

Rated operational current $I_e$					
per pole at 220/230V	A	8	8	8	8
1) Suitable at 690V for: earthed-neutral systems, overvoltage category I to IV, pollution degree 3 (standard-industry); $U_{imp} = 8kV$ . Data for other conditions on request. 2) Suitable at 690V for pollution degree 2, $U_{imp} = 6kV$ . Pollution degree 3 $U_i = 690V$ non-tracking of the printed circuit CTI $\geq 600$ Pollution degree 3 $U_i = 500V$ non-tracking of the printed circuit CTI $\geq 400$ Pollution degree 3 $U_i = 400V$ non-tracking of the printed circuit CTI $\geq 100$ 3) Metal halide lamps and sodium-vapour lamps (high- and low-pressure lamps) 4) High-pressure lamps 5) Blended lamps, containing a mercury high-pressure unit and a tungsten helix in a fluorescent glass bulb (daylight lamps) 6) Current inrush approx. $16 \times I_e$					

# Mini Contactors

Data according to IEC 947-4-1, VDE 0660, EN 60947-4-1

Main Contacts	Type	K1-09D..	K1-09F..	K1-09L..	K1-12D..	
<b>Utilization category DC1</b>						
<b>Switching of resistive load</b>	1 pole 24V - 60V	A	20	16	16	20
Time constant L/R ≤1ms	110V	A	5	5	5	5
Rated operational current I <sub>e</sub>	220V	A	0,6	0,6	0,6	0,6
	2 poles in series 24V - 110V	A	20	16	16	20
	220V	A	5	5	5	5
	3 poles in series 24V - 110V	A	20	20	20	20
	220V	A	16	16	16	16
<b>Utilization category DC3 and DC5</b>						
<b>Switching of shunt motors and series motors</b>	1 pole 24V	A	20	16	16	20
	60V	A	5	5	5	5
Time constant L/R ≤15ms	110V	A	1	1	1	1
Rated operational current I <sub>e</sub>	220V	A	0,15	0,15	0,15	0,15
	2 poles in series 24V - 60V	A	20	16	16	20
	110V	A	5	5	5	5
	220V	A	1	1	1	1
	3 poles in series 24V - 110V	A	20	16	16	20
	220V	A	2	2	2	2
<b>Maximum ambient temperature</b>						
Operation	open	°C	-40 to +60 (+90) <sup>1)</sup>			
	enclosed	°C	-40 to +40			
with thermal overload relay	open	°C	-25 to +60			
	enclosed	°C	-25 to +40			
Storage		°C	-50 to +90			
<b>Short circuit protection</b> for contactors without O/L relay						
Rated short circuit current	"r" / "Iq"	kA	3	3	3	3
Coordination-type "1" according to IEC 947-4-1						
Contact welding without hazard of persons	max. fuse size	gL (gG)	A	40	40	40
Coordination-type "2" according to IEC 947-4-1						
Light contact welding accepted	max. fuse size	gL (gG)	A	25	25	25
Contact welding not accepted	max. fuse size	gL (gG)	A	10	10	10
For contactors with thermal overload relay the device with the smaller admissible backup fuse (contactor or thermal overload relay) determines the fuse size.						
<b>Cable cross-sections</b>						
for contactors without thermal overload relay						
main connector	solid or stranded	mm <sup>2</sup>	0,5 - 2,5	Fast on	Solder connector	0,5 - 2,5
	flexible	mm <sup>2</sup>	0,5 - 2,5	1x 6,3 x 0,8	Ø 1,15	0,5 - 2,5
	flexible with multicore cable end	mm <sup>2</sup>	0,5 - 1,5	or	-	0,5 - 1,5
Cables per clamp			2	2x 2,8 x 0,8		2
	solid or stranded	AWG	18 - 14			18 - 14
<b>Frequency of operations z</b>						
without load 1/h						
10000	10000	10000	10000	10000	10000	
Contactors without thermal overload relay						
AC3, I <sub>e</sub>	1/h	600	600	600	700	
AC4, I <sub>e</sub>	1/h	120	120	120	150	
DC3, I <sub>e</sub>	1/h	600	600	600	700	
<b>Mechanical life</b>						
AC operated	S x	10 <sup>6</sup>	5	5	5	5
DC operated	S x	10 <sup>6</sup>	15	15	15	15
<b>Short time current</b>						
10s-current	A	96	96	96	120	
<b>Power loss</b> per pole						
at I <sub>e</sub> /AC3 400V	W	0,15	0,15	0,15	0,25	
<b>Resistance to shock according to IEC 68-2-27</b>						
Shock time 20ms sine-wave						
AC operated	NO	g	5	5	5	5
	NC	g	5	5	5	5
DC operated	NO	g	8	8	8	8
	NC	g	6	6	6	6

1) With reduced control voltage range 0,9 up to 1,0 x U<sub>s</sub> and with reduced rated current I<sub>e</sub>/AC1 according to I<sub>e</sub>/AC3

# Mini Contactors

## Data according to IEC 947-5-1, VDE 0660, EN 60947-5-1

Auxiliary Contacts			Type	K1-07D.. K1-09D.. K1-12D..	K1-07D..=(VM) K1-09D..=(VM) K1-12D..=(VM)	K1-07D..= 24VR K1-09D..= 24VR	K1-09F..=(VM)	K1-07L..=(VM) K1-09L..=(VM)	HK..
<b>Rated insulation voltage U<sub>i</sub></b>			V AC	690 <sup>1)</sup>	690 <sup>1)</sup>	690 <sup>1)</sup>	690 <sup>1)</sup>	690 <sup>2)</sup>	690 <sup>1)</sup>
<b>Thermal rated current I<sub>th</sub></b> to 690V									
Ambient temperature			40°C A	10	10	10	10	10	10
			60°C A	6	6	6	6	6	6
<b>Power loss</b> per pole			at I <sub>th</sub> W	0,5	0,5	0,5	0,5	0,5	0,5
<b>Utilization category AC15</b>									
Rated operational current I <sub>e</sub>			220-240V A	3	3	3	3	3	3
			380-415V A	2	2	2	2	2	2
			440V A	1,6	1,6	1,6	1,6	1,6	1,6
			500V A	1,2	1,2	1,2	1,2	1,2	1,2
			660-690V A	0,6	0,6	0,6	0,6	0,6	0,6
<b>Utilization category DC13</b>									
Rated operational current I <sub>e</sub>			60V A	2	2	2	2	2	2
			110V A	0,4	0,4	0,4	0,4	0,4	0,4
			220V A	0,1	0,1	0,1	0,1	0,1	0,1
<b>Maximum ambient temperature</b>									
Operation			open °C	-40 to +60 (+90) <sup>3)</sup>					
			enclosed °C	-40 to +40					
Storage			°C	-40 to +90					
<b>Short circuit protection</b>									
short-circuit current 1kA, contact welding not accepted max. fuse size			gL (gG) A	20	20	20	20	20	20
For contactors with thermal overload relay the device with the smaller admissible control fuse (contactor or thermal overload relay) determines the fuse size.									
<b>Power consumption of coils</b>									
AC operated			inrush VA	25	-	-	25	25	-
			sealed VA	4 - 5	-	-	4 - 5	4 - 5	-
			W	1,2	-	-	1,2	1,2	-
DC operated			inrush W	-	2,5	1,5	2,5	2,5	-
and ...VM (AC/DC)			sealed W	-	2,5	1,5	2,5	2,5	-
<b>Operation range of coils</b>									
in multiples of control voltage U <sub>s</sub>				0,85 - 1,1	0,8 - 1,1	19 - 30V DC	0,85 - 1,1	0,85 - 1,1	-
<b>Switching time</b> at control voltage U <sub>s</sub> ± 10% <sup>4) 5)</sup>									
AC operated			make time ms	15 - 19	-	-	15 - 19	15 - 19	-
			release time ms	8 - 25	-	-	8 - 25	8 - 25	-
			arc duration ms	10 - 15	-	-	10 - 15	10 - 15	-
DC operated			make time ms	-	15 - 50	15 - 50	15 - 50	15 - 50	-
			release time ms	-	8 - 25	8 - 25	8 - 25	8 - 25	-
			arc duration ms	-	10 - 15	10 - 15	10 - 15	10 - 15	-
<b>Cable cross-section</b>									
all connectors			solid mm <sup>2</sup>	0,5 - 2,5	0,5 - 2,5	0,5 - 2,5	Fast on	Solder connector	0,5 - 2,5
			flexible mm <sup>2</sup>	0,5 - 2,5	0,5 - 2,5	0,5 - 2,5	1x 6,3 x 0,8	Ø 1,15	0,5 - 2,5
			flexible with multicore cable end mm <sup>2</sup>	0,5 - 1,5	0,5 - 1,5	0,5 - 1,5	or		0,5 - 1,5
							2x 2,8 x 0,8		
Clamps per pole				2	2	2	-	-	2
			solid or stranded AWG	18 - 14	18 - 14	18 - 14			18 - 14

1) Suitable at 690V for: earthed-neutral systems, overvoltage category I to IV, pollution degree 3 (standard-industry): U<sub>imp</sub> = 8kV.  
Data for other conditions on request.

2) Suitable at 690V for pollution degree 2, U<sub>imp</sub> = 6kV.  
Pollution degree 3 U<sub>i</sub> = 690V non-tracking of the printed circuit CTI ≥ 600  
Pollution degree 3 U<sub>i</sub> = 500V non-tracking of the printed circuit CTI ≥ 400  
Pollution degree 3 U<sub>i</sub> = 400V non-tracking of the printed circuit CTI ≥ 100

3) With reduced control voltage range 0,9 up to 1,0 x U<sub>s</sub> and with reduced thermal rated current I<sub>th</sub> to I<sub>e</sub>/AC15

4) Summary switching time = release time + arc duration

5) Release time of NC make time of NO increase when suppressor units for voltage peak protection are used (Varistor, RC-units, Diode units).

# Mini Contactors for North America

## Data according to UL508

Main Contacts (cULus)		Type	K1-09D.. K1W09D01	K1-09F..	K1-09L..	K1-07D..	K1-12D.. K1W12D01	HK..
Rated operational current "General Use"		A	15	15	20	10	20	10
Rated operational power of three-phase motors at 60Hz (3ph)	110-120V	hp	1½	1½	1½	-	2	-
	200-208V	hp	3	3	3	-	3	-
	220-240V	hp	3	3	3	-	3	-
440-480V	hp	5	5	5	-	7½	-	
	550-600V	hp	7½	7½	7½	-	10	-
Rated operational power of AC motors at 60Hz (1ph / 2-pole break)	110-120V	hp	½	½	½	-	¾	-
	200-208V	hp	1	1	1	-	1½	-
	220-240V	hp	1½	1½	1½	-	2	-
Fuse / Short-circuit current		A/kA	30/5	30/5	30/5	-	30/5	-
Rated voltage		V AC	600	600	600 <sup>1)</sup>	600	600	600
<b>Auxiliary Contacts (cULus)</b>		heavy pilot duty	AC	A600	A600	A600	A600	A600
		standard pilot duty	DC	Q600	Q600	Q600	Q600	Q600

### Motor Rating P<sub>n</sub> = AC4

660/690V	500V	380/400V	220/230V
kW	kW	kW	kW
110	75	55	30
90	55	45	22
75	45	37	18,5
55	37	30	15
45	30	22	11
37	22	18,5	7,5
30	18,5	15	5,5
22	15	11	4
18,5	11	7,5	3
15	7,5	5,5	2,2
11	5,5	4	1,5
7,5	4	3	1,1
5,5	3	2,2	0,75
4	2,2	1,5	0,55
3	1,5	1,1	0,37
2,2	1,1	0,75	0,25
1,5	0,75	0,55	
1,1	0,55	0,37	
0,75	0,37	0,25	
0,55	0,25		
0,37			
0,25			

### Motor Rating P<sub>n</sub> = AC3

660/690V	500V	380/400V	220/230V
kW	kW	kW	kW
600	400	315	200
600	315	250	160
400	250	200	132
315	200	160	110
250	160	132	90
200	132	110	75
160	110	90	55
132	90	75	45
110	75	55	37
90	55	45	30
75	45	37	22
55	37	30	18,5
45	30	22	15
37	22	18,5	11
30	18,5	15	7,5
22	15	11	5,5
18,5	11	7,5	4
15	7,5	5,5	3
11	5,5	4	2,2
7,5	4	3	1,5
5,5	3	2,2	1,1
4	2,2	1,5	0,75
3	1,5	1,1	0,55
2,2	1,1	0,75	0,37
1,5	0,75	0,55	0,25
1,1	0,55	0,37	
0,75	0,37	0,25	
0,55	0,25		
0,37			
0,25			

### Breaking Current I<sub>a</sub> (= I<sub>e</sub> = AC1)

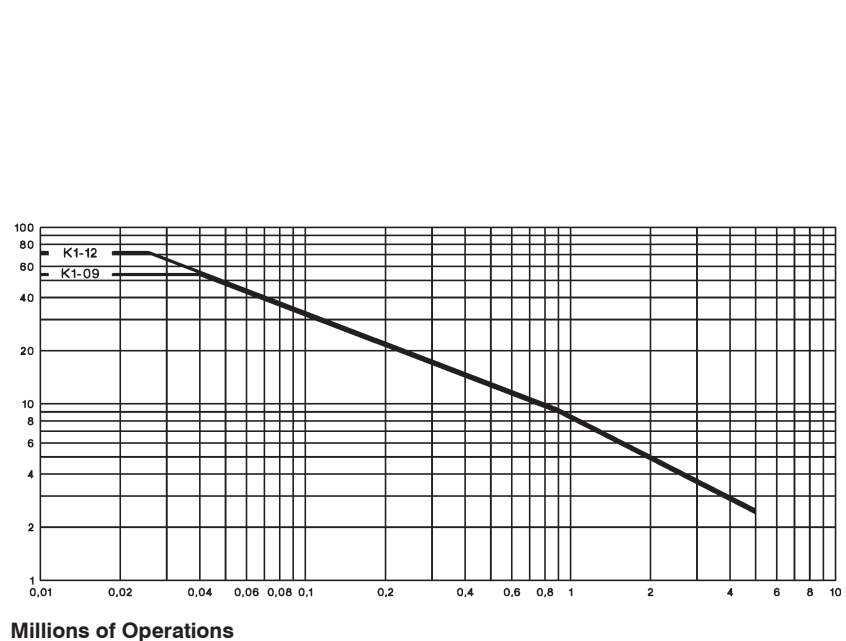

1) Pollution degree	CTI - PWB	U <sub>i</sub>
2	≥ 100	600V
3	≥ 400	480V
3	100 - 400	240V

# Mini Contactors

## Dimensions

**AC and DC operated**  
with screw terminals

**K1-07D..**  
**K1-09D..**  
**K1-12D..**

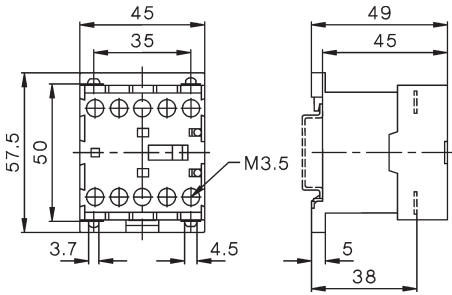

with fast on terminals

**K1-07F..**  
**K1-09F..**

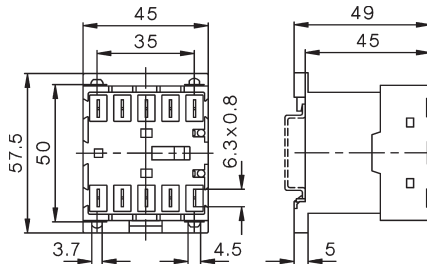

**AC and DC operated**  
with solder connections

**K1-07L..**  
**K1-09L..**

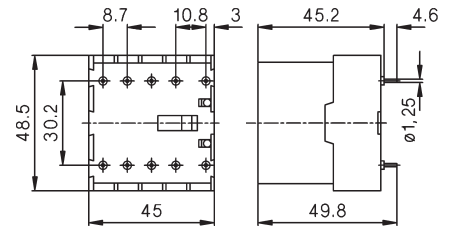

## Auxiliary Contact Blocks

**HK..**

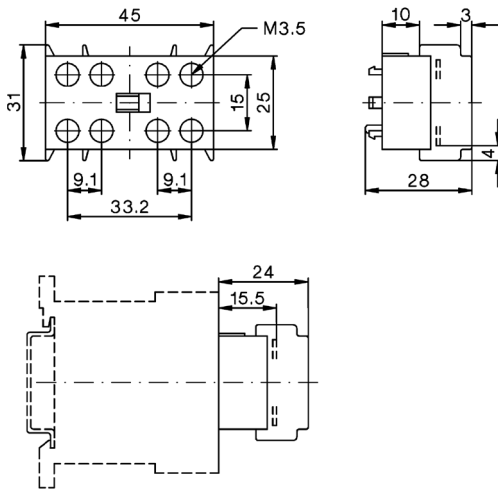

## Suppressor Units

**RC-K1**

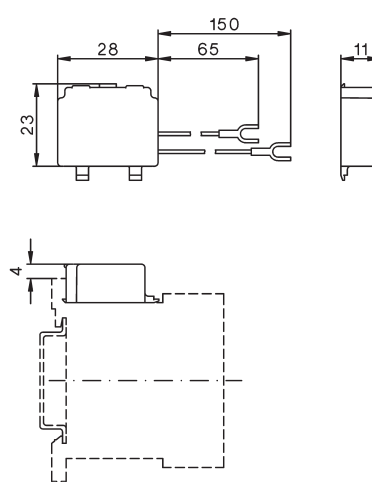

## Reversing Contactors

**K1W09D..MC**  
**K1W12D..MC**

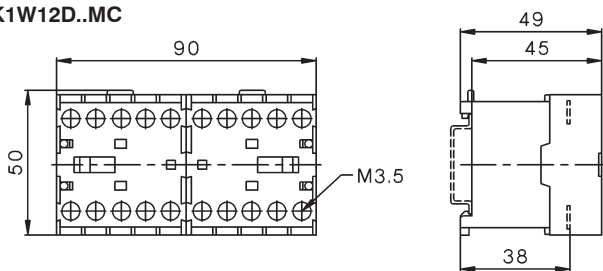

## Reversing Contactors

**K1W09L..MC**

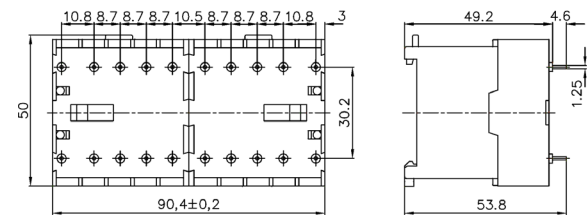

**K1-09 + U12/16.. K1**  
**K1-12**

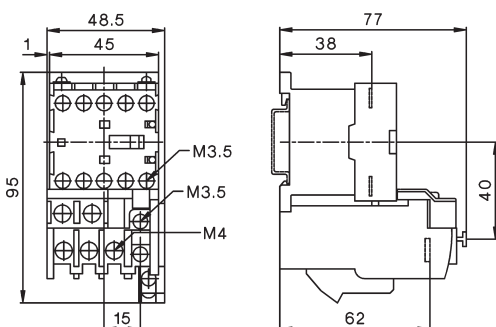

**K1W09D..MC + U12/16E K1**  
**K1W12D..MC + U12/16E K1**

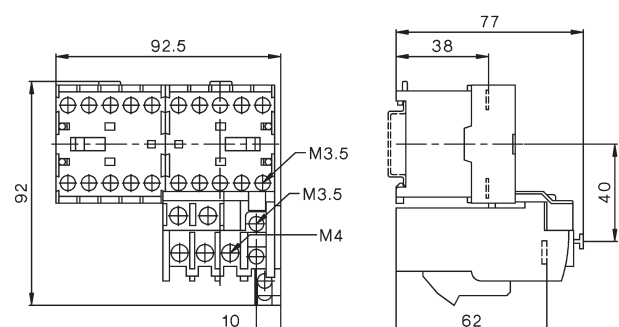



Contactor Relays 4-pole, AC Operated

40



Auxiliary Contact Blocks 1-pole

40



Contactor Relays 4-pole, DC Operated

41



Technical Data

42



Dimensions

44

## Contactors Relays

## AC Operated

Ratings		Contacts				Type	Coil voltage <sup>1)</sup>					
AC15	Therm. Rated Current	Built-in	Distinc. Number acc. to	Additional Contact Blocks		24	110	230	400			
230V	A	$I_{th}$	NO	NC	EN50011	Type	24V 50/60Hz	110V 50Hz	110-120V 60Hz	220-240V 50Hz	230-264V 60Hz	400-440V 60Hz
A	A	A										Pack Weight pcs. kg/pc.



### 4-pole, contacts suitable for electronic circuits according to EN947-5-4<sup>2)</sup>

4	2	10	4	-	40E	max. 4	K3-07ND40 ...	1	0,22
4	2	10	3	1	31E	HN..	K3-07ND31 ...	1	0,22
4	2	10	2	2	22E	max. 2	K3-07ND22 ...	1	0,22
4	2	10	-	4	04E	HB..	K3-07ND04 ...	1	0,22

## Auxiliary Contact Blocks <sup>3)</sup>

Ratings		Contacts <sup>2)</sup>				Type	Pack Weight
AC15	Thermal Rated Current	Built-in	Distinc. Number acc. to	Additional Contact Blocks			pcs. kg/pc.
230V	A	$I_{th}$	NO	NC	EM	LB	
A	A	A					



### 1-pole, contacts suitable for electronic circuits according to EN947-5-4<sup>2)</sup>

3	2	10	1	-	-	-	HN10	10	0,02
3	2	10	-	1	-	-	HN01	10	0,02
3	2	10	-	-	1	-	HN10U	10	0,02
3	2	10	-	-	-	1	HN01U	10	0,02

### 1-pole, for high switching capacity

6	3	25	1	-	-	-	HA10	10	0,03
6	3	25	-	1	-	-	HA01	10	0,03

Accessories see pages 52 - 55.

1) Other coil voltages see page 57

2) Contacts suitable for electronic circuits, according to EN947-5-4 for rated voltage 24V DC (test ratings 17V DC, 5mA) Mirror contacts acc. IEC60947-4-1 Annex F.

3) Technical Data see page 62

## DC Operated

Type	Coil voltage <sup>1)</sup>		Contacts			Pack pcs.	Weight kg/pc.	Wiring Diagrams
			Built-in	Distinc. Number acc. to	Additional Contact Blocks			
	<b>24</b>	24V DC						
	<b>48</b>	48V DC						
	<b>110</b>	110V DC						
	<b>220</b>	220V DC						
	↓		NO	NC	EN50011	Type		



### 3W Coil power, for high switching capacity <sup>3)</sup>

<b>KG3-07A40</b> ...	4	-	40E	max. 4	1	0,53
<b>KG3-07A31</b> ...	3	1	31E	HN..	1	0,53
<b>KG3-07A22</b> ...	2	2	22E	or	1	0,53
<b>KG3-07A04</b> ...	-	4	04E	HA..	1	0,53

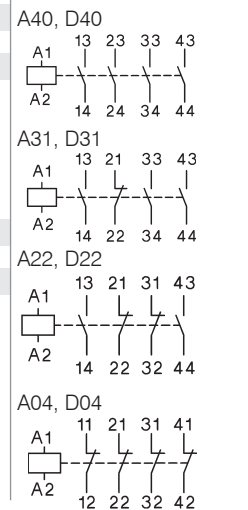

### 3W Coil power, for electronic circuits <sup>2)3)</sup>

<b>KG3-07D40</b> ...	4	-	40E	max. 4	1	0,53
<b>KG3-07D31</b> ...	3	1	31E	HN..	1	0,53
<b>KG3-07D22</b> ...	2	2	22E		1	0,53
<b>KG3-07D04</b> ...	-	4	04E		1	0,53

### with double winding coil, for electronic circuits <sup>2)</sup>

<b>K3-07ND40=</b> ...	4	-	40E	max. 3	1	0,25
<b>K3-07ND31=</b> ...	3	1	31E	HN..	1	0,25
<b>K3-07ND22=</b> ...	2	2	22E	max. 2	1	0,25
<b>K3-07ND04=</b> ...	-	4	04E	HB..	1	0,25

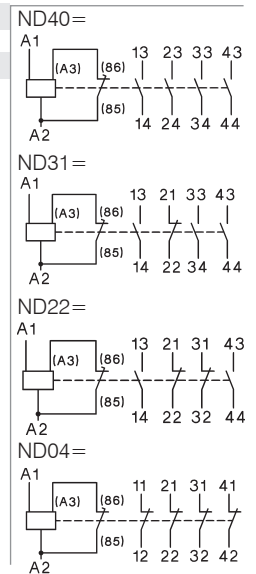

1) Other coil voltages on request  
 2) Contacts suitable for electronic circuits, according to EN947-5-4 for rated voltage 24V DC (test ratings 17V DC, 5mA) Mirror contacts acc. IEC60947-4-1 Annex F.  
 3) with integrated coil suppressor (Transient Voltage Suppressor Diode)

# Contactors Relays

## Data according to IEC 947-5-1, VDE 0660, EN 60947-5-1

			Type	K3-07ND	K3-07ND=	KG3-07A	KG3-07D
<b>Rated insulation voltage <math>U_i</math><sup>1)</sup></b>			V AC	690	690	690	690
<b>Thermal rated current <math>I_{th}</math> to 690V</b>							
Ambient temperature			40°C A	10	10	20	10
			60°C A	6	6	16	6
<b>Frequency of operations z</b>			1/h	10000	10000	10000	10000
<b>Mechanical life</b>			S x 10 <sup>6</sup>	10	10	10	50
<b>Utilization category AC15</b>							
Rated operational current $I_e$			220-240V A	4	4	12	4
			380-415V A	2	2	4	2
			440V A	1,6	1,6	4	1,6
			500V A	1,2	1,2	3	1,2
			660-690V A	0,6	0,6	1	0,6
<b>Utilization category DC13</b>							
Rated operational current $I_e$			24-60V A	3,5	3,5	8	3,5
per pole			110V A	0,5	0,5	1	0,5
			220V A	0,1	0,1	0,1	0,1
<b>Power consumption of coils</b>							
AC operated			inrush VA	30 - 45	-	-	-
			sealed VA	7 - 10	-	-	-
			W	2,6 - 3	-	-	-
DC operated			inrush W	-	75	3	3
			sealed W	-	2	3	3
<b>Operation range of coils</b>							
in multiples of control voltage $U_s$				0,85 - 1,1	0,8 - 1,1	0,8 - 1,1	0,8 - 1,1
<b>Switching time</b> at control voltage $U_s \pm 10\%$							
make time			ms	8 - 16	8 - 16	65 - 85	65 - 85
release time			ms	5 - 13	5 - 13	20 - 30 <sup>3)</sup>	20 - 30 <sup>3)</sup>
<b>Maximum ambient temperature</b>							
Operation			open °C	-40 to +60 (+90) <sup>2)</sup>			
			enclosed °C	-40 to +40			
Storage			°C	-40 to +90			
<b>Short circuit protection</b>							
short-circuit current 1kA, contact welding not accepted max. fuse size			gL (gG) A	20	20	25	20
<b>Cable cross-section</b>							
Connector			solid mm <sup>2</sup>	0,75 - 6			
			flexible mm <sup>2</sup>	1 - 4			
			flexible with multicore cable end mm <sup>2</sup>	0,75 - 4			
Magnet coil			solid mm <sup>2</sup>	0,75 - 2,5			
			flexible mm <sup>2</sup>	0,75 - 2,5			
			flexible with multicore cable end mm <sup>2</sup>	0,5 - 1,5			
Clamps per pole				2			
Connector			solid AWG	18 - 10			
			flexible AWG	18 - 10			
Clamps per pole				2			
Magnet coil			solid AWG	14 - 12			
			flexible AWG	18 - 12			
Clamps per pole				2			

## Data according to UL508

Rated operational current "General Use"			A	10	10	20	10
Rated operational voltage			max. V AC	600	600	600	600
<b>Auxiliary Contacts</b>			heavy pilot duty	A600	A600	A600	A600

1) Suitable at 690V for: earthed-neutral systems, overvoltage category I to IV, pollution degree 3 (standard-industry):  $U_{imp} = 8kV$ .  
Data for other conditions on request.

2) With reduced control voltage range 0,9 up to 1,0 x  $U_s$  and with reduced thermal rated current  $I_{th}$  according to  $I_e/AC15$

3) with built-in coil suppressor

# Contactor Relays

## Position of Terminals

AC operated

**K3-07ND22**

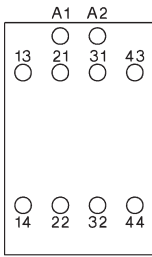

**K3-07ND31**

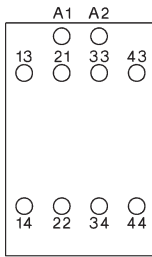

**K3-07ND40**

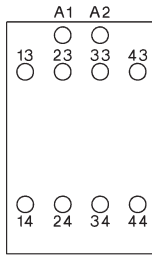

**K3-07ND04**

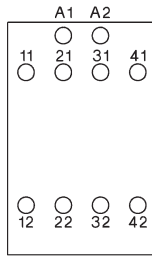

DC operated with double wound coil

**K3-07ND22=**

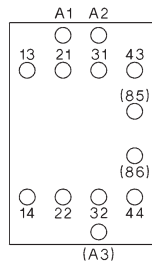

**K3-07ND31=**

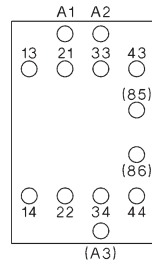

**K3-07ND40=**

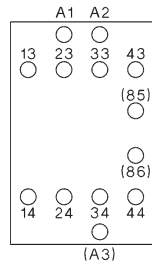

**K3-07ND04=**

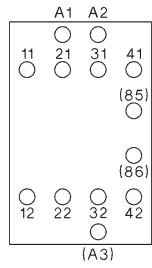

DC solenoid operated

**KG3-07A22**  
**KG3-07D22**

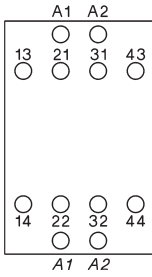

**KG3-07A31**  
**KG3-07D31**

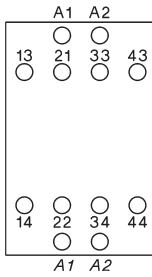

**KG3-07A40**  
**KG3-07D40**

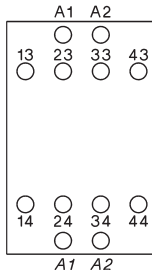

**KG3-07A04**  
**KG3-07D04**

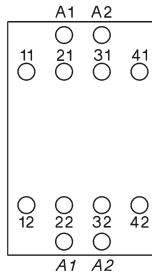

# Contactors Relays

## Dimensions

AC operated

K3-07ND..

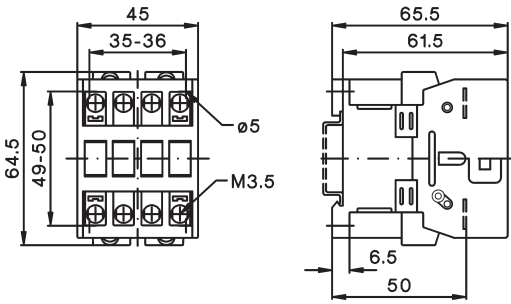

DC solenoid operated

KG3-07..

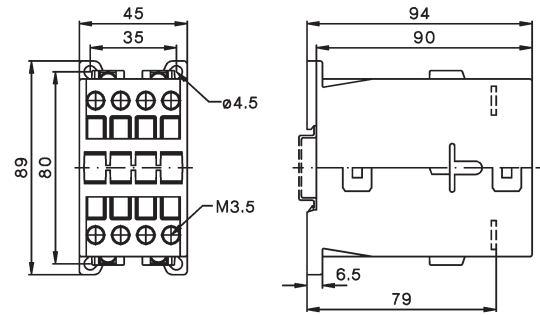

DC operated with double winding coil

K3-07ND.. =

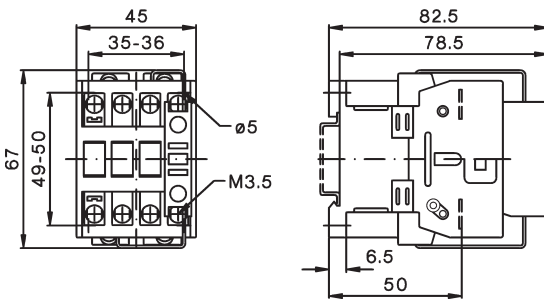





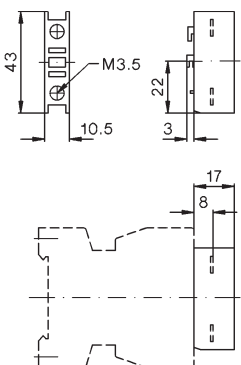



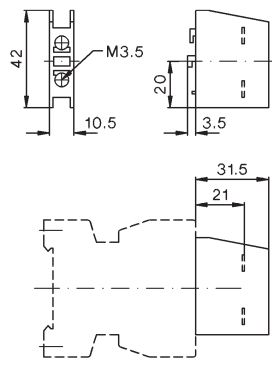





Auxiliary contact blocks

HN10, HN01



HA10, HA01

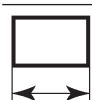

	Contactor overview	46
	Contactors 3-pole, AC Operated	48
	Contactors 3-pole, DC Operated	49
	Contactors 4-pole	50
	Capacitor Switching Contactors	51
	Auxiliary Contact Blocks Snap-on Momentary Contacts Additional Fourth Poles for Contactors	52
	Electronic Timers On-delay	53
	Mechanical Interlocks Mechanical Latches Additional Terminals, Parallel Connectors	54
	Terminal Covers Mounting Parts	55
	Control Voltages	57
	Spare Coils AC-operated Feeder Groups	58
	Spare Coils DC-operated Spare Contacts	60
	Technical Data	62
	Dimensions	82





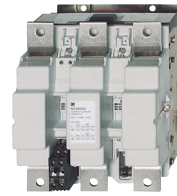

# Contactors 3-pole

- Up to 1200A AC3
- Up to 1350A AC1
- DIN-rail mounting up to AC3 115A
- International Approvals
- Data according to IEC 947 / EN 60947



Ratings		10A	14A	18A	22A	24A	32A	40A	50A	62A	74A	90A	115A
AC3 400V	Motor	4kW	5,5kW	7,5kW	11kW	11kW	15kW	18,5kW	22kW	30kW	37kW	45kW	55kW
	380-400V 660-690V	5,5kW	7,5kW	10kW	10kW	15kW	18,5kW	18,5kW	30kW	37kW	45kW	55kW	55kW
AC1 690V at 40°C		25A	25A	32A	32A	50A	65A	80A	110A	120A	130A	160A	200A
Type	K3-	10ND10	14ND10	18ND10	22ND10	24A00	32A00	40A00	50A00	62A00	74A00	90A00	115A00
Auxiliary contacts		1NO	1NO	1NO	1NO	-	-	-	-	-	-	-	-
Type	K3-	10ND01	14ND01	18ND01	22ND01								
Auxiliary contacts		1NC	1NC	1NC	1NC								
Cable cross-section													
Solid	mm <sup>2</sup>	0,75 - 6				1,5 - 25		4 - 50		10 - 120			
Flexible	mm <sup>2</sup>	1 - 4				2,5 - 16		10 - 35		10 - 95			
Auxiliary contact													
I <sub>th</sub> 40°C	A	10				-		-		-		-	
AC15 230V	A	3				-		-		-		-	
400V	A	2				-		-		-		-	
Power consumption													
Inrush VA		33 - 45				90 - 115		140 - 165		280			
of coils hold VA		7 - 10				9 - 13		13 - 18		5			
Operation range of coils		0,85 - 1,1				0,85 - 1,1		0,85 - 1,1		0,85 - 1,1			
Mounting		35mm DIN-rail or base										2x DIN-rail or base	
Additional aux. contact blocks													
Front mounting	Type	HN10 1NO f. low level switching	HN01 1NC f. low level switching	HA10 1NO 25A I <sub>th</sub>	HA01 1NC 25A I <sub>th</sub>	max. 4 HN.. or 4 HA..		max. 7 HN.. or 7 HA..					
Side mounting	Type	HB11-1 1NO+1NC f. low level switching	max. 2 HB..	HB11 1NO+1NC f. low level switching	HB02 2NC f. low level switching	max. 2 HB..							
Overload Relay (thermal)													
Single phase protection													
Temperature compensation													
Trip and alarm contacts													
Type		U3/32		U3/42		U3/74		U85					
Number of Setting Ranges from		16 0,12 - 30A		16 0,12 - 32A		4 10 - 42A		5 20 - 74A		2 60 - 120A			
Busbar sets		-		-		-		-		-			



<b>150A</b>	<b>175A</b>	<b>210A</b>	<b>260A</b>	<b>315A</b>	<b>450A</b>	<b>550A</b>	<b>700A</b>	<b>860A</b>	<b>1000A</b>	<b>1200A</b>
<b>75kW</b> 90kW	<b>90kW</b> 110kW	<b>110kW</b> 160kW	<b>132kW</b> 210kW	<b>160kW</b> 250kW	<b>250kW</b> 375kW	<b>300kW</b> 475kW	<b>400kW</b> 630kW	<b>500kW</b> 700kW	<b>580kW</b> 850kW	<b>680kW</b> 1000kW
250A	300A	350A	450A	600A	700A	800A	1000A	1100A	1200A	1350A
<b>151A00</b>	<b>176A00</b>	<b>210A00</b>	<b>260A00</b>	<b>316A00</b>	<b>450A22</b>	<b>550A22</b>	<b>700A22</b>	<b>860A22</b>	<b>1000A12</b>	<b>1200A12</b>
-	-	-	-	-	2NO+2NC	2NO+2NC	2NO+2NC	2NO+2NC	1NO+2NC	1NO+2NC
2 x 16-120 2 x 16-120		busbar 30x6	busbar 30x6	busbar 30x6	busbar 30x5	busbar 40x6	busbar 50x8	busbar 50x8	busbar 50x10	busbar 50x10
- - -		-	-	-		10 3 2			10 3 2	
350 5 0,85 - 1,1	350 5	360 5	360 5 0,85 - 1,1	360 5	800-950 9-11	800-950 9-11	1350-1600 21-25 0,85 - 1,1	1350-1600 21-25	2400 70 0,85-1,1	2400 70
base										
	<b>HKT11 HKT22</b> 1NO+1NC 2NO+2NC max. 1 pc.					<b>HKF22</b> 2NO+2NC max. 1 pc.				<b>HKB11</b> 1NO+1NC max. 2 pcs.
	<b>HKA11</b> 1NO+1NC max. 2 pcs.				-	-	-	-	-	-
										
<b>U180</b>	<b>U320</b>				<b>U800</b>					
1 120 - 180A integrated	2 144 - 320A integrated				3 240 - 800A SU840/550   SU840/860					

Contactor, Motor-Starter

Circuit Breakers

Manual Motor-Starters

Switches

AC-Main Switches



DC-Switch Disconnect

Push Buttons

Representatives, Suppliers

# Contactors 3-pole

# AC Operated

Ratings		Rated Current	Aux. Contacts		Type	Coil voltage <sup>1)</sup>	Pack pcs.	Weight kg/pc.
AC2, AC3			Built-in	Additional see page 53				
380V								
400V	660V	AC1				24V 50/60Hz		
415V	690V	690V				110V 50/60Hz		
kW	kW	A	NO	NC	Typ	220-240V 50Hz		
						380-415V 50Hz		
						↓		
<b>4</b>	5,5	25	1	-	max. 4		1	0,23
<b>4</b>	5,5	25	-	1	HN.. or HA..		1	0,23
<b>5,5</b>	7,5	25	1	-	and 2 HB..		1	0,23
<b>5,5</b>	7,5	25	-	1			1	0,23
<b>7,5</b>	10	32	1	-			1	0,23
<b>7,5</b>	10	32	-	1			1	0,23
<b>11</b>	10	32	1	-			1	0,23
<b>11</b>	10	32	-	1			1	0,23
<b>11</b>	15	50	-	-	max. 4		1	0,48
<b>15</b>	18,5	65	-	-	HN.. or HA..		1	0,48
<b>18,5</b>	18,5	80	-	-	and 2 HB..		1	0,48
<b>22</b>	30	110	-	-	max. 4 (3) <sup>4)</sup>		1	0,85
<b>30</b>	37	120	-	-	HN.. or HA..		1	0,85
<b>37</b>	45	130	-	-	and 2 HB..		1	0,85
<b>45</b>	55	160	-	-	max. 7		1	2,2
<b>55</b>	55	200	-	-	HN.. or HA.. and 2 HB..		1	2,2
<b>75</b>	110	250	-	-	1 HKT..		1	4
<b>90</b>	132	300	-	-	and 2 HKA11		1	4
<b>110</b>	160	350	-	-			1	7,2
<b>132</b>	210	450	-	-			1	7,2
<b>160</b>	250	600	-	-			1	7,2
<b>250</b>	375	700	2	2	1 HKF22		1	13
<b>300</b>	475	800	2	2			1	13,5
<b>400</b>	630	1000	2	2			1	26,5
<b>500</b>	700	1100	2	2			1	27,6
<b>580</b>	850	1200	1	2	2 HKB11		1	49
<b>680</b>	1000	1350	1	2			1	53

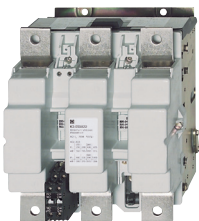

1) Coil voltage range and other coil voltages see page 57.

2) Type for AC- and DC-operating: e.g.: 230: 220-240V 50/60Hz and 220V DC (with integrated coil suppressor).

3) Type 230VS for AC-operating 220-240V 50Hz (with integrated coil suppressor).

4) max. 3 HN.. or HA.. for DC-operated Contactors..

# DC Operated

## Type

Coil voltage <sup>1)</sup>  
**24** 24V DC  
**48** 48V DC  
**110** 110V DC  
**220** 220V DC

Coil power

inrush/  
hold

Additional  
Overload  
Relay  
see  
page 114

W/W

Type

Pack  
pcs.

Weight  
kg/pc.

Wiring Diagram

Coil Circuits  
see page 59

Terminal Markings



<b>KG3-10D10</b> ... <sup>5)</sup>	3/3	U3/32	1	0,53
<b>KG3-10D01</b> ... <sup>5)</sup>	3/3	U12/16E U12/16EQ	1	0,53
<b>KG3-14D10</b> ... <sup>5)</sup>	3/3	UAT21	1	0,53
<b>KG3-14D01</b> ... <sup>5)</sup>	3/3		1	0,53
<b>KG3-18D10</b> ... <sup>5)</sup>	3/3		1	0,53
<b>KG3-18D01</b> ... <sup>5)</sup>	3/3		1	0,53
<b>KG3-22D10</b> ... <sup>5)</sup>	3/3		1	0,53
<b>KG3-22D01</b> ... <sup>5)</sup>	3/3		1	0,53

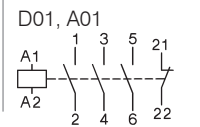
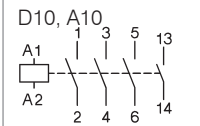

<b>KG3-24A00</b> ... <sup>5)</sup>	4/4	U3/32	1	0,57
<b>KG3-32A00</b> ... <sup>5)</sup>	4/4	U3/42	1	0,57
<b>KG3-40A00</b> ... <sup>5)</sup>	4/4	UAT..	1	0,57

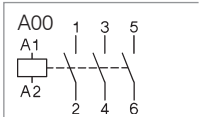

<b>K3-50A00=</b> ...	200/6	U3/74	1	0,9
<b>K3-62A00=</b> ...	200/6		1	0,9
<b>K3-74A00=</b> ...	200/6		1	0,9

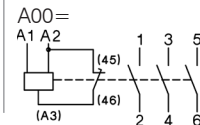

<b>K3-90A00</b> ... <sup>2)</sup>	280/5	U85	1	2,2
<b>K3-115A00</b> ... <sup>2)</sup>	280/5		1	2,3

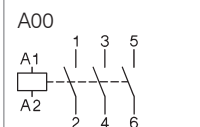

<b>K3-151A00</b> ... <sup>2)</sup>	350/5	U180	1	4
<b>K3-176A00</b> ... <sup>2)</sup>	350/5		1	4



<b>K3-210A00</b> ... <sup>2)</sup>	360/5	U320	1	7,2
<b>K3-260A00</b> ... <sup>2)</sup>	360/5		1	7,2
<b>K3-316A00</b> ... <sup>2)</sup>	360/5		1	7,2

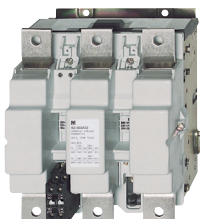

<b>K3-450A22</b> ... <sup>2)</sup>	800/10	U800	1	13
<b>K3-550A22</b> ... <sup>2)</sup>	800/10	+SU840/550	1	13,5

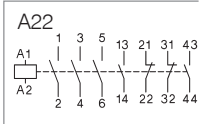

<b>K3-700A22</b> ... <sup>2)</sup>	1500/20	U800	1	26,5
<b>K3-860A22</b> ... <sup>2)</sup>	1500/20	+SU840/860	1	27,6

<b>K3-1000A12=</b> ...	2100/60		1	49
<b>K3-1200A12=</b> ...	2100/60		1	53

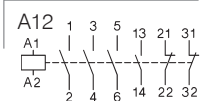

1) Other coil voltages on request.

2) Type for AC- and DC-operating: e.g.: 24: 24V 50/60Hz and 24V DC (with integrated coil suppressor).

5) With integrated coil suppressor.

# Contactors 3-pole

DC operated with dual-wound coil



Ratings	Rated Current	Aux. Contacts Built-in	Additional see page 53	Type	Coil voltage <sup>1)</sup>		Pack pcs.	Weight kg/pc.
					24V= DC	48V= DC		
AC2					24	48		
AC3					110	220		
<b>380V</b>	AC1							
<b>400V</b>	660V							
<b>415V</b>	690V	690V						
<b>kW</b>	kW	A	NO NC Type					
<b>4</b>	5,5	25	1 -	max. 3	<b>K3-10ND10=</b> ...		1	0,25
<b>4</b>	5,5	25	- 1	HN.. or HA..	<b>K3-10ND01=</b> ...		1	0,25
<b>5,5</b>	7,5	25	1 -	and 2 HB..	<b>K3-14ND10=</b> ...		1	0,25
<b>5,5</b>	7,5	25	- 1		<b>K3-14ND01=</b> ...		1	0,25
<b>7,5</b>	10	32	1 -		<b>K3-18ND10=</b> ...		1	0,25
<b>7,5</b>	10	32	- 1		<b>K3-18ND01=</b> ...		1	0,25
<b>11</b>	10	32	1 -		<b>K3-22ND10=</b> ...		1	0,25
<b>11</b>	10	32	- 1		<b>K3-22ND01=</b> ...		1	0,25
<b>11</b>	15	50	- -	max. 3	<b>K3-24A00=</b> ...		1	0,55
<b>15</b>	18,5	65	- -	HN.. or HA..	<b>K3-32A00=</b> ...		1	0,55
<b>18,5</b>	18,5	80	- -	and 2 HB..	<b>K3-40A00=</b> ...		1	0,55

Wiring Diagram

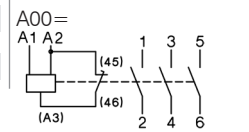
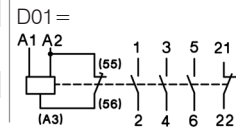
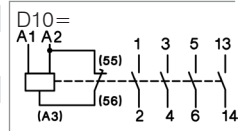

1) Other coil voltages on request.

# Capacitor Switching Contactors

for use with reactive or non-reactive capacitor banks



Rated Operational Power at 50/60Hz Ambient Temperature						Aux. Contacts Built-in Add.		Type	Coil voltage <sup>1)</sup>	Pack	Weight
50°C			60°C			NO	NC		220-240V 50Hz	pcs.	kg/pc.
380V	415V	660V	380V	415V	660V	↓	↓		230		
400V	440V	690V	400V	440V	690V						
kVAr	kVAr	kVAr	kVAr	kVAr	kVAr						
0-12,5	0-13	0-20	0-12,5	0-13	0-20	1	-	1 <sup>2)</sup>	<b>K3-18NK10 ...</b>	1	0,34
0-12,5	0-13	0-20	0-12,5	0-13	0-20	-	-	1 <sup>2)</sup>	<b>K3-18NK01 ...</b>	1	0,34
0-12,5	0-13	0-20	0-12,5	0-13	0-20	1	-	1 <sup>2)</sup>	<b>K3-18NBK10 ...</b>	1	0,40
10-20	10,5-22	17-33	10-20	10,5-22	17-33	-	-	3 <sup>3)</sup>	<b>K3-24K00 ...</b>	1	0,62
10-25	10,5-27	17-41	10-25	10,5-27	17-41	-	-	3 <sup>3)</sup>	<b>K3-32K00 ...</b>	1	0,62
20-33,3	23-36	36-55	20-33,3	23-36	36-55	-	-	3 <sup>3)</sup>	<b>K3-50K00 ...</b>	1	1,0
20-50	23-53	36-82	20-50	23-53	36-82	-	-	3 <sup>3)</sup>	<b>K3-62K00 ...</b>	1	1,0
20-75 <sup>4)</sup>	23-75 <sup>4)</sup>	36-120 <sup>4)</sup>	20-60	23-64	36-100	-	-	3 <sup>3)</sup>	<b>K3-74K00 ...</b>	1	1,0
33-80	36-82	57-120	33-75	36-77	57-120	-	-	6 <sup>5)</sup>	<b>K3-90K00 ... / VS<sup>7)</sup></b>	1	2,3
33-100 <sup>6)</sup>	36-103 <sup>6)</sup>	57-148 <sup>6)</sup>	33-90 <sup>6)</sup>	36-93 <sup>6)</sup>	57-148 <sup>6)</sup>	-	-	6 <sup>5)</sup>	<b>K3-115K00 ... / VS<sup>7)</sup></b>	1	2,3

**Specification:** Contactors K3-..K are suitable for switching low-inductive and low loss capacitors in capacitor banks (IEC70 and 831, VDE 0560) without and with reactors.

Capacitor switching contactors are fitted with early make contacts and damping resistors, to reduce the value of make current <70 x I<sub>e</sub>.

**Operating Conditions:** Capacitor switching contactors are protected against contact welding for a prospective making current of 200 x I<sub>e</sub>.

**Technical Data** acc. to IEC 947-4-1, IEC 947-5-1, EN 60947-4-1, EN 60947-5-1, VDE 0660 (further details page 64)

Type		K3-18NK	K3-18NBK <sup>8)</sup>	K3-24K	K3-32K	K3-50K	K3-62K	K3-74K	K3-90K	K3-115K
Max. frequency of operations z	1/h	120	120	120	120	120	120	80	80	80
<b>contact life</b>	K3-..K non reactive banks Sx10 <sup>3</sup>	250	250	150	150	150	150	120	120	120
	K3-..K/BK/D/A <sup>9)</sup> reactive banks Sx10 <sup>3</sup>	400	400	300	300	300	300	200	200	200
<b>Rated operational current AC6b</b>	I <sub>e</sub> at 50°C A	<b>0-18</b>	<b>0-18</b>	<b>14-28</b>	<b>14-36</b>	<b>30-48</b>	<b>30-72</b>	<b>30-108</b>	<b>50-115</b>	<b>50-144</b>
	at 60°C A	<b>0-18</b>	<b>0-18</b>	<b>14-28</b>	<b>14-36</b>	<b>30-48</b>	<b>30-72</b>	<b>30-87</b>	<b>50-108</b>	<b>50-130</b>
Rated operational current AC1	I <sub>th</sub> at 50°C A	32	45	45	60	100	110	120	155	190
	at 60°C A	32	40	40	55	90	100	110	145	170
Overload factor acc. to EN 61921: 30% min.	at 50°C %	78	150	60	67	108	53	11	35	32
	at 60°C %	78	122	43	53	88	39	26	34	31
Fuses gL (gG)	from / to A	35 / 63	35 / 63	50 / 80	63 / 100	80 / 160	125 / 160	160/200	160/200	160/250

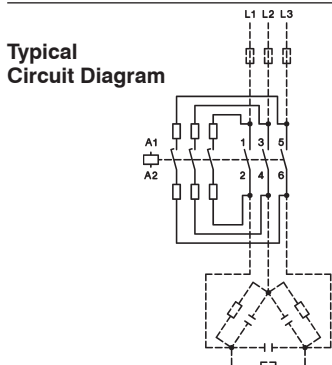

### Wiring Diagram for Quick Discharge Resistors

Make sure that the current of the discharge resistors is not higher than the rated current (AC1) of the auxiliary contacts.

### Mounting instructions:

In the area of capacitor switching contactors, difficulty inflammable and self-extinguishing materials shall be used only, because abnormal temperatures within the area of the resistor spirals cannot be excluded.

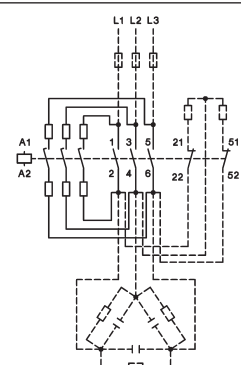

- 1) Coil voltage range and non-standard coil voltages see page 57.
- 2) 1 HN.. or HA.. snap-on.
- 3) 2HB.. for side mounting and 1 HN.. or HA.. snap-on.
- 4) Consider the max. thermal current of the contactor K3-74A: I<sub>th</sub> 130A.
- 5) 2 HB.. on the left or right side and 4 HN.. or HA.. snap-on.
- 6) Consider the min. cross-section of conductor at max. load.
- 7) Type 230 for AC- and DC-operating 220-240V 50/60Hz and 220V DC (with integrated coil suppressor). Type 230VS for AC-operating 220-240V 50Hz (with integrated coil suppressor).
- 8) Cable cross sections: 2,5 - 16mm<sup>2</sup>.
- 9) K3-..K.. / K3-..BK.. / K3-..D.. / K3-..A..

# Contactors 4-pole

AC or DC operated

Rated Current	Ratings			Aux. Contacts Additional see page 53	Type	Coil voltage <sup>2)</sup>	Pack pcs.	Weight kg/pc.	Wiring Diagram
	AC1	AC2	AC3						
<b>AC1</b>		380V	400V			24V 50/60Hz			
<b>max. 690V</b>		400V	415V			110V 50/60Hz			
<b>A</b>		kW	kW			220-240V 50Hz			
<b>NO</b>	<b>NC</b>	<b>NO</b>	<b>NC</b>			380-415V 50Hz			
						24V= DC <sup>3)</sup>			
<b>25</b>	-	17,5	-	4	max. 4 <sup>3)</sup>	<b>K3-10NA00-40</b> .. <sup>3)</sup>	1	0,23	
<b>25</b>	<b>25</b>	17,5 <sup>6)</sup>	17,5 <sup>6)</sup>	4 <sup>6)</sup>	HN.. or	<b>K3-10NA00-22</b> .. <sup>3)</sup>	1	0,23	
-	<b>25</b>	-	17,5	4	HA.. and 2 HB..	<b>K3-10NA00-04</b> .. <sup>3)</sup>	1	0,23	
<b>25</b>	-	17,5	-	5,5		<b>K3-14NA00-40</b> .. <sup>3)</sup>	1	0,23	
<b>25</b>	<b>25</b>	17,5 <sup>6)</sup>	17,5 <sup>6)</sup>	5,5 <sup>6)</sup>		<b>K3-14NA00-22</b> .. <sup>3)</sup>	1	0,23	
-	<b>25</b>	-	17,5	5,5		<b>K3-14NA00-04</b> .. <sup>3)</sup>	1	0,23	
<b>32</b>	-	22	-	7,5		<b>K3-18NA00-40</b> .. <sup>3)</sup>	1	0,23	
<b>32</b>	<b>32</b>	22 <sup>6)</sup>	22 <sup>6)</sup>	7,5 <sup>6)</sup>		<b>K3-18NA00-22</b> .. <sup>3)</sup>	1	0,23	
-	<b>32</b>	-	22	7,5		<b>K3-18NA00-04</b> .. <sup>3)</sup>	1	0,23	
<b>32</b>	-	22	-	11		<b>K3-22NA00-40</b> .. <sup>3)</sup>	1	0,23	
<b>50</b>	-	34,5	-	11	max. 4 <sup>3)</sup>	<b>K3-24A00-40</b> .. <sup>3)</sup>	1	0,65	
<b>50</b>		34,5	27,5	11	HN.. or	<b>K3-24A00-22</b> .. <sup>3)</sup>	1	0,65	
-	<b>40</b>	-	27,5	11	HA.. and 2 HB..	<b>K3-24A00-04</b> .. <sup>3)</sup>	1	0,65	
<b>65</b>	-	45	-	15		<b>K3-32A00-40</b> .. <sup>3)</sup>	1	0,65	
<b>65</b>	<b>50</b>	45	34,5	15		<b>K3-32A00-22</b> .. <sup>3)</sup>	1	0,65	
-	<b>50</b>	-	34,5	15		<b>K3-32A00-04</b> .. <sup>3)</sup>	1	0,65	
<b>80</b>	-	55,4	-	18,5		<b>K3-40A00-40</b> .. <sup>3)</sup>	1	0,65	
<b>80</b>	<b>65</b>	55,4	45	18,5		<b>K3-40A00-22</b> .. <sup>3)</sup>	1	0,65	
-	<b>65</b>	-	45	18,5		<b>K3-40A00-04</b> .. <sup>3)</sup>	1	0,65	
<b>110</b>	-	62	-	22	max. 6 <sup>5)</sup>	<b>K3-50A00-40</b> .. <sup>5)</sup>	1	1,1	
<b>120</b>	-	69	-	30	HN.. or	<b>K3-62A00-40</b> .. <sup>5)</sup>	1	1,1	
<b>130</b>	-	78	-	37	HA.. and 2 HB..	<b>K3-74A00-40</b> .. <sup>5)</sup>	1	1,1	
<b>135</b>	-	94	-	45	1 HKT..	<b>K3-96A00-40</b> .. <sup>4)</sup>	1	2,42	
<b>125</b>	<b>125</b>	85 <sup>6)</sup>	85 <sup>6)</sup>	30	+	<b>K3-96A00-22</b> .. <sup>4)</sup>	1	2,42	
-	<b>125</b>	-	85	30	2 HKA11	<b>K3-96A00-04</b> .. <sup>4)</sup>	1	2,42	
<b>200</b>	-	139	-	55		<b>K3-116A00-40</b> .. <sup>4)</sup>	1	4,7	
<b>250</b>	-	173	-	75		<b>K3-151A00-40</b> .. <sup>4)</sup>	1	4,7	
<b>300</b>	-	208	-	90		<b>K3-176A00-40</b> .. <sup>4)</sup>	1	4,7	
<b>350</b>	-	242	-	110		<b>K3-210A00-40</b> .. <sup>4)</sup>	1	8	
<b>450</b>	-	310	-	132		<b>K3-260A00-40</b> .. <sup>4)</sup>	1	8	
<b>600</b>	-	415	-	160		<b>K3-316A00-40</b> .. <sup>4)</sup>	1	8	



## Terminal Blocks for contactors K(G)3-07.. to K3-115.. and K2-..



Specification	Thermal Current I <sub>th</sub> A	Type	Pack pcs.	Weight kg/pc.
2 terminals interconnected	26	<b>K2-DK</b>	10	0,02
2 terminals insulated	26	<b>K2-SK</b>	10	0,02

1) Other coil voltages on request.  
 2) Coil voltage range and non-standard coil voltages see page 57.  
 3) DC operated with dual-wound coil, max. 3 additional aux. contacts.

4) With integrated coil suppressor (AC/DC coil).  
 5) DC operated with dual-wound coil, max. 5 additional aux. contacts.  
 6) Ratings for 3 poles in use.

**Auxiliary Contact Blocks** for contactors K(G)3-07.. to K3-115.., type HN.. for low level switching <sup>1)</sup>



Rated Operational Current			Contacts				Type	Pack pcs.	Weight kg/pc.
AC15 230V A	AC15 400V A	AC1 690V A	NO	NC	EM	LB			
3	2	10	1	-	-	-	<b>HN10</b>	10	0,02
3	2	10	-	1	-	-	<b>HN01</b>	10	0,02
3	2	10	-	-	1	-	<b>HN10U</b>	10	0,02
3	2	10	-	-	-	1	<b>HN01U</b>	10	0,02
6	3	25	1	-	-	-	<b>HA10</b>	10	0,03
6	3	25	-	1	-	-	<b>HA01</b>	10	0,03

**Auxiliary Contact Blocks** for contactors K3-.., for low level switching <sup>1) 3)</sup>



Rated Operational Current				Contacts		Type	Pack pcs.	Weight kg/pc.
AC15 230V A	AC15 400V A	AC1 690V A	mounting: 1 HB.. on left side and 1 HB.. on right side	NO	NC			
3	2	10	for K3-10 to K3-22	1	1	<b>HB11-1</b>	10	0,02
3	2	10	for K3-24 to K3-115	1	1	<b>HB11</b>	10	0,02
3	2	10	for K3-24 to K3-115	-	2	<b>HB02</b>	10	0,02

**Auxiliary Contact Blocks** for contactors K3-41.., K3-96.., K3-116.. to K3-1200.., for low level switching <sup>1)</sup>



Rated Operational Current				Contacts		Type	Pack pcs.	Weight kg/pc.
AC15 230V A	AC15 400V A	AC1 690V A	For contactors	NO	NC			
3	2	10	K3-116 to K3-316 top	1	1	<b>HKT11</b>	1	0,04
3	2	10	K3-116 to K3-316 top	2	2	<b>HKT22</b>	1	0,05
3	2	10	K3-116 to K3-316 outside	1	1	<b>HKA11</b>	1	0,05
6	3	16	K3-450 to K3-860 <sup>2)</sup>	2 <sup>2)</sup>	2	<b>HKF22</b>	1	0,12
6	3	16	K3-1000, K3-1200 inside	1	1	<b>HKB11</b>	1	0,17

**Snap-on Momentary Contacts** for K(G)3-07.. to K3-115.. for low level switching <sup>1)</sup>



Rated Operational Current				Contacts		Type	Pack pcs.	Weight kg/pc.
AC15 230V A	AC15 400V A	AC1 690V A	Specification	NO	NC			
3	2	10	manual operated	1	-	<b>HTN10</b>	10	0,02
3	2	10	manual operated	-	1	<b>HTN01</b>	10	0,02

**Electronic Timer**

for mounting on DIN-rail, Control voltage 24-240V AC/DC, 1 changeover contact  
OFF-delay without auxiliary voltage  
Replace Pneumatic Timer K2-TP.. and K2-TA



5 Functions in one device	4 Time ranges in one device s	Rated Current AC1 250V A	Type	Pack pcs.	Weight kg/pc.
ON-delay, OFF-delay, Single shot trailing edge, Single shot leading edge, Single shot leading and trailing edge	0,1 - 1,0 1,0 - 10 6 - 60 18 - 180	5	<b>K3-T180 240</b>	1	0,085

1) Contacts suitable for electronic circuits, according to IEC60947-5-4 for rated voltage 24V DC.  
(test ratings 17V DC, 5mA) Mirror contacts acc. IEC60947-4-1 Annex F.  
Technical data see page 80.  
2) Contact travel of make contacts adjustable, see page 81.  
3) Except K3-96A00..

## Electronic Timer On-delay for contactors K(G)3-07.. to K3-115..<sup>1)</sup>

Timer will be connected with the contactor coil, can be snapped onto the contactor and occupies 2 add-on spaces. Contactor switches On-delay.



Operational Voltage V	Time Range s	Rated Current AC15 A	Type	Pack pcs.	Weight kg/pc.
24 - 60V AC/DC	1 - 30	0,75	<b>K2-TE30 60</b>	1	0,08
100 - 250V AC/DC	1 - 30	0,75	<b>K2-TE30 250</b>	1	0,08
24 - 60V AC/DC	10 - 180	0,75	<b>K2-TE180 60</b>	1	0,08
100 - 250V AC/DC	10 - 180	0,75	<b>K2-TE180 250</b>	1	0,08

### Wiring Diagram

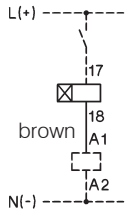

### Timing Chart

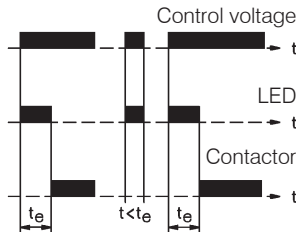

### Operation Range

Time repeat accuracy  
Recovery time (typical)

$0,8 - 1,1 \times U_s$   
 $\leq 1\%$   
50ms

**Voltage Drop** after the time delay  $t_e$   
(Control voltage 24V: use contactor with 20V-coil)  
Max. inrush current (peak value)

<3V  
25A <10ms

### Duty Cycle

Ambient temperature  
Short circuit protection

100%  
-40° - +60°C  
2A

## Latch for contactors K(G)3-07.. to K3-74.. and K2-..

with NC aux. contact  
duty cycle 10%, max. 30 sec. AC / max. 20 sec. DC  
power consumption max. 35VA

**Type**  
**24** Coil voltage 22-26V 50/60Hz  
**110** 100-120V 50/60Hz  
**230** 210 -250V 50/60Hz  
**400** 360-440V 50/60Hz

For Contactors

For Contactors	Type	Pack pcs.	Weight kg/pc.
K3-07 to K3-22, K2-07 to K2-16	<b>K2-L22 . . .</b>	1	0,08
K3-24 to K3-40, K2-23 to K2-37, KG3-10 to KG3-40	<b>K2-L40 . . .</b>	1	0,08
K3-50 to K3-74, K2-45 to K2-60	<b>K2-L74 . . .</b>	1	0,08

**Mechanical / Magnetic latch for Contactors K3-151 to K3-1200 on request**



## Snap-On Adapter

For Type	Specification	Type	Pack pcs.	Weight kg/pc.
----------	---------------	------	-----------	---------------



K2-DK, K2-SK, K2-TE, K2-TA K2-F, K2-RF K2-IN., K2-UN.	for snap-on mounting of accessories on 35mm DIN-rail acc. DIN EN 50022	<b>K2-SM</b>	10	0,009
---	--	--------------	----	-------

1) Do not fit on K3-24A00-40, K3-32A00-40 and K3-40A00-40 (4 pole contactors).

## Additional 4<sup>th</sup> Poles for contactors K3-450.. to K3-1200



For Contactors	Thermal Current $I_{th}$ A	Type	Pack pcs.	Weight kg/pc.
K3-450, K3-550	<b>800</b>	<b>NP800</b>	1	1,4
K3-700, K3-860	<b>1000</b>	<b>NP1000</b>	1	1,6
K3-1000, K3-1200	<b>1000</b>	<b>NP1001</b>	1	1,6

## Mechanical Interlocks



Interlocks contactor with contactor Type	Type	Mounting	Type	Pack pcs.	Weight kg/pc.
K3-07 to K3-40 KG3-07 to KG3-22 KG3-24 to KG3-40 K2-07 to K2-37	K3-07 to K3-40 KG3-07 to KG3-22 KG3-24 to KG3-40 K2-07 to K2-37	horizontal	<b>LG10889</b> <sup>1)</sup>	10	0,006
K3-24 to K3-74 K2-23 to K2-60	K3-50 to K3-74 K2-45 to K2-60	horizontal	<b>LG10890</b> <sup>1)</sup>	1	0,010
K3-90, K3-115	K3-90, K3-115	horizontal	<b>LG11478</b> <sup>1)</sup>	1	0,010
K65 to K110	K65 to K110	horizontal	<b>LG8511</b>	1	0,076
K3-116 to K3-316	K3-116 to K3-316	horizontal	<b>LG11223H</b>	1	0,06
K3-315 to K3-550	K3-315 to K3-550	horizontal	<b>LG10400H</b>	1	0,8
K3-315 to K3-550	K3-315 to K3-550	vertical	<b>LG10400V</b>	1	0,8
K3-450, K3-550	K3-700, K3-860	horizontal	<b>LG10399H</b>	1	1,6
K3-450, K3-550	K3-700, K3-860	vertical	<b>LG10399V</b>	1	0,9
K3-700, K3-860	K3-700, K3-860	horizontal	<b>LG10402H</b>	1	1,5
K3-700, K3-860	K3-700, K3-860	vertical	<b>LG10402V</b>	1	0,9
K3-700, K3-860	K3-1000, K3-1200	horizontal	<b>LG10401H</b>	1	1,9
K3-700, K3-860	K3-1000, K3-1200	vertical	<b>LG10401V</b>	1	1,6
K3-1000, K3-1200	K3-1000, K3-1200	horizontal	<b>LG10403H</b>	1	1,8
K3-1000, K3-1200	K3-1000, K3-1200	vertical	<b>LG10403V</b>	1	1,5

1) clamps for mounting incl.

## Terminal Covers for terminal protection according to DIN 57106, VBG 4



For Contactors	Specification	Type	Pack pcs.	Weight kg/pc.
K65 to K110 (spare part)	for 6 terminals	<b>LG9333</b>	1	0,045
K3-151, K3-176	3-pole for 3 terminals	<b>LG10404</b>	1	0,12
K3-116 to K3-176	4-pole for 4 terminals	<b>LG104044</b>	1	0,14
K3-210, K3-260, K3-316	for 3 terminals	<b>LG11457</b>	1	0,14
K3-200	for 3 terminals	<b>LG10405</b>	1	0,18
K3-315, K3-450	for 3 terminals	<b>LG10406</b>	1	0,28
K3-550	for 3 terminals	<b>LG10407</b>	1	0,34
K3-700	for 3 terminals	<b>LG10408</b>	1	0,39
K3-860	for 3 terminals	<b>LG10409</b>	1	0,49

## Additional Terminals



For Contactors	Cable Cross-sections to clamp mm <sup>2</sup> solid or stranded	flexible	flex. with multi- core cable end	Type	Pack pcs.	Weight kg/pc.
<b>Additional Terminal Single Pole, with fingertouch protection</b>						
K(G)3-10 to K(G)3-22	0,75 - 10	0,75 - 6	0,75 - 6	<b>LG9339N</b>	6	0,009
K2-09 to K2-16						
K3-116 to K3-176		16 - 120	+ 16 - 95	<b>LG11224</b>	1	0,10

1) Inclusively mounting clamps

## Parallel Connectors

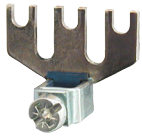

For Contactors	Cable Cross-sections to clamp	Type	Pack pcs.	Weight kg/pc.
	solid or stranded	flexible		
		flex. with multi-core cable end		

### Parallel Connectors, 3 Poles Parallel

Current-carrying capacity: 2,5 x AC1-value of the contactor

Description	Specification	Type	Pack pcs.	Weight kg/pc.
K(G)3-10 to K(G)3-22	terminal hole for screw M5	<b>LG9241</b>	50	0,004
K2-09 to K2-16				
K2-23 to K2-37	4 - 35      6 - 25      4 - 25	<b>LG5587</b>	10	0,022

### Parallel Connectors, 4 Poles Parallel

Current-carrying capacity: 3,2 x AC1-value of the contactor

Description	Specification	Type	Pack pcs.	Weight kg/pc.
K(G)3-10 to K(G)3-22	terminal hole for screw M5	<b>LG7360</b>	10	0,006
K2-09 to K2-16				

## Suppressor Units



Voltage Range V	Mounting	Type	Pack pcs.	Weight kg/pc.
-----------------	----------	------	-----------	---------------

**RC-units** for contactors K3-07 - K3-74 and all types of contactor combinations

12 - 48V AC/DC	to snap	1600nF / 22 Ohm	<b>RC-K3 24</b>	10	0,01
48 - 127V AC/DC	on the	680nF / 270 Ohm	<b>RC-K3 110</b>	10	0,01
110 - 250V AC/DC	contactor	220nF / 2200 Ohm	<b>RC-K3 230</b>	10	0,01
250 - 415V AC/DC		120nF / 620 Ohm	<b>RC-K3 400</b>	10	0,01

## Mounting Parts



Description	For Type	Specification	Type	Pack pcs.	Weight kg/pc.
-------------	----------	---------------	------	-----------	---------------

<b>Clamp, no distance</b>	K3-07 to K3-115 K2-07 to K2-37	To join contactors without distance, 2 pieces required	<b>P426-1</b>	50	0,001
---------------------------	-----------------------------------	--	---------------	----	-------



<b>Clamp, 7mm distance</b>	K3-07 to K3-115 K2-07 to K2-37	To join contactors with 7mm distance, 2 pieces required	<b>P418-1</b>	10	0,002
----------------------------	-----------------------------------	---	---------------	----	-------

<b>Clamp, 12mm distance</b>	K3-07 to K3-115 K2-07 to K2-37	To join contactors with 12mm distance, 2 pieces required	<b>P807-1</b>	10	0,002
-----------------------------	-----------------------------------	--	---------------	----	-------

<b>Clamp asymmetric</b>	K3-07 to K3-40 with K3-50 to K3-74	To join contactors with 12mm distance, 2 pieces required	<b>P785-1</b>	10	0,002
-------------------------	---------------------------------------	--	---------------	----	-------



<b>Retention clamp</b>	K3-10 to K3-74	To close contactors	<b>P725</b>		
------------------------	----------------	---------------------	-------------	--	--

## Marking System for contactors K3-07.. to K3-115.., K2-.. and aux. contact blocks HN and HA



Description	Specification	Type	Pack pcs.	Weight kg/100pc
-------------	---------------	------	-----------	-----------------

<b>Marking Plate</b>	2-section without marking, divisible	<b>P487-1</b>	100	0,025
----------------------	--------------------------------------	---------------	-----	-------

<b>Marking Plate</b>	3-section without marking, divisible	<b>P971-1</b>	100	0,038
----------------------	--------------------------------------	---------------	-----	-------

<b>Marking Plate</b>	4-section without marking, divisible	<b>P245-1</b>	100	0,050
----------------------	--------------------------------------	---------------	-----	-------

<b>Marking Plate</b>	marked, choice of K1...K32	<b>P245-K..</b>	100	0,013
----------------------	----------------------------	-----------------	-----	-------

## Coil voltages for AC operated contactors

**Type-suffix for coil-types K6/.. to K45/... for contactor-types K3-07.. to K3-74**

Suffix to contactor type	to coil type	Voltage Marking at the coil		Rated Control Voltage $U_s$ range			
		for 50Hz V	for 60Hz V	for 50Hz min. V	max. V	for 60Hz min. V	max. V
6	41.6	6		6	6,6	6,6	7,3
6,6	41.6,6	6,6		6,6	7,3	7,3	8
7,3	41.7,3	7,3		7,3	8	8	9
8	41.8	8		8	9	9	10
9	41.9	9		9	10	10	11
10	41.10	10		10	11	11	12
11	41.11	11	12	11	12	12	13,2
12	41.12	12		12	13,2	13,2	14,5
13,2	41.13	13,2		13,2	14,5	14,5	16
14,5	41.14	14,5		14,5	16	16	18
16	41.16	16		16	18	18	20
18	41.18	18		18	20	20	22
20	41.20	20		20	22	22	24
<b>24</b>	<b>4.24</b>	<b>24</b>	<b>24</b>	<b>22</b>	<b>24</b>	<b>24</b>	<b>27</b>
25	41.25	25		24	27	27	30
27	41.27	27	32	27	30	30	33
32	41.32	32	36	30	33	33	36
33	41.33	36	36	33	36	36	39
36	41.36	36	42	36	39	39	42
40	41.40	42	42	39	42	42	47
<b>42</b>	<b>4.42</b>	<b>42</b>	<b>48</b>	<b>42</b>	<b>47</b>	<b>47</b>	<b>52</b>
48	41.48	48	48	44	48	48	52
55	41.55	55	60	52	58	58	65
60	41.60	60		58	65	65	72
65	41.65	65		65	72	72	80
75	41.75	75		72	80	80	90
85	41.85	85		80	90	90	100
90	41.90	100	100	90	100	100	110
<b>110</b>	<b>4.110</b>	<b>110</b>	<b>110-120</b>	<b>100</b>	<b>110</b>	<b>110</b>	<b>122</b>
115	41.115	115	125	110	122	122	135
127	41.127	127		122	135	135	150
140	41.140	140		135	150	150	165
150	41.150	150		150	165	165	180
165	41.165	165	180-208	165	180	180	208
180	41.180	180-210 <sup>1)</sup>	200-240 <sup>1)</sup>	180	210 <sup>1)</sup>	200	240 <sup>1)</sup>
190R <sup>2)</sup>	41.190	200-240	200-240	200	240	200	240
200	41.200	200-230 <sup>1)</sup>	220-240	200	230 <sup>1)</sup>	220	240
<b>230</b>	<b>4.230</b>	<b>220-240</b>	<b>230-264</b>	<b>220</b>	<b>240</b>	<b>230</b>	<b>264</b>
254	41.254	254	277	240	264	264	290
270	41.270	270		264	290	290	315
300	41.300	300		290	315	315	345
320	41.320	320		315	345	345	380
345	41.345	345-400 <sup>1)</sup>	380-440 <sup>1)</sup>	345	400 <sup>1)</sup>	380	440 <sup>1)</sup>
390R <sup>2)</sup>	41.390	400-480	400-480	400	480	400	480
<b>400</b>	<b>4.400</b>	<b>380-415</b>	<b>400-440</b>	<b>380</b>	<b>415</b>	<b>400</b>	<b>460</b>
415	41.415	415-440	440-480	400	440	440	480
440	41.440	440-480	480-500	440	480	480	530
480	41.480	480-500	530-580	480	530	530	580
500	41.500	500-550	550-600	500	550	550	600
550	41.550	550-600	600	550	600	600	(650)

### Standard voltages in bold type letters.

- 1) Operating range of magnet-coils:  $0,85 \times U_s$  (min. value of rated control voltage) up to  $1,05 \times U_s$  (max. value of rated control voltage).
- 2) Reduction of mechanical life to 25% of normal life. It is not admissible as a spare coil in a contactor for different coil voltages.

**Type-suffix for coil-types K85/... and K110/... for contactor-types K85 to K110**

Suffix to contactor type	to coil type	Voltage Marking at the coil		Rated Control Voltage $U_s$ range			
		for 50Hz V	for 60Hz V	for 50Hz min. V	max. V	for 60Hz min. V	max. V
20	4.20	20	24	20	22	24	26
24	4.24	24		24	27	29	32
42	4.42	42		42	47	50	56
110	4.110	110-120		110	122	132	146
<b>230</b>	<b>4.230</b>	<b>220-240</b>	<b>277</b>	<b>220</b>	<b>240</b>	<b>264</b>	<b>288</b>
400	4.400	380-415	460-480	380	415	455	498

**Type-suffix for coil-types K3-1200/.. for contactor-types K3-1000.. to K3-1200..**

110	4.110	110-115	-	110	115	110	115
<b>230</b>	<b>4.230</b>	<b>220-230</b>	-	<b>220</b>	<b>230</b>	<b>220</b>	<b>230</b>
<b>400</b>	<b>4.400</b>	<b>380-400</b>	-	<b>380</b>	<b>400</b>	<b>380</b>	<b>400</b>
440	4.440	440	-	440	440	440	440

## Coil voltages for AC and DC operated contactors

**Type-suffix for coil-types K3-115/.. to K3-860/.. for contactor-types K3-90.. to K3-860..**

Suffix to contactor type	to coil type	Voltage Marking at the coil		Rated Control Voltage $U_s$ range			
		for 50/60Hz V	for DC V	for 50Hz min. V	max. V	for 60Hz min. V	max. V
24	4.24	24	24	22	24	22	24
48	4.48	48	48	44	48	44	48
110	4.110	110-120	110	110	120	110	120
<b>230</b>	<b>4.230</b>	<b>220-240</b>	<b>220</b>	<b>220</b>	<b>240</b>	<b>220</b>	<b>240</b>
<b>400</b>	<b>4.400</b>	<b>380-415</b>	-	<b>380</b>	<b>415</b>	<b>380</b>	<b>415</b>

## Coil voltages for AC operated contactors

**Type-suffix for coil-types K3-115/..AC for contactor-types K3-90..AC to K3-115..AC**

Suffix to contactor type	to coil type	Voltage Marking at the coil		Rated Control Voltage $U_s$ range			
		for 50Hz V	for 60Hz V	for 50Hz min. V	max. V	for 60Hz min. V	max. V
<b>110AC</b>	<b>4.110AC</b>	110-122	132-146	110	122	132	146
<b>230AC</b>	<b>4.230AC</b>	<b>220-240</b>	<b>277</b>	<b>220</b>	<b>240</b>	<b>264</b>	<b>288</b>

Other coil voltages on request

**Operating range of magnet-coils:  $0,85 \times U_s$  (min. value of rated control voltage) up to  $1,1 \times U_s$  (max. value of rated control voltage)**

With reduced control voltage range  $0,9$  up to  $1,0 \times U_s$  at ambient temperature  $60 - 90^\circ\text{C}$ .

## Spare Coils for AC operated contactors



For Contactors

	Type	Coil voltage <sup>1)</sup>	Pack pcs.	Weight kg/pc.
K3-07N.. up to K3-22N..	<b>K10N/...EUR</b>	24V 50Hz	1	0,053
K3-24.. up to K3-40.. <b>3 pole contactor</b>	<b>K24/...</b>	42V 50Hz	1	0,085
K3-24.. up to K3-40.. <b>4 pole contactor</b>	<b>K24-4/...</b>	110V 50Hz	1	0,085
K3-50.. up to K3-74.. <b>3 pole contactor</b>	<b>K45/...</b>	180V 50Hz, 220V 60Hz	1	0,110
K3-50.. up to K3-74.. <b>4 pole contactor</b>	<b>K50/...</b>	220-240V 50Hz	1	0,110
K3-90.., K3-115.. (AC/DC coil)	<b>K3-115/...</b>	380-415V 50Hz	1	0,230

For Contactors

	Type	Coil voltage <sup>1)</sup>	Pack pcs.	Weight kg/pc.
K3-1000..., K3-1200.. without feeder group <sup>2)</sup>	<b>K3-1200/...</b>	110V 50Hz, 110-115V 60Hz	1	3,12
		220-230V 50Hz		
		380-400V 50Hz		

## Spare Coils for AC and DC operated contactors



For Contactors

	Type	Coil voltage <sup>1)</sup>	Pack pcs.	Weight kg/pc.
K3-90.., K3-115.. with feeder group	<b>K3-115/...</b>	24V 50/60Hz / 24V DC	1	0,30
K3-151.., K3-176.. with feeder group	<b>K3-176/...</b>	110-120V 50/60Hz / 110V DC	1	0,68
K3-210.., K3-316.. with feeder group	<b>K3-316/...</b>	220-240V 50/60Hz / 220V DC	1	0,68
K3-450.., K3-550.. without feeder group <sup>2)</sup>	<b>K3-550/...</b>	380-415V 50/60Hz	1	1,63
K3-700.., K3-860.. without feeder group <sup>2)</sup>	<b>K3-860/...</b>		1	2,44

## Spare Feeder Groups for contactors K3-450.. to K3-860..

In case of changing control voltage, change coil and feeder group too

For Contactors

	Type	Coil voltage <sup>1)</sup>	Pack pcs.	Weight kg/pc.
K3-450.., K3-550.. K3-550/4...	<b>K3-550/FG ...</b>	110-120V 50/60Hz / 110V DC	1	0,33
K3-700.., K3-860.. K3-860/4...	<b>K3-860/FG ...</b>	220-240V 50/60Hz / 220V DC	1	0,54
		380-415V 50/60Hz		

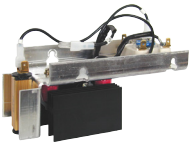

1) Coil voltage range and non-standard coil voltages see page 57.

2) In case of changing control voltage, change coil and feeder group too.

# Spare Coils for DC operated contactors

Aux. Contact Block for dual-wound coil

Type	Coil voltage <sup>1)</sup>
<b>47.24=</b>	24V DC
<b>48.48=</b>	48V DC
<b>47.110=</b>	110V DC
<b>47.220=</b>	220V DC

For Contactors

For Contactors	Aux. Contact Block for dual-wound coil	Type	Coil voltage <sup>1)</sup>	Pack pcs.	Weight kg/pc.
K3-07N..= up to K3-22N..=	HN01U	<b>K10N/ ...</b>	24V DC	1	0,052
K3-24..= up to K3-40..=	HN01U	<b>K24/ ...</b>	48V DC	1	0,090
K3-24..= up to K3-40..=	HN01U	<b>K24-4/ ...</b>	110V DC	1	0,090
K3-50..= up to K3-74..=	HN01Z	<b>K45/ ...</b>	220V DC	1	0,115
K3-50..= up to K3-74..=	HN01Z	<b>K50/ ...</b>		1	0,115
K3-90.., K3-115.. (AC/DC coil)	-	see page 58		1	0,230



Type	Coil voltage <sup>1)</sup>
<b>43.110</b>	110V DC
<b>43.220</b>	220V DC

For Contactors

For Contactors	Aux. Contact Block for dual-wound coil	Type	Coil voltage <sup>1)</sup>	Pack pcs.	Weight kg/pc.
K3-1000..=, K3-1200..=	without feeder group <sup>2)</sup>	<b>K3-1200/ ...</b>	220V DC	1	3,12

## Wiring Diagrams for Coil Circuit

AC operated

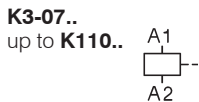

DC operated with dual-wound coil

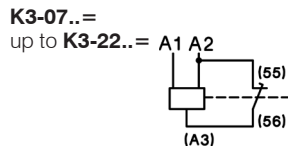

DC operated

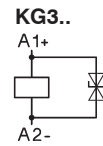

AC and DC operated with dual-wound coil  
**K3-90A00, K3-115A00**  
**K3-151A00, K3-176A00**  
**K3-210A00 to K3-316A00**

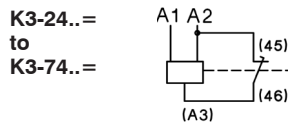
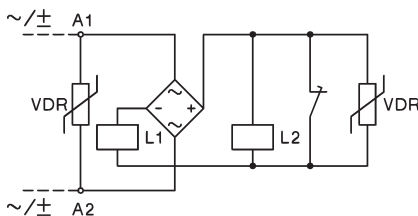

AC and DC operated with series resistor  
**K3-200A21**  
**K3-315A21**

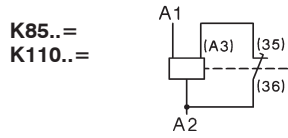
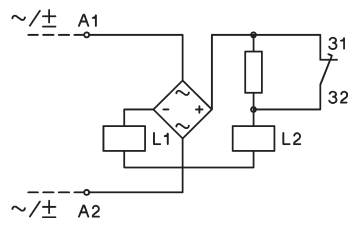

AC and DC operated with series resistor  
**K3-450..** up to **K3-860..**

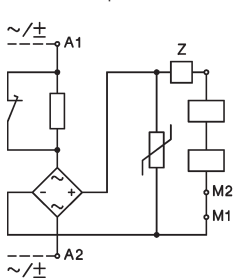

DC operated with DC coil  
**K3-1000.., K3-1200..**

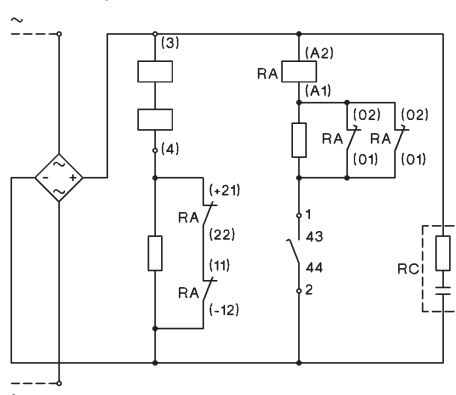

AC operated with DC coil  
**K3-1000.., K3-1200..**

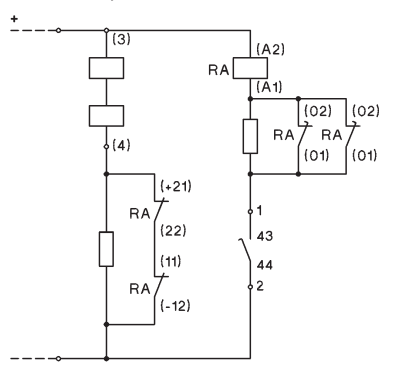

Adjustable dropout operating time for K3-450.. to K3-860..  
150-200ms: Wiring see above (delivery standard)  
500-1000ms: Jumper device "Z"  
approx. 20ms: Special wiring see package folder

Contactors K3-1000.., K3-1200..  
For control voltages up to 125V  
NC contacts 21-22 and 11-12 are connected parallel,  
for higher voltages contacts are connected in series (delivery standard).

1) Other coil voltages on request.  
2) In case of changing control voltage, change coil and feeder group too.

## Spare Contacts

<b>Main Contacts</b> for Contactors	<b>Type</b>	Pack pcs.	Weight kg/pc.
K85..	<b>EK85/1</b>	3	0,235
K110..	<b>EK110/1</b>	3	0,275
K3-150..	<b>EK3-150/10</b>	1	0,32
K3-151..	<b>EK3-151/10</b>	1	0,16
K3-175..	<b>EK3-175/10</b>	1	0,32
K3-176..	<b>EK3-176/10</b>	1	0,16
K3-200..	<b>EK3-200/10</b>	1	0,18
K3-210..	<b>EK3-210/10</b>	1	0,18
K3-260..	<b>EK3-260/10</b>	1	0,30
K3-315..	<b>EK3-315/10</b>	1	0,34
K3-316..	<b>EK3-316/10</b>	1	0,34
K3-450..	<b>EK3-450/10</b>	1	0,35
K3-550..	<b>EK3-550/10</b>	1	0,35
K3-700..	<b>EK3-700/10</b>	1	0,85
K3-860..	<b>EK3-860/10</b>	1	1,0
K3-1000..	<b>EK3-1000/10</b>	1	1,4
K3-1200..	<b>EK3-1200/10</b>	1	1,4

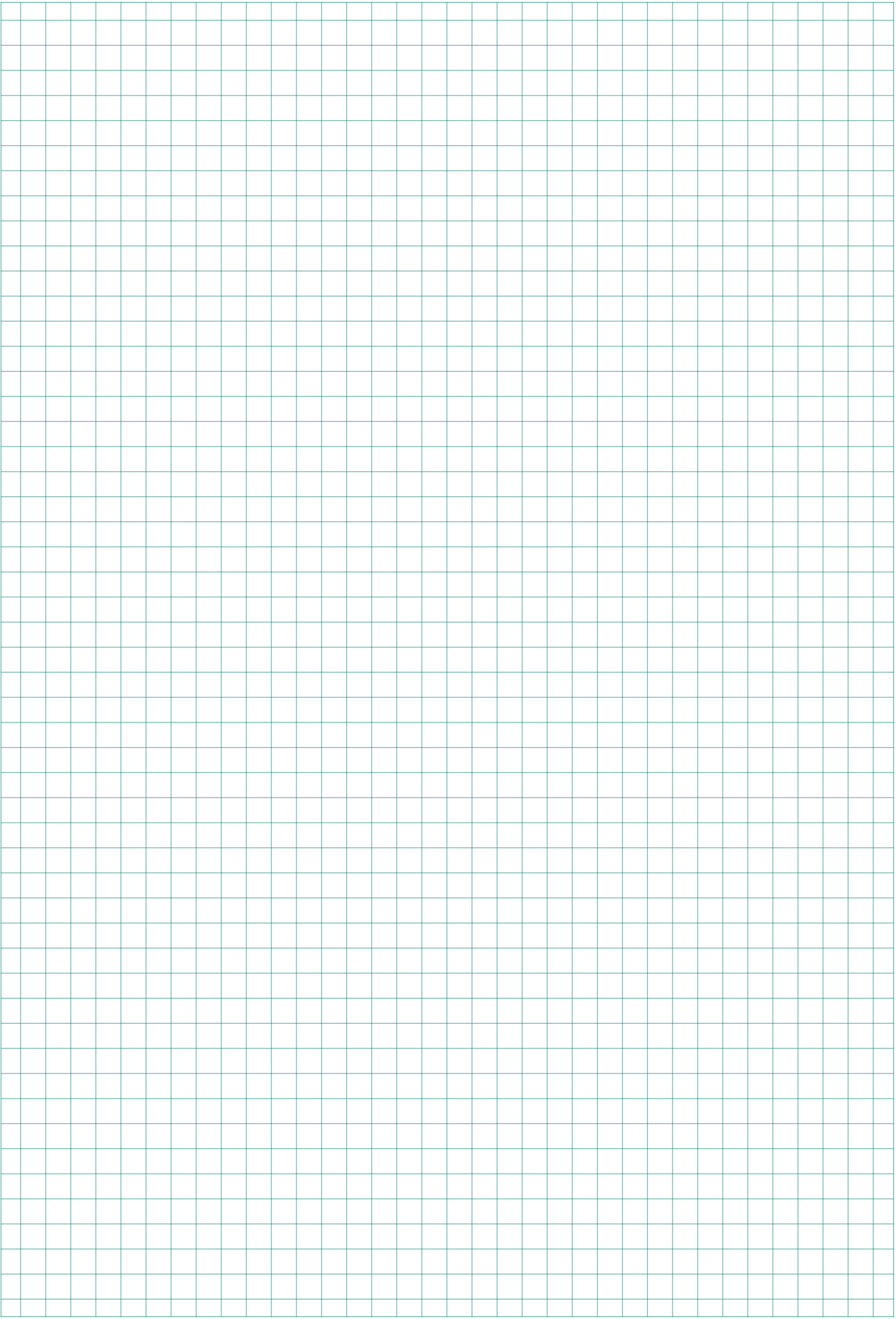

Contactors, Motor-Starter

Circuit Breakers

Manual Motor-Starters

Switches

AC-Main Switches

DC-Switch Disconnect

Push Buttons

Representatives, Suppliers

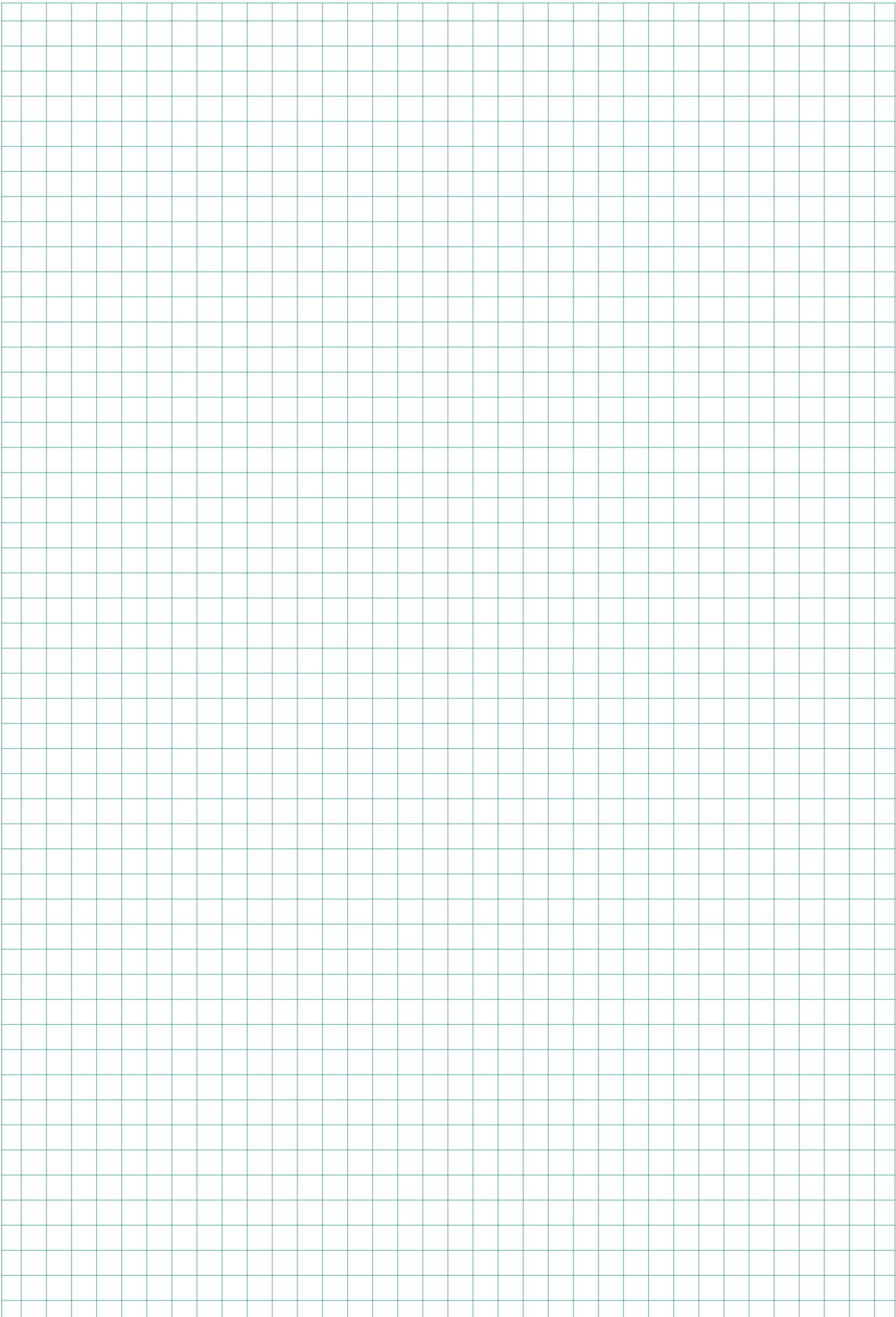

# Approximate Values for three-phase Motors

## Motor Full Load Currents

Approximate values of motor F.L.C. and minimum "slow blow" respectively "gL" short-circuit fuse

Motor rating kW	Range acc. to BS for 415V				220-230V Motor fuse size motor start			240V Motor fuse size motor start			380-400V Motor fuse size motor start			415V Motor fuse size motor start			500V Motor fuse size motor start			660-690V Motor fuse size motor start		
	PS~hp	hp	cosφ	%	I <sub>n</sub>	D.O.L.	YD	I <sub>n</sub>	D.O.L.	YD	I <sub>n</sub>	D.O.L.	YD	I <sub>n</sub>	D.O.L.	YD	I <sub>n</sub>	D.O.L.	YD	I <sub>n</sub>	D.O.L.	YD
<b>0,06</b>	0,08	-	0,7	59	0,38	1	1	0,35	1	1	<b>0,22</b>	1	1	-	-	-	0,16	1	1	-	-	-
<b>0,09</b>	0,12	-	0,7	60	0,55	2	2	0,5	2	2	<b>0,33</b>	1	1	-	-	-	0,24	1	1	-	-	-
<b>0,12</b>	0,16	-	0,7	61	0,76	2	2	0,68	2	2	<b>0,42</b>	2	2	-	-	-	0,33	1	1	-	-	-
<b>0,18</b>	0,24	-	0,7	61	1,1	2	2	1	2	2	<b>0,64</b>	2	2	-	-	-	0,46	1	1	-	-	-
<b>0,25</b>	0,34	-	0,7	62	1,4	4	2	1,38	4	2	<b>0,88</b>	2	2	-	-	-	0,59	2	2	-	-	-
<b>0,37</b>	0,5	-	0,72	64	2,1	4	4	1,93	4	4	<b>1,22</b>	4	2	-	-	-	0,85	2	2	0,7	2	2
<b>0,55</b>	0,75	-	0,75	69	2,7	4	4	2,3	4	4	<b>1,5</b>	4	2	-	-	-	1,2	4	2	0,9	2	2
<b>0,75</b>	1	1	0,8	74	3,3	6	4	3,1	6	4	<b>2</b>	4	4	2	4	4	1,48	4	2	1,1	2	2
<b>1,1</b>	1,5	1,5	0,83	77	4,9	10	6	4,1	6	6	<b>2,6</b>	4	4	2,5	4	4	2,1	4	4	1,5	4	2
<b>1,5</b>	2	2	0,83	78	6,2	10	10	5,6	10	10	<b>3,5</b>	6	4	3,5	6	4	2,6	4	4	2	4	4
<b>2,2</b>	3	3	0,83	81	8,7	16	10	7,9	16	10	<b>5</b>	10	6	5	10	6	3,8	6	6	2,9	6	4
<b>2,5</b>	3,4	-	0,83	81	9,8	16	16	8,9	16	10	<b>5,7</b>	10	10	-	-	-	4,3	6	6	-	-	-
<b>3</b>	4	4	0,84	81	11,6	20	16	10,6	20	16	<b>6,6</b>	16	10	6,5	16	10	5,1	10	10	3,5	6	4
<b>3,7</b>	5	5	0,84	82	14,2	25	20	13	25	16	<b>8,2</b>	16	10	7,5	16	10	6,2	16	10	-	-	-
<b>4</b>	5,5	-	0,84	82	15,3	25	20	14	25	20	<b>8,5</b>	16	10	-	-	-	6,5	16	10	4,9	10	6
<b>5,5</b>	7,5	7,5	0,85	83	20,6	35	25	18,9	35	25	<b>11,5</b>	20	16	11	20	16	8,9	16	10	6,7	16	10
<b>7,5</b>	10	10	0,86	85	27,4	50	35	24,8	50	35	<b>15,5</b>	25	20	24	25	16	11,9	20	16	9	16	10
<b>8</b>	11	-	0,86	85	28,8	50	35	26,4	50	35	<b>16,7</b>	25	20	-	-	-	12,7	20	16	-	-	-
<b>11</b>	15	15	0,86	87	39,2	63	50	35,3	63	50	<b>22</b>	35	25	21	35	25	16,7	25	20	13	25	16
<b>12,5</b>	17	-	0,86	87	43,8	63	50	40,2	63	50	<b>25</b>	35	25	-	-	-	19	35	25	-	-	-
<b>15</b>	20	20	0,86	87	52,6	80	63	48,2	80	63	<b>30</b>	50	35	28	35	35	22,5	35	25	17,5	25	20
<b>18,5</b>	25	25	0,86	88	64,9	100	80	58,7	100	80	<b>37</b>	63	50	35	50	50	28,5	50	35	21	35	25
<b>20</b>	27	-	0,86	88	69,3	100	80	63,4	100	80	<b>40</b>	63	50	-	-	-	30,6	50	35	-	-	-
<b>22</b>	30	30	0,87	89	75,2	100	80	68	100	80	<b>44</b>	63	50	40	63	50	33	50	35	25	35	35
<b>25</b>	34	-	0,87	89	84,4	125	100	77,2	100	100	<b>50</b>	80	63	-	-	-	38	63	50	-	-	-
<b>30</b>	40	40	0,87	90	101	125	125	92,7	125	100	<b>60</b>	80	63	55	80	63	44	63	50	33	50	35
<b>37</b>	50	50	0,87	90	124	160	160	114	160	125	<b>72</b>	100	80	66	100	80	54	80	63	42	63	50
<b>40</b>	54	-	0,87	90	134	160	160	123	160	160	<b>79</b>	100	100	-	-	-	60	80	63	-	-	-
<b>45</b>	60	60	0,88	91	150	200	160	136	200	160	<b>85</b>	125	100	80	100	100	64,5	100	80	49	63	63
<b>51</b>	70	-	0,88	91	168	200	200	154	200	200	<b>97</b>	125	100	-	-	-	73,7	100	80	-	-	-
<b>55</b>	75	-	0,88	91	181	250	200	166	200	200	<b>105</b>	160	125	-	-	-	79	125	100	60	80	63
<b>59</b>	80	80	0,88	91	194	250	200	178	250	200	<b>112</b>	160	125	105	160	125	85,3	125	100	-	-	-
<b>75</b>	100	100	0,88	91	245	315	250	226	315	250	<b>140</b>	200	160	135	200	160	106	160	125	82	125	100
<b>90</b>	125	125	0,88	92	292	400	315	268	315	315	<b>170</b>	250	200	165	200	200	128	160	160	98	125	125
<b>110</b>	150	150	0,88	92	358	500	400	327	400	400	<b>205</b>	250	200	200	250	250	156	200	200	118	160	125
<b>129</b>	175	175	0,88	92	420	500	500	384	500	400	<b>242</b>	315	250	230	315	250	184	250	200	-	-	-
<b>132</b>	180	-	0,88	92	425	500	500	393	500	500	<b>245</b>	315	250	-	-	-	186	250	200	140	200	160
<b>147</b>	200	200	0,88	93	472	630	630	432	630	500	<b>273</b>	315	315	260	315	315	207	250	250	-	-	-
<b>160</b>	220	-	0,88	93	502	630	630	471	630	630	<b>295</b>	400	315	-	-	-	220	315	250	170	200	200
<b>184</b>	250	250	0,88	93	590	800	630	541	630	630	<b>340</b>	400	400	325	400	400	259	315	315	-	-	-
<b>200</b>	270	-	0,88	93	626	800	800	589	800	630	<b>370</b>	500	400	-	-	-	278	315	315	215	250	250
<b>220</b>	300	300	0,88	93	700	1000	800	647	800	800	<b>408</b>	500	500	385	500	400	310	400	400	-	-	-
<b>250</b>	340	-	0,88	93	803	1000	1000	736	1000	800	<b>460</b>	630	500	-	-	-	353	500	400	268	315	315
<b>257</b>	350	350	0,88	93	826	1000	1000	756	1000	800	<b>475</b>	630	630	450	630	500	363	500	400	-	-	-
<b>295</b>	400	400	0,88	93	948	1250	1000	868	1000	1000	<b>546</b>	800	630	500	630	630	416	500	500	-	-	-
<b>315</b>	430	-	0,88	93	990	1250	1250	927	1250	1000	<b>580</b>	800	630	-	-	-	445	630	500	337	400	400
<b>355</b>	483	-	0,89	95	-	-	-	-	-	-	<b>636</b>	800	800	-	-	-	483	630	630	366	500	400
<b>400</b>	545	-	0,89	96	-	-	-	-	-	-	<b>710</b>	1000	800	-	-	-	538	630	630	410	500	500

The motor F.L.C. be valid for standard internal and surface cooled three-phase motors with 1500 min<sup>-1</sup>. The fuses values be valid for the motor F.L.C. shown in the table and D.O.L.-start: starting current max. 6x motor F.L.C., starting time max. 5s; star-delta-start: starting current max. 2x motor F.L.C., starting time max. 15s

For motors with higher F.L.C., higher starting current and / or longer starting time, larger short-circuit fuses are required. The maximum admissible value is dependent on the switchgear respectively thermal overload relay.

## Approximate values of motor F.L.C. according to CSA and UL

Motor rating hp	Motor F.L.C. at 110-120V			Motor F.L.C. at 220-240V <sup>1)</sup>			Motor F.L.C. at 440-480V			Motor F.L.C. at 550-600V		
	1-phase	2-phase	3-phase	1-phase	2-phase	3-phase	1-phase	2-phase	3-phase	1-phase	2-phase	3-phase
1/2	9.8	4.0	4.4	4.9	2.0	2.2	2.5	1.0	1.1	2.0	0.8	0.9
3/4	13.8	4.8	6.4	6.9	2.4	3.2	3.5	1.2	1.6	2.8	1.0	1.3
1	16.0	6.4	8.4	8.0	3.2	4.2	4.0	1.6	2.1	3.2	1.3	1.7
1-1/2	20.0	9.0	12.0	10.0	4.5	6.0	5.0	2.3	3.0	4.0	1.8	2.4
2	24.0	11.8	13.6	12.0	5.9	6.8	6.0	3.0	3.4	4.8	2.4	2.7
3	34.0	16.6	19.2	17.0	8.3	9.6	8.5	4.2	4.8	6.8	3.3	3.9
5	56.0	26.4	30.4	28.0	13.2	15.2	14.0	6.6	7.6	11.2	5.3	6.1
7-1/2	80.0	38.0	44.0	40.0	19.0	22.0	21.0	9.0	11.0	16.0	8.0	9.0
10	100.0	48.0	56.0	50.0	24.0	28.0	26.0	12.0	14.0	20.0	10.0	11.0
15	135.0	72.0	84.0	68.0	36.0	42.0	34.0	18.0	21.0	27.0	14.0	17.0
20	-	94.0	108.0	88.0	47.0	54.0	44.0	23.0	27.0	35.0	19.0	22.0
25	-	118.0	136.0	110.0	59.0	68.0	55.0	29.0	34.0	44.0	24.0	27.0
30	-	138.0	160.0	136.0	69.0	80.0	68.0	35.0	40.0	54.0	28.0	32.0
40	-	180.0	208.0	176.0	90.0	104.0	88.0	45.0	52.0	70.0	36.0	41.0
50	-	226.0	260.0	216.0	113.0	130.0	108.0	56.0	65.0	86.0	45.0	52.0
60	-	-	-	-	133.0	145.0	-	67.0	77.0	-	53.0	62.0
75	-	-	-	-	166.0	192.0	-	83.0	96.0	-	66.0	77.0
100	-	-	-	-	218.0	248.0	-	109.0	124.0	-	87.0	99.0
125	-	-	-	-	-	312.0	-	135.0	156.0	-	108.0	125.0

# Contactors

## Data according to IEC 947-4-1, EN 60947-4-1, VDE 0660

Main Contacts	Type	K(G)3-10	K(G)3-14	K(G)3-18	K(G)3-22	K(G)3-24	K(G)3-32	K(G)3-40	K3-50	K3-62	K3-74	
<b>Rated insulation voltage</b> $U_i^{1)}$	V AC	690	690	690	690	690	690	690	830	830	830	
<b>Making capacity</b> $I_{eff}$ at $U_e = 690V$ AC	A	200	200	200	200	400	500	500	700	900	900	
	1000V AC	-	-	-	-	-	-	-	-	-	-	
<b>Breaking capacity</b> $I_{eff}$	400V AC	180	180	200	200	380	400	400	600	800	800	
K3-10 to K3-22 $\cos\varphi = 0,65$	500V AC	150	150	180	180	300	370	370	500	700	700	
K3-24 to K3-1200 $\cos\varphi = 0,35$	690V AC	100	100	150	150	260	340	340	400	500	500	
	1000V AC	-	-	-	-	-	-	-	-	-	-	
<b>Utilization category AC1</b>												
<b>Switching of resistive load</b>												
Rated operational current $I_e (=I_{th})$ at 40°C, open	690V	<b>A</b>	<b>25</b>	<b>25</b>	<b>32</b>	<b>32</b>	<b>50</b>	<b>65</b>	<b>80</b>	<b>110</b>	<b>120</b>	<b>130</b>
Rated operational power of three-phase resistive loads 50-60Hz, $\cos\varphi = 1$	220V	kW	9,5	9,5	12,2	12,2	19,0	24,7	30,4	41,9	45,7	49,5
	230V	kW	9,9	9,9	12,7	12,7	19,9	25,9	31,8	43,8	47,7	51,7
	240V	kW	10,4	10,4	13,3	13,3	20,8	27,0	33,2	45,7	49,8	54,0
	380V	kW	16,4	16,4	21,0	21,0	32,9	42,7	52,6	72,3	78,9	85,5
	400V	kW	17,3	17,3	22,1	22,1	34,6	45,0	55,4	76,1	83,0	90,0
	415V	kW	17,9	17,9	23,0	23,0	35,9	46,7	57,4	79,0	86,2	93,3
	440V	kW	19,0	19,0	24,4	24,4	38,1	49,5	60,9	83,7	91,3	99,0
	500V	kW	21,6	21,6	27,7	27,7	43,3	56,2	69,2	95,2	103,8	112,5
	660V	kW	28,5	28,5	36,5	36,5	57,1	74,2	91,3	125,6	137,0	148,4
	690V	kW	29,8	29,8	38,2	38,2	59,7	77,6	95,5	131,3	143,2	155,2
	1000V	kW	-	-	-	-	-	-	-	-	-	-
Rated operational current $I_e (=I_{th})$ at 40°C, inside the enclosure 60°C	690V	A	25	25	32	32	40	55	65	90	100	110
Rated operational power of three-phase resistive loads 50-60Hz, $\cos\varphi = 1$	220V	kW	9,5	9,5	12,2	12,2	15,2	20,9	24,7	34,3	38,1	41,9
	230V	kW	9,9	9,9	12,7	12,7	15,9	21,9	25,9	35,8	39,8	43,8
	240V	kW	10,4	10,4	13,3	13,3	16,6	22,8	27,0	37,4	41,5	45,7
	380V	kW	16,4	16,4	21,0	21,0	26,3	36,2	42,7	59,2	65,7	72,3
	400V	kW	17,3	17,3	22,1	22,1	27,7	38,1	45,0	62,3	69,2	76,1
	415V	kW	17,9	17,9	23,0	23,0	28,7	39,5	46,7	64,6	71,8	79,0
	440V	kW	19,0	19,0	24,4	24,4	30,4	41,9	49,5	68,5	76,1	83,7
	500V	kW	21,6	21,6	27,7	27,7	34,6	47,6	56,2	77,9	86,5	95,2
	660V	kW	28,5	28,5	36,5	36,5	45,7	62,8	74,2	102,8	114,2	125,6
	690V	kW	29,8	29,8	38,2	38,2	47,7	65,7	77,6	107,4	119,4	131,3
	1000V	kW	-	-	-	-	-	-	-	-	-	-
Minimum cross-section of conductor at load with $I_e (=I_{th})$		mm <sup>2</sup>	4	4	6	6	10	16	25	35	50	50
<b>Utilization category AC2 and AC3</b>												
<b>Switching of three-phase motors</b>												
Rated operational current $I_e$ open and enclosed	220V	A	12	15	18	22	24	32	40	50	63	74
	230V	A	11,5	14,5	18	22	24	32	40	50	62	74
	240V	A	11	14	18	22	24	32	40	50	62	74
	<b>380-400V</b>	<b>A</b>	<b>10</b>	<b>14</b>	<b>18</b>	<b>22</b>	<b>24</b>	<b>32</b>	<b>40</b>	<b>50</b>	<b>62</b>	<b>74</b>
	415V	A	9	14	18	22	23	30	40	50	62	74
	440V	A	9	14	18	22	23	30	40	50	62	74
	500V	A	8,9	11,9	15	15	22,5	28,5	28,5	44	54	64,5
	660-690V	A	6,7	9	12	12	17,5	21	21	33	42	49
	1000V	A	-	-	-	-	-	-	-	-	-	-
Rated operational power of three-phase motors 50-60Hz	220-230V	kW	3	4	5	6	6	8,5	11	12,5	18,5	22
	240V	kW	3	4	5	7	7	9	11,5	13,5	19	23
	<b>380-400V</b>	<b>kW</b>	<b>4</b>	<b>5,5</b>	<b>7,5</b>	<b>11</b>	<b>11</b>	<b>15</b>	<b>18,5</b>	<b>22</b>	<b>30</b>	<b>37</b>
	415V	kW	4,5	6	8,5	12	12	16	20	24	33	40
	440V	kW	4,5	6	8,5	12	12	16	20	24	33	40
	500V	kW	5,5	7,5	10	10	15	18,5	18,5	30	37	45
	660-690V	kW	5,5	7,5	10	10	15	18,5	18,5	30	37	45
	1000V	kW	-	-	-	-	-	-	-	-	-	-

1) Suitable at 690V for: earthed-neutral systems, overvoltage category I to IV, pollution degree 3 (standard-industry):  $U_{imp} = 8kV$ .  
Data for other conditions on request.

# Contactors

Data according to IEC 947-4-1, EN 60947-4-1, VDE 0660

Type	K3-90	K3-115	K3-116	K3-151	K3-176	K3-210	K3-260	K3-316	K3-450	K3-550	K3-700	K3-860	K3-1000	K3-1200
V AC	1000	1000	1000	1000	1000	1000	1000	1000	1000	1000	690	690	690	690
A	1100	1200	1200	1500	2000	2100	2600	3200	4500	5500	7000	8600	10000	12000
A	540	600	600	720	840	1020	1200	1500	2400	3000	-	-	-	-
A	950	1100	1000	1200	1500	1600	2100	2600	4500	5500	7000	8000	8000	10000
A	850	1000	1000	1200	1500	1600	2100	2600	4500	5500	7000	8000	8000	10000
A	600	600	800	1000	800	1200	1900	2300	3200	4400	5600	6900	7000	8000
A	450	450	400	500	600	700	850	1000	-	-	-	-	-	-
<b>A</b>	<b>160</b>	<b>200</b>	<b>200</b>	<b>250</b>	<b>300</b>	<b>350</b>	<b>450</b>	<b>600</b>	<b>700</b>	<b>800</b>	<b>1000</b>	<b>1100</b>	<b>1200</b>	<b>1350</b>
kW	60	76	76	95	114	133	171	228	266	304	381	419	457	514
kW	63	79	79	99	119	139	179	238	279	318	398	438	478	537
kW	66	83	83	103	124	145	187	249	291	332	415	457	498	561
kW	105	131	131	165	197	230	296	394	460	526	658	724	789	888
kW	110	138	138	173	208	242	311	415	485	554	692	762	831	935
kW	115	143	143	179	215	251	323	430	503	574	718	790	862	970
kW	121	152	152	190	228	266	342	456	533	609	762	838	914	1028
kW	138	173	173	216	260	303	389	518	606	692	866	952	1039	1169
kW	182	228	228	285	343	400	514	684	800	914	1143	1257	1371	1543
kW	191	239	239	298	358	418	537	715	836	955	1195	1314	1434	1613
kW	221	277	216	345	415	433	546	727	692	911	-	-	-	-
A	145	170	170	180	200	280	360	400	550	600	800	875	960	1080
kW	55	64	64	68	76	106	137	152	209	228	304	333	365	411
kW	57	67	67	71	79	111	143	159	219	239	318	348	382	430
kW	59	70	70	74	83	116	150	166	228	249	332	363	399	448
kW	95	111	111	118	131	184	237	263	362	395	526	575	631	710
kW	100	117	117	124	138	193	249	277	381	415	554	606	665	748
kW	104	122	122	129	143	201	259	287	395	431	575	628	690	776
kW	110	129	129	137	152	213	274	304	419	457	609	666	731	823
kW	125	147	147	155	173	242	312	346	476	519	692	757	831	935
kW	165	194	194	205	228	320	412	457	628	685	914	1000	1097	1234
kW	173	202	202	215	239	334	430	478	657	717	956	1045	1147	1290
kW	166	187	216	277	346	388	499	554	692	866	-	-	-	-
mm²	95	120	95	95	120	240	2x150	2x(30x6)	2x(40x5)	2x(50x5)	2x(60x5)	2x(60x6)	2x(60x6)	2x(60x8)
A	90	115	115	150	175	210	260	315	450	550	700	860	1000	1200
A	90	115	115	150	175	210	260	315	450	550	700	860	1000	1200
A	90	115	115	150	175	210	260	315	450	550	700	860	1000	1200
<b>A</b>	<b>90</b>	<b>115</b>	<b>115</b>	<b>150</b>	<b>175</b>	<b>210</b>	<b>260</b>	<b>315</b>	<b>450</b>	<b>550</b>	<b>700</b>	<b>860</b>	<b>1000</b>	<b>1200</b>
A	90	115	115	150	175	210	260	315	450	550	700	860	1000	1200
A	90	115	115	150	175	210	260	315	450	550	700	860	1000	1200
A	79	79	115	150	175	210	260	315	450	550	700	860	1000	1200
A	60	60	100	120	140	150	180	240	400	500	630	700	860	1000
A	45	45	45	60	70	85	100	125	200	250	-	-	-	-
kW	25	33	30	40	50	60	75	90	132	175	225	280	325	390
kW	27	35	35	45	55	65	80	100	140	185	235	290	335	400
<b>kW</b>	<b>45</b>	<b>55</b>	<b>55</b>	<b>75</b>	<b>90</b>	<b>110</b>	<b>132</b>	<b>160</b>	<b>250</b>	<b>300</b>	<b>400</b>	<b>500</b>	<b>580</b>	<b>680</b>
kW	49	63	59	80	95	115	140	180	257	315	415	515	600	710
kW	49	63	63	85	100	125	150	190	270	335	450	530	630	750
kW	55	55	75	90	100	132	160	210	300	375	500	600	720	850
kW	55	55	90	110	132	132	160	210	375	500	630	700	850	1000
kW	55	55	55	75	90	110	132	160	280	355	-	-	-	-

# Contactors

## Data according to IEC 947-4-1, EN 60947-4-1, VDE 0660

Main Contacts	Type	K(G)3-10	K(G)3-14	K(G)3-18	K(G)3-22	K(G)3-24	K(G)3-32	K(G)3-40	K3-50	K3-62	K3-74
<b>Utilization category AC4</b>											
<b>Switching of squirrel cage motors, inching</b>											
Rated operational current $I_e$	220V A	12	15	18	18	24	30	40	50	63	63
open and enclosed	230V A	11,5	14,5	18	18	24	30	40	50	62	62
	240V A	11	14	18	18	24	32	40	50	62	62
	<b>380-400V A</b>	<b>10</b>	<b>14</b>	<b>18</b>	<b>18</b>	<b>24</b>	<b>32</b>	<b>40</b>	<b>50</b>	<b>62</b>	<b>62</b>
	415V A	9	14	18	18	23	30	37	45	60	60
	440V A	9	14	18	18	23	30	37	45	55	55
	500V A	9	12	16	16	17,5	21	21	33	42	42
	660V A	7	9	9	9	17	20	20	31	40	40
	690V A	6,5	8,5	8,5	8,5	17	20	20	31	40	40
	1000V A	-	-	-	-	-	-	-	-	-	-
Rated operational power of three-phase motors 50-60Hz	220-230V kW	3	4	5	5	6	8,5	11	12,5	18,5	18,5
	240V kW	3	4	5	5	7	9	11,5	13,5	19	19
	<b>380-400V kW</b>	<b>4</b>	<b>5,5</b>	<b>7,5</b>	<b>7,5</b>	<b>11</b>	<b>15</b>	<b>18,5</b>	<b>22</b>	<b>30</b>	<b>30</b>
	415V kW	4,5	6	8,5	8,5	12	16	20	24	33	33
	440V kW	4,5	6	8,5	8,5	12	16	20	24	33	33
	500V kW	5,5	7,5	10	10	15	18,5	18,5	30	37	37
	660-690V kW	5,5	7,5	10	10	15	18,5	18,5	30	37	37
	1000V kW	-	-	-	-	-	-	-	-	-	-
<b>Utilization category AC5a</b>											
<b>Switching of gas discharge lamps</b>											
Rated operational current $I_e$ per pole at 220/230V											
Fluorescent lamps, uncompensated and serial compensated											
	A	20	20	25	25	40	52	64	88	96	104
	A	7	9	9	9	18	22	22	30	40	40
	A	22,5	22,5	28	28	45	58	72	98	108	117
Metal halide lamps <sup>1)</sup> , uncompensated											
	A	12	15	19	19	30	39	48	66	72	78
	A	7	9	9	9	18	22	22	30	40	40
Mercury-vapour lamps <sup>2)</sup> , uncompensated											
	A	22,5	25	28	28	45	58	72	99	108	117
	A	7	9	9	9	18	22	22	30	40	40
Mixed light lamps <sup>3)</sup>											
	A	20	20	25	25	40	52	64	88	96	104
<b>LED-Lamps</b>											
consider the inrush current of the lamp ballast and $\cos\phi$ of the lamp.											
max. lamps per pole ( $I_{rLED} \leq I_{rn}$ )						= $\frac{\text{inrush current of contactor}}{\text{inrush current of lamp/EVG}}$					
max inrush current of contactor	A	282	282	282	282	564	705	705	987	1269	1268
<b>Utilization category AC5b</b>											
<b>Switching of incandescent lamps <sup>4)</sup></b>											
Rated operational current $I_e$ per pole at 220/230V											
	A	12,5	12,5	12,5	12,5	25	31	31	43	56	56

1) Metal halide lamps and sodium-vapour lamps (high- and low-pressure lamps)

2) High-pressure lamps

3) Blended lamps, containing a mercury high-pressure unit and a tungsten helix in a fluorescent glass bulb (daylight lamps)

4) Current inrush approx.  $16 \times I_e$

# Contactors

Data according to IEC 947-4-1, EN 60947-4-1, VDE 0660

Type	K3-90	K3-115	K3-151	K3-176	K3-210	K3-260	K3-316	K3-450	K3-550	K3-700	K3-860	K3-1000	K3-1200
A	85	98	55	63	85	100	120	150	180	230	280	340	400
A	85	98	55	63	85	100	120	150	180	230	280	340	400
A	85	98	55	63	85	100	120	150	180	230	280	340	400
<b>A</b>	<b>85</b>	<b>85</b>	<b>55</b>	<b>63</b>	<b>85</b>	<b>100</b>	<b>120</b>	<b>150</b>	<b>180</b>	<b>230</b>	<b>280</b>	<b>340</b>	<b>400</b>
A	85	85	55	63	85	100	120	150	180	230	280	340	400
A	85	85	55	63	85	100	120	150	180	230	280	340	400
A	85	85	-	-	-	-	-	-	-	-	-	-	-
A	60	60	-	-	-	-	-	-	-	-	-	-	-
A	57,5	57,5	-	-	-	-	-	-	-	-	-	-	-
A	-	-	-	-	-	-	-	-	-	-	-	-	-
kW	25	30	15	18,5	25	30	37	45	51	68	80	110	132
kW	27	32	15,5	19	26	31	38	47	53	71	83	115	137
<b>kW</b>	<b>45</b>	<b>45</b>	<b>25</b>	<b>30</b>	<b>45</b>	<b>55</b>	<b>63</b>	<b>75</b>	<b>90</b>	<b>120</b>	<b>150</b>	<b>185</b>	<b>220</b>
kW	49	49	25	33	45	55	65	80	100	132	160	200	230
kW	49	49	30	34	48	55	67	85	100	132	160	200	230
kW	55	55	25	30	55	65	75	100	110	150	185	220	257
kW	55	55	25	30	55	65	75	100	110	150	185	220	257
kW	-	-	-	-	-	-	-	-	-	-	-	-	-
A	100	120	120	140	180	220	280	360	450	570	700	850	1000
A	55	70	85	100	130	160	200	300	360	460	550	660	800
A	112	144	120	140	180	220	280	360	450	570	700	850	1000
A	85	90	95	110	140	180	230	300	380	490	610	750	890
A	55	70	75	85	110	140	170	260	300	400	480	580	700
A	112	144	120	140	180	220	280	360	450	570	700	850	1000
A	55	70	75	85	110	140	170	260	300	400	480	580	700
A	100	120	100	120	160	200	250	320	400	500	600	700	800
	$\text{max. lamps per pole } (I_{rLED} \leq I_{rn}) = \frac{\text{inrush current of contactor}}{\text{inrush current of lamp/EVG}}$												
A	1551	1692	2115	2820	2961	3666	4512	6345	7755	9870	12126	14100	16920
A	69	75	100	120	160	190	220	260	315	440	500	560	630

# Contactors

## Data according to IEC 947-4-1, EN 60947-4-1, VDE 0660

Main Contacts		Type	K(G)3-10	K(G)3-14	K(G)3-18	K(G)3-22	K(G)3-24	K(G)3-32	K(G)3-40	K3-50	K3-62	K3-74
<b>Utilization category AC6a</b>												
<b>Transformer primary switching</b>												
at inrush		n	30	30	30	30	30	30	30	30	30	30
Rated operational current $I_e$	400V	A	4,5	5,5	7,5	7,5	10,5	13,5	13,5	20	27	33
Rated operational power	220-230V	kVA	1,8	2,2	3	3	4,2	5,4	5,4	8	10,7	13
dependent on inrush n	240V	kVA	1,9	2,3	3,1	3,1	4,3	5,6	5,6	8,3	11,2	13,5
	380-400V	kVA	3,1	3,8	5,2	5,2	7,3	9,3	9,3	13,5	18,5	22,5
For different inrush-factors x	415-440V	kVA	3,4	4,2	5,7	5,7	8	10,2	10,2	15	20,5	25
use the following formula:	500V	kVA	3,9	4,8	6,5	6,5	9	11,5	11,5	17	23	28
$P_x = P_n \cdot (n/x)$	660-690V	kVA	5,4	6,5	9	9	12,5	16	16	24	32	39
<b>Utilization category AC6b</b>												
<b>Switching of three-phase capacitors</b>												
Maximum inrush current (peak value)												
as multiple k of the												
capacitor rated current												
Rated operational current $I_e$	500V	k	35	25	20	20	25	25	25	25	25	20
		A	8	12	15,5	15,5	23	32	32	45	60	70
Rated operational current	220-230V	kVAr	3	4,5	6	6	8,5	12	12	17	24	28
( $\sin\phi=1$ )	240V	kVAr	3,5	5	6,5	6,5	9,5	13	13	18,5	25	29
	380-400V	kVAr	5	7,5	10	10	15	20	20	29	39	46
For different multiples x	415-440V	kVAr	5,5	8	11	11	16	22	22	32	43	50
use the following formula:	500V	kVAr	7	10	13	13	20	26	26	39	50	58
$P_x = P_k \cdot (k/x)$	660-690V	kVAr	7	10	13	13	20	26	26	40	50	58
<b>Switching of reactive capacitor banks</b>												
Rated operational current $I_e$	690V	A	8	13	18	20	28	36	42	48	72	108 <sup>1)</sup>
Rated operational power	220-230V	kVAr	2,9	5	7	7,5	11	14	16	20	28	33
	240V	kVAr	3,1	5,4	7	8	11	14	17	20	28	36
	380-400V	kVAr	5	9	12,5	13	20	25	27,5	33,3	50	75 <sup>1)</sup>
	415-440V	kVAr	5,5	9,5	13	14	22	27	30	36	53	75 <sup>1)</sup>
	500V	kVAr	6	11	15	17	25	30	36	40	60	75
	660-690V	kVAr	8	15	20	22	33	41	48	55	82	100
	1000V	kVAr	-	-	-	-	-	-	-	-	-	-
<b>Utilization category DC1</b>												
<b>Switching of resistive load</b>												
Time constant $L/R \leq 1\text{ms}$												
Rated operational current $I_e$	1 pole	24V - 60V	A	20	25	32	32	50	65	80	110	130
		110V	A	6	6	6	6	10	10	10	12	12
		220V	A	0,8	0,8	0,8	0,8	1,4	1,4	1,4	1,4	1,4
	2 poles in series	24V - 110V	A	20	25	32	32	50	65	80	110	130
		220V	A	6	6	6	6	10	10	10	12	12
	3 poles in series	24V - 110V	A	20	25	32	32	50	65	80	110	130
		220V	A	16	20	20	20	30	35	35	63	80
<b>Utilization category DC3 and DC5</b>												
<b>Switching of shunt motors and series motors</b>												
Time constant $L/R \leq 15\text{ms}$												
Rated operational current $I_e$	1 pole	24V	A	20	25	32	32	50	65	80	110	130
		60V	A	6	6	6	6	30	30	30	60	60
		110V	A	1,2	1,2	1,2	1,2	1,8	1,8	1,8	1,8	1,8
		220V	A	0,2	0,2	0,2	0,2	0,2	0,2	0,2	0,25	0,25
	2 poles in series	24V - 60V	A	20	25	32	32	50	65	80	110	130
		110V	A	6	6	6	6	30	30	30	60	60
		220V	A	1,2	1,2	1,2	1,2	1,8	1,8	1,8	1,8	1,8
	3 poles in series	24V	A	20	25	32	32	50	65	80	110	130
		60V	A	20	25	32	32	40	40	40	80	80
		110V	A	20	20	20	20	40	40	40	80	80
		220V	A	2,5	2,5	2,5	2,5	4	4	4	5	5

1) Consider resistive load ( $I_{th}$ ). see page 62



# Contactors

Data according to IEC 947-4-1, EN 60947-4-1, VDE 0660

Type	K3-90	K3-115	K3-151	K3-176	K3-210	K3-260	K3-316	K3-450	K3-550	K3-700	K3-860	K3-1000	K3-1200
n	30	30	30	30	30	30	30	30	30	30	30	30	30
A	38	50	65	80	90	120	142	203	248	315	390	450	540
kVA	15	20	25	30	34	45	54	77	95	120	148	170	200
kVA	15,5	20,5	27	33	37	50	59	80	100	130	160	185	220
kVA	26	34	45	55	60	80	95	140	170	210	270	310	370
kVA	29	38	46	57	63	85	100	145	175	220	280	320	380
kVA	33	43	55	69	75	100	120	170	210	270	330	380	460
kVA	45	60	56	69	100	135	160	200	250	320	350	500	600
k	20	20	20	20	25	20	20	20	20	20	20	20	20
A	87	100	120	155	195	225	255	300	370	440	520	680	760
kVAr	33	38	45	60	75	90	100	115	145	170	200	260	290
kVAr	36	42	52	62	78	94	104	120	150	175	205	270	300
kVAr	57	65	80	100	130	155	170	200	250	300	350	450	500
kVAr	60	70	95	110	135	165	175	210	260	310	360	465	520
kVAr	70	80	100	130	170	194	220	260	320	380	450	590	660
kVAr	70	80	100	130	170	194	220	260	320	380	450	590	660
A	115	144	115	140	200	225	250	330	420	550	600	680	760
kVAr	45	55	43	53	76	85	95	125	160	209	228	260	290
kVAr	45	55	45	55	80	90	100	130	170	220	240	280	310
kVAr	80	100	75	90	130	145	160	210	270	350	390	440	480
kVAr	100	120	80	100	140	160	170	230	290	380	420	470	530
kVAr	105	125	95	120	170	190	210	280	350	450	500	570	640
kVAr	120	148	125	150	200	230	260	350	450	600	650	700	800
kVAr	150	180	155	200	300	340	400	500	650	-	-	-	-
A	160	200	-	-	-	-	-	-	-	-	-	-	-
A	20	25	-	-	-	-	-	-	-	-	-	-	-
A	2	2,5	-	-	-	-	-	-	-	-	-	-	-
A	160	200	-	-	-	-	-	-	-	-	-	-	-
A	20	25	-	-	-	-	-	-	-	-	-	-	-
A	160	200	150	170	250	280	315	400	480	560	630	800	900
A	100	160	80	100	150	180	200	250	315	400	450	500	600
A	160	200	-	-	-	-	-	-	-	-	-	-	-
A	85	110	-	-	-	-	-	-	-	-	-	-	-
A	2	2,5	-	-	-	-	-	-	-	-	-	-	-
A	0,5	0,5	-	-	-	-	-	-	-	-	-	-	-
A	160	200	-	-	-	-	-	-	-	-	-	-	-
A	85	110	-	-	-	-	-	-	-	-	-	-	-
A	2	2,5	-	-	-	-	-	-	-	-	-	-	-
A	160	200	-	-	-	-	-	-	-	-	-	-	-
A	100	110	-	-	-	-	-	-	-	-	-	-	-
A	100	110	-	-	-	-	-	-	-	-	-	-	-
A	7	8	-	-	-	-	-	-	-	-	-	-	-

# Contactors







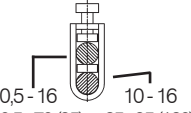

## Data according to IEC 947-4-1, EN 60947-4-1, VDE 0660

Main Contacts			Type	K(G)3-10	K(G)3-14	K(G)3-18	K(G)3-22	K(G)3-24	K(G)3-32	K(G)3-40	K3-50	K3-62	K3-74		
<b>Maximum ambient temperature</b>															
Operation	open	°C	-40 to +60 (+90) <sup>1)</sup>												
	enclosed	°C	-40 to +40												
with thermal overload relay	open	°C	-25 to +60												
enclosed		°C	-25 to +40												
Storage		°C	-50 to +90												
<b>Short circuit protection</b> without O/L relay															
Rated short circuit current	"r" / "Ic"	kA	10	10	10	10	10	10	10	10	10	10	10		
Coordination-type "1" according to IEC 947-4-1 Contact welding without hazard of persons max. fuse size				gL (gG)	A	63	63	63	63	100	100	100	160	160	160
Coordination-type "2" according to IEC 947-4-1 Light contact welding accepted max. fuse size				gL (gG)	A	25	35	35	35	50	50	50	100	125	125
Contact welding not accepted max. fuse size For contactors with thermal overload relay the device with the smaller admissible backup fuse (contactor or thermal overload relay) determines the fuse size.				gL (gG)	A	16	16	16	16	25	35	35	50	63	63
<b>Cable cross-sections</b> for contactors without thermal overload relay 1 cable per clamp															
main connector	solid or stranded	mm <sup>2</sup>													
		flexible	mm <sup>2</sup>	0,75 - 6			1,5 - 25			4 - 50					
		flexible with multicore cable end	mm <sup>2</sup>	1 - 4			2,5 - 16			10 - 35					
			0,75 - 4			1,5 - 16			6 - 35						
2 cables per clamp															
	solid or stranded	mm <sup>2</sup>	6+(1-6) / 4+(0,75-4)			16+(2,5-16) / 10+(4-16)			50+4 / 35+6 / 25+(6-16)						
		flexible	mm <sup>2</sup>	2,5+(0,75-2,5) / 1,5+(0,75-1,5)			6+(4-16) / 4+(2,5-16)			16+(6-16) / 10+(6-16)					
			6+(1,5-4) / 4+(1-4)			16+(2,5-6) / 10+(4-10)			50+(4-10) / 35+(4-16)						
			2,5+(0,75-2,5) / 1,5+(0,75-1,5)			6+(4-16) / 4+(2,5-16)			25+(4-25) / 16+(4-16)						
1 cable per clamp main connector															
	solid	AWG	18 - 10			16 - 10			12 - 10						
		flexible	AWG	18 - 10			14 - 4			10 - 0					
2 cables per clamp															
	solid	AWG	10+(16-10) / 12+(18-12)			10+(16-10) / 12+(18-12)			10+(12-10) / 12+12						
		flexible	AWG	14+(18-14) / 16+(18-16)			14+(18-14) / 16+(18-16)			4+(18-12) / 6+(18-8)					
			10+(14-10) / 12+(18-12)			8+(18-8) / 10+(18-12)			1+(12-10) / 2+(8-12)						
			14+(18-14) / 16+(18-16)			3+(12-8) / 4+(10-6)									
<b>Frequency of operations z</b> Contactors without thermal overload relay															
		without load	1/h	10000			7000			7000					
		AC3, I <sub>e</sub>	1/h	600			600			400					
		AC4, I <sub>e</sub>	1/h	120			120			120					
		DC3, I <sub>e</sub>	1/h	600			600			400					
<b>Mechanical life</b>															
AC operated		S x 10 <sup>6</sup>		10			10			10					
DC operated		S x 10 <sup>6</sup>		10			10			10					
DC-solenoid operated (KG3)		S x 10 <sup>6</sup>		50			50			-					
<b>Short time current</b>															
10s-current		A	96	120	144	176	184	240	296	450	504	592			
120s-current		A	42	52	58	66	80	97	110	195	203	222			
<b>Power loss per pole</b> contact resistance															
at I <sub>e</sub> /AC3 400V		W	0,21	0,35	0,5	0,75	0,7	1,3	2	2,2	3,9	5,5			
		mOhm	2,1	1,8	1,5	1,5	1,2	1,2	1,2	1	1	1			
<b>Resistance to shock acc. to IEC 60068-2-27</b>															
Shock time 20ms sine-wave		NO	g	10	10	10	10	8	8	8	8	8			
		NC	g	6	6	6	6	-	-	-	-	-			

1) With reduced control voltage range 0,9 up to 1,0 x U<sub>s</sub> and with reduced rated current I<sub>e</sub>/AC1, no deratings for I<sub>e</sub>/AC3 values.

# Contactors

Data according to IEC 947-4-1, EN 60947-4-1, VDE 0660

Type	K3-90	K3-115	K3-116	K3-151	K3-176	K3-210	K3-260	K3-316	K3-450	K3-550	K3-700	K3-860	K3-1000	K3-1200
°C	-40 bis +60 (+90) <sup>1)</sup>													
°C	-40 to +40													
°C	-25 to +60													
°C	-25 to +40													
°C	-50 to +90													
°C			-25 to +55 (+70) <sup>2)</sup>											
°C			-25 to +40											
°C			-25 to +55											
°C			-25 to +40											
°C			-55 to +80											
kA	10	10	10	10	10	10	10	10	18	18	30	30	30	42
A	250	250	200	250	315	400	450	500	630	630	800	1000	1000	1250
A	160	200	160	200	250	315	400	400	500	560	-	-	-	-
A	100	125	125	160	200	250	315	-	-	-	-	-	-	-
mm <sup>2</sup>														
mm <sup>2</sup>	0,5-16	10-16	busbar 18 x 4		busbar 25 x 6		busbar 40 x 5		busbar 50 x 5	busbar 50 x 8	busbar 50 x 8	busbar 50 x 8	busbar 50 x 10	
mm <sup>2</sup>	0,5-70 (95)	25-95 (120)	screw M8		screw M10		screw M10		screw M12	screw M12	screw M12	screw M14	screw 2 x M12	
mm <sup>2</sup>	0,5-70	10-95												
mm <sup>2</sup>	0,5 - 95 + 10 - 120													
mm <sup>2</sup>	0,5 - 70 + 25 - 95													
mm <sup>2</sup>														
AWG	18 - 10	-												
AWG	18 - 3/0	8 - 4/0												
AWG	-	-												
AWG	18 - 3/0 + 8 - 4/0													
1/h	3000		1200		1200		1200			1200			300	
1/h	300		240		150		50			25			20	
1/h	120		-		-		-			-			-	
1/h	300		-		-		-			-			-	
S x 10 <sup>6</sup>	5		10		5		5			5			5 <sup>3)</sup>	
S x 10 <sup>6</sup>	5		10		5		5			5			5 <sup>3)</sup>	
S x 10 <sup>6</sup>	-		-		-		-			-			-	
A	680	880	920	1200	1400	1800	2200	2600	3600	4400	5600	6900	8000	9600
A	275	330	410	500	575	800	900	1000	1400	1750	2200	2600	3000	3600
W	4,8	7,9	7,9	9	11	8	11	14,9	26,3	33,3	49	59,2	60	72
mOhm	0,6	0,5	0,5	0,4	0,35	0,18	0,16	0,15						
g	7	7	-	-	-	-	-	-	-	-	-	-	-	-
g	5	5	-	-	-	-	-	-	-	-	-	-	-	-

1) With reduced control voltage range 0,9 up to 1,0 x U<sub>s</sub> and with reduced rated current I<sub>b</sub>/AC1, no deratings for I<sub>b</sub>/AC3 values.

2) With reduced control voltage range 1,0 x U<sub>s</sub> and with reduced rated current I<sub>b</sub>/AC1 no deratings for I<sub>b</sub>/AC3 values.

3) After each 1x10<sup>6</sup> operations magnetic core and built-in auxiliary contact block must be changed.

# Contactors

## Data according to IEC 947-4-1, EN 60947-4-1, VDE 0660

Auxiliary Contacts			Type	K(G)3-10	K(G)3-14	K(G)3-18	K(G)3-22	K(G)3-24	K(G)3-32	K(G)3-40	K3-50	K3-62	K3-74	
<b>Rated insulation voltage <math>U_i</math> <sup>1)</sup></b>			V~	690				-		-				
<b>Thermal rated current <math>I_{th}</math> to 690V</b>														
Ambient temperature			40°C A	10				(16) <sup>5)</sup>		-				
			60°C A	6				(12) <sup>5)</sup>		-				
<b>Utilization category AC15</b>														
Rated operational current $I_e$			220-240V A	3				(12) <sup>5)</sup>		-				
			380-415V A	2				(4) <sup>5)</sup>		-				
			440V A	1,6				(4) <sup>5)</sup>		-				
			500V A	1,2				(3) <sup>5)</sup>		-				
			660-690V A	0,6				(1) <sup>5)</sup>		-				
<b>Utilization category DC13</b>														
Rated operational current $I_e$			60V A	3,5				(8) <sup>5)</sup>		-				
			110V A	0,5				(1) <sup>5)</sup>		-				
			220V A	0,1						-				
<b>Short circuit protection</b>			For contactors with thermal overload relay the device with the smaller admissible control fuse (contactor or thermal overload relay) determines the fuse.											
short-circuit current 1kA, contact welding not accepted max. fuse size			gL (gG) A	20				(25) <sup>5)</sup>		-		-		
<b>Control Circuit</b>														
<b>Power consumption of coils</b>														
AC operated			inrush VA	33-45				90-115		140-165				
			sealed VA	7-10				9-13		13-18				
			W	2,6-3				2,7-4		5,4-7				
DC operated			inrush W	75				140		200				
double winding coil			sealed W	2				2		6				
DC solenoid operated (KG3)			inrush W	3				4		-				
			sealed W	3				4		-				
<b>Operation range of coils</b>														
in multiples of control voltage $U_c$			AC operated	0,85-1,1				0,85-1,1		0,85-1,1				
			DC operated	0,8-1,1				0,8-1,1		0,8-1,1				
<b>Switching time</b> at control voltage $U_c \pm 10\%$ <sup>2) 3)</sup>														
AC operated			make time ms	8-16				10-25		12-28				
			release time ms	5-13				8-15		8-15				
			arc duration ms	10-15				10-15		10-15				
DC operated			make time ms	8-12				10-20		12-23				
double winding coil			release time ms	8-13				10-15		10-18				
			arc duration ms	10-15				10-15		10-15				
DC solenoid operated (KG3)			make time ms	65 - 85				65 - 85		-				
			release time ms	20 - 30 <sup>4)</sup>				20 - 30 <sup>4)</sup>		-				
			arc duration ms	10-15				10-15		-				
<b>Cable cross-section</b>														
Auxiliary connector			solid mm <sup>2</sup>	0,75-6				-		-				
			flexible mm <sup>2</sup>	1-4				-		-				
			flexible with multicore cable end mm <sup>2</sup>	0,75-4				-		-				
Magnet coil			solid mm <sup>2</sup>	0,75-2,5				0,75-2,5		0,75-2,5				
			flexible mm <sup>2</sup>	0,5-2,5				0,5-2,5		0,5-2,5				
			flexible with multicore cable end mm <sup>2</sup>	0,5-1,5				0,5-1,5		0,5-1,5				
Clamps per pole				2				2		2				
Auxiliary connector			solid AWG	18 - 10				-		-				
			flexible AWG	18 - 10				-		-				
Magnet coil			solid AWG	14 - 12				14 - 12		14 - 12				
			flexible AWG	18 - 12				18 - 12		18 - 12				
Clamps per pole				2				2		2				

1) Suitable for: earthed-neutral systems, overvoltage category I to IV, pollution degree 3 (standard-industry):  $U_{imp} = 8kV$ . Data for other conditions on request

2) Total breaking time = release time + arc duration

3) Values for delay of the release time of the make contact and the make time of the break contact will be increased, if magnet coils are protected against voltage peaks (varistor, RC-unit, diode-unit)

4) with built-in coil suppressor 5) for contactors KG3-...A.. only

# Contactors

Data according to IEC 947-4-1, EN 60947-4-1, VDE 0660

Type	K3-90 <sup>1)</sup>	K3-115 <sup>1)</sup>	K3-116	K3-151	K3-176	K3-210	K3-260	K3-316	K3-450	K3-550	K3-700	K3-860	K3-1000	K3-1200
V~	-	-	-	-	-	-	-	-	690	-	690	-	690	-
A	-	-	-	-	-	-	-	-	10	-	10	-	10	-
A	-	-	-	-	-	-	-	-	-	-	-	-	-	-
-	-	-	-	-	-	-	-	-	-	-	-	-	-	-
A	-	-	-	-	-	-	-	-	3	-	3	-	3	-
A	-	-	-	-	-	-	-	-	2	-	2	-	2	-
A	-	-	-	-	-	-	-	-	1,5	-	1,5	-	1,5	-
A	-	-	-	-	-	-	-	-	1,5	-	1,5	-	1,5	-
A	-	-	-	-	-	-	-	-	1	-	1	-	1	-
A	-	-	-	-	-	-	-	-	-	-	-	-	-	-
A	-	-	-	-	-	-	-	-	1	-	1	-	1	-
A	-	-	-	-	-	-	-	-	0,5	-	0,5	-	0,5	-
A	-	-	-	-	-	-	-	-	-	-	-	-	-	-
A	-	-	-	-	-	-	-	-	10	-	10	-	10	-
VA	165-220	-	-	350	-	-	360	-	800-950	-	1350-1600	-	2400	-
VA	2,5-5	-	-	5	-	-	5	-	9-11	-	21-25	-	70	-
W	2,5-5	-	-	5	-	-	5	-	9-11	-	21-25	-	70	-
W	250	-	-	350	-	-	360	-	700-850	-	1300-1550	-	2100	-
W	5	-	-	5	-	-	5	-	8-10	-	18-22	-	60	-
W	-	-	-	-	-	-	-	-	-	-	-	-	-	-
W	-	-	-	-	-	-	-	-	-	-	-	-	-	-
ms	0,85-1,1 0,8-1,1	-	-	0,85-1,1 0,85-1,1	-	-	0,85-1,1 0,85-1,1	-	0,85-1,1 0,85-1,1	-	0,85-1,1 0,85-1,1	-	0,85-1,1 0,85-1,1	-
ms	20-35	-	-	30-60	-	-	40-60	-	50-100	-	50-100	-	50-100	-
ms	35-50	-	-	30-80	-	-	15-45	-	150-200 / 500-1000 <sup>2)</sup>	-	25-50	-	25-50	-
ms	10-15	-	-	-	-	-	-	-	-	-	-	-	-	-
ms	20-35	-	-	30-60	-	-	40-60	-	-	-	-	-	-	-
ms	35-50	-	-	30-80	-	-	15-45	-	-	-	-	-	-	-
ms	10-15	-	-	-	-	-	-	-	-	-	-	-	-	-
ms	-	-	-	-	-	-	-	-	-	-	-	-	-	-
ms	-	-	-	-	-	-	-	-	-	-	-	-	-	-
ms	-	-	-	-	-	-	-	-	-	-	-	-	-	-
mm <sup>2</sup>	-	-	-	-	-	-	-	-	0,75-2,5	-	0,75-2,5	-	0,75-2,5	-
mm <sup>2</sup>	-	-	-	-	-	-	-	-	0,75-2,5	-	0,75-2,5	-	0,75-2,5	-
mm <sup>2</sup>	-	-	-	-	-	-	-	-	-	-	-	-	-	-
mm <sup>2</sup>	0,75-2,5	-	-	1-2,5	-	-	1-2,5	-	1-2,5	-	1-2,5	-	1-2,5	-
mm <sup>2</sup>	0,5-2,5	-	-	1-2,5	-	-	1-2,5	-	1-2,5	-	1-2,5	-	1-2,5	-
mm <sup>2</sup>	0,5-1,5	-	-	-	-	-	-	-	-	-	-	-	-	-
mm <sup>2</sup>	2	-	-	2	-	-	2	-	2	-	2	-	2	-
AWG	-	-	-	-	-	-	-	-	16 - 12	-	16 - 12	-	16 - 12	-
AWG	-	-	-	-	-	-	-	-	16 - 12	-	16 - 12	-	16 - 12	-
AWG	14 - 12	-	-	16 - 12	-	-	16 - 12	-	16 - 12	-	16 - 12	-	16 - 12	-
AWG	18 - 12	-	-	16 - 12	-	-	16 - 12	-	16 - 12	-	16 - 12	-	16 - 12	-
	2	-	-	2	-	-	2	-	2	-	2	-	2	-

1) Coil ≤ 230/500 ... U<sub>i</sub>=250/550V U<sub>inc</sub> = 1,5kV

2) Normal or delayed drop is adjustable

# Contactors for North America

## Data according to UL508

Main Contacts (cULus)		Type	K(G)3-10	K(G)3-14	K(G)3-18	K(G)3-22	K(G)3-24	K(G)3-32	K(G)3-40	K3-50	K3-62	K3-74
Rated operational current "General Use"	NO	A	25	25	30	30	50	65	80	110	120	130
	NC	A	25	25	30	30	40	50	65	-	-	-
<b>Motor DOL 3-phase</b> at 60Hz												
Rated operational power	110-120V	hp	1½	2	2	3	5	5	7½	10	10	10
	200V	hp	3	3	5	5	7½	10	10	15	20	25
	220-240V	hp	3	3	7½	7½	10	10	15	20	25	30
	277V	hp	3	5	7½	7½	7½	10	15	20	25	30
	380-415V	hp	5	5	10	10	10	15	20	25	30	40
	440-480V	hp	5	7½	10	15	15	20	25	30	40	50
	550-600V	hp	7½	10	15	20	20	25	30	40	50	50
<b>Motor DOL 1-phase</b> (2-pole break) at 60Hz												
Rated operational power of AC motors at 60Hz (1ph)	110-120V	hp	½	¾	1	1½	1½	2	3	3	5	7½
	200V	hp	1	1,5	2	3	3	5	7½	7½	10	15
	220-240V	hp	1½	2	3	3	5	5	7½	10	15	15
	277V	hp	2	3	3	5	5	7½	10	10	15	15
	380-415V	hp	3	3	5	5	5	7½	10	15	20	20
	440-480V	hp	3	5	5	7½	7½	10	15	20	25	25
	550-600V	hp	3	5	7½	10	10	15	20	25	30	30
<b>Motor DOL 3-phase</b> according to <b>ASME A17.5</b>												
Rated operational current	600V	A	-	-	-	-	15	22	-	27	37	-
Rated operational power of 3-phase motors for elevators (500.000 operations)	110-120V	hp	-	-	-	-	2	3	-	3	5	-
	200V	hp	-	-	-	-	3	5	-	7½	10	-
	220-240V	hp	-	-	-	-	5	7½	-	7½	10	-
	440-480V	hp	-	-	-	-	10	15	-	20	25	-
	550-600V	hp	-	-	-	-	10	20	-	25	30	-
Rated current 2 series contacts	600V	A	-	-	-	20,5	22	27	34	44	52	60
Fuse Class RK5 / Short-circuit current		A/kA	50/5	50/5	70/5	90/5	90/5	125/5	175/5	200/5	250/5	300/5
Fuse Class T / Short-circuit current		A/kA	45/100	50/100	70/100	90/100	110/100	150/100	150/100	175/100	175/100	175/100
Rated voltage		V	600	600	600	600	600	600	600	600	600	600
<b>Auxiliary Contacts (cULus)</b>			A600	A600	A600	A600	-	-	-	-	-	-

# Contactors for North America

## Data according to UL508

Type	K3-90	K3-115	K3-116	K3-151	K3-176	K3-210	K3-260	K3-316	K3-450	K3-550	K3-700	K3-860	K3-1000	K3-1200
A	160	200	150	180	220	250	300	350	420	520	700	810	-	1215
A	-	-	-	-	-	-	-	-	-	-	-	-	-	-
hp	15	20	-	-	-	-	-	-	-	-	-	-	-	-
hp	25	35	30	40	50	60	75	100	125	150	200	250	-	450
hp	35	40	40	50	60	75	100	125	125	150	250	300	-	450
hp	-	-	-	-	-	-	-	-	-	-	-	-	-	-
hp	50	60	-	-	-	-	-	-	-	-	-	-	-	-
hp	65	75	75	100	125	150	200	250	250	350	500	600	-	900
hp	85	100	100	125	150	200	250	300	250	350	500	600	-	900
hp	8	10	10	15	25	-	-	-	-	-	-	-	-	-
hp	15	20	20	-	-	-	-	-	-	-	-	-	-	-
hp	20	25	-	25	30	40	50	50	-	-	-	-	-	-
hp	20	25	-	-	-	-	-	-	-	-	-	-	-	-
hp	30	40	-	-	-	-	-	-	-	-	-	-	-	-
hp	40	50	-	-	-	-	-	-	-	-	-	-	-	-
hp	50	60	-	-	-	-	-	-	-	-	-	-	-	-
A	-	-	-	-	-	-	-	-	-	-	-	-	-	-
hp	-	-	-	-	-	-	-	-	-	-	-	-	-	-
hp	-	-	-	-	-	-	-	-	-	-	-	-	-	-
hp	-	-	-	-	-	-	-	-	-	-	-	-	-	-
hp	-	-	-	-	-	-	-	-	-	-	-	-	-	-
A	-	-	-	-	-	-	-	-	-	-	-	-	-	-
A/kA	300/10	300/10	225/10	300/10	350/10	400/18	500/18	500/18	1200/18	1200/18	2000/30	2000/30	-	2000/42
A/kA	300/100 <sup>3)</sup>	300/100 <sup>3)</sup>	-	-	-	-	-	-	-	-	-	-	-	-
V	600	600	600	600	600	600	600	600	600	600	600	600	600	600
	-	-	-	-	-	-	-	-	A600	A600	A600	A600	-	A600

Main Contacts (cULus)	Type	K3-18NK	K3-18NBK	K3-24K	K3-32K	K3-50K	K3-62K	K3-74K	K3-90K	K3-115K	
Rated operational power of 3-phase cap. banks 110-120V at 60Hz (3ph)	200V	kVAr	0-3,5	0-3,5	3-5,5	3-7	6,5-10	6,5-15	6,5-18 <sup>1)</sup>	10-24	10-28 <sup>2)</sup>
	220-240V	kVAr	0-6	0-6	4,5-10	4,5-12,5	10-16,7	10-25	10-32 <sup>1)</sup>	17-40	17-46 <sup>2)</sup>
		kVAr	0-7	0-7	5,5-11	5,5-15	12,5-20	12,5-30	12,5-36 <sup>1)</sup>	20-47	20-56 <sup>2)</sup>
	440-480V	kVAr	0-15	0-15	11,5-25	11,5-30	25-40	25-60	25-72 <sup>1)</sup>	40-95	40-114 <sup>2)</sup>
550-600V	kVAr	0-18	0-18	14,5-30	14,5-35	31-50	31-75	31-90 <sup>1)</sup>	50-120	50-143 <sup>2)</sup>	
Fuse Class RK5 / Short-circuit current	A/kA	70/5	70/5	90/5	125/5	200/5	250/5	300/5	300/10	300/10	
Fuse Class T / Short-circuit current	A/kA	80/100	80/100	110/100	150/100	175/100	175/100	175/100	300/100 <sup>3)</sup>	300/100 <sup>3)</sup>	
Rated voltage	V	600	600	600	600	600	600	600	600	600	
<b>Auxiliary Contacts (cULus)</b>		A600	A600	-	-	-	-	-	-	-	

1) Consider the max. thermal current of the contactor K3-74A: I<sub>th</sub> 130A

2) Consider the min. cross-section of conductor at max. load

3) Class T and Class RK1

# Contactors

## Data according to IEC 947-4-1, EN 60947-4-1, VDE 0660

### Contact Life

For selection of the suitable contactor-type according to supply voltage, power rating and application (utilization category AC1, AC3 or AC4) use contact life characteristic diagram.

For the most common supply voltages four scales of power ratings  $P_n$  are provided for each utilization category.

Select contactor-type according to utilization category **AC3** (breaking current  $I_a = I_e$ ) using the **motor rating** scales to the right, according to utilization category **AC4** (breaking current  $I_a = 6 \times I_e$ ) using the **motor rating** scales to the left. <sup>1)</sup>

Select contactor-type according to utilization category **AC1** (breaking current  $I_a = I_e/AC1$ ) using the **breaking current** scale. <sup>1)</sup>

For contactors frequently used under AC3/AC4-mixed service conditions calculate contact life with the formula:

$$M = \frac{AC3}{1 + \frac{\%AC4}{100} \times \left( \frac{AC3}{AC4} - 1 \right)}$$

M = Contact life (switching cycles) for AC3/AC4-mixed operations  
 AC3 = Contact life (switching cycles) for AC3 operations (normal switching conditions). Breaking current  $I_a =$  rated motor current  $I_e$ .  
 AC4 = Contact life (switching cycles) for AC4 operations (inching). Breaking current  $I_a =$  multiples of rated motor current  $I_e$ .  
 %AC4 = Percents of AC4-operations related to the total cycles.

#### Motor Rating

##### $P_n = AC4$

660/ 500V 380/ 220/  
690V 400V 230V

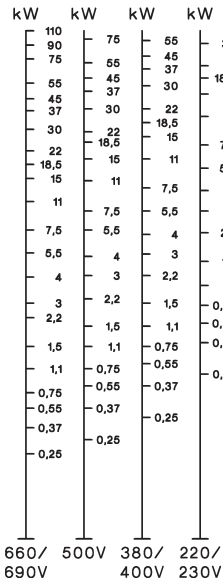

#### Motor Rating

##### $P_n = AC3$

660/ 500V 380/ 220/  
690V 400V 230V

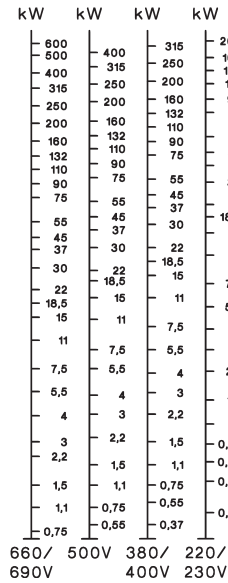

#### Breaking Current

##### $I_a (= I_e = AC1)$

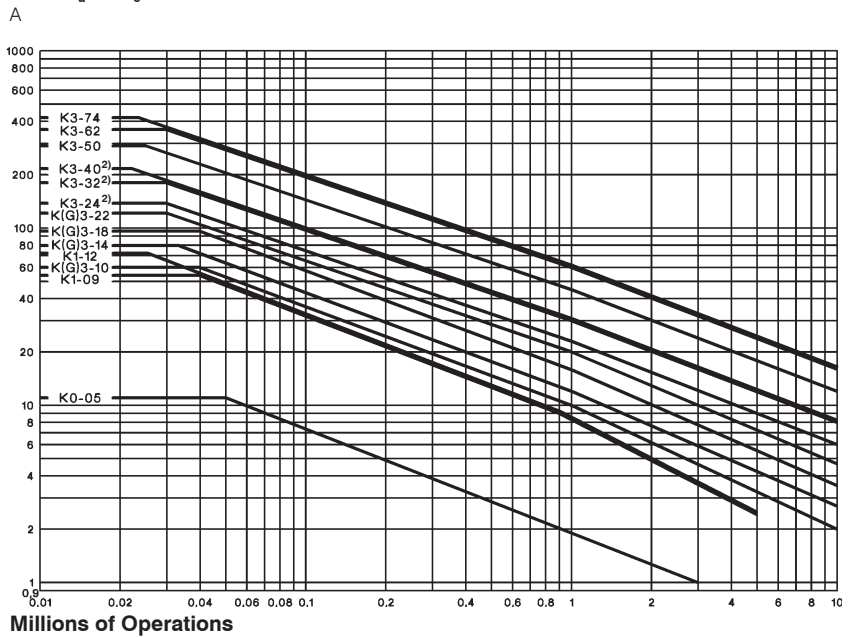

#### Motor Rating

##### $P_n = AC4$

660/ 500V 380/ 220/  
690V 400V 230V

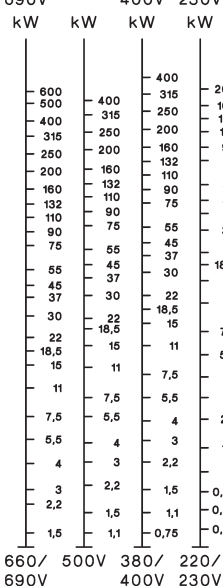

#### Motor Rating

##### $P_n = AC3$

660/ 500V 380/ 220/  
690V 400V 230V

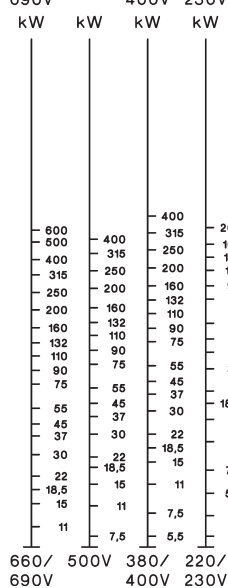

#### Breaking Current

##### $I_a (= I_e = AC1)$

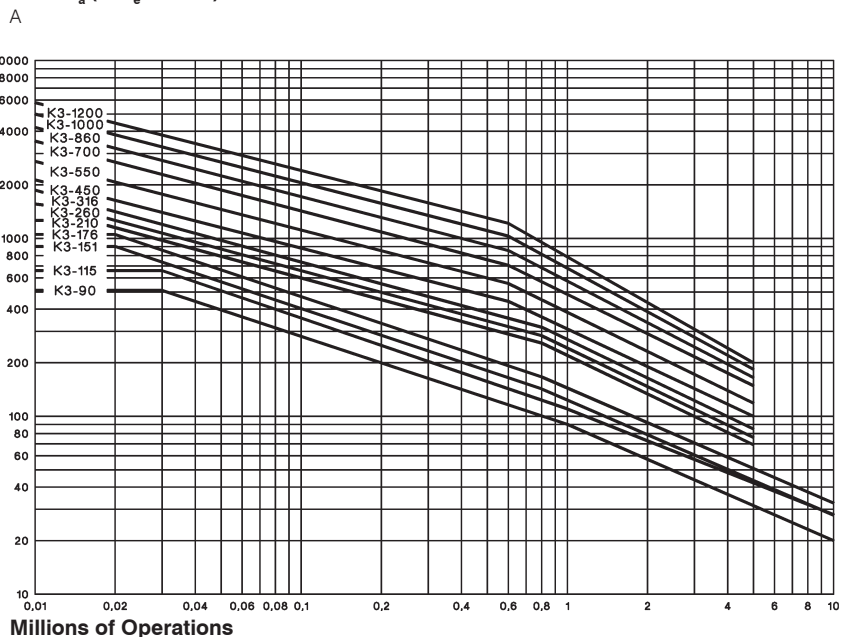

1) Pay attention to the approved rated values of the selected contactor according to the national approvals.

2) Valid for NO contacts. NC contacts minus 50 %.

# Contactors

## Utilization Categories

For easier choice of devices and in order to make the comparison of different products simpler are utilization categories for contactors and motor-starters according to IEC 947-4-1 and VDE 0660 Part

102, for control circuit devices and switching elements according to IEC 947-5-1 and VDE 0660 Part 200 determined. The table offers different utilization categories, typical applications and assorted test conditions.

Type of current	Category	Typical applications	Rated operational current	Test conditions for the number of on-load operating cycles						Test conditions for making and breaking capacities					
				Make			Break			Make			Break		
				$I/I_e$	$U/U_e$	cosφ	$I_c/I_e$	$U_c/U_e$	cosφ	$I/I_e$	$U/U_e$	cosφ	$I_c/I_e$	$U_c/U_e$	cosφ
Alternating Current	<b>AC1</b>	Non-inductive or slightly inductive loads resistance furnaces	all values	1	1	0,95	1	1	0,95	1,5	1,05	0,8	1,5	1,05	0,8
	<b>AC2</b>	Slip-ring motors: starting, switching off	all values	2,5	1	0,65	2,5	1	0,65	4	1,05	0,65	4	1,05	0,65
	<b>AC3</b>	Squirrel-cage motors: starting, switching off motors during running	$I_e < 17A$ $I_e > 17A$ $I_e > 100A$	6 6 6	1 1 1	0,65 0,35 0,35	1 1 1	0,17 0,17 0,17	0,65 0,35 0,35	10 10 10	1,05 1,05 1,05	0,45 0,45 0,35	8 8 8	1,05 1,05 1,05	0,45 0,45 0,35
	<b>AC4</b>	Squirrel-cage motors: starting, plugging, inching	$I_e < 17A$ $I_e > 17A$ $I_e > 100A$	6 6 6	1 1 1	0,65 0,35 0,35	6 6 6	1 1 1	0,65 0,35 0,35	12 12 12	1,05 1,05 1,05	0,45 0,45 0,35	10 10 10	1,05 1,05 1,05	0,45 0,45 0,35
	<b>AC5a</b>	Switching of electric discharge lamp controls	all values	-	-	-	-	-	-	3	1,05	0,45	3	1,05	0,45
	<b>AC5b</b>	Switching of incandescent lamps	all values	-	-	-	-	-	-	1,5	1,05	<sup>1)</sup>	4	1,05	<sup>1)</sup>
	<b>AC6a</b>	Switching of transformers	$I_e < 100A$ $I_e > 100A$	-	-	-	-	-	-	4,5 4,5	1,05 1,05	0,45 0,35	3,6 3,6	1,05 1,05	0,45 0,35
	<b>AC6b</b>	Switching of capacitors	-	-	-	-	-	-	-	<sup>2)</sup>			<sup>2)</sup>		
	<b>AC7a</b>	Slightly inductive loads in household appliances and similar applications	all values	-	-	-	-	-	-	1,5	1,05	0,8	1,5	1,05	0,8
	<b>AC7b</b>	Motor loads for household applications	$I_e < 100A$ $I_e > 100A$	-	-	-	-	-	-	8 8	1,05 1,05	0,45 0,35	6 6	1,05 1,05	0,45 0,35
	<b>AC8a</b>	Hermetic refrigerant compressor motor control with manual resetting of overload releases	$I_e < 100A$ $I_e > 100A$	-	-	-	-	-	-	6 6	1,05 1,05	0,45 0,35	6 6	1,05 1,05	0,45 0,35
	<b>AC8b</b>	Hermetic refrigerant compressor motor control with automatic resetting of overload releases	$I_e < 100A$ $I_e > 100A$	-	-	-	-	-	-	6 6	1,05 1,05	0,45 0,35	6 6	1,05 1,05	0,45 0,35
	<b>AC12</b>	Control of resistive loads and solid state loads with isolation by opto couplers	all values	-	-	-	-	-	-	1	1	0,9	1	1	0,9
	<b>AC13</b>	Control of solid state loads with transformer isolation	all values	-	-	-	-	-	-	10	1,1	0,65	1,1	1,1	0,65
	<b>AC14</b>	Control of small electromagnetic loads ( $\leq 72VA$ )	-	-	-	-	-	-	-	6	1,1	0,7	6	1,1	0,7
<b>AC15</b>	Control of electromagnetic load ( $> 72VA$ )	-	10	1	0,7	1	1	0,4	10	1,1	0,3	10	1,1	0,3	
Direct Current	<b>DC1</b>	Non-inductive or slightly inductive loads resistance furnaces	all values	1	1	1	1	1	1	1,5	1,05	1	1,5	1,05	1
	<b>DC3</b>	Shunt-motors: starting, plugging, inching dynamic braking of d.c. motors	all values	2,5	1	2	2,5	1	2	4	1,05	2,5	4	1,05	2,5
	<b>DC5</b>	Series-motors: starting, plugging, inching dynamic braking of d.c. motors	all values	2,5	1	7,5	2,5	1	7,5	4	1,05	15	4	1,05	15
	<b>DC6</b>	Switching of incandescent lamps	all values	-	-	-	-	-	-	1,5	1,05	<sup>1)</sup>	4	1,05	<sup>1)</sup>
	<b>DC12</b>	Control of resistive loads and solid state loads with isolation by opto couplers	all values	-	-	-	-	-	-	1	1	1	1	1	1
	<b>DC13</b>	Control of electromagnets	all values	1	1	$\leq 300$	1	1	$\leq 300$	1,1	1,1	$\leq 300$	1,1	1,1	$\leq 300$
	<b>DC14</b>	Control of electromagnetic loads having economy resistors in circuit	all values	-	-	-	-	-	-	10	1,1	15	10	1,1	15

$U_e$  Rated operational voltage,  $U$  Voltage before make,  $U_r$  Recovery voltage,  $I_e$  Rated operational current,  $I$  Current make,  $I_c$  Current broken

1) Test with incandescent lamps

2) Test conditions according to standard

## Accessories

### Data according to IEC 947-5-1, EN 60947-5-1, VDE 0660

Type		HN	HTN	HA	HB	HKT	HKA	HKF HKB	K2-DK K2-SK	K2-L <sup>2)</sup>
<b>Rated insulation voltage</b> $U_i$ <sup>1)</sup>	V AC	690	690	690	690	690	690	690	690	690
<b>Thermal rated current</b> $I_{th}$ to bis 690V										
Ambient temperature	max. 40°C A	10	10	25	10	10	10	16	26	10
	max. 60°C A	6	6	20	6	-	-	-	-	6
<b>Frequency of operations z</b>	1/h	3000	-	3000	3000	-	-	-	-	3000
<b>Mechanical life</b>	$S \times 10^6$	10	10	10	10	-	-	-	-	10
<b>Power loss</b> per pole at $I_n/AC1$	W	0,5	0,5	1,5	0,5	-	-	-	-	-
<b>Utilization category AC15</b>										
Rated operational current $I_e$	220-240V A	3	3	6	3	3	3	3	-	3
	380-400V A	2	2	3	2	2	2	2	-	2
	440V A	1,6	1,6	2	1,6	1,5	1,5	1,5	-	1,6
	500V A	1,2	1,2	2	1,2	1,5	1,5	1,5	-	1
	660-690V A	0,6	0,6	1	0,6	1	1	1	-	0,5
<b>Utilization category DC13</b>										
Rated operational current $I_e$	24V A	2	2	8	2	5	4	6	-	2
	48V A	2	2	8	2	2	1,5	3	-	2
	60V A	2	2	8	2	-	-	-	-	2
	110V A	0,4	0,4	1	0,4	0,8	0,5	1	-	0,4
	220V A	0,1	0,1	0,1	0,1	0,4	0,2	0,5	-	0,1
<b>Short circuit protection</b> short-circuit current 1kA, contact welding not accepted max. fuse size	gL (gG) A	20	20	25	20	10	10	10	-	10
For contactors with thermal overload relay or auxiliary contacts the device with the smaller admissible control fuse (contactor or thermal overload relay) determines the fuse size.										
<b>Cable cross-sections</b>										
solid or stranded	mm <sup>2</sup>	0,75-2,5	0,75-2,5	0,75-2,5	0,75-2,5	0,75-2,5	0,75-2,5	0,75-2,5	0,75-2,5	0,75-2,5
flexible	mm <sup>2</sup>	0,75-2,5	0,75-2,5	0,75-2,5	0,75-2,5	0,75-2,5	0,75-2,5	0,75-2,5	0,75-2,5	0,75-2,5
flexible with multicore cable end	mm <sup>2</sup>	0,5-1,5	0,5-1,5	0,5-1,5	0,5-1,5	0,5-1,5	0,5-1,5	0,5-1,5	0,5-1,5	0,5-1,5
	solid AWG	14 - 12	14 - 12	14 - 12	14 - 12	14 - 12	14 - 12	14 - 12	14 - 12	14 - 12
	flexible AWG	18 - 12	18 - 12	18 - 12	18 - 12	18 - 12	18 - 12	18 - 12	18 - 12	18 - 12
Cables per clamp		2	2	2	2	2	2	2	2	2

### Data according to CSA, UL and CUL

Type		HN	HTN	HA	HB..	HKA, HKT HKF	K2-DK K2-SK	K2-L <sup>2)</sup>
Rated operational current "General Use"	A	10	10	16	10	10	-	-
Rated operational voltage	max. V AC	600	600	600	600	600	-	600
<b>Auxiliary Contacts</b>		A600	A600	A600	A600	A600	-	Intermittent duty

1) Suitable for: earthed-neutral systems, overvoltage category I to IV, pollution degree 3 (standard-industry):  $U_{imp} = 8kV$ . Data for other conditions on request.

2) Command duration min. 30ms, 10% duty cycle, max. 30 sec.

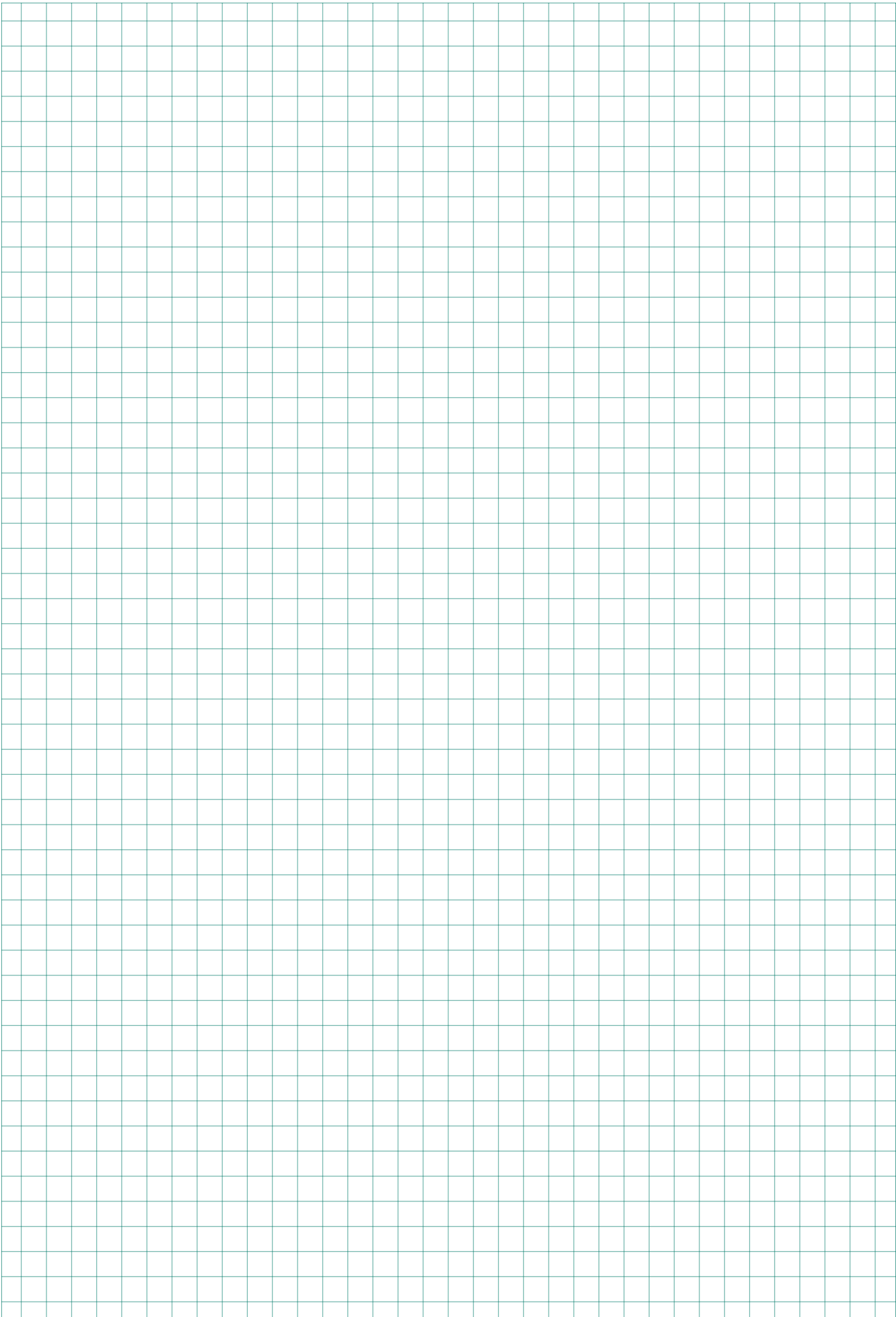

Contactors, Motor-Starters

Circuit Breakers

Manual Motor-Starters

Switches

AC-Main Switches

DC-Switch Disconnector

Push Buttons

Representatives, Suppliers

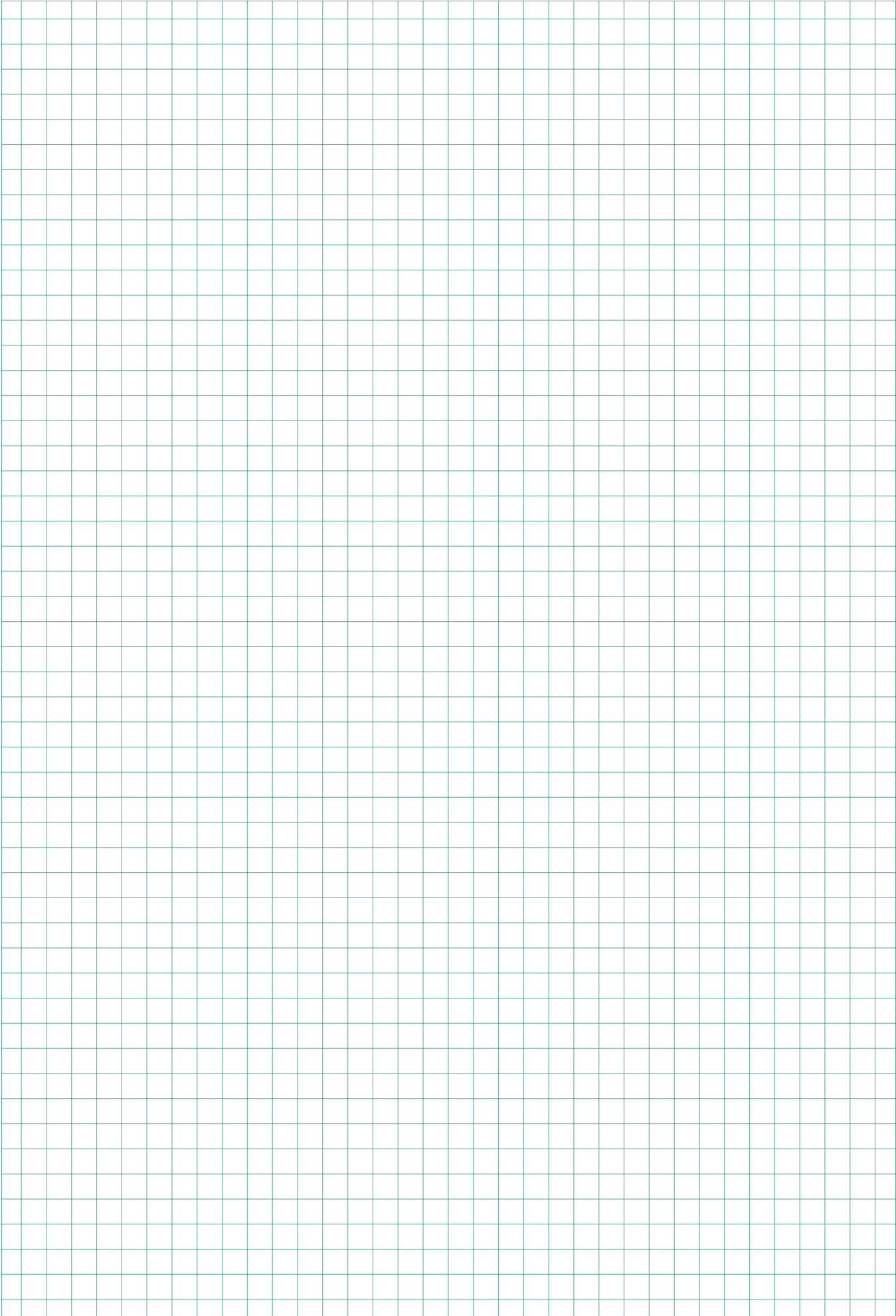

# Contactors and Accessories

## Wiring diagrams

### Auxiliary contact blocks

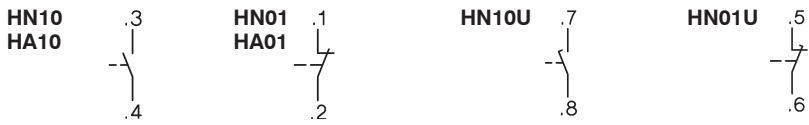

### Snap-on momentary contact blocks

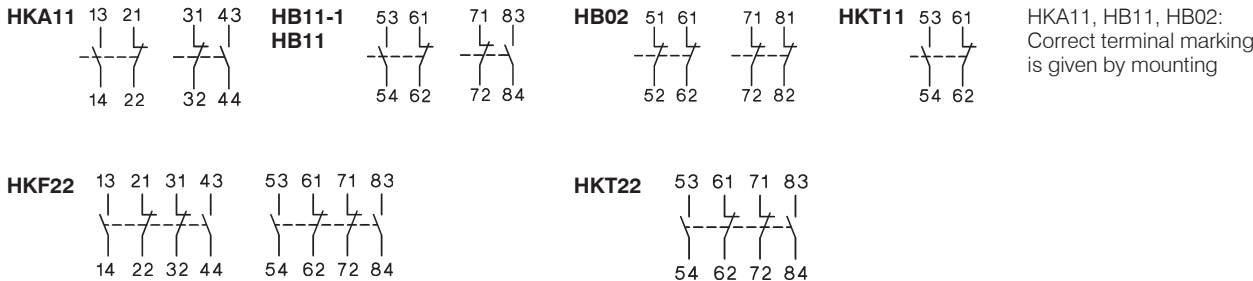
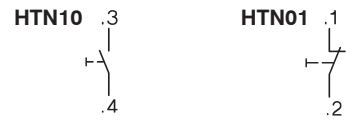

### Electronic timer

#### K3-T180 240

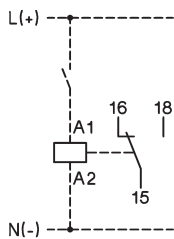

### Latch

#### K2-L..

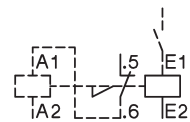

### Fuse holder

#### K2-F



with rectifier

#### K2-RF1 K2-RF3

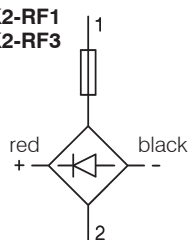

Colours mentioned in wiring diagram refer to the outgoing connection wires of the device.

### Regulation of switch position of aux. contact block HKF22 for contactors K3-450 to K3-860

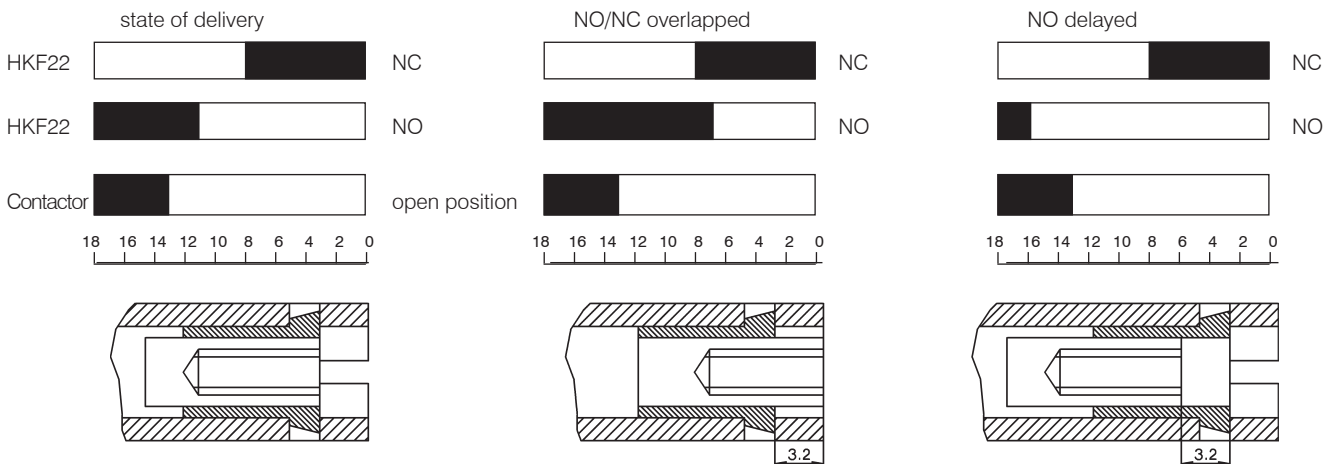

Stand position of regulation screw

Regulation screw position (unscrew by 4 turns)

Regulation screw position (screw by 4 turns)

# Contactors

## Dimensions

### AC operated

K3-10N..  
K3-14N..  
K3-18N..  
K3-22N..

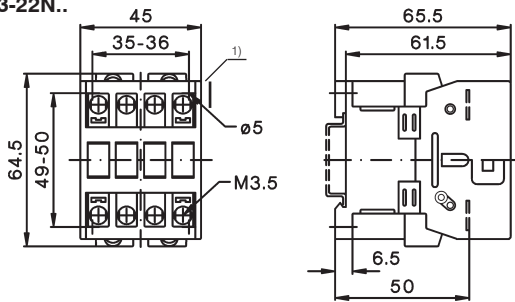

K3-24..  
K3-32..  
K3-40..

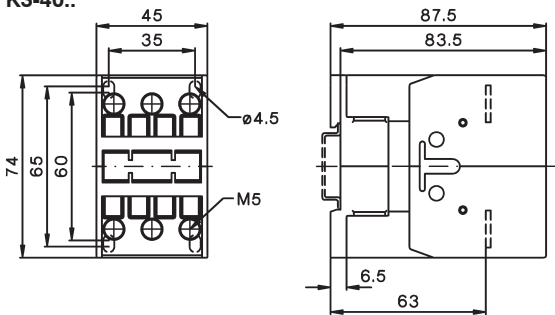

K3-50..  
K3-62..  
K3-74..

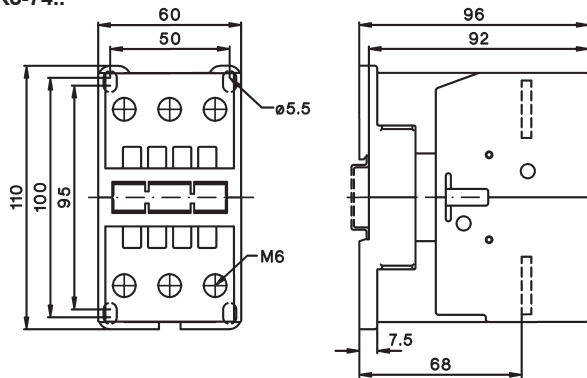

### AC and DC operated

K3-90..  
K3-115..

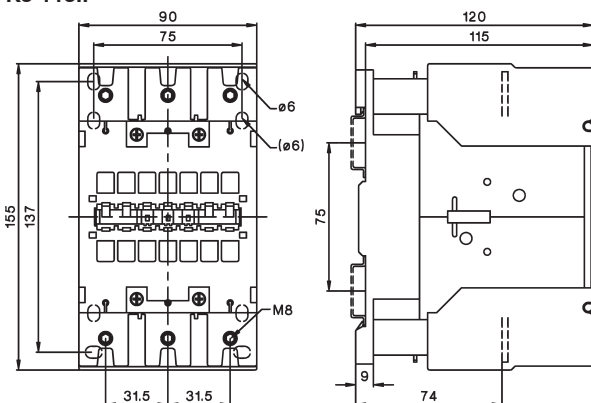

### DC operated

KG3-10..  
KG3-14..  
KG3-18..  
KG3-22..

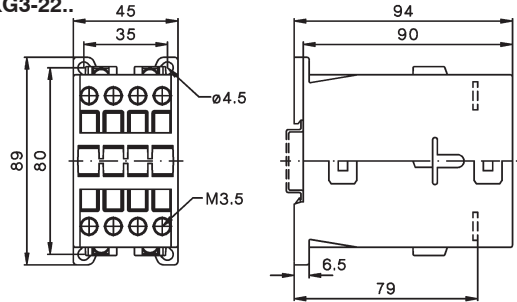

KG3-24..  
KG3-32..  
KG3-40..

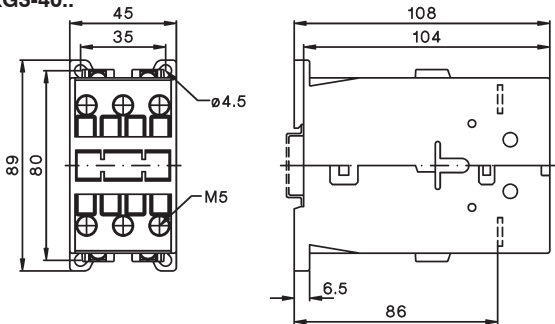

K3-50..=  
K3-62..=  
K3-74..=

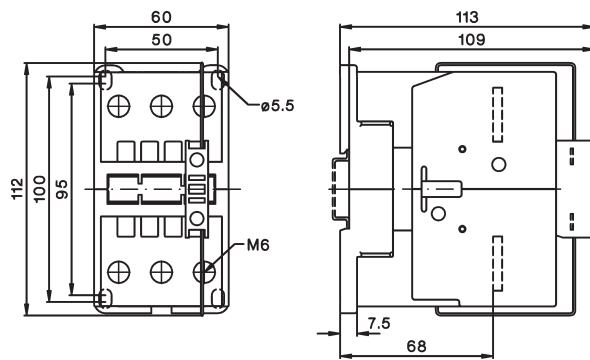

1) Minimum side distance to  
conductive parts for coil voltage:  
500V  $U_{imp}=6kV$  2mm  
660-690V  $U_{imp}=8kV$  4,5mm

# Contactors

Dimensions, AC operated, DC operated

K3-151..  
K3-176..

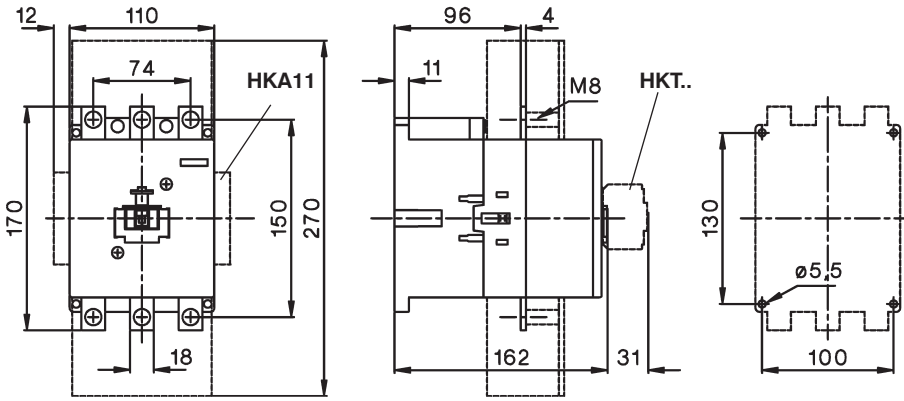

K3-210..  
K3-260..  
K3-316..

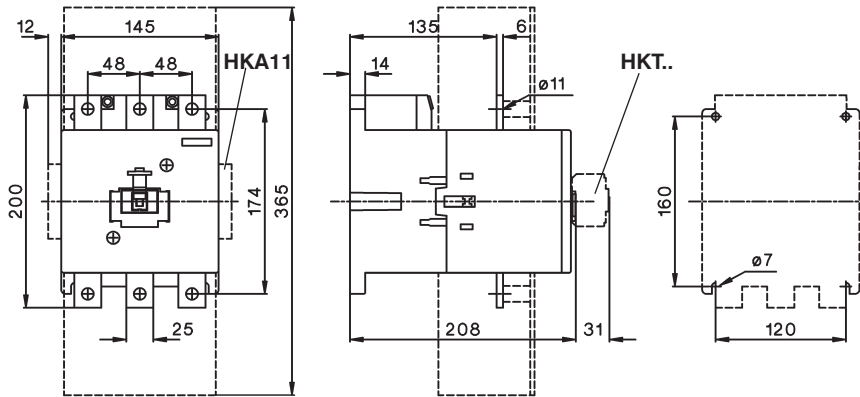

K3-450..  
K3-550..

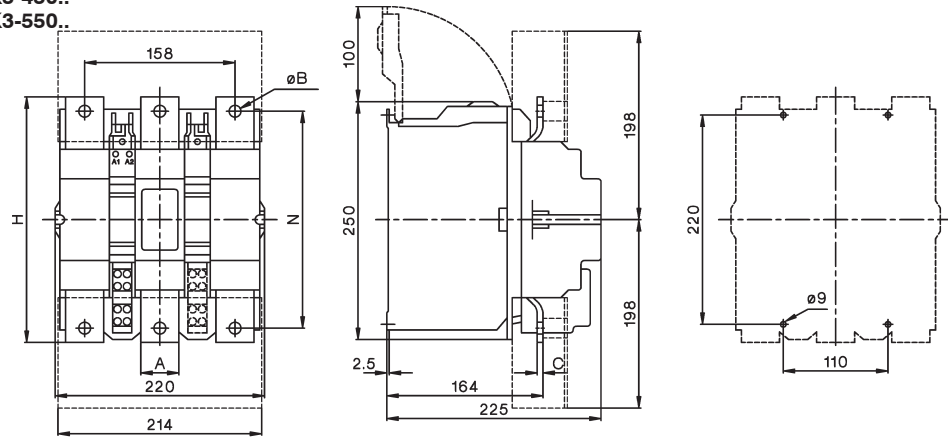

Type	A	B	C	H	N
K3-450	40	10,5	4	233	206
K3-550	40	12,5	6	258	228

K3-700..  
K3-860..

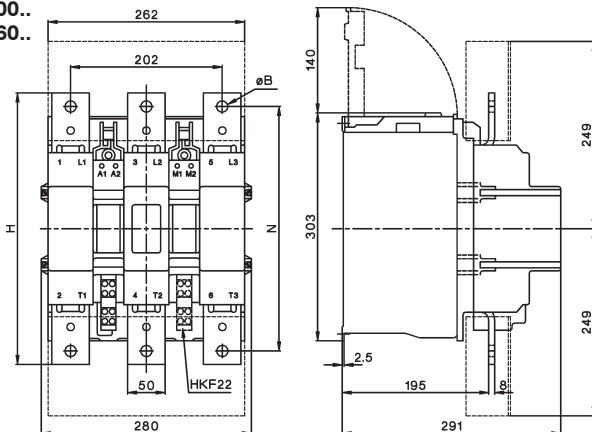

Type	B	H	N
K3-700	13	310	277
K3-860	15	361	325

# Contactors

## Dimensions

AC operated, DC operated

K3-1000..

K3-1200..

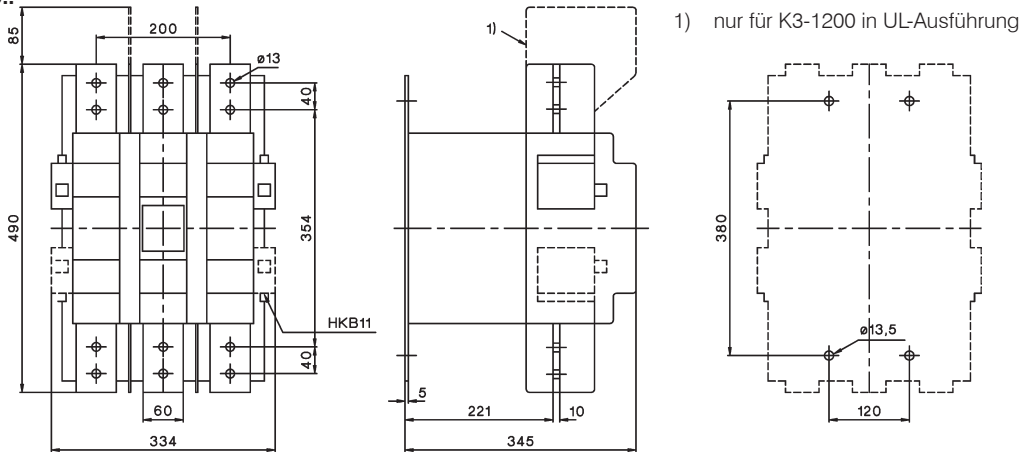

Capacitor Switching Contactors, AC operated

K3-18NK..

K3-18NBK..

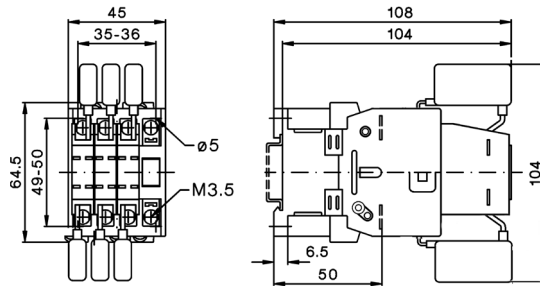
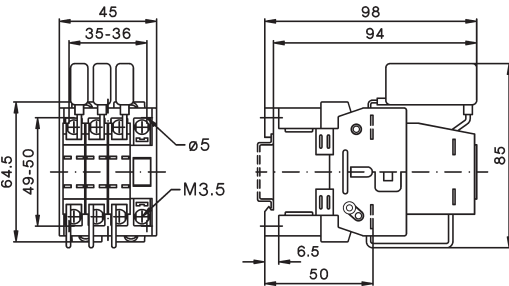

K3-24K..

K3-32K..

K3-50K..

K3-62K..

K3-74K..

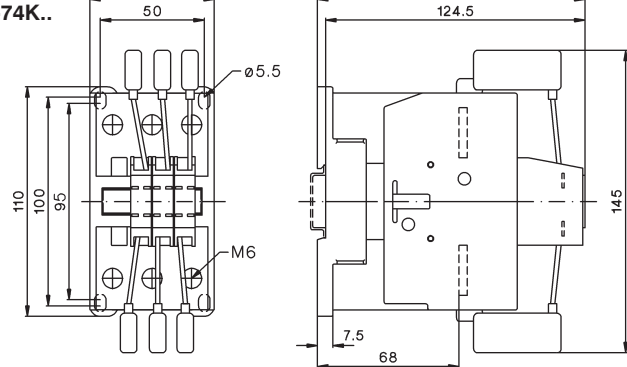
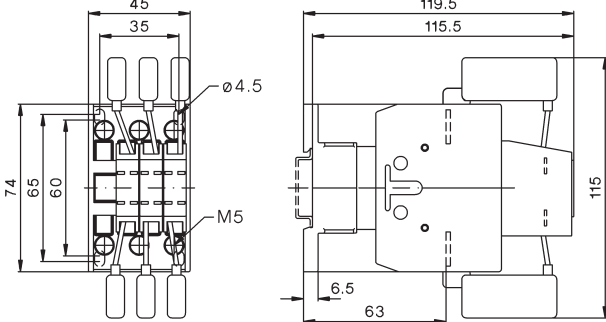

K3-90K..

K3-115K..

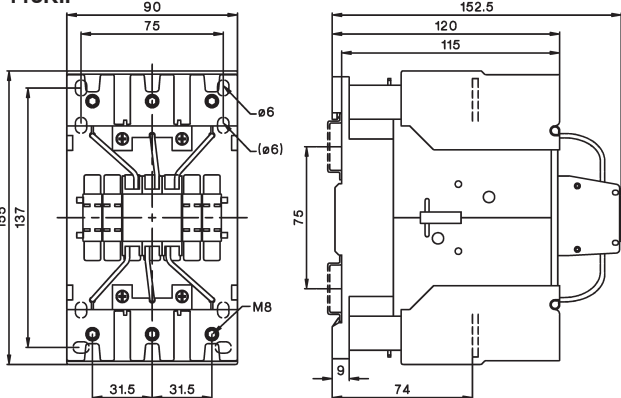

# Contactors

## Dimensions

### Contactors DC operated

- K3-10N..=
- K3-14N..=
- K3-18N..=
- K3-22N..=

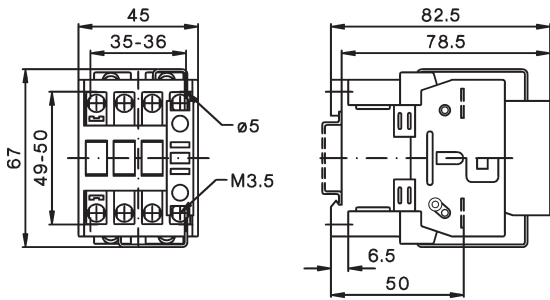

- K3-24..=
- K3-32..=
- K3-40..=

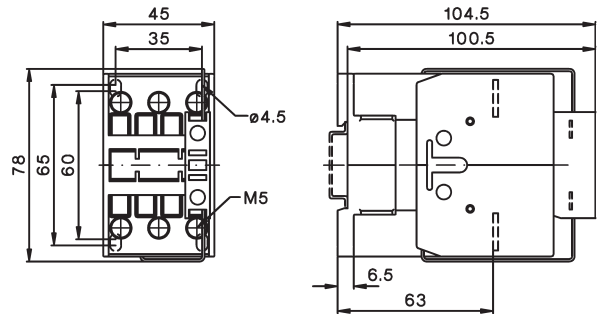

### Contactors 4-pole, AC operated / DC operated

- K3-10NA00-40
- K3-14NA00-40
- K3-18NA00-40
- K3-22NA00-40

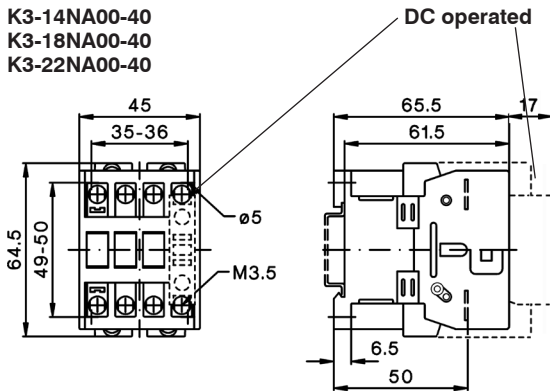

- K3-24A00-40
- K3-32A00-40
- K3-40A00-40

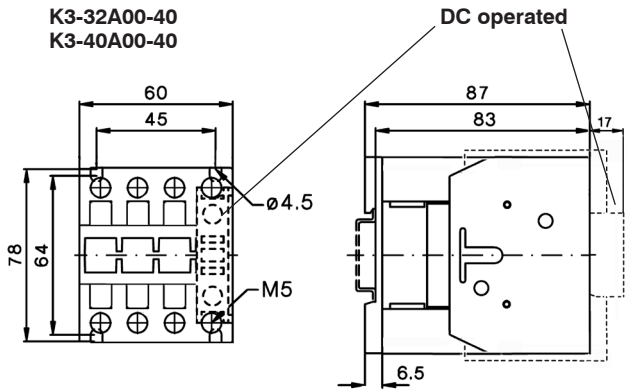

### Contactors 4-pole, AC operated / DC operated

- K3-50A00-40
- K3-62A00-40
- K3-74A00-40

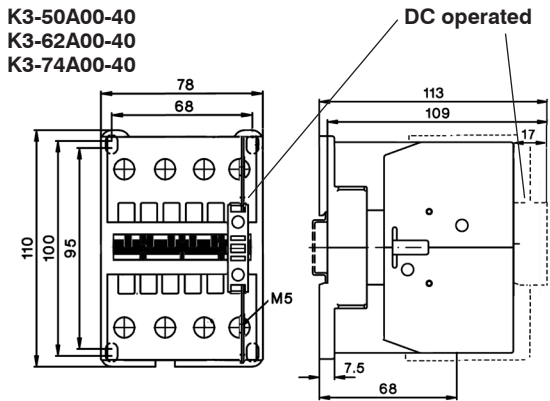

### K3-96A00-40

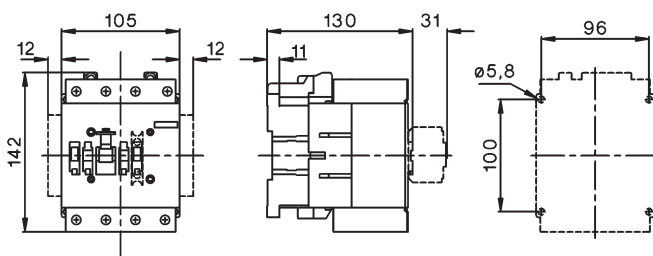

### K3-116A00-40 K3-151A00-40 K3-176A00-40

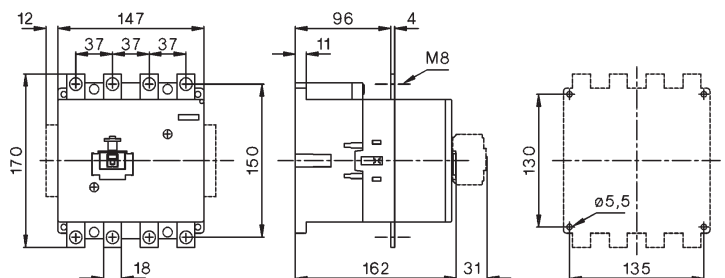

# Contactors

Contactors 4-pole, AC and DC operated

K3-210A00-40  
K3-260A00-40  
K3-316A00-40

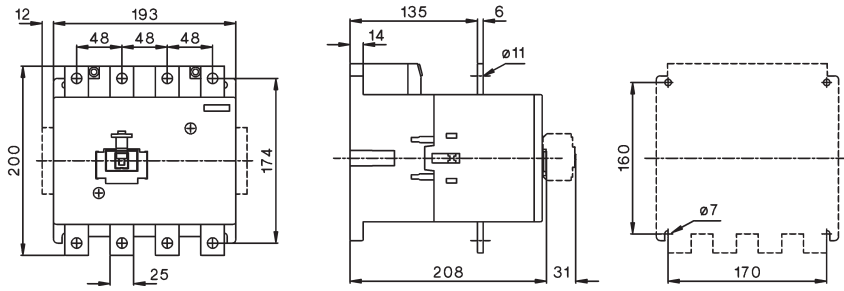

## Dimensions Accessories

Aux. cont. blocks, terminal blocks

Snap-on momentary cont. blocks

Auxiliary contact blocks

HN10, HN01

K2-SK, K2-DK

HTN10, HTN01

HA10, HA01

HB11-1, HB11, HB02

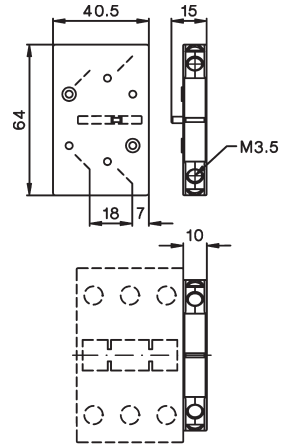
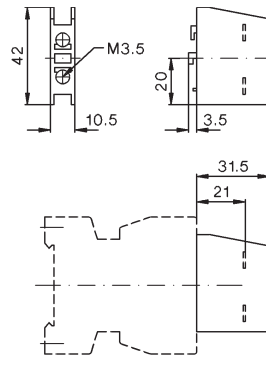
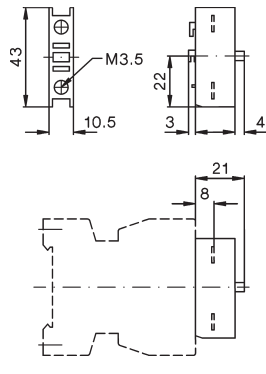
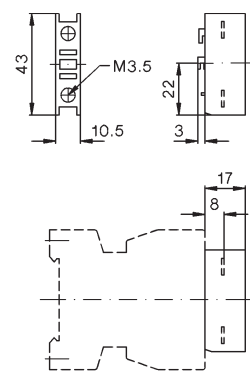

## 4. pole for contactors K3-200 to K3-1200

Type	A	B	C	D	E	F	G	H
NP175	223	148	26	52	98	5	122	M8
NP350	223	148	26	52	98	5	122	M8
NP325	262	148	26	55	116	5	122	M10
NP500	294	220	53	72	138	5	152	M12
NP760	294	220	53	72	138	5	152	M12
NP501	348	220	53	73	145	5	152	M12
NP1000	348	220	53	73	145	8	152	M12
NP1001	410	220	53	110	157	8	152	M12

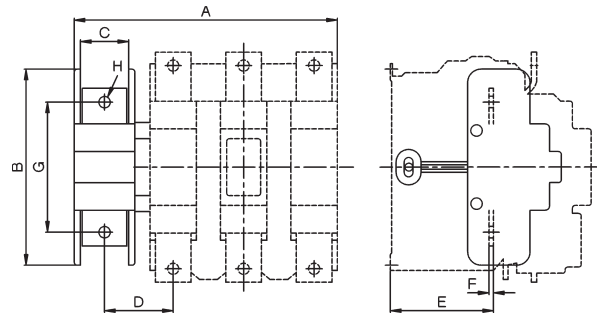

## Electronic timer

K3-T180 240

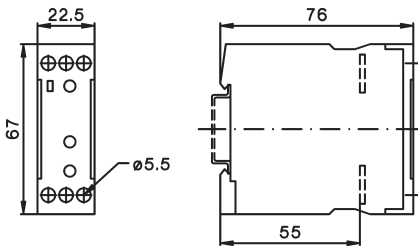

## Electronic timer on-delay

K2-TE..

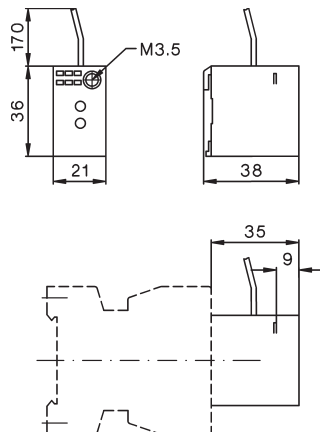

# Contactors

## Dimensions Accessories

### Mechanical interlocks

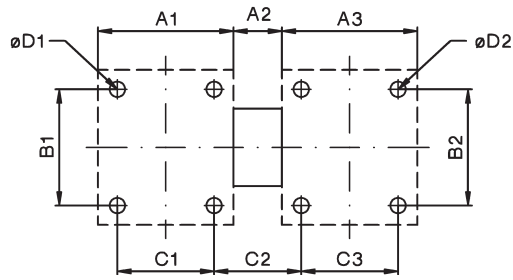

Type	Contactor 1	Contactor 2	A1	A2	A3	B1	B2	C1	C2	C3	D1	D2	
<b>LG10889</b>	K3-07 to K3-40	K3-07 to K3-40	45	7	45	50	50	35	17	35	4,5	4,5	
<b>LG10889</b>	KG3-07 to KG3-22	KG3-07 to KG3-22	45	7	45	80	50	35	17	35	4,5	4,5	
<b>LG10889</b>	KG3-24 to KG3-40	KG3-22 to KG3-40	45	7	45	80	50	35	17	35	4,5	4,5	
<b>LG10890</b>	K3-50 to K3-74	K3-24 to K3-40	60	12	55	100	65	50	22	45	5,5	4,5	
<b>LG10890</b>	K3-50 to K3-74	K3-50 to K3-74	60	12	60	100	100	50	22	50	5,5	5,5	
<b>LG11478</b>	K3-90 to K3-115	K3-90 to K3-115	90	12	90	100	100	75	27	75	5,5	5,5	
<b>LG8511</b>	K65 - K110	K65 - K110	90	12	90	100	100	75	27	75	6	6	
<b>LG11223H</b>	K3-151, -176	K3-151, -176	110	30	110	130	130	100	40	100	6	6	3-pole contactor
<b>LG11223H</b>	K3-116,-151, -176	K3-116,-151, -176	147	30	147	130	130	135	42	135	6	6	4-pole contactor
<b>LG11223H</b>	K3-210, -260, -316	K3-210, -260, -316	145	30	145	160	160	120	55	120	6	6	3-pole contactor
<b>LG11223H</b>	K3-210, -260, -316	K3-210, -260, -316	193	30	193	160	160	170	55	170	6	6	4-pole contactor
<b>LG10400H</b>	K3-450, K3-550	K3-450, K3-550	220	42	220	220	220	110	152	110	9	9	
<b>LG10402H</b>	K3-700, -860	K3-700, -860	280	32	280	280	280	175	137	175	11	11	
<b>LG10403H</b>	K3-1000, -1200	K3-1000, -1200	334	46	334	380	380	120	260	120	13,5	13,5	
<b>LG10399H</b>	K3-450, -550	K3-700, -860	220	37	280	220	280	110	144,5	175	9	11	
<b>LG10401H</b>	K3-700, -860	K3-1000, -1200	280	73	334	280	380	175	232,5	120	11	13,5	

**LG10400V, LG10402V**

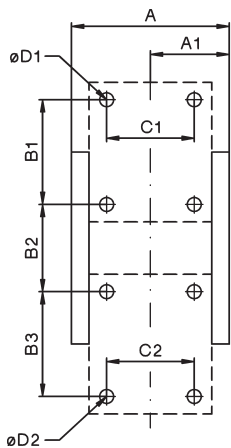

**LG10399V**

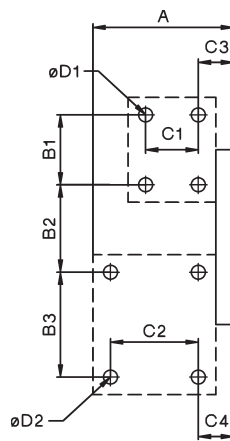

**LG10403V, LG10401V**

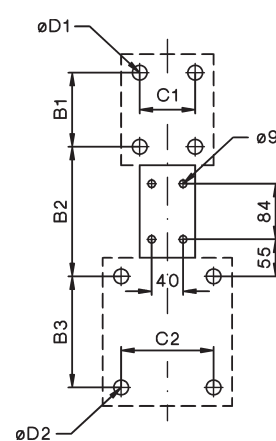

Type	Contactor 1	Contactor 2	A	A1	B1	B2	B3	C1	C2	C3	C4	D1	D2
<b>LG10400V</b>	K3-315 - K3-550	K3-315 - K3-550	250	134	220	94	220	110	110	-	-	9	9
<b>LG10402V</b>	K3-700, -860	K3-700, -860	302	162	280	200	280	175	175	-	-	11	11
<b>LG10403V</b>	K3-1000, -1200	K3-1000, -1200	-	-	380	280	380	120	120	-	-	13,5	13,5
<b>LG10399V</b>	K3-450, -550	K3-700, -860	302	-	220	150	280	110	175	51	74,5	9	11
<b>LG10401V</b>	K3-700, -860	K3-1000, -1200	-	-	280	240	380	175	120	-	-	11	13,5

# Contactors

## Dimensions Accessories

### Latch

#### K2-L..

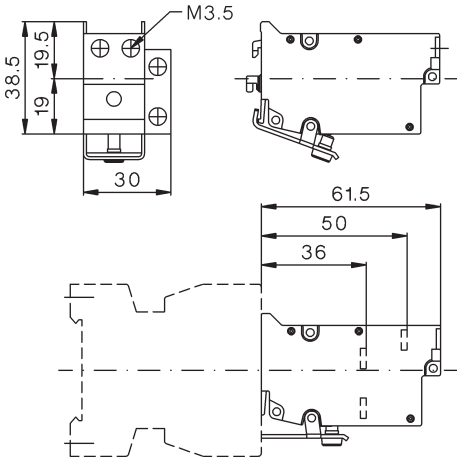

### Contactors with additional terminals

#### LG9339N (2 x 3 pieces) for K3-10N. to K3-22N.

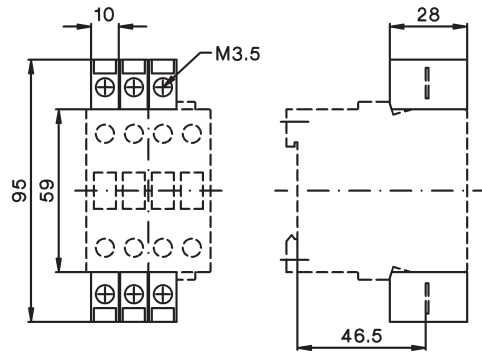

### Fuse holder

#### K2-RF

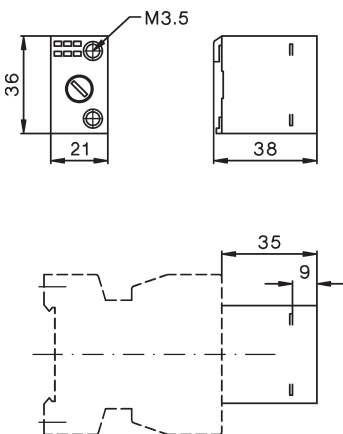

### Fuse holder with rectifier

#### K2-RF1 K2-RF3

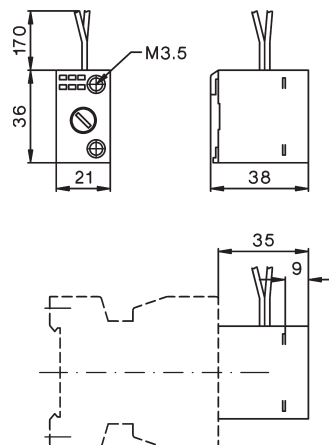

# Contactors

## Dimensions Accessories

### Snap-on adapter

#### K2-SM

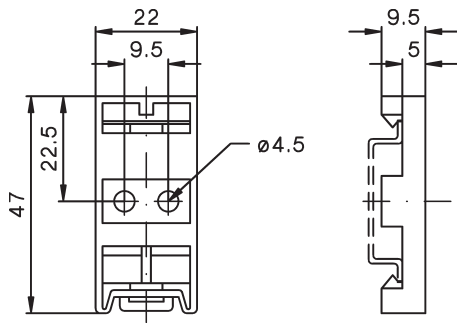

### Suppressor units

#### RC-K3 ..

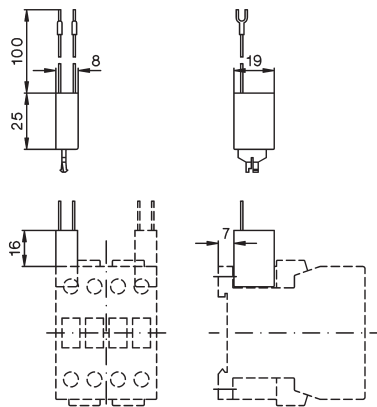

### Marking systems

marking label

**P487-1** or **P245-**

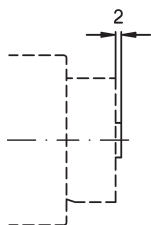

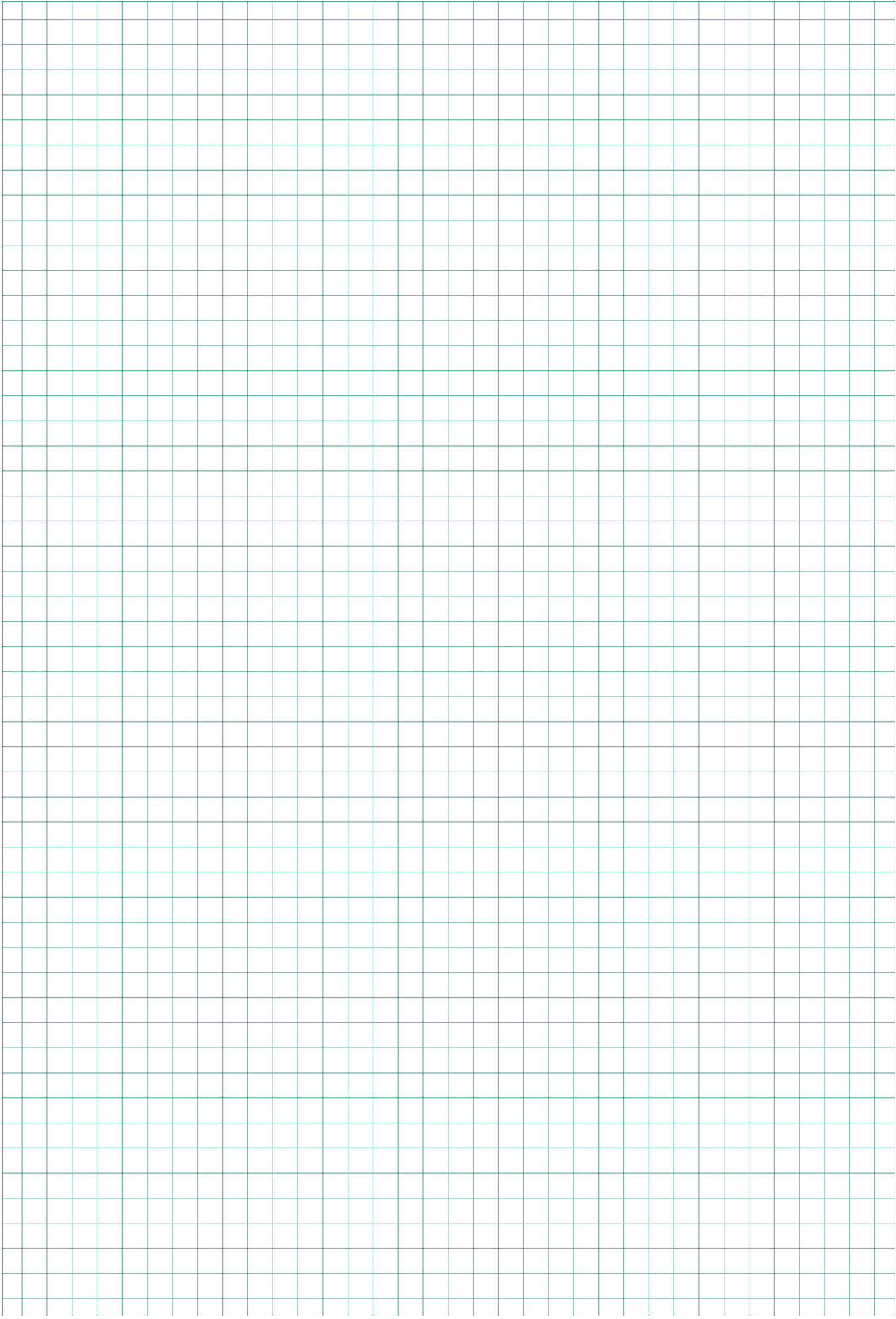

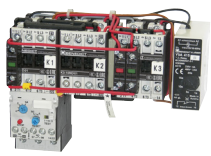

Star-Delta Starters Open Type

92



Star-Delta Starters Enclosed  
Enclosure for Star-Delta Starters

94  
94

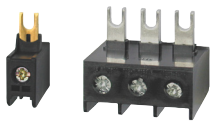

Accessories

95



Reversing Contactors

96



Pole Changing Starters

98



Technical Data

100

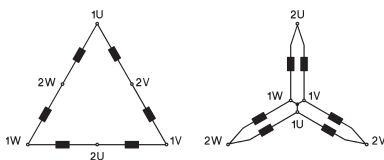

Wiring Diagrams

103

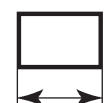

Dimensions

107

# Star-Delta Starters Open Type

AC Operated

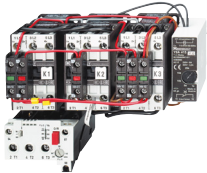

Ratings		Rated Current		order separately	Type	Coil voltage <sup>1)</sup>	Pack pcs.	Weight kg/pc.
AC3	380V	660V	AC3	Overload Relay	230	220-240V 50Hz		
400V	415V	500V	690V	400V	400	380-415V 50Hz		
kW	kW	kW	A	Type	↓			
7,5	7,5	11	16	U3/32 U12/16E K3	<b>K3NY15 ...</b>		1	0,9
15	18,5	15	30		<b>K3NY26 ...</b>		1	0,9
22	30	22	45	U3/42	<b>K3Y40 ...</b>		1	1,4
30	37	30	60		<b>K3Y52 ...</b>		1	1,8
45	55	45	85	U3/74	<b>K3Y80 ...</b>		1	3,5
55	75	55	109		<b>K3Y100 ...</b>		1	3,7
75	90	90	150	U85	<b>K3Y140 ...</b>		1	6,6
110	132	110	205		<b>K3Y200 ...</b>		1	7
132	160	160	240	U180	<b>K3Y240 ...</b>		1	15
160	180	180	300		<b>K3Y300 ...</b>		1	15

Star-delta starters are wired to accept thermal overload relay. The thermal overload relay has to be ordered separately. For full load current setting use the YD-dial of thermal overload relay.

**Ordering Example:** Star-Delta Starter, open type, rated AC3 at 400V 205A rated control voltage 230V 50Hz - **Order Type: K3Y200 230 + U85 120**

## Thermal Overload Relays

Rated Motor Current A	Type	Pack pcs.	Weight kg/pc.	Wiring Diagram
--------------------------	------	-----------	---------------	----------------

For Star-Delta Starters K3NY15.. to K3Y40..



7 - 10,5	<b>U12/16E 6 K3</b>	1	0,10	
10,5 - 15,5	<b>U12/16E 9 K3</b>	1	0,10	
14 - 19	<b>U12/16E 11 K3</b>	1	0,10	
18 - 24	<b>U12/16E 14 K3</b>	1	0,10	
23 - 31	<b>U12/16E 18 K3</b>	1	0,10	

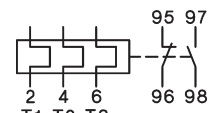

manual reset

For Star-Delta Starters K3NY15.. to K3Y52..



7 - 10,5	<b>U3/32 6</b>	1	0,14	
10,5 - 15,5	<b>U3/32 9</b>	1	0,14	
14 - 19	<b>U3/32 11</b>	1	0,14	
18 - 24	<b>U3/32 14</b>	1	0,14	
23 - 31	<b>U3/32 18</b>	1	0,14	
30 - 41	<b>U3/32 24</b>	1	0,14	
40 - 55	<b>U3/32 32</b>	1	0,14	

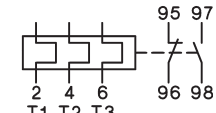

manual and auto reset

For Star-Delta Starters K3Y40.., K3Y52..



24 - 35	<b>U3/42 20</b>	1	0,30	
35 - 48	<b>U3/42 28</b>	1	0,30	
48 - 73	<b>U3/42 42</b>	1	0,30	

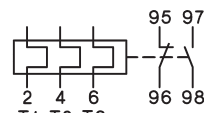

manual and auto reset

1) Coil voltage range and other coil voltages see page 100

Components for Combinations			Electronic Timer	Mechanical Interlock between K2 and K3	Star-Delta Starter Connector Type	Auxiliary Contacts Built-in for use on Contactor			Free Space for Aux. Contact Blocks on Contactor		
Line Contactor	Delta Contactor	Star Contactor				Line K1	Delta K2	Star K3	Line K1	Delta K2	Star K3
K1 Type	K2 Type	K3 Type	K4 Type	K2 and K3 Type							
K3-10ND01 + HN10	K3-10ND01	K3-10ND10 + HN10 + HN01	Y9A	LG10889	K3NY-VB10	-	-	-	3	4	2
K3-18ND01 + HN10	K3-18ND01	K3-14ND10 + HN10 + HN01	Y9A	LG10889	K3NY-VB10	-	-	-	3	4	2
K3-24A00 + HN10 + HN01	K3-24A00 + HN01	K3-24A00 + 2HN10 + HN01	Y9A	LG10889	K3Y-VB24	-	-	-	2	3	1
K3-32A00 + HN10 + HN01	K3-32A00 + HN01	K3-24A00 + 2HN10 + HN01	Y9A	LG10889	K3Y-VB24	-	-	-	2	3	1
K3-50A00 + HN01 + HN10	K3-50A00 + HN01	K3-32A00 + 2HN10 + HN01	Y9A	LG10890	-	-	-	-	2	3	1
K3-62A00 + HN01 + HN10	K3-62A00 + HN01	K3-50A00 + 2HN10 + HN01	Y9A	LG10890	-	-	-	-	2	3	1
K3-90A00 + HN01 + HN10	K3-90A00 + HN01	K3-90A00 + 2HN10 + HN01	Y9AL	LG11478	-	-	-	-	5	6	4
K3-115A00 + HN01 + HN10	K3-115A00 + HN01	K3-90A00 + 2HN10 + HN01	Y9AL	LG11478	-	-	-	-	5	6	4
K3-151A00 + HKT11	K3-151A00 + HKT11	K3-151A00 + HKT22	Y9AL	LG11223H	-	-	1/-	-/1	2	1	1
K3-176A00 + HKT11	K3-176A00 + HKT11	K3-151A00 + HKT22	Y9AL	LG11223H	-	-	1/-	-/1	2	1	1

**Applications**

The star-delta starting method is only practicable in such cases where the motor windings are connected in delta configuration for normal operation and the torque which is needed during the starting period is not higher than approx. 30% of the rated torque. The starting current drawn from the line will be approx. 2 to 2,7 times the rated motor current.

**Time setting**

The transition from start (star configuration) to normal operation (delta configuration) should be after the motor achieves practically full rotational speed. The use of star-delta timer Y9A with a dwell period of approx. 25ms provides a careful operation of motor and drive equipment.

**Thermal Overload Relays**



**Rated Motor Current**  
A

**Type**

Pack pcs. Weight kg/pc.

Wiring Diagram

For Star-Delta Starters K3Y80.., K3Y100..

35 - 48	<b>U3/74 28</b>	1	0,40
48 - 73	<b>U3/74 42</b>	1	0,40
70 - 90	<b>U3/74 52</b>	1	0,40
90 - 112	<b>U3/74 65</b>	1	0,40

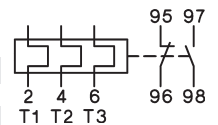

manual and auto reset

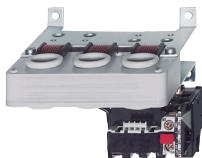

For Star-Delta Starters K3Y140.., K3Y200..

104 - 156	<b>U85 90</b>	1	0,90
140 - 207	<b>U85 120</b>	1	0,90

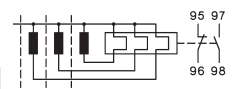

manual reset

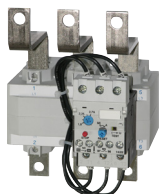

For Star-Delta Starters K3Y240.., K3Y300..

208 - 312	<b>U180 180</b>	1	1,5
-----------	-----------------	---	-----

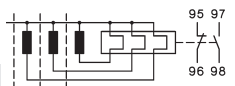

manual and auto reset

# Star-Delta Starters Enclosed Type

AC Operated

Ratings		Rated Current	Optional Extras	Wired to accept Overload Relay	Type	Coil voltage <sup>1)</sup>	Pack pcs.	Weight kg/pc.
AC3						220-240V 50Hz		
<b>380V</b>					<b>230</b>	380-415V 50Hz		
<b>400V</b>	660V	AC3			<b>400</b>			
<b>415V</b>	500V	690V	400V		↓			
<b>kW</b>	kW	kW	A	Type				



## Plastic Enclosed, protected to IP65

Rated Current	Rated Power (kW)	Rated Voltage (V)	Rated Current (A)	Optional Extras	Wiring	Type	Pack pcs.	Weight kg/pc.
7,5	7,5	11	16	ST	U3/32	<b>K3NY15P ...</b>	1	1,8
15	18,5	15	30	ST		<b>K3NY26P ...</b>	1	1,8
22	30	22	45	ST, H	U3/42	<b>K3Y40P ...</b>	1	3,8
30	37	30	60	ST, H		<b>K3Y52P ...</b>	1	4,2
45	55	45	85	ST, H	U3/74	<b>K3Y80P ...</b>	1	5,9
55	75	55	109	ST, H		<b>K3Y100P ...</b>	1	8,7



## Sheet Steel Enclosed, protected to IP54

Rated Current	Rated Power (kW)	Rated Voltage (V)	Rated Current (A)	Optional Extras	Wiring	Type	Pack pcs.	Weight kg/pc.
7,5	7,5	11	16	ST,H	U3/32	<b>K3NY15B ...</b>	1	2,8
15	18,5	15	30	ST, H		<b>K3NY26B ...</b>	1	2,8
22	30	22	45	ST, H	U3/42	<b>K3Y40B ...</b>	1	4,8
30	37	30	60	ST, H		<b>K3Y52B ...</b>	1	5,2
45	55	45	85	ST, H	U3/74	<b>K3Y80B ...</b>	1	15
55	75	55	109	ST, H		<b>K3Y100B ...</b>	1	15
75	90	90	150	ST, H	U85	<b>K3Y140B ...</b>	1	22
110	132	110	205	ST, H		<b>K3Y200B ...</b>	1	22

1) Coil voltage range and other coil voltages see page 100

### Type-suffix for optional extras

Start-Stop Push Buttons	.....T ...
Selector Switch	.....W ...
Control Circuit Fuse <250V (1 piece)	.....ST ...
>250V (2 pieces)	.....ST ...
Run Hour Meter	.....H ...

**Ordering Example:** Star-Delta Starter, steel sheet enclosed, with selector switch and run hour meter rated AC3 at 400V 82A, rated control voltage 230V 50Hz - **Order Type: K3Y80BWH 230 + U3/74 52**

## Enclosures for Star Delta Starter



for Starter	accept Overload Relay	Type	Pack pcs.	Weight kg/pc.
<b>Plastic IP65</b>				
<b>K3NY15, K3NY26</b>	U3/32	<b>K3Y26P-G3</b>	1	1,0
<b>K3Y40, K3Y52</b>	U3/42, U3/32	<b>K3Y40/52P-G3</b>	1	2,4
<b>Sheet Steel IP54</b>				
<b>K3NY15, K3NY26</b>	U3/32	<b>K3Y26B-G3</b>	1	3,4
<b>K3Y40, K3Y52</b>	U3/42, U3/32	<b>K3Y40/52B-G3</b>	1	3,4

## Star-Delta Starter Connector



For Star-Delta Starter Types

	Type	Pack pcs.	Weight kg/pc.
K3NY15, K3NY26	<b>K3NY-VB10</b>	1	0,02
K3Y40, K3Y52	<b>K3Y-VB24</b>	1	0,03

## Additional Terminals



For Star-Delta Starter Types  
Line Conn. Motor Conn.  
Line Contactor Overload Relay

Cable cross-section mm<sup>2</sup>

Type

Pack pcs. Weight kg/pc.

### Single pole with Fingertouch Protection

K3NY15, K3NY26	U12/16	0,75 - 10 solid 0,75 - 6 flex.	<b>LG9339</b>	6	0,009
----------------	--------	-----------------------------------	---------------	---	-------

### Three-pole with Fingertouch Protection

	U3/42	4 - 35 strand. 4 - 25 flex.	<b>LG7559</b>	1	0,052
--	-------	--------------------------------	---------------	---	-------

## Electronic Timers for Star-Delta Starters<sup>1)</sup>



Rated Control Voltage V	Time Range s	Delay Time ms	Rated Current AC15		Type	Pack pcs.	Weight kg/pc.
			250V A	400V A			
24 - 60V AC/DC	1 - 20 <sup>2)</sup>	20 - 25	5	5	<b>Y9A 60</b>	1	0,075
110 - 415V AC/DC	1 - 20 <sup>2)</sup>	20 - 25	5	5	<b>Y9A 415</b>	1	0,075
24 - 60V AC/DC	1 - 20 <sup>2)</sup>	40 - 80	5	5	<b>Y9AL 60</b>	1	0,075
110 - 415V AC/DC	1 - 20 <sup>2)</sup>	40 - 80	5	5	<b>Y9AL 415</b>	1	0,075

Time repeat accuracy	± 1%
Minimum interval between operations	2s
Short circuit protection	4A gl (gG)

Power consumption at	24V	0,2VA
	60V	5VA
220-240V	2VA	
380-415V	7VA	

1) not suitable for contactors K3-450 - K3-1200  
2) - 20% / + 30%

## Mounting Bar

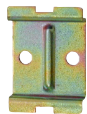

Specification	Type	Pack pcs.	Weight kg/pc.
For screw mounting of electronic timer Y9..	<b>LG7735</b>	10	0,09

## Star-Delta Starters in Special Versions

### Starters for Longer Starting Time

For longer starting times the thermal overload relay is mounted on delta-contactor. The motor is not protected in Y-connection. The timer used for this starter-type is the type Y91A, time range is 10 to 60s. Principal wiring diagram see page 104.

**Ordering Example:** K3YL52 230

### Starters with two Thermal Overload Relays on request

Basic circuit diagram see page 104

## Reversing Contactors with Mechanical Interlock

AC Operated

Ratings	Rated Current	Vorbereitet für Einbau	Wired to accept Overload Relay page 120 Type	Type	Coil voltage <sup>1)</sup>	Pack pcs.	Weight kg/pc.
AC3					110V 50Hz		
<b>380V</b>					220-240V 50Hz		
<b>400V</b>		660V	AC3		380-415 50Hz		
<b>415V</b>	500V	690V	400V				
<b>kW</b>	kW	kW	A				

### Open Type

<b>4</b>	5,5	5,5	10	U3/32 U12/16E K3	<b>K3NWU10 ...</b>	1	0,6
<b>7,5</b>	10	7,5	18		<b>K3NWU18 ...</b>	1	0,6
<b>11</b>	15	15	24	U3/42	<b>K3WU24 ...</b>	1	1,2
<b>15</b>	18,5	18,5	32		<b>K3WU32 ...</b>	1	1,4
<b>18,5</b>	18,5	18,5	40		<b>K3WU40</b>	1	1,4
<b>22</b>	30	30	50	U3/74	<b>K3WU50 ...</b>	1	2,5
<b>30</b>	37	37	62		<b>K3WU62 ...</b>	1	2,5
<b>37</b>	45	45	74		<b>K3WU74 ...</b>	1	2,5

### Sheet Steel Enclosed, protected to IP54

<b>4</b>	5,5	5,5	10	U3/32	<b>K3NWU10B ...</b>	1	3,9
<b>7,5</b>	10	7,5	18		<b>K3NWU18B ...</b>	1	4,1
<b>11</b>	15	15	24	U3/42	<b>K3WU24B ...</b>	1	4,5
<b>15</b>	18,5	18,5	32		<b>K3WU32B ...</b>	1	4,7
<b>22</b>	30	30	50	U3/74	<b>K3WU50B ...</b>	1	7,1
<b>30</b>	37	37	62		<b>K3WU62B ...</b>	1	7,1

## Reversing Starter Connector



For Reversing Starter Types	For Industrial Contactors	Type	Pack pcs.	Weight kg/pc.
K3NWU10, K3NWU18	K3-10 to K3-22	<b>K3NW-VB10</b>	1	0,02
K3WU24, K3WU32, K3WU40	K3-24 to K3-40	<b>K3W-VB24</b>	1	0,025

Components for Combinations		Mechanical Interlock	Reversing Starter Connector	Auxiliary Contacts Built-in for use on Contactor		Free Space for Aux. Contact Blocks on Contactor	
Left Hand Side Contactor	Right Hand Side Contactor			K1 NO/NC	K2 NO/NC	K1 HN.. or HA..	K2
K1 Type	K2 Type	Type	Type				
K3-10ND10 + HN01	K3-10ND10 + HN01	LG10889	K3NW-VB10	-	-	3	3
K3-18ND10 + HN01	K3-18ND10 + HN01	LG10889	K3NW-VB10	-	-	3	3
K3-24A00 + HN10 + HN01	K3-24A00 + HN10 + HN01	LG10889	K3W-VB24	-	-	2	2
K3-32A00 + HN10 + HN01	K3-32A00 + HN10 + HN01	LG10889	K3W-VB24	-	-	2	2
K3-40A00 + HN10 + HN01	K3-40A00 + HN10 + HN01	LG10889	K3W-VB24	-	-	2	2
K3-50A00 + HN10 + HN01	K3-50A00 + HN10 + HN01	LG10890	-	-	-	2	2
K3-62A00 + HN10 + HN01	K3-62A00 + HN10 + HN01	LG10890	-	-	-	2	2
K3-74A00 + HN10 + HN01	K3-74A00 + HN10 + HN01	LG10890	-	-	-	2	2
K3-10ND10 + HN01	K3-10ND10 + HN01	LG10889	K3NW-VB10	-	-	3	3
K3-18ND10 + HN01	K3-18ND10 + HN01	LG10889	K3NW-VB10	-	-	3	3
K3-24A00 + HN10 + HN01	K3-24A00 + HN10 + HN01	LG10889	K3W-VB24	-	-	2	2
K3-32A00 + HN10 + HN01	K3-32A00 + HN10 + HN01	LG10889	K3W-VB24	-	-	2	2
K3-50A00 + HN10 + HN01	K3-50A00 + HN10 + HN01	LG10890	-	-	-	2	2
K3-62A00 + HN10 + HN01	K3-62A00 + HN10 + HN01	LG10890	-	-	-	2	2

Contactors, Motor-Starter

Circuit Breakers

Manual Motor-Starters

Switches

AC-Main Switches

DC-Switch Disconnect

Push Buttons

Representatives, Suppliers

## Pole Changing Starters

AC Operated

Ratings		Rated Current		Wired to accept Overload Relay page 120 Type	Type	Coil voltage <sup>1)</sup> 220-240V 50Hz 380-415 50Hz	Pack pcs.	Weight kg/pc.
AC3	380V	660V	AC3					
400V			400V		230 400 ↓			
415V	500V	690V	400V					
kW	kW	kW	A					

### Open Type



Rated Current (A)	Rated Power (kW)	Rated Power (kW)	Rated Current (A)	Wired to accept Overload Relay	Type	Pack pcs.	Weight kg/pc.
7,5	10	10	18	2 x U3/32 2 x U12/16E K3	K3NPU18 ...	1	1,0
11	15	15	24		K3NPU24 ...	1	1,5
15	18,5	18,5	32	2 x U3/32	K3PU32 ...	1	1,9
22	30	30	50	2 x U3/74	K3PU50 ...	1	3,9
30	37	37	62		K3PU62 ...	1	3,9

### Sheet Steel Enclosed, protected to IP54



Rated Current (A)	Rated Power (kW)	Rated Power (kW)	Rated Current (A)	Wired to accept Overload Relay	Type	Pack pcs.	Weight kg/pc.
7,5	10	7,5	18	2x U3/32	K3NPU18B ...	1	1,0
11	15	15	24		K3NPU24B ...	1	1,5
15	18,5	18,5	32		K3PU32B ...	1	1,9

**Ordering Example:** Pole Changing Starter, open version, rated AC3 at 400V 28A and 15A, control voltage 230V 50Hz  
**Order Type:** K3PU32 230 + U3/32 32 + U3/32 18

Pole Changing Starters for Star-Delta Operation on request

1) Other coil voltages see page 57

Components for Combinations			Free Space for		
High Speed	Low Speed	Star Contactor	Aux. Contact Blocks on High Speed	Low Speed	Star
K1 Type	K2 Type	K3 Type	K1 HN.. or HA..	K2	K3
K3-18ND01 + 2 x HN10	K3-18ND01 + HN10	K3-14ND01	2	3	4
K3-24A00 + HN01 + 2 x HN10	K3-24A00 + HN01 + HN10	K3-18ND01	1	2	4
K3-32A00 + HN01 + 2 x HN10	K3-32A00 + HN01 + HN10	K3-24A00 + HN01	1	2	3
K3-50A00 + HN01 + 2 x HN10	K3-50A00 + HN01 + HN10	K3-32A00 + HN01	1	2	3
K3-62A00 + HN01 + 2 x HN10	K3-62A00 + HN01 + HN10	K3-50A00 + HN01	1	2	3
K3-18ND01 + 2 x HN10	K3-18ND01 + HN10	K3-14ND01	2	3	4
K3-24A00 + HN01 + 2 x HN10	K3-24A00 + HN01 + HN10	K3-18ND01	1	2	4
K3-32A00 + HN01 + 2 x HN10	K3-32A00 + HN01 + HN10	K3-24A00 + HN01	1	2	3

Contactors, Motor-Starter

Circuit Breakers

Manual Motor-Starters

Switches

AC-Main Switches

DC-Switch Disconnect

Push Buttons

Representatives, Suppliers

# Star-Delta Starters

## Data according to IEC 947-4-1, VDE 0660, EN 60947-4-1

Type		K3NY15	K3NY26	K3Y40	K3Y52	K3Y80	K3Y100	K3Y140	K3Y200	K3Y240	K3Y300	
<b>Main Contacts</b>												
Rated insulation voltage $U_i^{(1)}$	V AC	690	690	690	690	690	690	690	690	690	690	
Frequency of operations $z_{AC3, I_e}$	1/h	15										
Change-over time max. (Y-step)	s	20 (Type K3YL ... 60)										
<b>Utilization category AC3</b>												
<b>Switching of three-phase motors</b>												
Rated operational current $I_e$	220-230V	A	16	30	45	60	85	109	150	205	240	300
	240V	A	16	30	45	60	85	109	150	205	240	300
	<b>380-400V</b>	<b>A</b>	<b>16</b>	<b>30</b>	<b>45</b>	<b>60</b>	<b>85</b>	<b>109</b>	<b>150</b>	<b>205</b>	240	300
Rated operational power of three-phase motors 50-60Hz	415-440V	A	15	30	45	60	85	109	150	205	240	300
	500V	A	15	30	45	60	85	95	150	205	190	240
	660-690V	A	13	17	30	36	57	72	103	118	147	180
Rated operational power of three-phase motors 50-60Hz	220-230V	kW	4	7,5	11	15	22	30	45	55	75	90
	240V	kW	5,5	11	15	18,5	22	30	45	55	75	90
	<b>380-400V</b>	<b>kW</b>	<b>7,5</b>	<b>15</b>	<b>22</b>	<b>30</b>	<b>45</b>	<b>55</b>	<b>75</b>	<b>110</b>	<b>132</b>	<b>160</b>
Rated operational power of three-phase motors 50-60Hz	415-440V	kW	7,5	15	22	30	45	55	75	110	140	170
	500V	kW	7,5	18,5	30	37	55	75	90	132	132	180
	660-690V	kW	11	15	22	30	45	55	90	110	132	180
<b>Cable cross-sections</b>												
Line	solid or stranded	mm <sup>2</sup>	1,5 - 6 <sup>2)</sup>		1,5 - 16		10 - 70 <sup>3)</sup>		10 - 120		busbar	
	flexible	mm <sup>2</sup>	1,5 - 4 <sup>2)</sup>		1,5 - 16		16 - 50 <sup>3)</sup>		10 - 95		18x5	
	flexible with multicore cable end	mm <sup>2</sup>	1,5 - 4 <sup>2)</sup>		1,5 - 16		10 - 35		10 - 95		M8	
Motor	solid or stranded	mm <sup>2</sup>	1,5 - 6		1,5 - 16		4 - 35 <sup>3)</sup>		10 - 120		busbar	
	flexible	mm <sup>2</sup>	1,5 - 4		1,5 - 16		6 - 25 <sup>3)</sup>		10 - 95		18x5	
	flexible with multicore cable end	mm <sup>2</sup>	1,5 - 4		1,5 - 16		4 - 25		10 - 95		M8	
<b>Power consumption of the combination</b>												
inrush and change-over	VA		55		130		183		560		700	
	sealed VA		20		26		36		10		10	
	W		6		8		14		10		10	

## Coil Voltage Ranges and Non Standard Voltages for Star-Delta Starters

### K3NY15.. to K3Y100..

Suffix to Star-Delta Starter type e.g. K3Y80 <b>400</b>	Rated Control Voltage $U_s$			
	range for 50Hz		range for 60Hz	
	min. V	max. V	min. V	max. V
24	24	24	24	27
42	42	47	47	52
110	100	110	110	122
180	180	210	200	240
<b>230</b>	<b>220</b>	<b>240</b>	<b>230</b>	<b>264</b>
<b>400</b>	<b>380</b>	<b>415</b>	<b>400</b>	<b>415</b>

### K3Y140, to K3Y300..

Suffix to Star-Delta Starter type e.g. K3Y300 <b>230</b>	Rated Control Voltage $U_s$				
	range for 50Hz		range for 60Hz		for DC
	min. V	max. V	min. V	max. V	V
24	24	24	24	24	24
48	48	48	48	48	48
110	110	120	110	120	110
<b>230</b>	<b>220</b>	<b>240</b>	<b>220</b>	<b>240</b>	<b>220</b>
<b>400</b>	<b>380</b>	<b>415</b>	<b>380</b>	<b>415</b>	-

### Standard voltages in bold type letters

1) Suitable for: earthed-neutral systems, overvoltage category I to IV, pollution degree 3 (standard-industry):  $U_{imp} = 8kV$ .  
Data for other conditions on request.

2) Additional terminals see page 95

3) Maximum cable cross-section with prepared conductor

# Reversing Starters

Data according to IEC 947-4-1, VDE 0660, EN 60947-4-1

Type		K3NWU10	K3NWU18	K3WU24	K3WU32	K3WU50	K3WU62	K3WU74
<b>Main Contacts</b>								
Rated insulation voltage $U_i^{(1)}$	V AC	690	690	690	690	690	690	690
<b>Utilization category AC3</b>								
<b>Switching of three-phase motors</b>								
Rated operational current $I_e$	220V A	12	18	23	30	45	63	
	230V A	11,5	18	24	32	50	62	74
	240V A	11	18	24	32	50	62	74
	<b>380-400V A</b>	<b>10</b>	<b>18</b>	<b>24</b>	<b>32</b>	<b>50</b>	<b>62</b>	<b>74</b>
	415-440V A	9	18	23	30	50	62	74
	500V A	9	16	23	30	45	60	74
	660-690V A	6,5	8,5	17	20	31	40	40
Rated operational power of three-phase motors 50-60Hz	220-230V kW	3	5	6	8,5	12,5	18,5	
	240V kW	3	5	7	9	13,5	19	23
	<b>380-400V kW</b>	<b>4</b>	<b>7,5</b>	<b>11</b>	<b>15</b>	<b>22</b>	<b>30</b>	<b>37</b>
	415-440V kW	4,5	8,5	12	16	24	33	40
	500V kW	5,5	10	15	18,5	30	37	45
	660-690V kW	5,5	10	15	18,5	30	37	45
<b>Cable cross-sections</b>								
Line	solid or stranded	mm <sup>2</sup>	0,75 - 6		1,5 - 25		4 - 50	
	flexible	mm <sup>2</sup>	1 - 4		2,5 - 16		6 - 35	
	flexible with multicore cable end	mm <sup>2</sup>	0,75 - 4		1,5 - 16		6 - 35	
Cables per clamp			1		1		1	
<b>Power consumption of the combination</b>								
inrush and change-over sealed	VA	33 - 45		90 - 115		140 - 185		
	VA	7 - 10		9 - 13		13 - 18		
	W	2,6 - 3		2,7 - 4		5,4 - 7		

## Technical Data according to UL508

Main Contacts (cULus)	Type	KNW3-10	KNW3-18	KW3-24	KW3-32	KW3-40
Rated operational power of three-phase motors at 60Hz (3ph)	110-120V hp	1½	2	5	5	7½
	200V hp	3	5	7½	10	10
	220-240V hp	3	7½	10	10	15
	277V hp	3	7½	7½	10	15
	380-415V hp	5	10	10	15	20
	440-480V hp	5	10	15	20	25
	550-600V hp	7½	15	20	25	30
Fuse / Short-circuit current	A/kA	30/5	50/5	90/5	125/5	175/5
Rated voltage	V	600	600	600	600	600
<b>Auxiliary Contacts (cULus)</b>		A600	A600	A600	A600	A600
<b>Cable cross-sections</b>						
for main connectors	solid	AWG	18 - 10		16 - 10	
	flexible	AWG	18 - 10		14 - 4	
Cables per clamp			1		1	

1) Suitable for: earthed-neutral systems, overvoltage category I to IV, pollution degree 3 (standard-industry):  $U_{mp} = 8kV$ . Data for other conditions on request.

# Pole Changing Starters

Data according to IEC 947-4-1, VDE 0660, EN 60947-4-1

Type		K3NPU18	K3NPU24	K3PU32	K3PU50	K3PU62
<b>Main Contacts</b>						
Rated insulation voltage $U_i$ <sup>1)</sup>	V AC	690	690	690	690	690
<b>Utilization category AC3</b>						
<b>Switching of three-phase motors</b>						
Rated operational current $I_e$	220V A	18	23	30	45	63
	230V A	17,5	23	30	45	60
	240V A	17	23	30	45	60
	<b>380-400V A</b>	<b>16</b>	<b>23</b>	<b>30</b>	<b>45</b>	<b>60</b>
	415V A	16	23	30	45	60
	440V A	16	23	30	45	60
	500V A	16	23	30	45	55
	660V A	9	17,5	21	33	42
	690V A	8,5	17	20	31	40
Rated operational power of three-phase motors 50-60Hz	220-230V kW	5	6	8,5	12,5	18,5
	240V kW	5	7	9	13,5	19
	<b>380-400V kW</b>	<b>7,5</b>	<b>11</b>	<b>15</b>	<b>22</b>	<b>30</b>
	415-440V kW	8,5	12	16	24	33
	500V kW	10	15	18,5	30	37
	660-690V kW	7,5	15	18,5	30	37
<b>Cable cross-sections</b>						
Line	solid or stranded mm <sup>2</sup>	0,75 - 6	1,5 - 25		4 - 50	
	flexible mm <sup>2</sup>	1 - 4	2,5 - 16		6 - 35	
	flexible with multicore cable end mm <sup>2</sup>	0,75 - 4	1,5 - 16		6 - 35	
	Cables per clamp	1	1		1	
<b>Power consumption of the combination</b>						
	inrush and change-over VA	55	128		178	
	sealed VA	20	26		31	
	W	6	8		11	

1) Suitable for: earthed-neutral systems, overvoltage category I to IV, pollution degree 3 (standard-industry):  $U_{imp} = 8kV$ . Data for other conditions on request.

# Star-Delta Starters

## Wiring Diagrams Main Circuit

Terminal markings of contactors and relays according to DIN EN 50012  
Connections shown in main and circuits as broken lines are not included.

### K3NY15 to K3Y100

with thermal overload relay U3/.. or U12/16

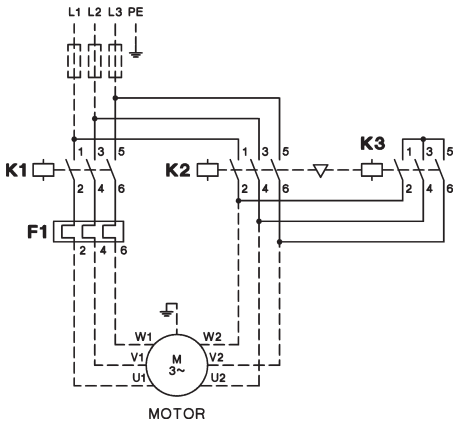

### K3Y140 to K3Y300

with thermal overload relay U85 or U180

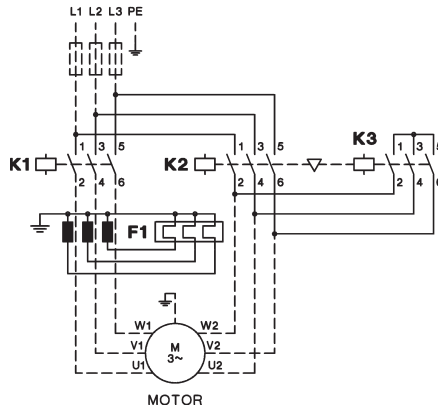

## Wiring Diagrams Control Circuit

### K3NY15 to K3Y52

operating with control switch

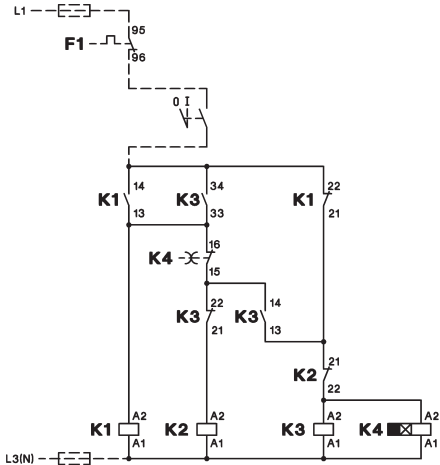

### K3NY15 to K3Y52

operating with push buttons

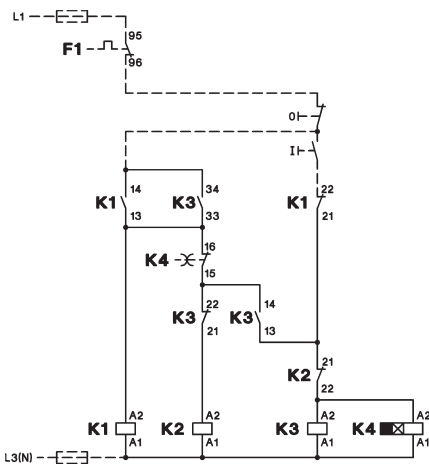

### K3Y80 to K3Y200

operating with control switch

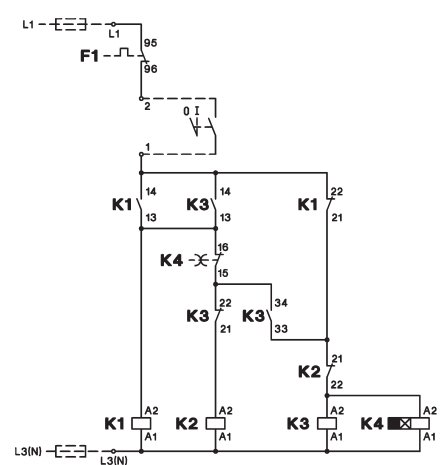

### K3Y80 to K3Y200

operating with push buttons

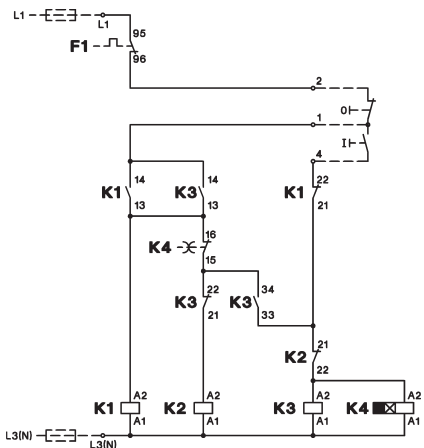

### K3Y240 to K3Y300

operating with control switch

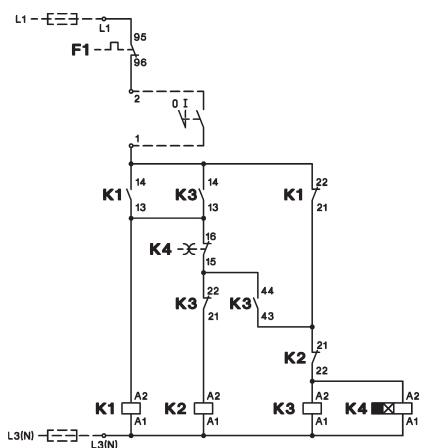

### K3Y240 to K3Y300

operating with push buttons

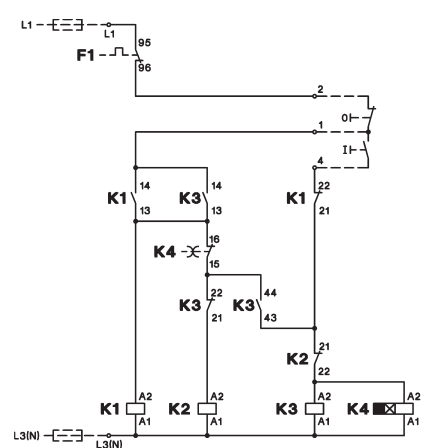

# Star-Delta Starters

## Wiring Diagrams Main Circuit

Terminal markings of contactors and relays according to DIN EN 50012  
 Connections shown in main and control circuits as broken lines are not included.

### K3YL..

Typical circuit diagram

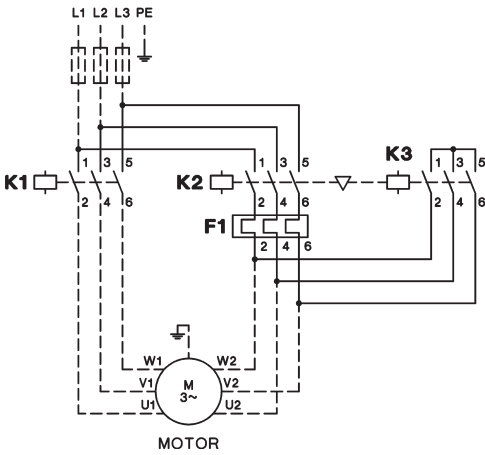

### K3Y.. with 2 Thermal Overload Relays

Typical circuit diagram

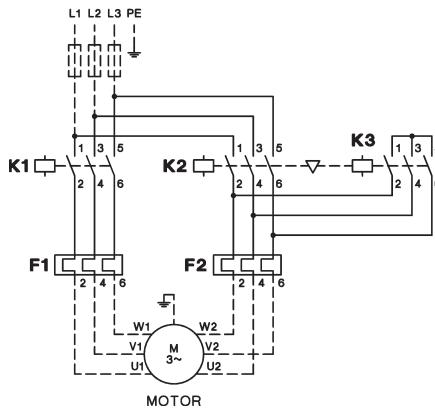

## Wiring Diagrams Control Circuit

### with selector switch

#### K3Y..W

Typical circuit diagram  
 operating with control switch

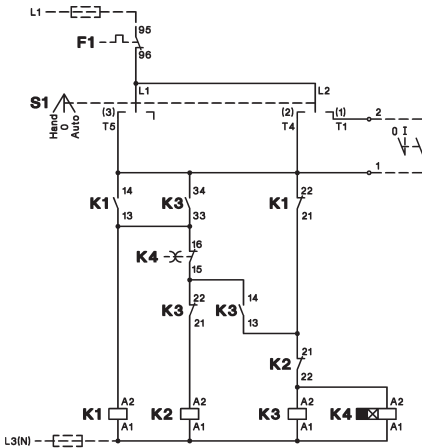

Typical circuit diagram  
 operating with push buttons

### with push buttons

#### K3Y..T

Typical circuit diagram

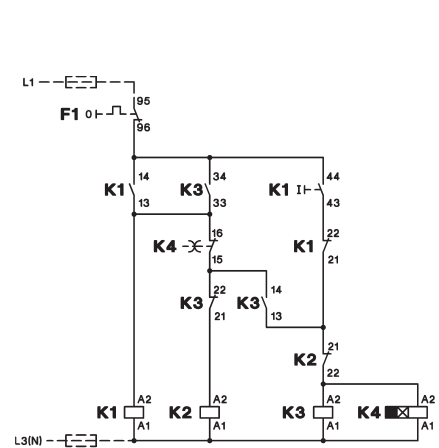
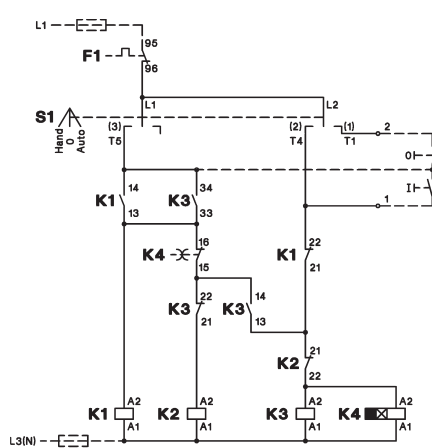

# Reversing Contactors

## Wiring Diagrams Main Circuit

Terminal markings of contactors and relays according to DIN EN 50012  
 Connections shown in main and control circuits as broken lines are not included.

### K3NWU10 to K3WU74

with thermal overload relay U3/32, U3/42 or U3/74

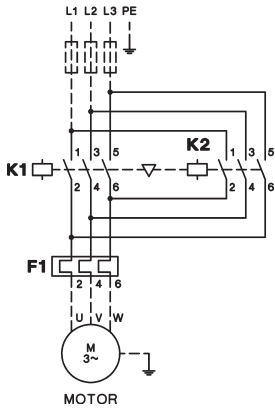

## Wiring Diagrams Control Circuit

### K3NWU10 to K3NWU18

operating with control switch

operating with push buttons  
**Reversing over off-position**

**Reversing direct**

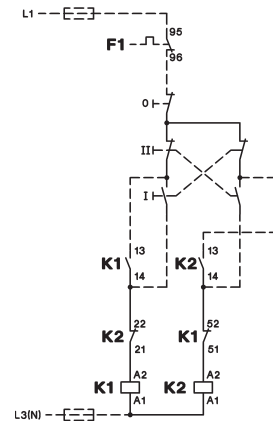
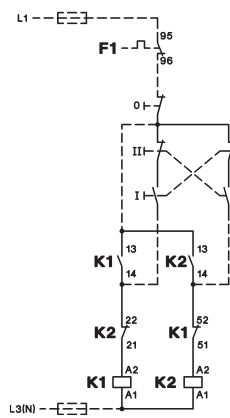
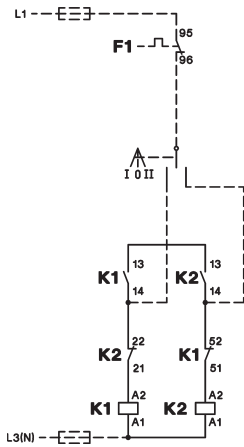

### K3WU24 to K3WU74

operating with control switch

operating with push buttons

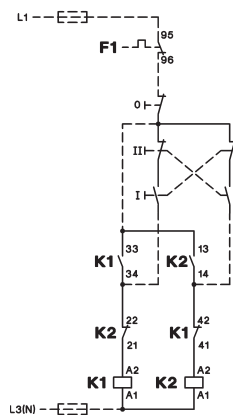
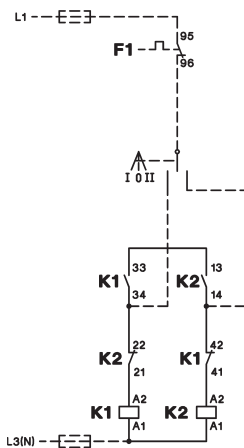

# Pole Changing Starters

## Wiring Diagrams

Terminal markings of contactors and relays according to DIN EN 50012  
 Connections shown in main and control circuits as broken lines are not included.

### Main Circuit

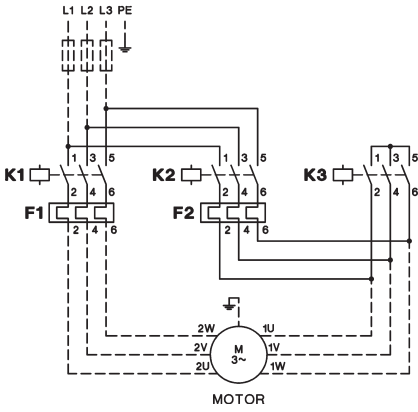

### Principal Control Circuit Wiring Diagram

operating with control switch

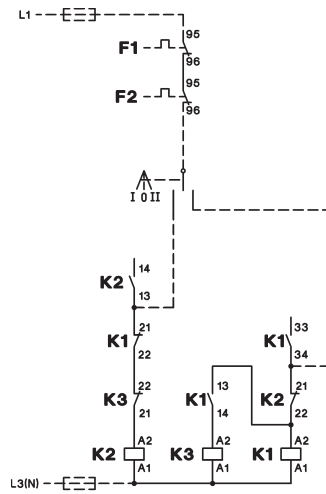

operating with push buttons

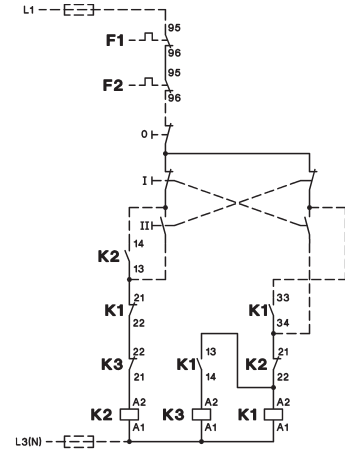

	Low speed	High speed	Low speed	High speed
Operation	Delta	Double-Star	Star	Double-Star
Speed relation	1	2	1	2
Power relation	1	1,5 - 1,8	0,3	1

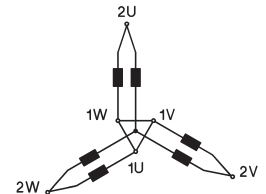
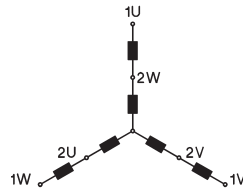
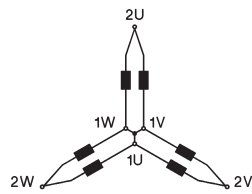
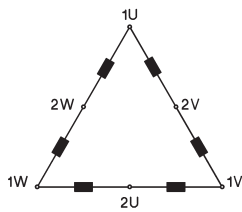

# Star-Delta Starters

## Dimensions

Star-Delta Starters, AC operated, open type

**K3NY15 + U3/32**  
**K3NY26**

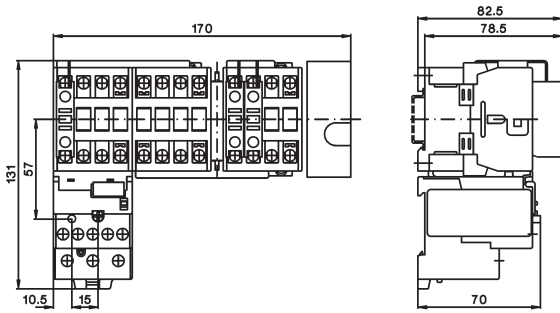

**K3NY15 + U12/16E G3**  
**K3NY26**

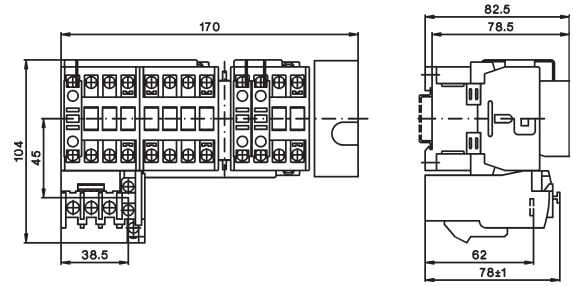

**K3Y40 + U3/32**  
**K3Y52 + U3/32**

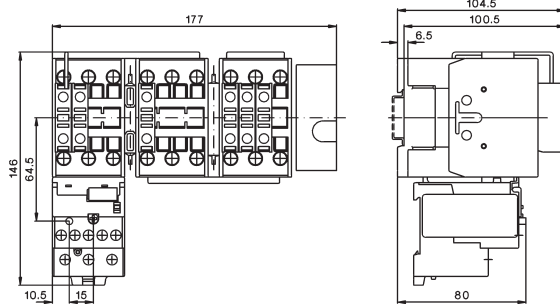

**K3Y40 + U3/42**  
**K3Y52 + U3/42**

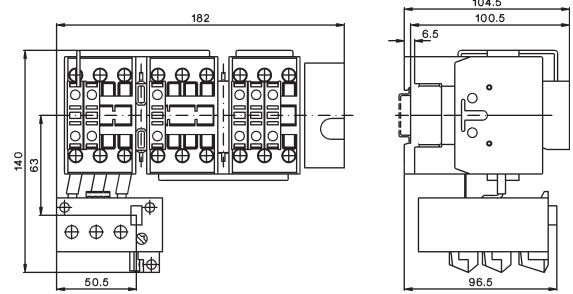

**K3Y80 + U3/74**

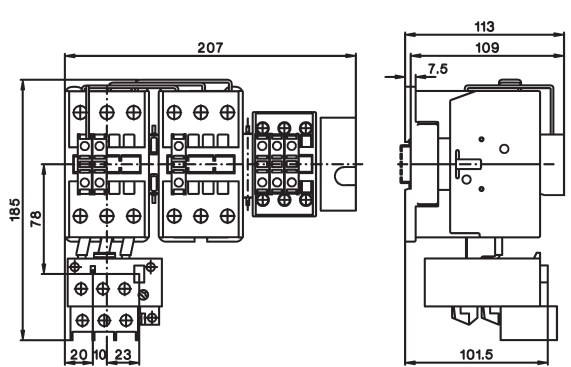

**K3Y100 + U3/74**

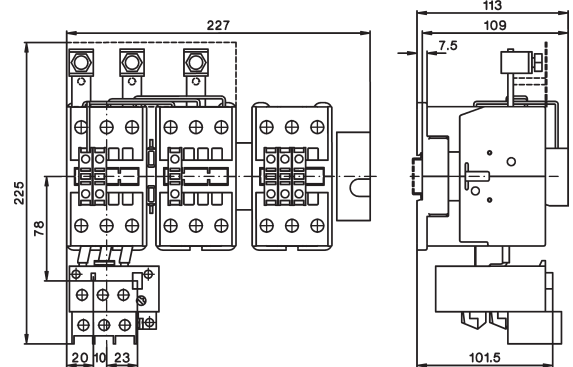

**K3Y140 + U85**  
**K3Y200**

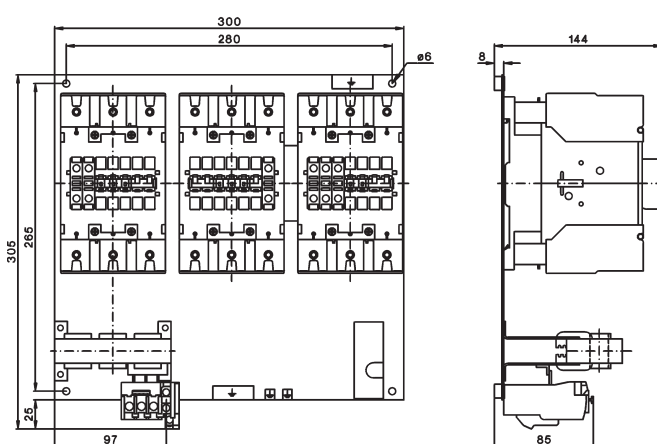

**K3Y240 + U180 + SU180/176**  
**K3Y300**

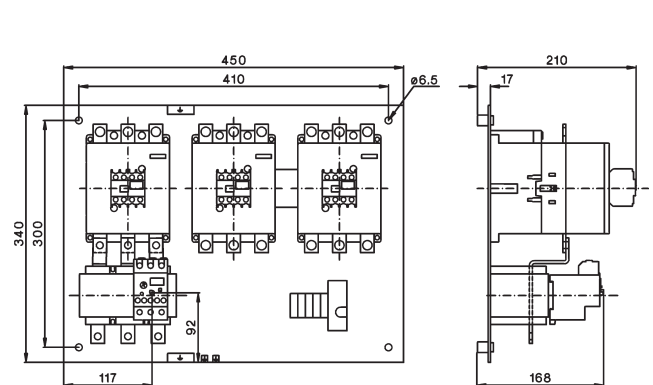

# Star-Delta Starters

## Dimensions

Star-Delta Starters, plastic enclosed, protected to IP65

### K3NY26P

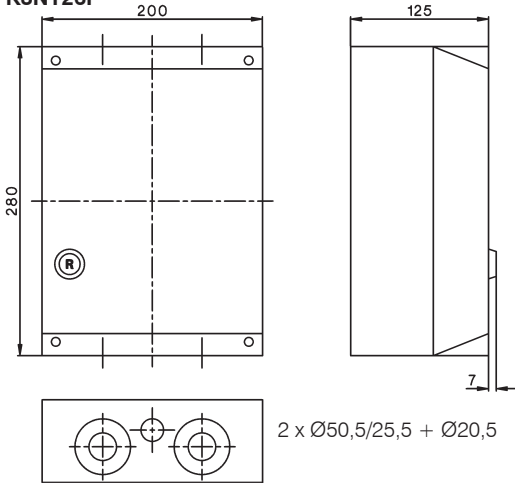

### K3Y40P to K2Y100P

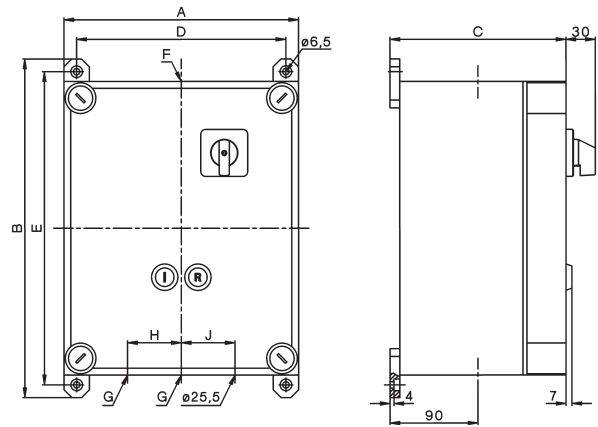

Type	A	B	C	D	E	Ø F	Ø G	H	J	
<b>K3Y40P</b>	300	346	180	272	320	6,5	32,5	32,5	60	60
<b>K3Y52P</b>	300	346	180	272	320	6,5	32,5	32,5	60	60
<b>K3Y80P</b>	300	446	180	272	420	6,5	40,5	40,5	70	70
<b>K3Y100P</b>	300	446	180	272	420	6,5	50,5	40,5	70	70

Star-Delta Starters, sheet steel enclosed, protected to IP54

### K3Y26B to K3Y52B

Type	Ø F	Ø G
<b>K3NY26B</b>	25,5	25,5
<b>K3Y40B</b>	32,5	32,5
<b>K3Y52B</b>	32,5	32,5

Mounting by included fixing link

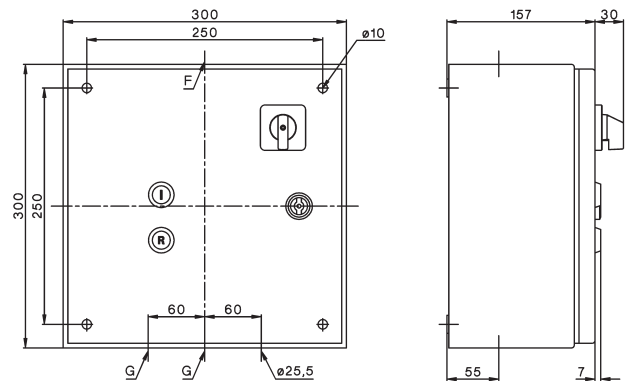
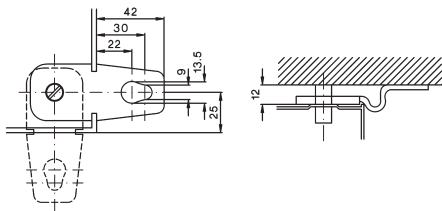

### K3Y80B to K2Y200B

Type	A	B	C	D	E	L	M
<b>K3Y80B</b>	380	380	210	340	340	8,7	65
<b>K3Y100B</b>	380	380	210	340	340	8,7	65
<b>K3Y140B</b>	380	600	210	560	340	8,7	65
<b>K3Y200B</b>	380	600	210	560	340	8,7	65

Type	Ø F	Ø G	H	J	K
<b>K3Y80B</b>	40,5	40,5	70	70	60
<b>K3Y100B</b>	50,5	40,5	80	70	60
<b>K3Y140B</b>	50,5	50,5	80	80	70
<b>K3Y200B</b>	50,5	50,5	80	80	70

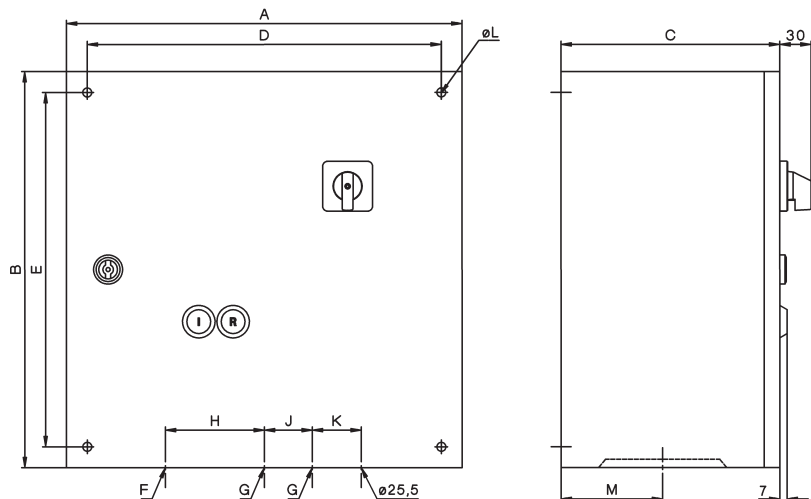

# Reversing Contactors

## Dimensions

Reversing Starters, AC operated, open type

**K3NWU10 + U3/32**  
**K3NWU18**

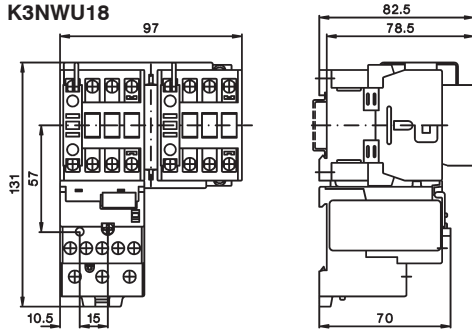

**K3NWU10 + U12/16E G3**  
**K3NWU18**

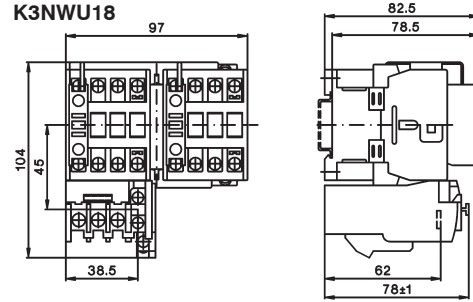

**K3WU24 + U3/32**  
**K3WU32**  
**K3WU40**

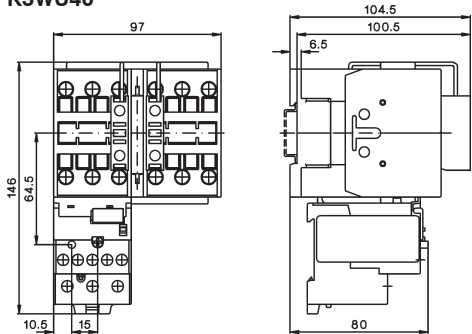

**K3WU24 + U3/42**  
**K3WU32**  
**K3WU40**

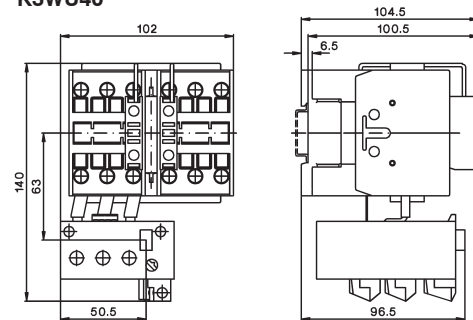

**K3WU50 + U3/74**  
**K3WU62**  
**K3WU74**

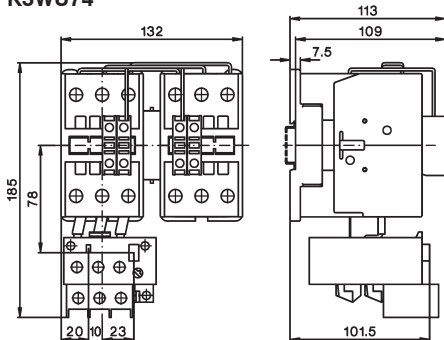

Reversing Contactors, sheet steel enclosed, protected to IP54

Type	A	B	C	D	E	F	G	H	K
<b>K3NWU18B</b>	300	300	150	250	250	30	30	Ø25,5	41
<b>K3WU24B</b>	300	300	150	250	250	30	30	Ø32,5	41
<b>K3WU32B</b>	300	300	150	250	250	30	30	Ø32,5	41
<b>K3WU50B</b>	300	300	150	250	250	40	40	Ø32,5	59
<b>K3WU62B</b>	300	300	150	250	250	40	40	Ø32,5	59

Mounting by included fixing link

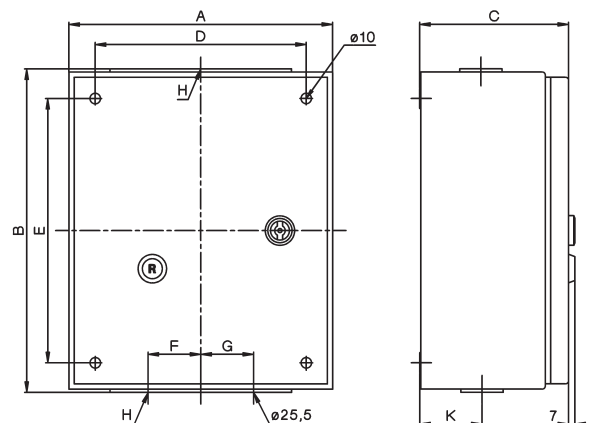
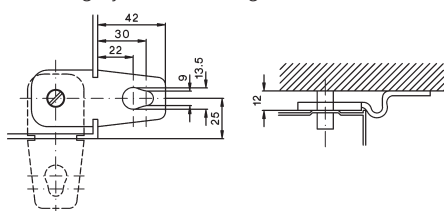

# Pole Changing Starters

## Dimensions

Pole Changing Starters, AC operated, open type

**K3NPU18 + 2x U3/32**

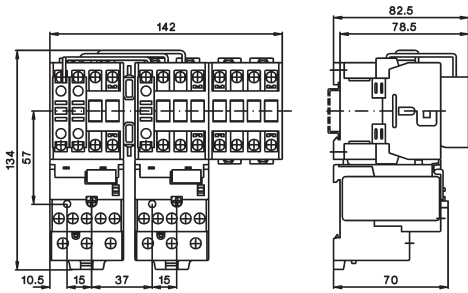

**K3NPU18 + 2x U12/16**

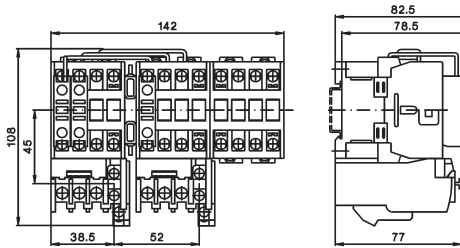

**K3PU24 + 2x U3/32  
K3PU32**

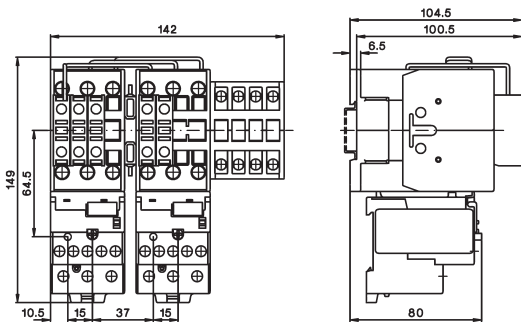

**K3PU50 + 2x U3/74  
K3PU62**

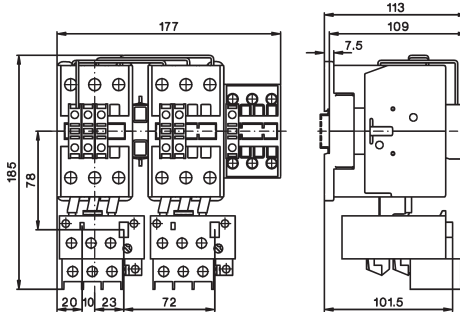

Pole Changing Starters, sheet steel enclosed, protected to IP54

**K3NPU18B to K3PU32B**

Type	Ø F	Ø G
<b>K3NPU18B</b>	25,5	25,5
<b>K3PU24B</b>	32,3	32,5
<b>K3PU32B</b>	32,3	32,5

Mounting by included fixing link

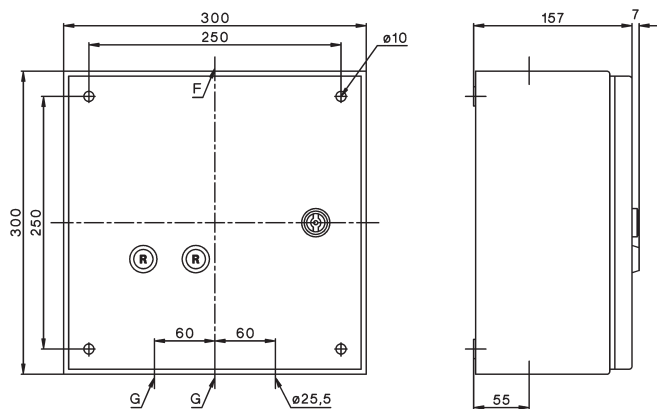
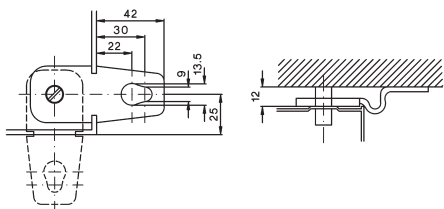



D.O.L. Starters With Start-Stop Buttons

112



D.O.L. Starters With Selector Switch

112



D.O.L. Starters With Selector Switch And Pneumatic Switch For Use In Moist Rooms

112



Enclosures

113

Accessories

113



Wiring Diagrams

115

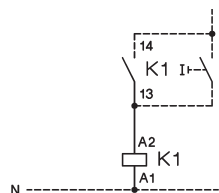

Dimensions

116

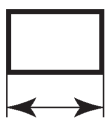

## D.O.L. Starters In Plastic Enclosure

Ratings	Included	Free	order	Protec-	Conduit	Type	Coil voltage <sup>1)</sup>	Pack	Weight
AC3 at	Contact	Space	extra	tion	Entries			pcs.	kg/pc.
<b>380V</b>		f. Aux.		Degree			<b>230</b> 220-240V 50Hz		
<b>400V</b>		Cont.	Overload				<b>400</b> 380-415V 50Hz		
<b>415V</b>	Type	HN..	Relay						
<b>kW</b>		pcs.	Type						

## D.O.L. Starters with Start-Stop/Reset Push Buttons



<b>4</b>	K3-10ND10	2	U12/16 K3	IP65	Ø 20,5mm	<b>P1T10</b> ...	1	0,6
<b>7,5</b>	K3-18ND10	2	U12/16 K3	IP65	Ø 20,5mm	<b>P1T18</b> ...	1	0,6
<b>11</b>	K3-22ND10	2	U12/16 K3	IP65	Ø 20,5mm	<b>P1T22</b> ...	1	0,6

## D.O.L. Starters with Selector Switch



<b>4</b>	K3-10ND10	2	U12/16 K3	IP65	Ø 20,5mm	<b>P1W10</b> ...	1	0,6
<b>7,5</b>	K3-18ND10	2	U12/16 K3	IP65	Ø 20,5mm	<b>P1W18</b> ...	1	0,6
<b>11</b>	K3-22ND10	2	U12/16 K3	IP65	Ø 20,5mm	<b>P1W22</b> ...	1	0,6

## D.O.L. Starters with Selector Switch and Pneumatic Switch for moist rooms



<b>7,5</b>	K3-18ND10	2	U12/16 K3	IP65	Ø 20,5mm	<b>P1W18P</b> ...	1	0,6
------------	-----------	---	-----------	------	----------	-------------------	---	-----

Push button and tube on request

**Ordering Example:** D.O.L. Starter with selector switch, plastic enclosed, rated AC3 at 400V 15,5A, rated control voltage 230V 50Hz - **Order Type: P1W18 230 + U12/16E 18 K3**

## Pneumatic Button



						<b>P1LT</b>	1	
--	--	--	--	--	--	-------------	---	--

## Air Pressure Hose



Length 5m						<b>P1LS-5</b>	1	
-----------	--	--	--	--	--	---------------	---	--

## Pneumatic Switch



for refill of D.O.L. Starter P1W.. to P1W..P						<b>P1-LDR</b>	1	0,02
--	--	--	--	--	--	---------------	---	------

## Thermal Overload Relays

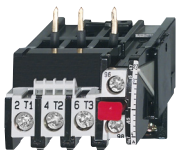

Setting range A	Type	Pack pcs.	Weight kg/pc.
0,12 - <b>0,18</b>	<b>U12/16E 0,18 K3</b>	1	0,10
0,18 - <b>0,27</b>	<b>U12/16E 0,27 K3</b>	1	0,10
0,27 - <b>0,4</b>	<b>U12/16E 0,4 K3</b>	1	0,10
0,4 - <b>0,6</b>	<b>U12/16E 0,6 K3</b>	1	0,10
0,6 - <b>0,9</b>	<b>U12/16E 0,9 K3</b>	1	0,10
0,8 - <b>1,2</b>	<b>U12/16E 1,2 K3</b>	1	0,10
1,2 - <b>1,8</b>	<b>U12/16E 1,8 K3</b>	1	0,10
1,8 - <b>2,7</b>	<b>U12/16E 2,7 K3</b>	1	0,10
2,7 - <b>4</b>	<b>U12/16E 4 K3</b>	1	0,10
4 - <b>6</b>	<b>U12/16E 6 K3</b>	1	0,10
6 - <b>9</b>	<b>U12/16E 9 K3</b>	1	0,10
8 - <b>11</b>	<b>U12/16E 11 K3</b>	1	0,10
10 - <b>14</b>	<b>U12/16E 14 K3</b>	1	0,10
13 - <b>18</b>	<b>U12/16E 18 K3</b>	1	0,10
17 - <b>23</b>	<b>U12/16E 23 K3</b>	1	0,10
22 - <b>30</b>	<b>U12/16E 30 K3</b>	1	0,13

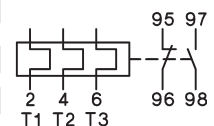

manual reset

## Overload Relays with Quick Tripping Characteristic see page 120,121

Technical data see contactors page 62 and thermal overload relays page 125  
1) Non-standard coil voltages see page 57

## Enclosures for Contactors



Suitable for contactor	Protection Degree	Conduit Entries Top	Conduit Entries Bottom	Type	Pack pcs.	Weight kg/pc.
<b>K3-07.. to K3-22.. K3-24..<sup>1)</sup> to K3-40..<sup>1)</sup></b>	IP65	2 x Ø 20,5mm	2 x Ø 20,5mm	<b>P1</b>	1	0,35

with Reset Button



Suitable for contactor	Protection Degree	Conduit Entries Top	Conduit Entries Bottom	Type	Pack pcs.	Weight kg/pc.
<b>K3-10.. to K3-22.. +U12/16.. K3</b>	IP65	2 x Ø 20,5mm	2 x Ø 20,5mm	<b>P1R</b>	1	0,35

with Selector Switch



Suitable for contactor	Protection Degree	Conduit Entries Top	Conduit Entries Bottom	Type	Pack pcs.	Weight kg/pc.
<b>K3-10.. to K3-22.. +U12/16.. K3</b>	IP65	2 x Ø 20,5mm	2 x Ø 20,5mm	<b>P1W</b>	1	0,35

with Start-Stop Push Button



Suitable for contactor	Protection Degree	Conduit Entries Top	Conduit Entries Bottom	Type	Pack pcs.	Weight kg/pc.
<b>K3-10.. to K3-22.. +U12/16.. K3</b>	IP65	2 x Ø 20,5mm	2 x Ø 20,5mm	<b>P1T</b>	1	0,35

## Heating Element



Specifications	Voltage Range	Power Consumption	Type	Pack pcs.	Weight kg/pc.
To avoid condensed water on places where high humidity is given together with alterations of ambient temperature	380 - 415V,	1,5W	<b>K2-HR</b>	10	0,02
	220 - 240V,	1,5W	<b>K2-HR 230</b>	10	0,02

## Additional Terminals, Start Contact



Specification	Cable Cross-sections to clamp solid or stranded	flexible	flexib. w. multi-core cable end	Type	Pack pcs.	Weight kg/pc.
<b>Neutral Terminal</b>	2 x 0,75-4	2 x 0,75-2,5	2 x 0,5-2,5	<b>LG9744</b>	10	0,009



<b>Start Contact</b>	for contactor K3-10 to K3-22	to be snapped on top of the auxiliary contact	<b>LG9319-K3</b>	10	0,03
----------------------	------------------------------	---	------------------	----	------

1) without auxiliary contact blocks

# D.O.L. Starters

## Wiring Diagrams Main Circuit

All fuses F0 shown in the main circuits are not included.  
Terminal markings according to EN 50012

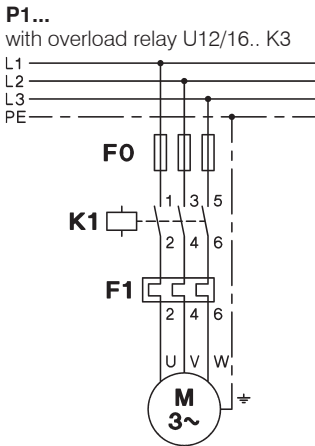

## Wiring for single phase motors

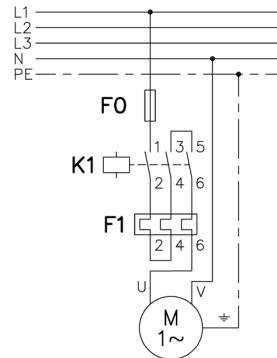

## Wiring Diagrams Control Circuit

D.O.L. Starters P1 with standard coil voltages (see page 94) are supplied with connectors between main circuit and control circuit.

### Coil connectors

Coils for **380-415V 50Hz** and **400-440V 60Hz**: The starter is supplied with control circuit connectors between terminals 1 (L1) and 5 (L3).  
Coils for **220-240V 50Hz** and **230-264V 60Hz**: The starter is supplied with control circuit connectors between terminals 95 and 5 (L3). Connect neutral wire to terminal A1.  
Coils for **other voltages**: Without connectors between supply and control circuit. Connect supply to terminals A1 and 95.

### Separate coil supply

Coils for **380-415V 50Hz** and **400-440V 60Hz**: Remove connectors A1-1 and 95-5, connect supply to terminals A1 and 95.  
Coils for **220-240V 50Hz** and **230-264V 60Hz**: Remove connectors 95-5 connect supply to terminals A1 and 95.  
Coils for **other voltages**: Connect supply to terminals A1 and 95.

### Coil phase to phase (380-415V 50Hz)

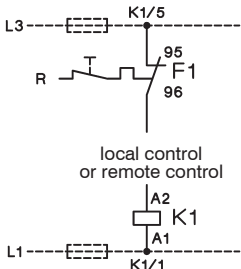

### Coil phase to neutral (220-240V 50Hz)

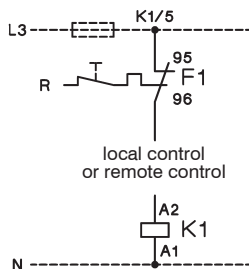

### Coil phase to phase

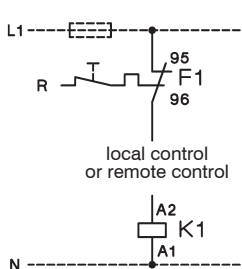

### Coil phase to neutral

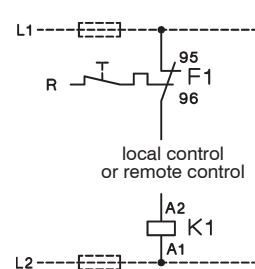

## D.O.L. Starters with remote control

**P1..**  
Remote 2-wire (switch) control

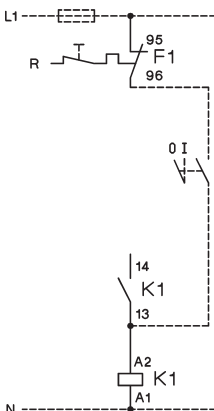

Remote 3-wire (push button) control

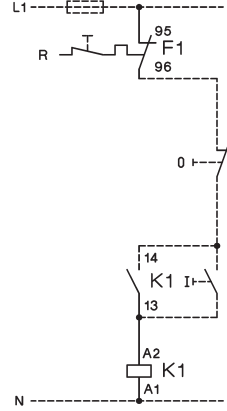

Remote start-stop control  
(3 control stations)

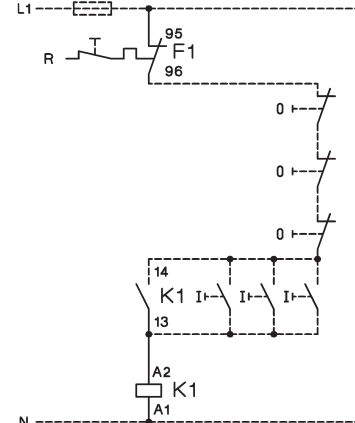

# D.O.L. Starters

## Wiring Diagrams Control Circuits

Typical circuit diagram (for separate coil supply, control circuit connected between L1 and N)  
Terminal markings according to EN 50012

### D.O.L. Starters with Start-Stop/Reset Push Buttons

**P1T10, P1T18, P1T22**  
with overload relay U12/16.. K3

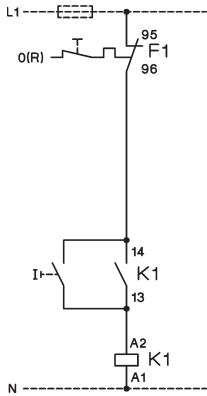

**P1T10, P1T18, P1T22**  
with external push buttons

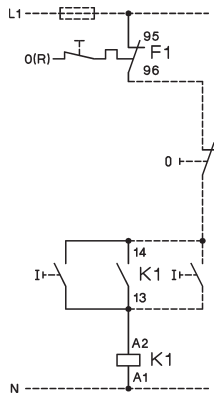

### D.O.L. Starters with Selector Switch

**P1W10, P1W18, P1W22**  
with external control switch

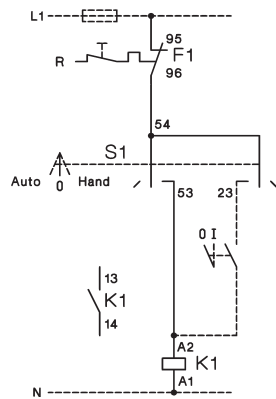

**P1W10, P1W18, P1W22**  
with external push buttons

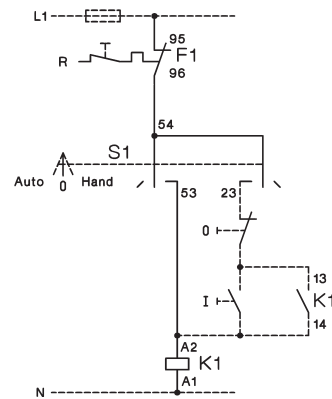

### D.O.L. Starters with Selector Switch and Pneumatic Switch for Swimmingpool Control Gear and for use in Moist Rooms

**P1W18P**  
with overload relay U12/16.. K3

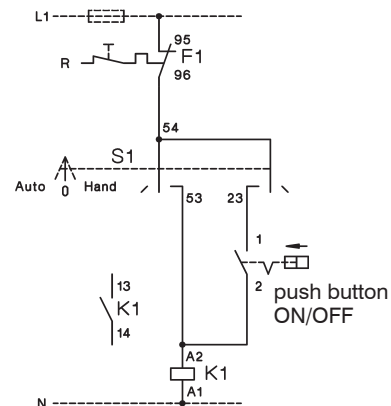

# D.O.L. Starters

## Dimensions

D.O.L. Starters with Start-Stop/Reset Push Buttons, Plastic Enclosed

P1T., P1TP.

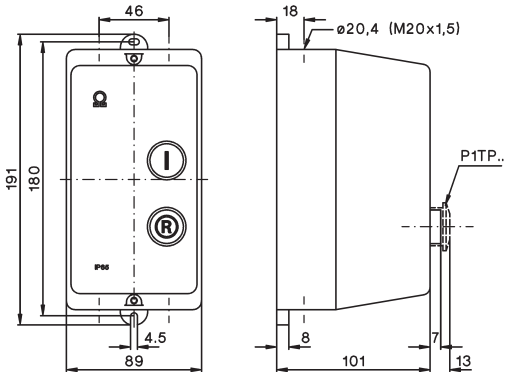

D.O.L. Starters with Selector Switch, Plastic Enclosed

P1W., P1W18P

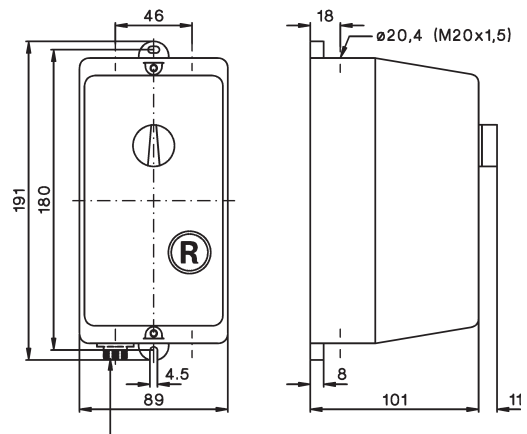

P1W18P: plug-in for air tube inside diameter 3mm

## Rear Conduit Entries

knockouts  
4 x  $\varnothing 23$

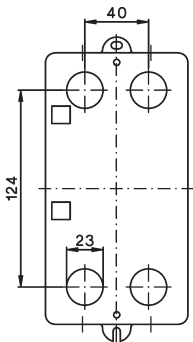

## Neutral Terminal LG9744

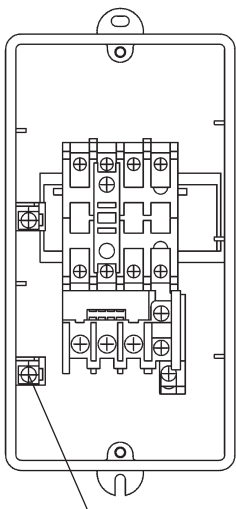

LG9744

# Enclosures

## Dimensions

### Enclosures for Contactors

P1

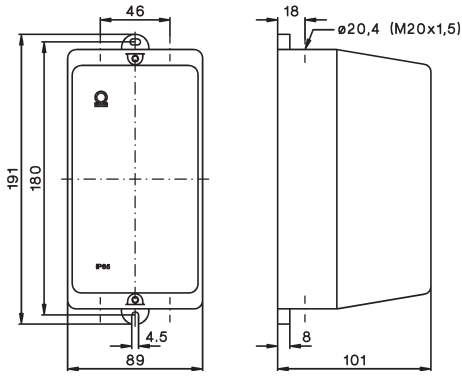

### Enclosures for D.O.L. Starters

P1R, P1P

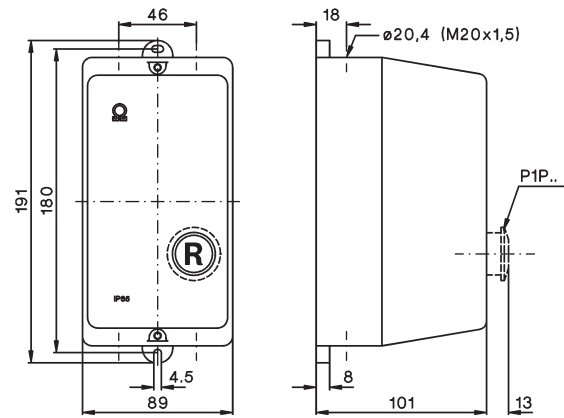

### Rear Conduit Entries

knockouts  
4 x  $\phi 23$

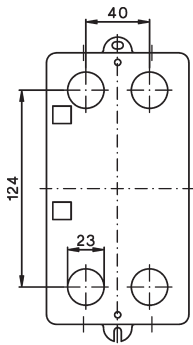

# D.O.L. Starters

## Mounting and Wiring Instructions

Indicators and Lens Caps for D.O.L. Starters P1

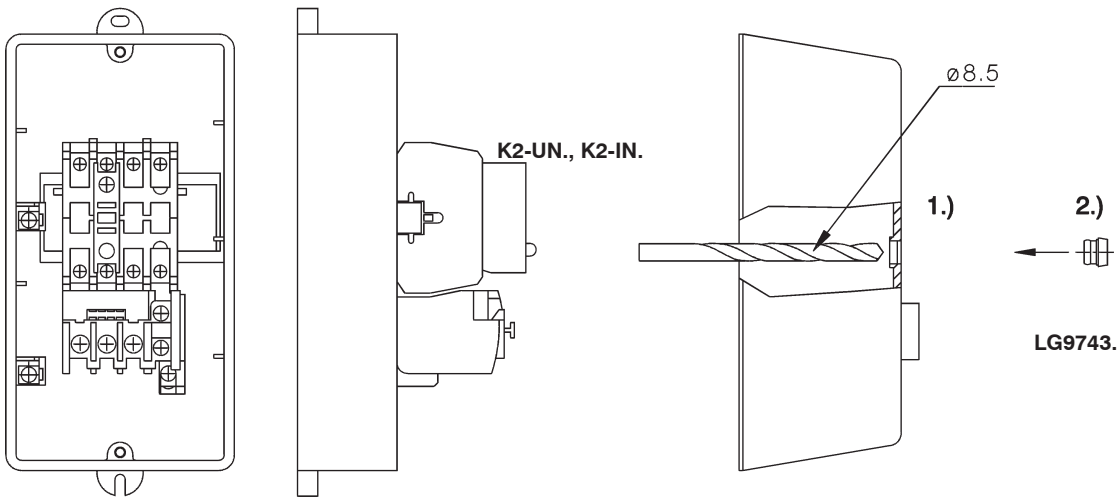

### Wiring Examples

#### Coil Current Indicator

K2-ING  
K2-INR

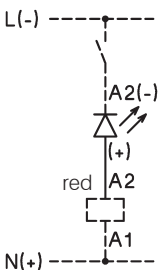

#### Voltage Indicator

K2-UN  
K2-UNR

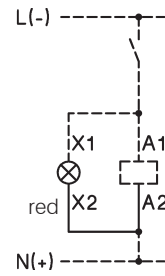

#### Heating Element

K2-HR

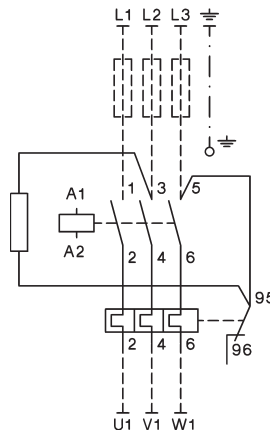

K2-HR 230

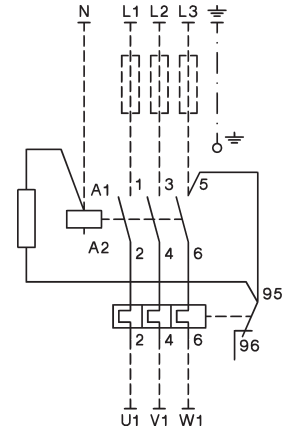

Colour mentioned in wiring diagrams refer to the outgoing connection wire of the device.

Start Contact LG9319-K3 for K3-10ND10 up to K3-22ND10

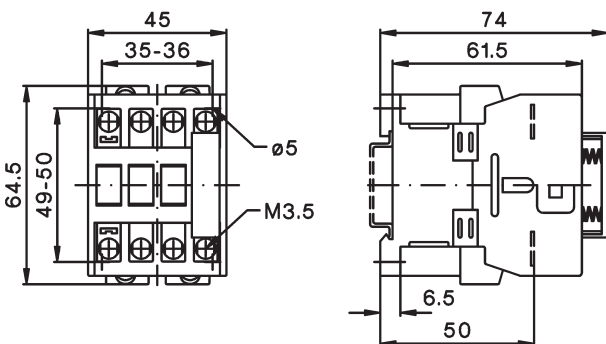



Thermal Overload Relays for Direct Mounting

120

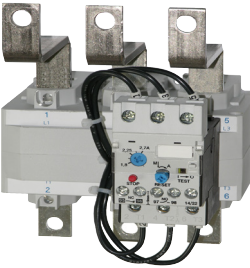

Thermal Overload Relays for Separate Mounting

122



Accessories

123



Technical Data

125

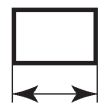

Dimensions

129

# Thermal Overload Relays for plug-in mounting

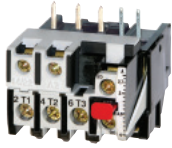

Setting Range			Type	Pack pcs.	Weight kg/pc.	Wiring Diagram
D.O.L. (A)	$\Upsilon\Delta$ (A)					
<b>With Manual Reset</b> , for contactors K1-..						
0,12 - <b>0,18</b>	-		<b>U12/16E 0,18 K1</b>	1	0,10	<p>95 97 2 4 6 96 98 T1 T2 T3 manual reset</p>
0,18 - <b>0,27</b>	-		<b>U12/16E 0,27 K1</b>	1	0,10	
0,27 - <b>0,4</b>	-		<b>U12/16E 0,4 K1</b>	1	0,10	
0,4 - <b>0,6</b>	-		<b>U12/16E 0,6 K1</b>	1	0,10	
0,6 - <b>0,9</b>	-		<b>U12/16E 0,9 K1</b>	1	0,10	
0,8 - <b>1,2</b>	-		<b>U12/16E 1,2 K1</b>	1	0,10	
1,2 - <b>1,8</b>	-		<b>U12/16E 1,8 K1</b>	1	0,10	
1,8 - <b>2,7</b>	-		<b>U12/16E 2,7 K1</b>	1	0,10	
2,7 - <b>4</b>	-		<b>U12/16E 4 K1</b>	1	0,10	
4 - <b>6</b>	7 - 10,5		<b>U12/16E 6 K1</b>	1	0,10	
6 - <b>9</b>	10,5 - 15,5		<b>U12/16E 9 K1</b>	1	0,10	
8 - <b>11</b>	14 - 19		<b>U12/16E 11 K1</b>	1	0,10	
10 - <b>14</b>	18 - 24		<b>U12/16E 14 K1</b>	1	0,10	

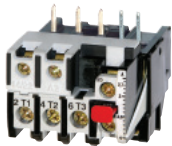

<b>With Auto Reset</b> , for contactors K1-..						
0,12 - <b>0,18</b>	-		<b>U12/16A 0,18 K1</b>	1	0,10	<p>95 2 4 6 98 96 T1 T2 T3 auto reset or manual reset</p>
0,18 - <b>0,27</b>	-		<b>U12/16A 0,27 K1</b>	1	0,10	
0,27 - <b>0,4</b>	-		<b>U12/16A 0,4 K1</b>	1	0,10	
0,4 - <b>0,6</b>	-		<b>U12/16A 0,6 K1</b>	1	0,10	
0,6 - <b>0,9</b>	-		<b>U12/16A 0,9 K1</b>	1	0,10	
0,8 - <b>1,2</b>	-		<b>U12/16A 1,2 K1</b>	1	0,10	
1,2 - <b>1,8</b>	-		<b>U12/16A 1,8 K1</b>	1	0,10	
1,8 - <b>2,7</b>	-		<b>U12/16A 2,7 K1</b>	1	0,10	
2,7 - <b>4</b>	-		<b>U12/16A 4 K1</b>	1	0,10	
4 - <b>6</b>	7 - 10,5		<b>U12/16A 6 K1</b>	1	0,10	
6 - <b>9</b>	10,5 - 15,5		<b>U12/16A 9 K1</b>	1	0,10	
8 - <b>11</b>	14 - 19		<b>U12/16A 11 K1</b>	1	0,10	
10 - <b>14</b>	18 - 24		<b>U12/16A 14 K1</b>	1	0,10	

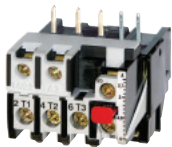

<b>With Quick Tripping Characteristic</b> for EEx e motors and submersible pumps, f. contactors K1-..						
0,4 - <b>0,6</b>	-		<b>U12/16EQ 0,6 K1</b>	1	0,10	<p>95 97 2 4 6 96 98 T1 T2 T3 manual reset</p>
0,6 - <b>0,9</b>	-		<b>U12/16EQ 0,9 K1</b>	1	0,10	
0,8 - <b>1,2</b>	-		<b>U12/16EQ 1,2 K1</b>	1	0,10	
1,2 - <b>1,8</b>	-		<b>U12/16EQ 1,8 K1</b>	1	0,10	
1,8 - <b>2,7</b>	-		<b>U12/16EQ 2,7 K1</b>	1	0,10	
2,7 - <b>4</b>	-		<b>U12/16EQ 4 K1</b>	1	0,10	
4 - <b>6</b>	7 - 10,5		<b>U12/16EQ 6 K1</b>	1	0,10	
6 - <b>9</b>	10,5 - 15,5		<b>U12/16EQ 9 K1</b>	1	0,10	
8 - <b>11</b>	14 - 19		<b>U12/16EQ 11 K1</b>	1	0,10	

# Thermal Overload Relays for plug-in mounting

Contactors, Motor-Starters  
 Circuit Breakers  
 Manual Motor-Starters  
 Switches  
 AC-Main Switches  
 DC-Switch Disconnectors  
 Push Buttons  
 Representatives, Suppliers

Setting Range Type Pack Weight Wiring Diagram  
 D.O.L. (A)  $\Upsilon\Delta$  (A) pcs. kg/pc.

**With Manual Reset**, for contactors K(G)3-10.. to K(G)3-22.. ..

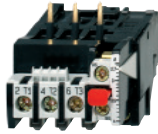

0,12 - <b>0,18</b>	-		<b>U12/16E 0,18 K3</b>	1	0,10
0,18 - <b>0,27</b>	-		<b>U12/16E 0,27 K3</b>	1	0,10
0,27 - <b>0,4</b>	-		<b>U12/16E 0,4 K3</b>	1	0,10
0,4 - <b>0,6</b>	-		<b>U12/16E 0,6 K3</b>	1	0,10
0,6 - <b>0,9</b>	-		<b>U12/16E 0,9 K3</b>	1	0,10
0,8 - <b>1,2</b>	-		<b>U12/16E 1,2 K3</b>	1	0,10
1,2 - <b>1,8</b>	-		<b>U12/16E 1,8 K3</b>	1	0,10
1,8 - <b>2,7</b>	-		<b>U12/16E 2,7 K3</b>	1	0,10
2,7 - <b>4</b>	-		<b>U12/16E 4 K3</b>	1	0,10
4 - <b>6</b>	7 - 10,5		<b>U12/16E 6 K3</b>	1	0,10
6 - <b>9</b>	10,5 - 15,5		<b>U12/16E 9 K3</b>	1	0,10
8 - <b>11</b>	14 - 19		<b>U12/16E 11 K3</b>	1	0,10
10 - <b>14</b>	18 - 24		<b>U12/16E 14 K3</b>	1	0,10
13 - <b>18</b>	23 - 31		<b>U12/16E 18 K3</b>	1	0,10
17 - <b>23</b>	30 - 40		<b>U12/16E 23 K3</b>	1	0,10
22 - <b>30</b>	38 - 52		<b>U12/16E 30 K3</b>	1	0,13

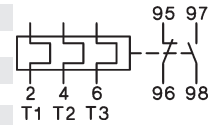

manual reset

**With quick Tripping Characteristic** for EEx e motors and under water pumps

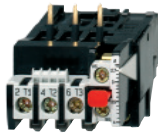

0,4 - <b>0,6</b>	-		<b>U12/16EQ 0,6 K3</b>	1	0,10
0,6 - <b>0,9</b>	-		<b>U12/16EQ 0,9 K3</b>	1	0,10
0,8 - <b>1,2</b>	-		<b>U12/16EQ 1,2 K3</b>	1	0,10
1,2 - <b>1,8</b>	-		<b>U12/16EQ 1,8 K3</b>	1	0,10
1,8 - <b>2,7</b>	-		<b>U12/16EQ 2,7 K3</b>	1	0,10
2,7 - <b>4</b>	-		<b>U12/16EQ 4 K3</b>	1	0,10
4 - <b>6</b>	7 - 10,5		<b>U12/16EQ 6 K3</b>	1	0,10
6 - <b>9</b>	10,5 - 15,5		<b>U12/16EQ 9 K3</b>	1	0,10
8 - <b>11</b>	14 - 19		<b>U12/16EQ 11 K3</b>	1	0,10
10 - <b>14</b>	18 - 24		<b>U12/16EQ 14 K3</b>	1	0,10

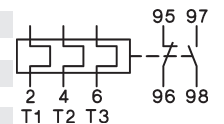

manual reset

For contactors K(G)3-10.. to K(G)3-40A..



0,12 - <b>0,18</b>	-		<b>U3/32 0,18</b>	1	0,14
0,18 - <b>0,27</b>	-		<b>U3/32 0,27</b>	1	0,14
0,27 - <b>0,4</b>	-		<b>U3/32 0,4</b>	1	0,14
0,4 - <b>0,6</b>	-		<b>U3/32 0,6</b>	1	0,14
0,6 - <b>0,9</b>	-		<b>U3/32 0,9</b>	1	0,14
0,8 - <b>1,2</b>	-		<b>U3/32 1,2</b>	1	0,14
1,2 - <b>1,8</b>	-		<b>U3/32 1,8</b>	1	0,14
1,8 - <b>2,7</b>	-		<b>U3/32 2,7</b>	1	0,14
2,7 - <b>4</b>	-		<b>U3/32 4</b>	1	0,14
4 - <b>6</b>	7 - 10,5		<b>U3/32 6</b>	1	0,14
6 - <b>9</b>	10,5 - 15,5		<b>U3/32 9</b>	1	0,14
8 - <b>11</b>	14 - 19		<b>U3/32 11</b>	1	0,14
10 - <b>14</b>	18 - 24		<b>U3/32 14</b>	1	0,14
13 - <b>18</b>	23 - 31		<b>U3/32 18</b>	1	0,14
17 - <b>24</b>	30 - 41		<b>U3/32 24</b>	1	0,14
23 - <b>32</b>	40 - 55		<b>U3/32 32</b>	1	0,14

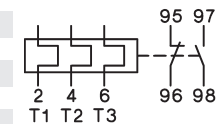

manual and auto reset

For contactors K(G)3-24A.. to K(G)3-40A ..



10 - <b>14</b>	18 - 24		<b>U3/42 14</b>	1	0,30
14 - <b>20</b>	24 - 35		<b>U3/42 20</b>	1	0,30
20 - <b>28</b>	35 - 48		<b>U3/42 28</b>	1	0,30
28 - <b>42</b>	48 - 73		<b>U3/42 42</b>	1	0,30

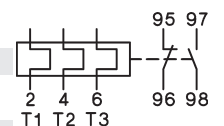

manual and auto reset

## Thermal Overload Relays for plug-in mounting



**Setting Range**  
D.O.L. (A)  $\Delta$  (A)

For contactors K3-50A.. to K3-74A..

Setting Range	D.O.L. (A)	$\Delta$ (A)	Type	Pack pcs.	Weight kg/pc.
20 - <b>28</b>	35 - 48		<b>U3/74 28</b>	1	0,40
28 - <b>42</b>	48 - 73		<b>U3/74 42</b>	1	0,40
40 - <b>52</b>	70 - 90		<b>U3/74 52</b>	1	0,40
52 - <b>65</b>	90 - 112		<b>U3/74 65</b>	1	0,40
60 - <b>74</b>	104 - 128		<b>U3/74 74</b>	1	0,40

Wiring Diagram

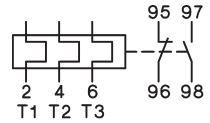

manual and auto reset

## Thermal Overload Relays for separate mounting

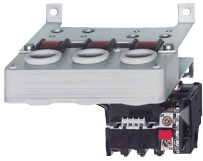

**Setting Range**  
D.O.L. (A)  $\Delta$  (A)

For contactors K3-90, K3-115, K85, K110

Setting Range	D.O.L. (A)	$\Delta$ (A)	Type	Pack pcs.	Weight kg/pc.
60 - <b>90</b>	104 - 156		<b>U85 90</b>	1	0,90
80 - <b>120</b>	140 - 207		<b>U85 120</b>		

Wiring Diagram

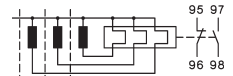

manual reset



For contactors K3-151.. and K3-176.., busbars included

Setting Range	D.O.L. (A)	$\Delta$ (A)	Type	Pack pcs.	Weight kg/pc.
120 - <b>180</b>	208 - 312		<b>U180 180</b>	1	1,5

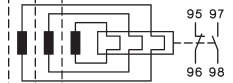

manual and auto reset



For contactors K3-210.. up to K3-316.., busbars included

Setting Range	D.O.L. (A)	$\Delta$ (A)	Type	Pack pcs.	Weight kg/pc.
144 - <b>216</b>	250 - 374		<b>U320 216</b>	1	1,8
216 - <b>320</b>	374 - 554		<b>U320 320</b>		

manual and auto reset

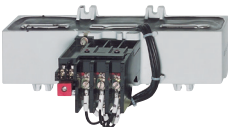

For contactors K3-315.. , K3-450.. , K3-550.. , K3-700.. , K3-860..

Setting Range	D.O.L. (A)	$\Delta$ (A)	Type	Pack pcs.	Weight kg/pc.
240 - <b>360</b>	416 - 623		<b>U800 360</b>	1	4,1
360 - <b>540</b>	623 - 935		<b>U800 540</b>	1	4,1
540 - <b>800</b>	935 - 1385		<b>U800 800</b>	1	4,1

## Accessories

for overload relays      for contactors

Type

Pack set      Weight kg/set



### Busbar Sets

U800	K3-450.., K3-550..	<b>SU840/550</b>	1	1,7
U800	K3-700.., K3-860..	<b>SU840/860</b>	1	2,1

Cable Cross-section (mm<sup>2</sup>)      Type

overload relay      solid or      flexible

stranded

Pack pcs.      Weight kg/pc.

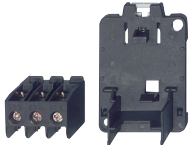

### for Single Mounting U12/16..K3 Base for DIN-rail mounting plus terminals

U12/16..K3	0,75 - 6	0,75 - 4	<b>U12SM K3</b>	1	0,035
------------	----------	----------	-----------------	---	-------

### for Single Mounting U3/32 Additional Terminals with fingertouch protection (U3/32 relays have base for DIN rail mounting integrated)



U3/32	0,75 - 6	0,75 - 4	<b>U3/32SM</b>	1	0,035
-------	----------	----------	----------------	---	-------

### for Single Mounting U3/42 or U3/74 Base for DIN-rail mounting



U3/42, U3/74	-	-	<b>U3/42G</b>	1	0,030
--------------	---	---	---------------	---	-------

### for Single Mounting U3/42 or U3/74 Connecting Wire Set (3 pcs.)



U3/42, U3/74	150mm length	10mm <sup>2</sup>	<b>LG5830-4</b>	1	0,060
U3/42, U3/74	250mm length	10mm <sup>2</sup>	<b>LG5830-2</b>	1	0,100

### Additional Terminals with fingertouch protection



1-pole f. U12/16, U3/32	0,75 - 10	0,75 - 6	<b>LG9339</b>	1	0,009
-------------------------	-----------	----------	---------------	---	-------

3-pole for U3/42	4 - 35	6 - 25	<b>LG7559</b>	1	0,052
------------------	--------	--------	---------------	---	-------

# Thermal Overload Relays, tripping times for selection to motors of protection degree EEx e

## Relays With Standard Tripping Characteristic

**Setting Range** Tripping time depending on the multiple of the current setting from cold condition (tolerance  $\pm 20\%$  of the tripping time)

A	A	I <sub>A</sub> /I <sub>N</sub> 3	I <sub>A</sub> /I <sub>N</sub> 4	I <sub>A</sub> /I <sub>N</sub> 5	I <sub>A</sub> /I <sub>N</sub> 6	I <sub>A</sub> /I <sub>N</sub> 7,2	I <sub>A</sub> /I <sub>N</sub> 8
<b>U3/32 ..</b>							
		s	s	s	s	s	s
0,12 -	<b>0,18</b>	16,1	9,6	6,8	5,3	4,2	3,7
0,18 -	<b>0,27</b>	16,6	9,7	6,7	5,2	4,1	3,6
0,27 -	<b>0,4</b>	19,4	11,4	7,9	6,1	4,7	4,2
0,4 -	<b>0,6</b>	18,7	10,9	7,6	5,9	4,6	4,0
0,6 -	<b>0,9</b>	19,2	11,2	7,7	5,9	4,6	4,1
0,8 -	<b>1,2</b>	20,8	12,3	8,5	6,6	5,2	4,6
1,2 -	<b>1,8</b>	25,5	14,1	9,8	7,6	5,9	5,2
1,8 -	<b>2,7</b>	26,6	15,6	10,9	8,3	6,5	5,7
2,7 -	<b>4</b>	22,7	13,6	9,5	7,4	5,8	5,1
4 -	<b>6</b>	22,2	13,3	9,3	7,1	5,6	4,9
6 -	<b>9</b>	20,4	11,9	8,2	6,1	4,7	4,0
8 -	<b>11</b>	20,9	11,8	7,9	5,7	4,3	3,5
10 -	<b>14</b>	21,3	11,7	7,4	5,1	3,7	3,0
13 -	<b>18</b>	21,2	12,1	8,0	6,2	4,6	4,1
17 -	<b>24</b>	20,4	12,0	8,6	6,3	4,5	3,7
23 -	<b>32</b>	20,2	10,2	6,7	4,7	3,4	2,8

<b>U3/42</b>		s	s	s	s	s	s
10 -	<b>14</b>	21,8	11,4	7,0	5,0	3,7	2,8
14 -	<b>20</b>	22,4	11,2	6,7	4,5	3,2	2,4
20 -	<b>28</b>	21,8	10,8	6,5	4,5	3,3	2,5
28 -	<b>42</b>	25,2	13,3	8,0	5,5	4,0	3,1

<b>U3/74</b>		s	s	s	s	s	s
20 -	<b>28</b>	21,8	10,8	6,5	4,5	3,3	2,5
28 -	<b>42</b>	25,2	13,3	8,0	5,5	4,0	3,1
40 -	<b>52</b>	18,3	9,2	5,6	3,9	2,8	2,2
52 -	<b>65</b>	17,8	8,7	5,2	3,4	2,5	1,9

<b>U85 ..</b>		s	s	s	s	s	s
60 -	<b>90</b>	19,5	13,5	11,0	10,0	9,5	8,5
80 -	<b>120</b>	18,0	11,0	10,0	9,0	8,5	8,0

<b>U840 ..</b>		s	s	s	s	s	s
260 -	<b>360</b>	23,3	14,1	10,0	7,6	6,1	5,4
340 -	<b>480</b>	23,0	13,8	9,6	7,6	6,1	5,4
440 -	<b>620</b>	20,5	12,4	9,0	7,0	5,5	5,0
560 -	<b>800</b>	21,0	12,5	9,0	7,0	5,6	5,2

<b>U12/16E(A) ..</b>		s	s	s	s	s	s
0,12 -	<b>0,18</b>	18,5	10,4	7,2	5,5	4,3	3,6
0,18 -	<b>0,27</b>	16,7	9,8	6,5	5,0	4,1	3,5
0,27 -	<b>0,4</b>	19,4	12,1	8,2	5,9	4,9	4,2
0,4 -	<b>0,6</b>	18,7	11,2	8,0	6,0	4,9	4,1
0,6 -	<b>0,9</b>	19,7	11,6	8,1	6,1	4,9	4,2
0,8 -	<b>1,2</b>	22,9	13,6	10,0	7,3	6,0	5,2
1,2 -	<b>1,8</b>	22,2	13,2	9,2	7,6	5,8	5,3
1,8 -	<b>2,7</b>	23,0	13,7	9,3	7,6	5,7	5,1
2,7 -	<b>4</b>	24,0	14,4	9,9	7,8	5,9	5,1
4 -	<b>6</b>	24,7	13,8	9,9	7,3	5,6	4,8
6 -	<b>9</b>	22,0	13,4	8	5,7	4,1	3,5
8 -	<b>11</b>	17,4	9,2	5,9	4,1	2,9	2,3
10 -	<b>14</b>	26,4	12,9	7,6	5,2	3,5	2,8
13 -	<b>18</b>	14,7	7,7	4,8	3,2	2,3	1,7
17 -	<b>23</b>	16,2	8,4	5,0	3,6	2,4	1,8
22 -	<b>30</b>	16,8	8,5	5,0	3,6	2,3	1,9

## Relays With Quick Tripping Characteristic

preferably for motors with short  $t_E$  time and for submersible pumps

**Setting Range** Tripping time depending on the multiple of the current setting from cold condition (tolerance  $\pm 20\%$  of the tripping time)

A	A	I <sub>A</sub> /I <sub>N</sub> 3	I <sub>A</sub> /I <sub>N</sub> 4	I <sub>A</sub> /I <sub>N</sub> 5	I <sub>A</sub> /I <sub>N</sub> 6	I <sub>A</sub> /I <sub>N</sub> 7,2	I <sub>A</sub> /I <sub>N</sub> 8
<b>U12/16EQ ..</b>							
		s	s	s	s	s	s
0,4 -	<b>0,6</b>	13,6	8,4	5,9	4,2	3,3	3,0
0,6 -	<b>0,9</b>	13,8	7,8	5,2	4,1	3,2	2,7
0,8 -	<b>1,2</b>	13,1	7,5	5,2	3,9	3,1	2,7
1,2 -	<b>1,8</b>	14,6	8,7	6,0	4,6	3,6	3,2
1,8 -	<b>2,7</b>	13,5	7,6	5,3	3,9	3,1	2,7
2,7 -	<b>4</b>	11,0	6,0	4,1	2,6	1,7	1,4
4 -	<b>6</b>	9,6	5,3	3,3	2,3	1,6	1,3
6 -	<b>9</b>	10,2	5,4	3,4	2,3	1,6	1,3
8 -	<b>11</b>	12,0	6,2	3,9	2,5	1,8	1,3
10 -	<b>14</b>	12,8	6,6	4,0	2,6	1,8	1,4

All tripping times of overload relays U12/16EQ are shorter than the minimum values of the  $t_E$  time for motors of protection degree EEx e acc. to EN 50019 and therefore are suitable for all motors of protection degree EEx e. For these overload relays the selection on basis of tripping curves is thereby not necessary.

When selecting a standard overload, refer to the tripping curve. Determine the values of the starting current ratio  $I_A/I_N$  and the time  $t_E$  which is marked on the label of the motor. The overload must trip within the  $t_E$  time, which means that the tripping curve from cold condition must be (20% due to tolerance) below the co-ordination point  $I_A/I_N$  and the time  $t_E$ .

$I_A$  = Starting current of motor       $I_N$  = Rated current of motor  
 $t_E$  =  $t_E$ -time of motor

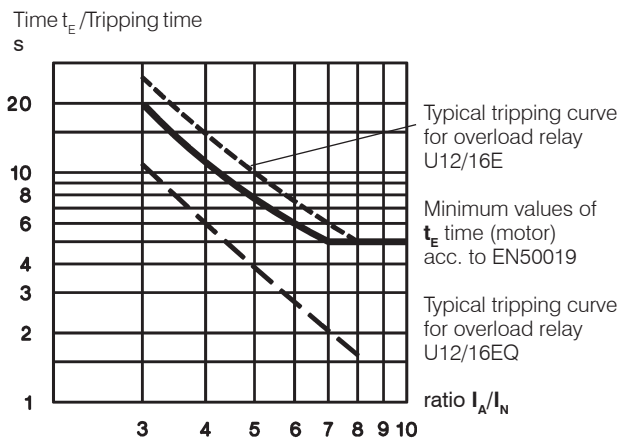

### Example of selection for thermal overload relay:

Technical data of a motor protection EEx e  
 $P_N = 1,5kW$      $I_N = 3,6A$      $I_A/I_N = 5$      $t_E$  time = 8s

1) U12/16E 4 (2,7 - 4A)  
 Tripping time at  $5 \times I_N = 9,9s$   
 $9,9s + 20\% \text{ tolerance} = 11,9s > t_{EMotor} = 8s$   
 The device U12/16E 4 is **not suitable**.

2) U12/16EQ 4 (2,7 - 4A)  
 Tripping time at  $5 \times I_N = 4,1s$   
 $4,1s + 20\% \text{ tolerance} = 4,9s < t_{EMotor} = 8s$   
 The device U12/16EQ 4 is **therefore suitable for motor protection**

# Thermal Overload Relays

## Fuses for U3/32, U3/42, U3/74, U12/16E, U85, U180, U320 and U800

Type	Setting Range		Max. Fuse Size According to Coordination-type				Fuse UL	SCCR		
	DOL	$\Delta$	"2" <sup>1)</sup>		"1" <sup>1)</sup>					
			A	A	quick A	slow, gL(gG) A	slow, gL(gG) A	aM A	A	kA
<b>U3/32</b> <b>(U12/16E)</b>	0,12 - <b>0,18</b>	-			0,5 <sup>2)</sup>	0,5 <sup>2)</sup>	25	-	15	5
	0,18 - <b>0,27</b>	-			1,0 <sup>2)</sup>	1,0 <sup>2)</sup>	25	-	15	5
	0,27 - <b>0,4</b>	-			2	2	25	-	15	5
	0,4 - <b>0,6</b>	-			2	2	25	-	15	5
	0,6 - <b>0,9</b>	-			4	4	25	-	15	5
	0,8 - <b>1,2</b>	-			4	4	25	2	15	5
	1,2 - <b>1,8</b>	-			6	6	25	2	15	5
	1,8 - <b>2,7</b>	-			10	10	25	4	15	5
	2,7 - <b>4</b>	-			16	10	25	4	15	5
	4 - <b>6</b>	7 - 10,5			20	16	25	6	15	5
	6 - <b>9</b>	10,5 - 15,5			35	25	35	10	25	5
	8 - <b>11</b>	14 - 19			35	25	35	16	30	5
	10 - <b>14</b>	18 - 24			50	35	63	16	40	5
13 - <b>18</b>	23 - 31			50	35	63	20	50	5	
17 - <b>(23)24</b>	30 - (40)41			63	50	63	25	60	5	
(22)23	- <b>(30)32</b>	(38)40	- (52)55	80	63	80	35	70	5	
<b>U3/42</b>	10 - <b>14</b>	18 - 24			50	35	80	16	40	5
	14 - <b>20</b>	24 - 35			63	50	80	25	60	5
	20 - <b>28</b>	35 - 48			80	63	80	35	80	5
	28 - <b>42</b>	48 - 73			100	80	150	50	110	5
<b>U3/74</b>	20 - <b>28</b>	35 - 48			100	80	150	35	80	5
	28 - <b>42</b>	48 - 73			125	100	150	50	110	5
	40 - <b>52</b>	70 - 90			160	100	150	63	200	5
	52 - <b>65</b>	90 - 112			160	125	150	80	250	10
	60 - <b>74</b>	104 - 128			160	125	150	80	250	10
<b>U85</b>	60 - <b>90</b>	104 - 156							300	10
	80 - <b>120</b>	140 - 207							-	10
<b>U180, U320</b> <b>U800</b>	all ranges								-	-
	all ranges								-	-

For short circuit protecting overload relays with current transformer use fuse according to the contactor of the combination.

### Tripping Characteristics for U3/32, U3/42, U3/74 and U12/16E

Detailed tripping times for each range see table page 124

#### with three-phase load

Tripping time min. s (Average value of typical tolerance curves from cold condition)

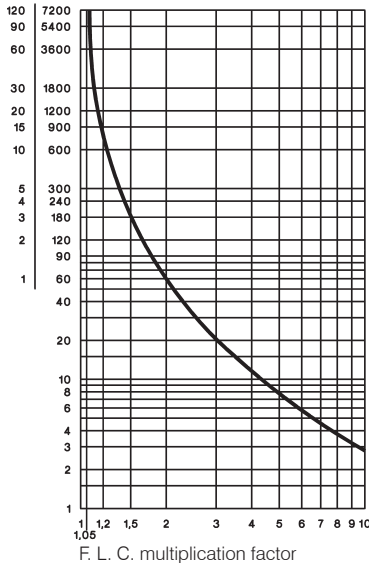

#### with two-pole load

Tripping time min. s (Typical tolerance curve from cold condition)

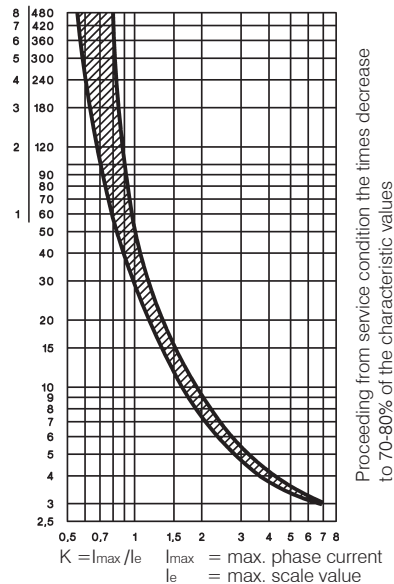

1) Coordination-type according to IEC 947-4-1:  
"2": Light contact welding accepted. Thermal overload relay must not be damaged.  
"1": Welding of contactor and damage of the thermal overload relay allowed.  
2) Miniature fuse

3) Suitable for use on a capability of delivering not more than

# Thermal Overload Relays

## Tripping Characteristics for U85, U180, U320, and U800

Detailed tripping times for each range of U85 see table page 124

### U85 with three-phase load

Tripping time (Average value of typical tolerance curves from cold condition)

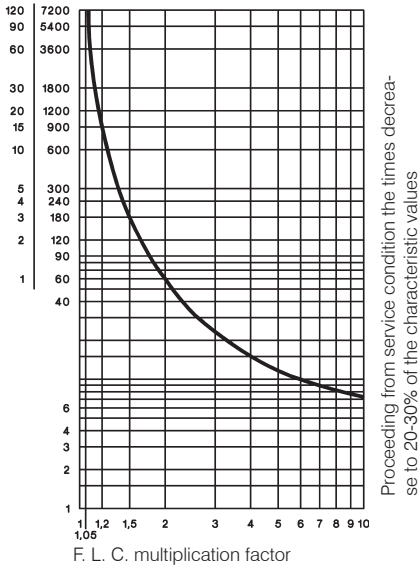

### U180, U320 with three-phase load

Tripping time (Average value of typical tolerance curves from cold condition)

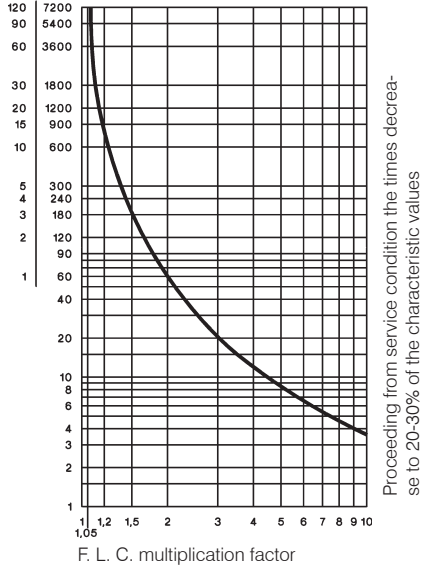

### U800 with three-phase load

Tripping time (Average value of typical tolerance curves from cold condition)

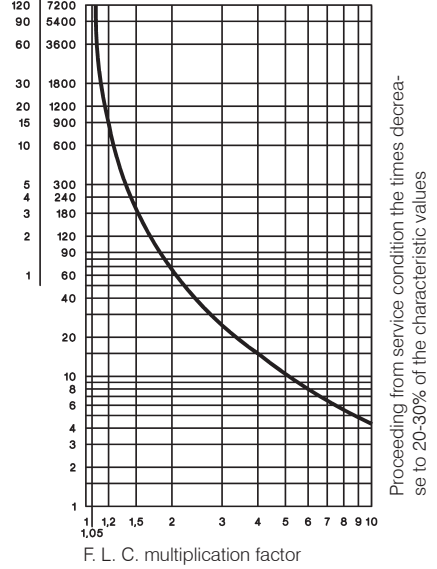

### U85 with two-pole load

Tripping time (Typical tolerance curve from cold condition)

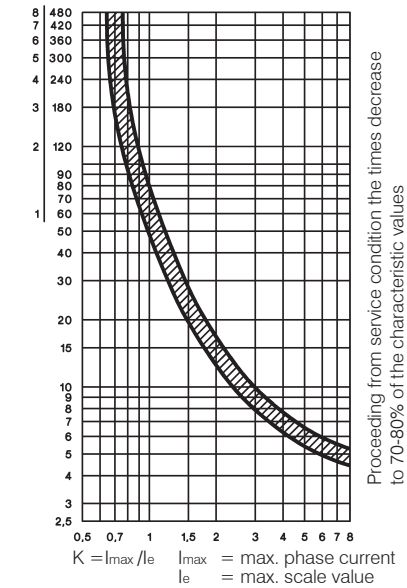

## Position of Terminals

### U3/32

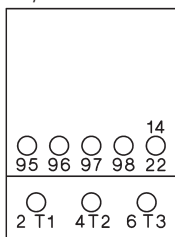

### U12/16E, U12/16EM, U12/16EQ

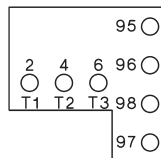

### U12/16A

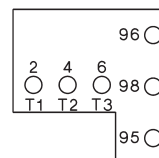

### U3/42, U3/74

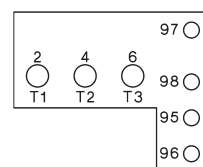

# Thermal Overload Relays in Special Version

## Fuse for U12/16EQ

Setting Range	Maximum Fuse Acc. to Coordination-type "2" 1)		
	quick "2" 1)	slow, gL(gG) "1" 1)	slow, gL(gG) "1" 1)
A	A	A	A
0,4 - <b>0,6</b>	2	2	25
0,6 - <b>0,9</b>	4	4	25
0,8 - <b>1,2</b>	4	4	25
1,2 - <b>1,8</b>	6	6	25
1,8 - <b>2,7</b>	10	10	25
2,7 - <b>4</b>	16	10	25
4 - <b>6</b>	20	16	25
6 - <b>9</b>	35	25	35
8 - <b>11</b>	35	25	35
10 - <b>14</b>	50	35	63

## Fuse for U12/16EM

Setting Range	Maximum Fuse Acc. to Coordination-type "2" 1)		
	380-400V slow, gL(gG) A	500V slow, gL(gG) A	660-690V slow, gL(gG) A
A	A	A	A
0,12 - <b>0,18</b>	none	none	on request
0,18 - <b>0,27</b>	none	none	on request
0,27 - <b>0,4</b>	none	none	on request
0,4 - <b>0,6</b>	none	none	on request
0,6 - <b>0,9</b>	none	none	on request
0,8 - <b>1,2</b>	none	10	on request
1,2 - <b>1,8</b>	none	16	on request
1,8 - <b>2,7</b>	20	20	on request
2,7 - <b>4</b>	35	35	on request

## Tripping Characteristic for U12/16EQ

Detailed tripping times for each range see table page 124

### with three-phase load

range 0,4-0,6 to 1,8-2,7A

Tripping time (Typical tolerance curve from cold condition)

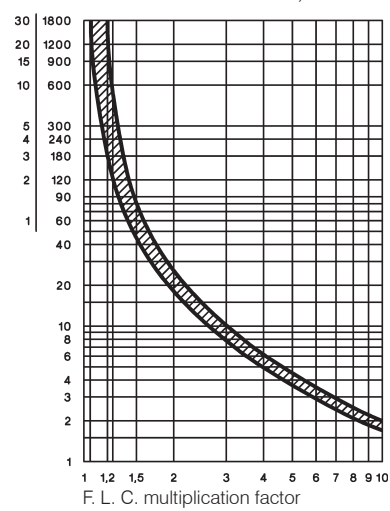

range 2,7-4 to 10-14A

Tripping time (Typical tolerance curve from cold condition)

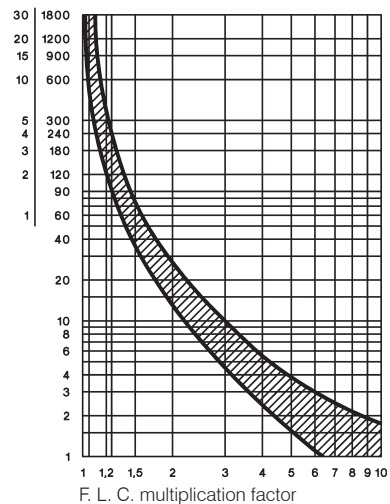

## Tripping Characteristic for U12/16EM

### with three-phase load

Tripping time (Average value of typical tolerance curves from cold condition)

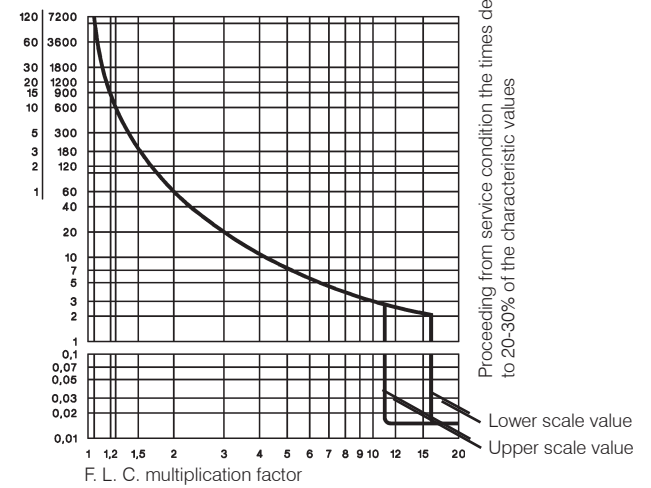

1) Coordination-type according to IEC 947-4-1:  
 "2": Light contact welding accepted. Thermal overload relay must not be damaged.  
 "1": Welding of contactor and damage of the thermal overload relay allowed.

# Thermal Overload Relays

Data according to IEC 947-4-1, IEC 947-5-1, VDE 0660, EN 60947-4-1, EN 60947-5-1

Type	U3/32	U12/16 <sup>6)</sup>	U3/42	U3/74	U85	U180	U320	U800
<b>Rated insulation voltage U<sub>i</sub><sup>1)</sup></b>	V~	690	690	690	690	750	1000	1000
<b>Permissible ambient temperature</b>								
operation	open	°C	-25 to +60					-25 to +55
storage		°C	-50 to +70					-40 to +70
<b>Trip class according to IEC 947-4-1</b>		10A	10A	10A	10A	20	10A	10A
<b>Cable cross-section</b>								
main connector	solid or stranded	mm <sup>2</sup>	0,75-6	0,75-6+0,75-2,5 <sup>2)</sup>	0,75-10	4-35 <sup>2)</sup>	<sup>3)</sup>	7)
	flexible	mm <sup>2</sup>	1-4	0,75-4+0,5-2,5 <sup>2)</sup>	0,75-6	6-25 <sup>2)</sup>		
	flexible with multicore cable end	mm <sup>2</sup>	0,75-4	0,5-2,5+0,5-1,5	0,75-6	4-25		
Cables per clamp	number		2	1+1	2	1		
auxiliary connector	solid	mm <sup>2</sup>		0,75-2,5 <sup>2)</sup>				1-2,5 <sup>2)</sup>
	flexible	mm <sup>2</sup>		0,5-2,5 <sup>2)</sup>				1-2,5 <sup>2)</sup>
	flexible with multicore cable end	mm <sup>2</sup>		0,5-1,5				1-2,5 <sup>2)</sup>
Cables per clamp	number			2				2

Type	U3/32	U12/16A	U12/16E	U12/16EQ	U3/42	U85	U180	U800
			U12/16EM		U3/74		U320	
<b>Auxiliary contacts</b>								
<b>Rated insulation voltage U<sub>i</sub><sup>1)</sup></b>								
same potential	V~	690	690	690	690	690	690	500
different potential	V~	440	-	440	440	250	440	500
<b>Utilization category AC15</b>								
Rated operational current I <sub>e</sub>	24V A	3	4	5	5	4	5	3
	230V A	2	2,5	3	3	2,5	3	2
	400V A	1	1,5	2	2	1,5	2	1
	690V A	0,5	0,6	0,6	0,6	0,6	0,5	0,6
<b>Utilization category DC13</b>								
Rated operational current I <sub>e</sub>	24V A	1	1,2	1,2	1,2	1,2	1,2	1
	110V A	0,15	0,15	0,15	0,15	0,15	0,15	0,15
	220V A	0,1	0,1	0,1	0,1	0,1	0,1	0,1
<b>Short circuit prot.</b> (without welding 1kA)								
highest fuse rating	gL (gG) A	4	4	6	6	6	4	6

Type	U3/32	U12/16	U12/16E	U3/42	U3/42	U3/74	U3/74	U85
Setting range	all	to 23A	22 - 30A	to 28A	28 - 42A	to 52A	52 - 65A	all
<b>Power loss per current path (max.)</b>								
minimum setting value	W	1,1	1,1	1,7	1,3	1,3	2,0	2,9
maximum setting value	W	2,3	2,3	3,7	2,6	3,3	3,7	4,5

## Data according to cULus

Type	U3/32	U12/16A	U12/16E	U3/42	U3/74	U85
<b>Rated insulation voltage</b>	V~	600	600	600	600	600
<b>Rated current</b>	A	32	23	23	42	75
<b>Auxiliary contacts</b>						
Rated voltage						
same potential	V~	600	600	600	600	600
different potential	V~	150	-	150	150	150
<b>Switching capacity AC</b>	VA	500	500	500	600	600
of aux. contacts	A	2	3	4	4	4

## Temperature Compensation

In case of higher ambient temperature use the following formula:  
**(Ambient temperature - 20) x 0,125 = correction factor in % of the full load motor current**

**Example: Ambient temperature 70°C, full load motor current 7A**  
**(70 - 20) x 0,125 = 6,25%**  
**Setting value: 7A x 1,0625 = 7,44A**

1) Suitable for: earthed-neutral systems, overvoltage category I to III, pollution degree 3 (standard-industry): U<sub>imp</sub> = 4kV (at 440V), 6kV (at 690V).

Data for other conditions on request.

2) Maximum cable cross-section with prepared conductor

3) Without terminals, suitable for bushing one connector 70mm<sup>2</sup> (stranded) per phase

4) Switching capacity of the start contact: AC15 300VA, max. 1,5A, DC13 (max. 220V) 30W, max. 1,5A

5) Switching capacity of the make contact: AC15 400VA, max. 1,7A, DC13 (max. 220V) 10W, max. 1A

6) U12/16E 30: Cable cross-section for main connector like type U3/42, one connector only

7) Busbar sets see accessories page 123

# Thermal Overload Relays

## Dimensions

K3-10N + U3/32

K3-14N

K3-18N

K3-22N

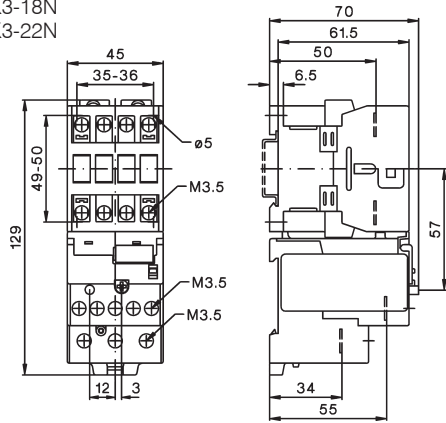

KG3-10 + U3/32

KG3-14

KG3-18

KG3-22

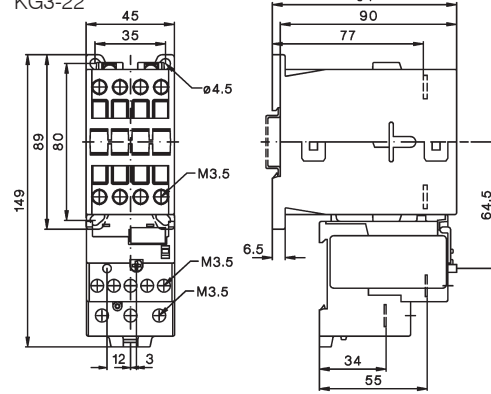

K3-24 + U3/32

K3-32

K3-40

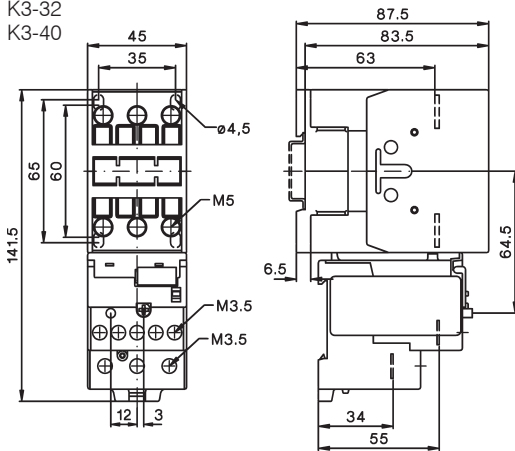

KG3-24 + U3/32

KG3-32

KG3-40

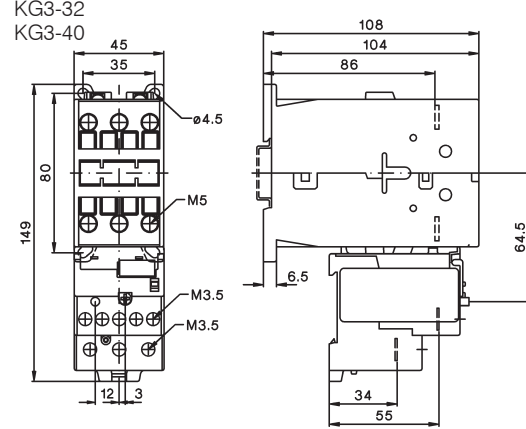

K3-24 + U3/42

K3-32

K3-40

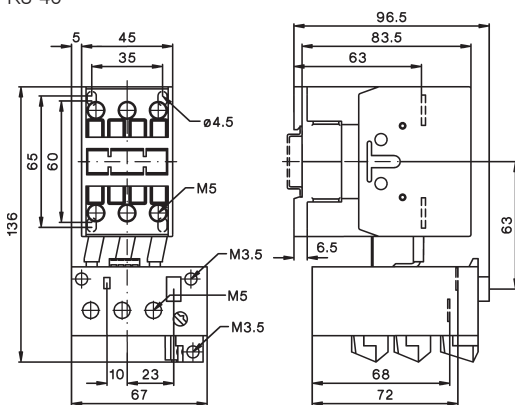

KG3-24 + U3/42

KG3-32

KG3-40

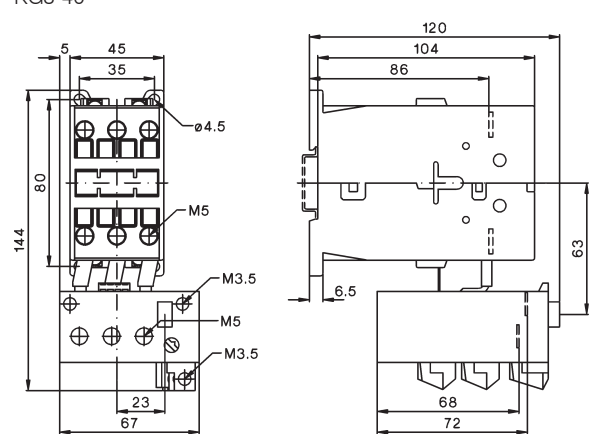

U3/32SM

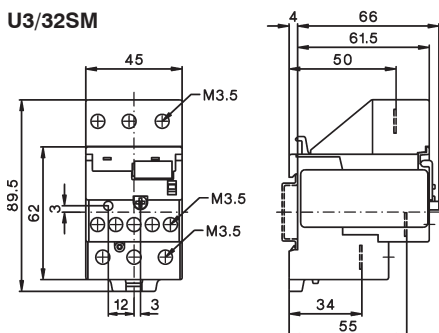

U3/42G + LG5830-

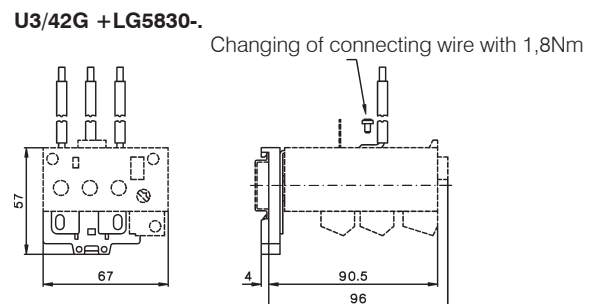

# Thermal Overload Relays

## Dimensions

K1-09 + U12/16..K1  
K1-12

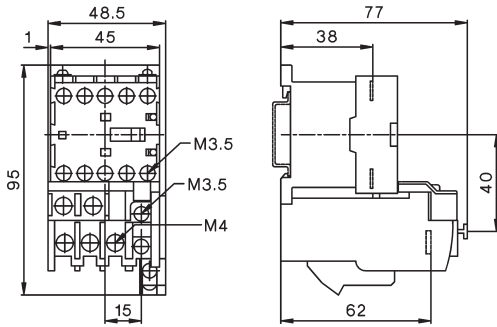

K3-10 + U12/16..K3  
K3-14  
K3-18  
K3-22

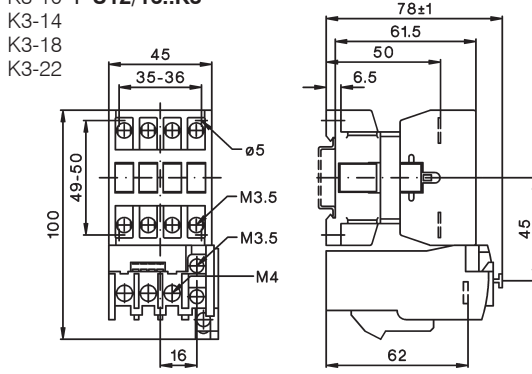

K3-10N + U12/16..K3  
K3-14N  
K3-18N  
K3-22N

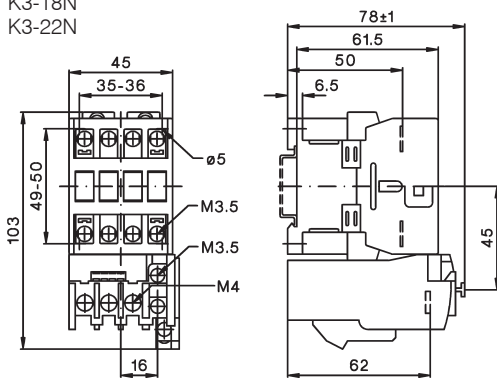

KG3-10 + U12/16..K3  
KG3-14  
KG3-18  
KG3-22

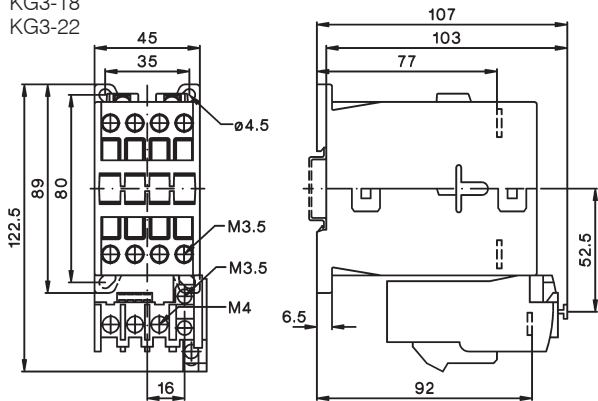

## U12SM K3

U12/16..K3 + U12SM K3 for snap-on 35mm DIN-rail according to DIN EN50022 and screw mounting (single mounting)

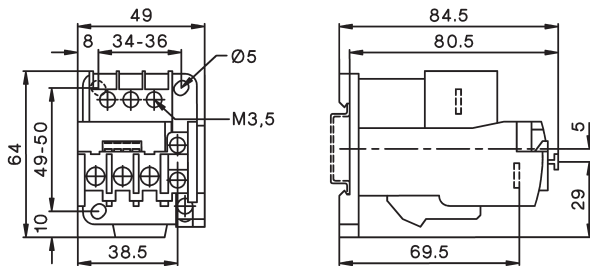

K3-50 + U3/74  
K3-62  
K3-74

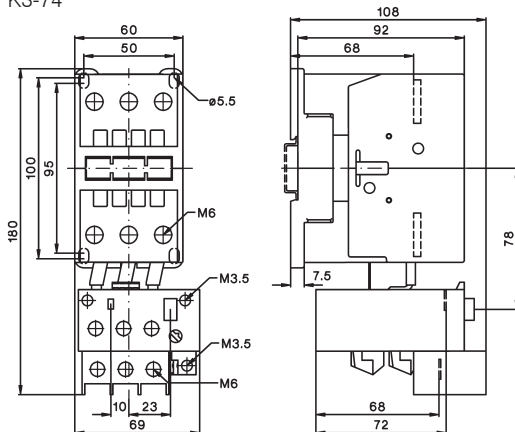

# Thermal Overload Relays

## Dimensions

K3-90A + U85  
K3-115A

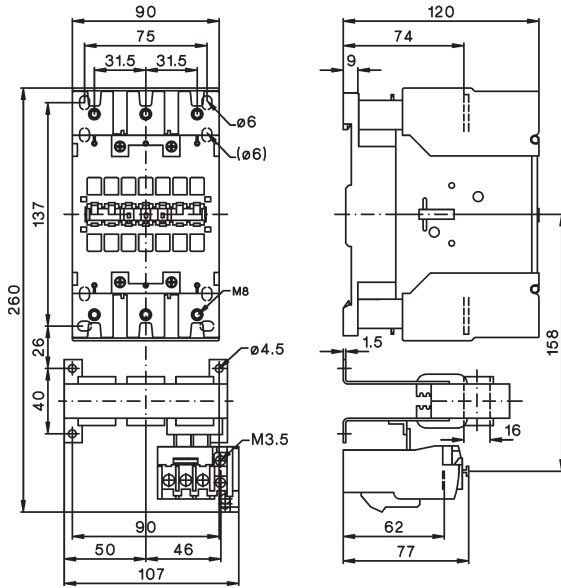

K3-151A00 + U180  
K3-176A00

Mounting holes

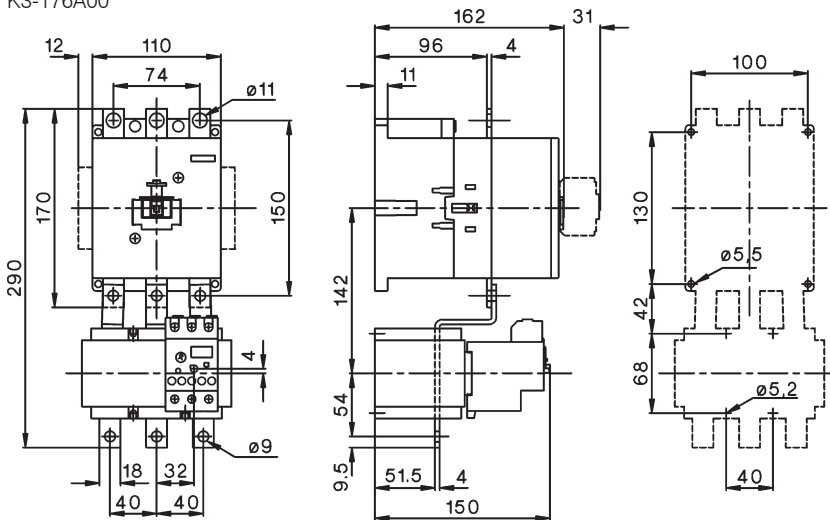

K3-210A00 + U320  
K3-260A00  
K3-316A00

Mounting holes

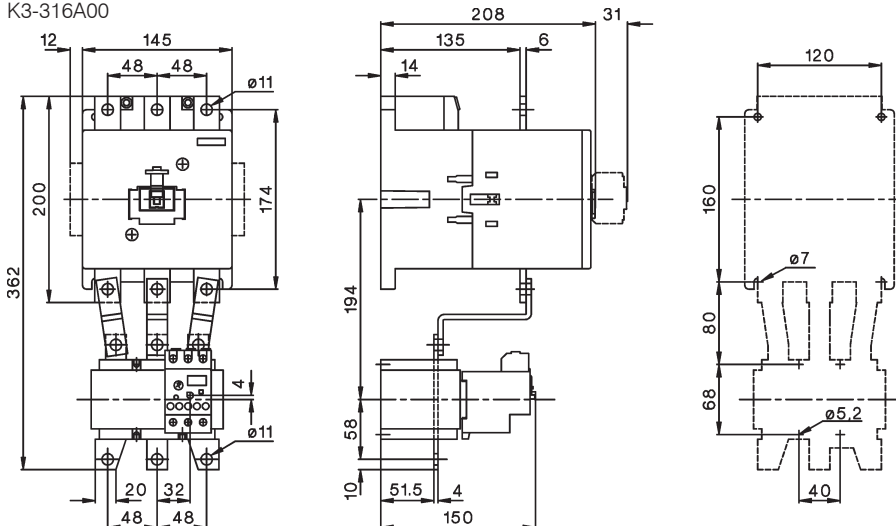



# Thermal Overload Relays

## Dimensions

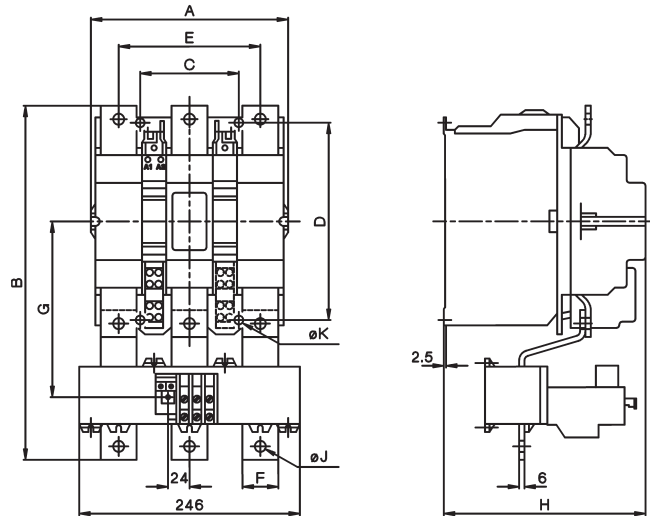
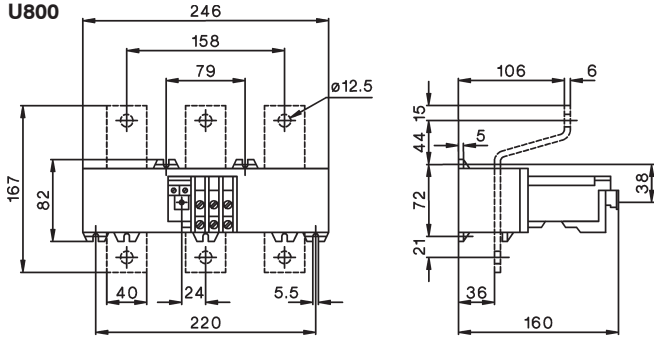
U800



U800 with	A	B	C	D	E	F	G	H	J	K
<b>K3-450</b>	220	372	110	220	158	40	185	225	12,5	9
<b>K3-550</b>	220	395	110	220	158	40	196	225	12,5	9
<b>K3-700</b>	280	487	175	280	202	50	257	291	14,5	11
<b>K3-860</b>	280	540	175	280	202	50	280	291	14,5	11

	<p>Modular Contactors</p>	<p>134</p>
	<p>Auxiliary Contact Block Accessories</p>	<p>136 136</p>
	<p>Switching Of Lamps</p>	<p>137</p>
	<p>Technical Data</p>	<p>139</p>
	<p>Dimensions</p>	<p>140</p>

# Modular Contactors, low noise

Rated Current	Heating Power AC1 at		Type	coil voltage		Pack pcs.	Weight kg/pc.	Wiring Diagram
	1-phase	3-phase		24	230			
<b>AC1 400V A</b>	230V kW	400V kW			24V 50/60Hz 220-240V 50Hz, 230-264V 60Hz			

## One-pole 1 module (17,5mm), AC-operated (low noise)



<b>20</b>	4,6	-	<b>R20-10 24</b>	12	0,12
<b>20</b>	4,6	-	<b>R20-10 230</b>	12	0,12



## Two-pole 1 module (17,5mm), AC-operated (low noise)



<b>20</b>	4,6	-	<b>R20-20 24</b>	12	0,12
<b>20</b>	4,6	-	<b>R20-20 230</b>	12	0,12

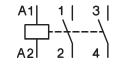

<b>20</b>	4,6	-	<b>R20-11 24</b>	12	0,12
<b>20</b>	4,6	-	<b>R20-11 230</b>	12	0,12

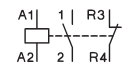

<b>20</b>	4,6	-	<b>R20-02 24</b>	12	0,12
<b>20</b>	4,6	-	<b>R20-02 230</b>	12	0,12

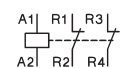

<b>25</b>	5,5	-	<b>R25-20 24</b>	12	0,14
<b>25</b>	5,5	-	<b>R25-20 230</b>	12	0,14

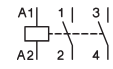

<b>25</b>	5,5	-	<b>R25-11 24</b>	12	0,14
<b>25</b>	5,5	-	<b>R25-11 230</b>	12	0,14

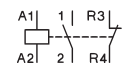

<b>25</b>	5,5	-	<b>R25-02 24</b>	12	0,14
<b>25</b>	5,5	-	<b>R25-02 230</b>	12	0,14

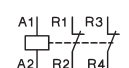

## Four-pole 2 modules (35mm) <sup>1)</sup>, AC-operated (low noise)



<b>25</b>	5,7	17	<b>R25-40 24</b>	6	0,21
<b>25</b>	5,7	17	<b>R25-40 230</b>	6	0,21

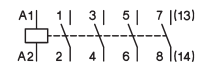

<b>25</b>	5,7	17	<b>R25-31 24</b>	6	0,21
<b>25</b>	5,7	17	<b>R25-31 230</b>	6	0,21

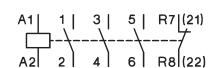

<b>25</b>	5,7	17	<b>R25-13 24</b>	6	0,21
<b>25</b>	5,7	17	<b>R25-13 230</b>	6	0,21

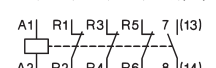

<b>25</b>	5,7	-	<b>R25-22 24</b>	6	0,21
<b>25</b>	5,7	-	<b>R25-22 230</b>	6	0,21

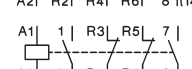

<b>25</b>	5,7	17	<b>R25-04 24</b>	6	0,21
<b>25</b>	5,7	17	<b>R25-04 230</b>	6	0,21

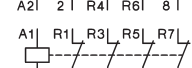

1) Sealable with Sealing Cover P721, available aux. contact block RH11(see page 136)

# Modular Contactors, hum free

Rated Current	Heating Power AC1 at		Type	coil voltage		Pack pcs.	Weight kg/pc.	Wiring Diagram
	1-phase	3-phase		24VM	230VM			
<b>400V</b>	230V	400V		24V 50/60Hz, 24V DC	220-240V 50/60Hz, 220V DC			
<b>A</b>	kW	kW		↓				

## One-pole 1 module (17,5mm), AC/DC-operated (hum free)



<b>20</b>	4,6	-	<b>R20-10 24VM</b>	12	0,12	
<b>20</b>	4,6	-	<b>R20-10 230VM</b>	12	0,12	

## Two-pole 1 module (17,5mm), AC/DC-operated (hum free)



<b>20</b>	4,6	-	<b>R20-20 24VM</b>	12	0,12	
<b>20</b>	4,6	-	<b>R20-20 230VM</b>	12	0,12	

<b>20</b>	4,6	-	<b>R20-11 24VM</b>	12	0,12	
<b>20</b>	4,6	-	<b>R20-11 230VM</b>	12	0,12	

<b>20</b>	4,6	-	<b>R20-02 24VM</b>	12	0,12	
<b>20</b>	4,6	-	<b>R20-02 230VM</b>	12	0,12	

<b>25</b>	5,5	-	<b>R25-20 24VM</b>	12	0,14	
<b>25</b>	5,5	-	<b>R25-20 230VM</b>	12	0,14	

<b>25</b>	5,5	-	<b>R25-11 24VM</b>	12	0,14	
<b>25</b>	5,5	-	<b>R25-11 230VM</b>	12	0,14	

<b>25</b>	5,5	-	<b>R25-02 24VM</b>	12	0,14	
<b>25</b>	5,5	-	<b>R25-02 230VM</b>	12	0,14	

## Four-pole 2 modules (35mm)<sup>1)</sup>, AC/DC-operated (hum free)



<b>25</b>	5,7	17	<b>R25-40 24VM</b>	6	0,21	
<b>25</b>	5,7	17	<b>R25-40 230VM</b>	6	0,21	

<b>25</b>	5,7	17	<b>R25-31 24VM</b>	6	0,21	
<b>25</b>	5,7	17	<b>R25-31 230VM</b>	6	0,21	

<b>25</b>	5,7	17	<b>R25-13 24VM</b>	6	0,21	
<b>25</b>	5,7	17	<b>R25-13 230VM</b>	6	0,21	

<b>25</b>	5,7	-	<b>R25-22 24VM</b>	6	0,21	
<b>25</b>	5,7	-	<b>R25-22 230VM</b>	6	0,21	

<b>25</b>	5,7	17	<b>R25-04 24VM</b>	6	0,21	
<b>25</b>	5,7	17	<b>R25-04 230VM</b>	6	0,21	

1) Sealable with Sealing Cover P721, available aux. contact block RH11(see page 136)

## Modular Contactors, low noise

Rated Current	Heating Power AC1 at	Type	coil voltage	Pack pcs.	Weight kg/pc.	Wiring Diagram
AC1	1-phase 3-phase	24	24V 50/60Hz			
400V	230V 400V	230	220-240V 50Hz, 230-264V 60Hz			
A	kW kW	↓				

### Two-pole 2 modules (35mm), AC-operated (low noise)



40	9	-	R40-20 24	6	0,23	
40	9	-	R40-20 230	6	0,23	
40	9	-	R40-02 24	6	0,23	
40	9	-	R40-02 230	6	0,23	
63	14,3	-	R63-20 24	6	0,23	
63	14,3	-	R63-20 230	6	0,23	
63	14,3	-	R63-02 24	6	0,23	
63	14,3	-	R63-02 230	6	0,23	

### Four-pole 3 modules (52,5mm)<sup>1)</sup>, AC-operated (low noise)



40	9	27,5	R40-40 24	4	0,35	
40	9	27,5	R40-40 230	4	0,35	
40	9	27,5	R40-31 24	4	0,35	
40	9	27,5	R40-31 230	4	0,35	
40	9	-	R40-22 24	4	0,35	
40	9	-	R40-22 230	4	0,35	
40	9	27,5	R40-04 24	4	0,35	
40	9	27,5	R40-04 230	4	0,35	
63	14,3	43	R63-40 24	4	0,36	
63	14,3	43	R63-40 230	4	0,36	
63	14,3	43	R63-31 24	4	0,36	
63	14,3	43	R63-31 230	4	0,36	
63	14,3	-	R63-22 24	4	0,36	
63	14,3	-	R63-22 230	4	0,36	
63	14,3	43	R63-04 24	4	0,36	
63	14,3	43	R63-04 230	4	0,36	

### Auxiliary Contact Block 1/2 module (8,8mm)<sup>2)</sup> for contactor R25, R40, R63 (4p.) max. 1 piece for contactor R40 and R63 (2p.) max. 1 piece



Rated current	AC15	AC1	Type	Pack pcs.	Weight kg/pc.	Wiring Diagram
AC15	400V	400V	for contactor			
230V	A	A				
3	2	10	R25 <sup>3)</sup> , R40, R63	3	0,026	
3	2	10	R25-..VM (4p.)	3	0,026	

### Accessories



Type	Pack pcs.	Weight kg/pc.
RC-unit 2x for R20.. to R63.. for 12V to 250V AC 220nF / 100 Ohm not for R20-.., R25-..VM	2	0,05
Spacing piece 1/2 module (8,8mm) for R20.. to R63.. for ambient temperature >40°C	10	0,012
Sealing cover for R25.. (4p.)	10	0,002
Sealing cover for R40-.., R63-..	10	0,003

1) Sealable with Sealing Cover P690, available aux. contact block RH11

2) Contacts suitable for electronic circuits, according to IEC60947-5-4 for rated voltage 24V DC (test ratings 17V DC, 5mA). Mirror contacts acc. IEC60947-4-1 Annex F.

3) AC-operated R25-... 4-pole

# Modular Contactors

## Switching of lamps

Lamp Type	Power W	Current A	Capacitors µF	Max. lamps per pole at 230V 50Hz and max. 60°C			
				R20..	R25..	R40..	R63..
<b>Incandescent lamps</b> (AC5b)	60	0,27	-	36	50	92	129
	100	0,45	-	21	30	55	77
	200	0,91	-	10	15	27	38
	300	1,36	-	7	10	19	26
	500	2,27	-	4	6	11	16
	1000	4,5	-	2	3	6	8
<b>Fluorescent lamps</b> uncompensated or serial compensated (AC5a)	11	0,16	1,3	60	75	210	310
	18	0,37	2,7	25	30	90	140
	24	0,35	2,5	25	30	90	140
	36	0,43	3,4	20	25	70	140
	58	0,67	5,3	14	17	45	70
	65	0,67	5,3	13	16	40	65
<b>Fluorescent lamps</b> dual-connection (AC5a)	11	0,07	-	2 x 100	2 x 110	2 x 220	2 x 250
	18	0,11	-	2 x 50	2 x 55	2 x 130	2 x 200
	24	0,14	-	2 x 40	2 x 44	2 x 110	2 x 160
	36	0,22	-	2 x 30	2 x 33	2 x 70	2 x 100
	58	0,35	-	2 x 20	2 x 22	2 x 45	2 x 70
	65	0,35	-	2 x 15	2 x 16	2 x 40	2 x 60
<b>Fluorescent lamps</b> parallel compensated (AC5a)	11	0,09	2	33	43	67	107
	18	0,13	2	25	32	50	80
	24	0,16	3	25	32	50	80
	36	0,27	4	22	32	50	80
	58	0,45	7	14	18	36	46
	65	0,5	7	14	18	36	46
<b>Fluorescent lamps</b> with electronic fluorescent lamp ballast (AC5a)	18	0,09	-	40	40	100	150
	36	0,16	-	20	20	52	75
	58	0,25	-	15	15	30	55
	80	0,4	-	7	10	20	30
	2 x 18	0,17	-	20	20	50	60
	2 x 28	0,25	-	15	15	37	45
2 x 36	0,32	-	10	10	25	30	
2 x 58	0,49	-	7	7	15	20	
2 x 80	0,7	-	4	4	8	10	
<b>Transformers for metal halid low voltage lamps</b> (AC5a)	20	0,09	-	40	52	110	174
	50	0,22	-	20	24	50	80
	75	0,33	-	13	16	35	54
	100	0,43	-	10	12	27	43
	150	0,65	-	7	9	19	29
	200	0,87	-	5	5	14	23
300	1,3	-	3	4	9	14	
<b>Mercury-vapour lamps</b> (high-pressure lamps), uncompensated e. g. HQL, HPL (AC5a)	50	0,61	-	16	21	38	55
	80	0,8	-	12	16	29	40
	125	1,15	-	8	11	20	28
	250	2,15	-	4	6	11	15
	400	3,25	-	3	4	7	10
	700	5,4	-	1	2	4	6
1000	7,5	-	1	1	3	4	
<b>Mercury-vapour lamps</b> (high-pressure lamps), compensated e. g. HQL, HPL (AC5a)	50	0,28	7	14	18	36	50
	80	0,41	8	12	16	31	44
	125	0,65	10	10	13	25	35
	250	1,22	18	5	7	14	19
	400	1,95	25	4	5	10	14
	700	3,45	45	2	3	6	8
1000	4,8	60	1	2	4	6	

# Modular Contactors

## Switching of lamps

Lamp Type	Power W	Current A	Capacitors $\mu\text{F}$	Max. lamps per pole at 230V 50Hz and max. 60°C				
				R20..	R25..	R40..	R63..	
<b>Metal halide lamps</b> uncompensated e. g. HQI, HPI, CDM (AC5a)	35	0,53	-	22	24	57	65	
	70	1	-	12	14	30	35	
	150	1,8	-	6	8	17	18	
	250	3	-	4	5	10	12	
	400	3,5	-	3	4	8	10	
	1000	9,5	-	1	1	3	4	
	2000	16,5	-	-	-	2	2	
	400V per pole	2000	10,5	-	-	2	2	
		3500	18	-	-	1	1	
	<b>Metal halide lamps</b> compensated e. g. HQI, HPI, CDM (AC5a)	35	0,25	6	16	21	42	58
70		0,45	12	8	11	21	29	
150		0,75	20	5	7	13	18	
250		1,5	33	3	4	9	11	
400		2,1	35	2	4	9	10	
1000		5,8	95	1	1	3	4	
2000		11,5	148	-	-	2	2	
400V per pole		2000	6,6	58	-	-	3	4
		3500	11,6	100	-	-	2	3
<b>Metal halide lamps</b> with electronic fluorescent with electronic fluorescent lamp ballast (e. g.: PCI) 50-125 x I <sub>n lamp</sub> for 0,6ms (AC5a)		20	0,1	integrated	9	9	18	20
	28	0,15	integrated	-	-	-	18	
	35	0,2	integrated	6	6	11	13	
	70	0,36	integrated	5	5	10	12	
	150	0,7	integrated	4	4	8	10	
<b>Sodium-vapour lamps</b> (low pressure lamps), uncompensated (AC5a)	35	1,5	-	7	9	22	30	
	55	1,5	-	7	9	22	30	
	90	2,4	-	4	6	13	19	
	135	3,3	-	3	4	10	14	
	150	3,3	-	3	4	10	14	
	180	3,3	-	3	4	10	14	
	200	3,3	-	3	4	10	14	
<b>Sodium-vapour lamps</b> (low pressure lamps), compensated (AC5a)	35	0,31	20	5	6	15	18	
	55	0,42	20	5	6	15	18	
	90	0,63	30	3	4	10	12	
	135	0,94	45	2	3	7	8	
	150	1	40	2	3	8	9	
	180	1,16	40	2	3	8	9	
200	1,32	25	-	-	10	12		
<b>Sodium-vapour lamps</b> (high pressure lamps), uncompensated (AC5a)	150	1,8	-	5	8	17	22	
	250	3	-	4	5	10	13	
	330	3,7	-	3	4	8	10	
	400	4,7	-	2	3	6	8	
1000	10,3	-	1	1	3	4		
<b>Sodium-vapour lamps</b> (high pressure lamps), compensated (AC5a)	150	0,83	20	5	7	20	25	
	250	1,5	33	3	4	12	15	
	330	2	40	2	3	10	13	
	400	2,4	48	2	2	8	12	
1000	6,3	106	1	1	4	6		
<b>Sodium-vapour lamps</b> (high pressure lamps) with serial electronic (e. g.: PCI) 50-125 x I <sub>n lamp</sub> for 0,6ms (AC5a)	20	0,1	integrated	9	9	18	20	
	35	0,2	integrated	6	6	11	13	
	70	0,36	integrated	5	5	10	12	
	150	0,7	integrated	4	4	8	10	

### LED-Lamps

consider the inrush current  
of the lamp ballast and  
the  $\cos\phi$  of the lamp

max. inrush current of contactor [A]

195A    233A    424A    565A

$$\frac{\text{inrush current of contactor}}{\text{inrush current of lamp/EVG}} =$$

max. lamps per pole at 230V 50Hz and max. 60°C ( $I_{n,LED} \leq I_{th}$ )

# Modular Contactors

Data according to IEC60 947-4-1, IEC 60947-5-1, VDE 0660-5-1

Type	2-pole				4-pole			RH11			
	R20 (VM) <sup>7)</sup>	R25 (VM) <sup>7)</sup>	R40	R63	R25 (VM) <sup>7)</sup>	R40	R63				
<b>Main Contacts</b> <sup>4) 5) 6)</sup>											
<b>Rated insulation voltage</b> $U_i$ <sup>1)</sup>	V~		<b>440</b>	<b>440</b>	<b>440</b>	<b>440</b>	<b>440</b>	<b>440</b>			
Rated operation voltage $U_e$	V~		440	440	440	440	440	440			
<b>Frequency of operations</b> z AC1, AC3	1/h		300	300	600	600	600	600			
<b>Mechanical life</b>	S x 10 <sup>6</sup>		1	1	1	1	1	1			
<b>Utilization category AC1 / AC7a</b>											
<b>Switching of resistive load</b>											
Rated operational current $I_e$ (=I <sub>th</sub> ) open at 60°C	A		20	25	40	63	25	40	63	-	
<b>Contact life</b>	S x 10 <sup>6</sup>		0,1	0,1	0,1	0,1	0,1	0,1	0,1	-	
<b>Minimum Switch Voltage</b>	V/mA		24/100	24/100	24/100	24/100	24/100	24/100	24/100	17/5	
<b>Short time current</b>	10s-current		A	72	72	216	240	72	216	240	-
<b>Power loss</b> per pole at I <sub>e</sub> /AC1	W		2	3	3	7	2	3	7	0,5	
<b>Utilization category AC2 and AC3 / AC7b</b>											
<b>Switching of three-phase motors</b>											
Rated operational current $I_e$	A		-	-	-	-	9	27	30	-	
Rated operational power of three-phase motors			-	-	-	-	2,2	7,5	8	-	
50-60Hz			-	-	-	-	2,5	8	8,5	-	
			-	-	-	-	4	12,5	15	-	
2-pole motors			-	-	-	-	-	-	-	-	
			1,1 <sup>2)</sup>	1,3	2,6	5	-	-	-	-	
<b>Contact life</b>	S x 10 <sup>6</sup>		0,15	0,15	0,15	0,15	0,15	0,15	0,15	-	
<b>Power consumption of coils</b>											
AC operated											
		inrush	VA	7 - 9	7 - 9	20 - 25	20 - 25	20 - 25	33 - 45	33 - 45	-
		sealed	VA	2,2 - 4,2	2,2 - 4,2	4 - 6	4 - 6	4 - 6	6 - 8	6 - 8	-
			W	0,8 - 1,6	0,8 - 1,6	1,5 - 2,5	1,5 - 2,5	1,5 - 2,5	2 - 3,3	2 - 3,3	-
AC and DC-operated			W	2 - 3	2 - 3	-	-	-	-	-	-
<b>Operation range of coils</b>											
in multiples of control voltage $U_s$ (-40° - +40°C)			0,85 - 1,1	0,85 - 1,1	0,85 - 1,1	0,85 - 1,1	0,85 - 1,1	0,85 - 1,1	0,85 - 1,1	-	
<b>Noise level (operation) acc. to EN ISO 3744</b>											
from front, distance 0,5 m		dB	16 (0) <sup>7)</sup>	16 (0) <sup>7)</sup>	8	8	8 (0) <sup>7)</sup>	< 4	< 4	-	
Type			R20	R25 (2p.)	R25 (4p.)	R25-..VM	R40 (2p./4p.)	R63 (2p./4p.)	RH11		
<b>Maximum ambient temperature</b>											
Operation		°C					-40 to + 60				
		°C					-40 to + 40				
Storage		°C					-50 to + 90				
<b>Short circuit protection</b>											
max. fuse Coordination-type "1" gL (gG)	A		35	35	35	35	63	80	-		
Rated short circuit current	"I <sub>m</sub> "	kA	3	3	3	3	3	3	-		
	"I <sub>q</sub> "	kA	3	3	10	10	10	10	-		
<b>Switching time</b> at control voltage $U_s \pm 10\%$											
		ms	7 - 16	7 - 16	9 - 15	17 - 50	11 - 15	11 - 15	-		
		ms	6 - 12	6 - 12	4 - 8	17 - 23	6 - 13	6 - 13	-		
		ms	10 - 15	10 - 15	10 - 15	10 - 15	10 - 15	10 - 15	-		
<b>Cable cross-sections</b>											
Main connector		mm <sup>2</sup>	1,5 - 10	1,5 - 10	1,5 - 10	1,5 - 10	2,5 - 25	2,5 - 25	0,5 - 2,5 <sup>3)</sup>		
		mm <sup>2</sup>	1,5 - 6	1,5 - 6	1,5 - 6	1,5 - 6	2,5 - 16	2,5 - 16	0,5 - 2,5 <sup>3)</sup>		
		mm <sup>2</sup>	1,5 - 6	1,5 - 6	1,5 - 6	1,5 - 6	2,5 - 16	2,5 - 16	0,5 - 1,5		
Clamps per pole			1	1	1	1	1	1	2		
Magnetic coil		mm <sup>2</sup>	0,75 - 2,5	0,75 - 2,5	0,75 - 2,5	0,75 - 2,5	0,75 - 2,5	0,75 - 2,5	-		
		mm <sup>2</sup>	0,5 - 2,5	0,5 - 2,5	0,5 - 2,5	0,5 - 2,5	0,5 - 2,5	0,5 - 2,5	-		
		mm <sup>2</sup>	0,5 - 1,5	0,5 - 2,5	0,5 - 1,5	0,5 - 1,5	0,5 - 1,5	0,5 - 1,5	-		
Clamps per pole			1	1	1	1	1	1	-		
<b>Auxiliary Contacts</b> <sup>4) 5) 6)</sup>											
<b>Rated insulation voltage</b> $U_i$ <sup>1)</sup>	V AC		-	-	440	440	440	440	440		
<b>Thermal rated current</b> $I_{th}$	40°C		-	-	25	25	40	63	10		
Ambient temperature	60°C		-	-	25	25	40	63	6		

1) Suitable for: earthed-neutral systems, overvoltage category I to III, pollution degree 3 (standard-industry):  $U_{imp} = 4kV$ .

2) AC7b motor 2-pole 230V 1,1kW

3) Maximum cable cross-section with prepared conductor

4) Rated frequency 50/60Hz

5) Max. occ. switching overvoltage < 4kV

6) Duty cycle: 100%

7) 0 dB for contactors type "VM" (AC/DC operated)

# Modular Contactors

Data according to IEC60 947-4-1, IEC 60947-5-1, VDE 0660-5-1

Type	R20	R25 (2p.)	R25 (4p.)	R25-..VM	R40 (2p./4p.)	R63 (2p./4p.)	RH11
<b>Utilization category AC15</b>							
Rated operational current $I_e$	220-240V A	-	3	3	3	3	3
	380-415V A	-	2	2	2	2	2
	440V A	-	1,6	1,6	1,6	1,6	1,6
<b>Utilization category DC13</b>							
Rated operational current $I_e$	24-60V A	-	2	2	2	2	2
per pole	110V A	-	0,4	0,4	0,4	0,4	0,4
	220V A	-	0,1	0,1	0,1	0,1	0,1
<b>Short circuit protection</b>							
short-circuit current 1kA, contact welding not accepted							
max. fuse size	gL (gG) A	-	10	10	10	10	10

## Data according to UL508

Main Contacts (cULus)	Type	R20	R25 (2p.)	R25 (4p.)	R40 (2p./4p.)	R63 (2p./4p.)	RH11
Rated operational current "General Use"	A	20	25	25	40	63	10
Rated operational power of three-phase motors at 60Hz (3ph)	110-120V hp	-	-	1	2	3	-
	200-208V hp	-	-	2	5	7½	-
	220-240V hp	-	-	3	7½	10	-
	265-277V hp	-	-	3	7½	10	-
Rated operational power of AC motors at 60Hz (1ph / 2-pole break)	110-120V hp	½	½	½	1	1½	-
	200-208V hp	1	1	1	2	3	-
	220-240V hp	1½	1 ½	1½	3	5	-
	265-277V hp	1½	2	2	3	5	-
Fuses	A	40	40	40	80	80	-
Suitable for use on a capability of delivering not more than	rms A	5000	5000	5000	5000	5000	-
	V	300	300	300	300	300	300
Rated operation voltage	V~	300	300	300	300	300	300
<b>Auxiliary Contacts (cULus)</b>	heavy pilot duty AC	-	-	-	-	-	C300

## Dimensions

R20-.., R25-.. (2-pole)  
RC-R 230

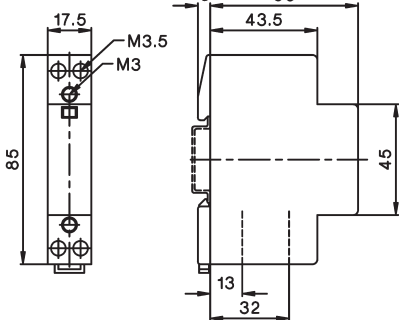

R25-.. (4-pole) (+RH11)  
R25-..VM (+RH11-1)

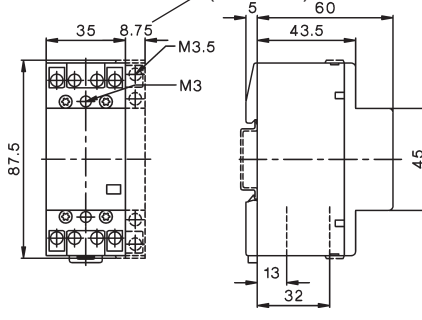

R40-.. (2-pole)  
R63-.. (2-pole)

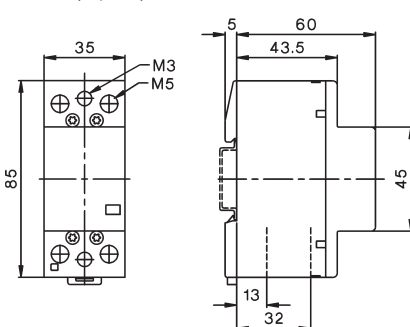

R40-.. (4-pole) (+RH11)  
R63-.. (4-pole) (+RH11)

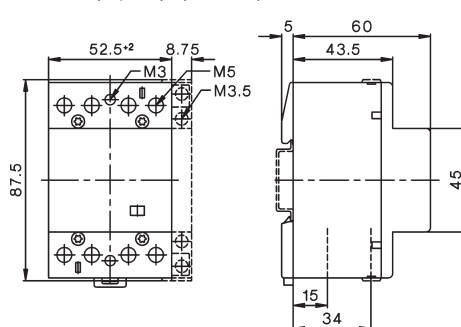

Aux. contact block  
RH11, RH11-1

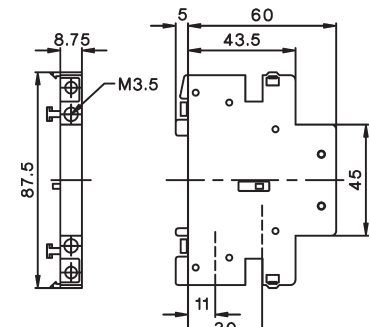

# Contactors for DC-Switching

AC-operated

## Rated Operational Current

DC1

Additional  
Aux.  
Contacts

Coil voltage <sup>1)</sup>  
**230**  
220-230V 50Hz, 240V 60Hz

Pack Weight  
pcs. kg/pcs.

Wiring diagram



600V	1000V	1200V		Type			
20A	-	-	2 HKA11	<b>K3DC-20A00 ...</b>	1	0,5	
50A	-	-	+1 HKT.	<b>K3DC-48A00 ...</b>	1	0,5	
60A	30A	-	2 HKA11	<b>K3DC-60A00 ...</b>	1	1,2	
80A	60A	-	+1 HKT.	<b>K3DC-80A00 ...</b>	1	1,2	
100A	-	-		<b>K3DC-100A00 ...</b>	1	1,8	
12A	12A	6A	2 HKA11 +2 HKT.	<b>K3PV-12A00 ...</b>	1	0,8	
30A	30A	-	2 HKA11	<b>K3PV-30A00 ...</b>	1	1,55	
60A	60A	-	+2 HKT.	<b>K3PV-60A00 ...</b>	1	1,55	
80A	80A	-	2 HKA11	<b>K3PV-80A00 ...</b>	1	1,5	
100A	100A	-	+1 HKT.	<b>K3PV-100A00 ...<sup>2)3)</sup></b>	1	2,3	
150A	150A	-	2 HKA11	<b>K3PV-150A00 ...<sup>2)3)</sup></b>	1	5	
200A	200A	-	+1 HKT.	<b>K3PV-200A00 ...<sup>2)3)</sup></b>	1	5	
240A	240A	-		<b>K3PV-240A00 ...<sup>2)3)</sup></b>	1	5	
300A	300A	-	2 HKA11	<b>K3PV-300A00 ...<sup>2)3)</sup></b>	1	7,5	
400A	400A	-	+1 HKT.	<b>K3PV-400A00 ...<sup>2)3)</sup></b>	1	7,5	
450A	450A	-		<b>K3PV-450A00 ...<sup>2)3)</sup></b>	1	7,5	

# Contactors for DC-Switching for PV-installations, as remote controlled fire protection defeat device

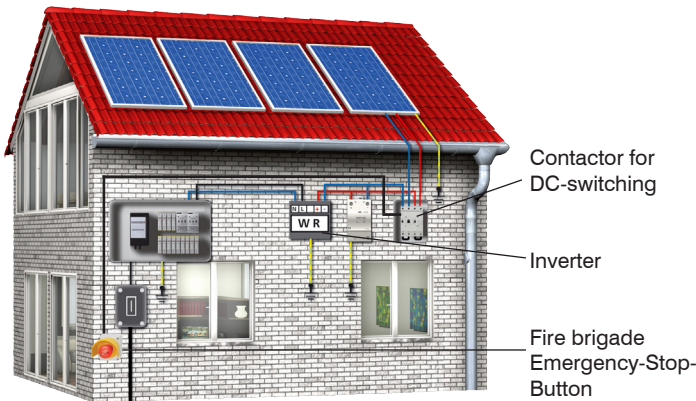

In most Photovoltaic-installations, the switch disconnectors according to IEC 60364-7-712 are integrated in the DC/AC-inverter. So the wires between solar-panels and inverter are continuously under voltage. According to ÖVE-R11-1: 2013, Photovoltaic-installations must have a fire protection defeat device. For this purpose, BENEDICT contactors for DC-switching, used as a fire protection defeat device, can switch off the Photovoltaic-installation with a remote controlled fire brigade Emergency-Stop-button.

Switch diagram (4 contacts)

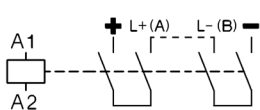

Connection diagram 1-pole:  
connect L+(A) and L-(B) (jumper attached)

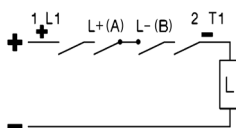



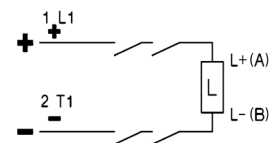









Connection diagram 2-pole:  
don't use attached jumper

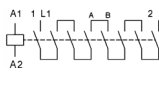

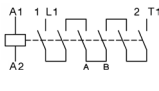

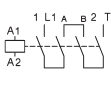
1) Other coil voltages from 24 to 600V AC, on request  
2) Type for AC- and DC-operating: e.g.: 230: 220-240V 50/60Hz and 220V=  
3) With integrated coil suppressor

# Contactors for DC-Switching

DC-operated

Type	Coil voltage <sup>1)</sup>	Aux. Contacts	Pack pcs.	Weight kg/pcs.	Wiring diagram
	24 24V= DC	additional			
	<b>KG3DC-12A00</b> ... <sup>5)</sup>	1 HKA11	1	0,5	
	<b>KG3DC-20A00</b> ... <sup>5)</sup>	+1 HKT.	1	0,5	
	<b>KG3DC-48A00</b> ... <sup>5)</sup>	+1 HKT.	1	0,5	
	<b>K3DC-60A00=</b> ... <sup>5)</sup>	1 HKA11	1	1,2	
	<b>K3DC-80A00=</b> ... <sup>5)</sup>	+1 HKT.	1	1,2	
	<b>K3DC-100A00=</b> ...		1	1,8	
	<b>KG3PV-12A00</b> ...	1 HKA11 +2 HKT.	1	0,85	
	<b>KG3PV-30A00</b> ... <sup>5)</sup>	1 HKA11 +2 HKT.	1	1,55	
	<b>KG3PV-60A00</b> ... <sup>5)</sup>	1 HKA11 +2 HKT.	1	1,55	
	<b>KG3PV-80A00=</b> ... <sup>5)</sup>	2 HKA11 +1 HKT.	1	1,5	
	<b>K3PV-100A00</b> ... <sup>2) 5)</sup>	2 HKA11 +1 HKT.	1	2,3	
	<b>K3PV-150A00</b> ... <sup>2) 5)</sup>	2 HKA11 +1 HKT.	1	5	
	<b>K3PV-200A00</b> ... <sup>2) 5)</sup>	2 HKA11 +1 HKT.	1	5	
	<b>K3PV-240A00</b> ... <sup>2) 5)</sup>		1	5	
	<b>K3PV-300A00</b> ... <sup>2) 5)</sup>	- -	2 HKA11	1	
	<b>K3PV-400A00</b> ... <sup>2) 5)</sup>	- -	1	7,5	
	<b>K3PV-450A00</b> ... <sup>2) 5)</sup>	- -	1	7,5	
	<b>K3PV-450A00</b> ... <sup>2) 5)</sup>	- -	1	7,5	

## Auxiliary Contact Blocks for contactors K(G)3DC-.. and K(G)3PV-.., for low level switching<sup>4)</sup>

Type	Rated Operational Current			for contactors	Type	Pack pcs.	Weight kg/pcs.	Wiring diagrams
	AC15	AC15	AC1					
	230V	400V	690V					
	A	A	A					
	<b>3</b>	2	10	K(G)3DC, K(G)3PV-.. top	<b>HKT11</b>	1	0,04	
	<b>3</b>	2	10	K(G)3DC, K(G)3PV-.. top	<b>HKT22</b>	1	0,05	
	<b>3</b>	2	10	K(G)3DC, K(G)3PV-.. top	<b>HKT31</b>	1	0,05	
<b>3</b>	2	10	K(G)3DC, K(G)3PV-.. top	<b>HKT40</b>	1	0,05		
<b>3</b>	2	10	K(G)3DC, K(G)3PV-.. side	<b>HKA11</b>	1	0,05		

## Accessories

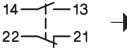

<b>Fire Brigade-EMERGENCY STOP key operated button</b> Ø40mm, according to EN418, unlock by key	<b>BG10P44S3-11 +SK</b>	1	0,22		3)
---	-------------------------	---	------	---	----

1) Other coil voltages from 24 to 250V DC, on request  
 2) Type for AC- and DC-operating: e.g.: 24: 24V 50/60Hz and 24V=  
 3) → opener positive opening acc. IEC/EN60947-5-1  
 4) Contacts suitable for electronic circuits, according to IEC60947-5-4 for rated voltage 24V DC (test ratings 17V DC, 5mA) Mirror contacts acc. IEC60947-4-1 Annex F. Technical data see page 78  
 5) With integrated coil suppressor

# Technical Data

Data according to IEC 60947-4-1, VDE 0660

Type	K(G)3DC- 12.. 20.. 48..			K3DC- 60.. 80..		K3DC- 100..	K(G)3PV- 12.. 30.. 60..			K3PV- 80..	K3PV- 100..	K3PV- 150.. 200.. 240..			K3PV- 300.. 400.. 450..					
Rated insulation Voltage V= U <sub>imp</sub> kV	600	600	600	1000	1000	600	1200	1000	1000	1000	1000	1000	1000	1000	1000	1000	1000			
Poles in series	3	3	3	3	3	3	8	6	6	4	4	3	3	3	3	3	3			
DC1 600V dc I <sub>b</sub> A	12	20	50	60	80	100	12	30	60	80	100	150	200	240	300	400	450			
DC1 1000V dc I <sub>b</sub> A	1	-	-	30	60	-	12	30	60	80	100	150	200	240	300	400	450			
DC1 1200V dc I <sub>b</sub> A	-	-	-	-	-	-	6	-	-	-	-	-	-	-	-	-	-			
DC3/5 310V dc I <sub>b</sub> A	-	-	-	-	40	60	-	15	24	40	90	125	170	200	230	270	300			
DC3/5 460V dc I <sub>b</sub> A	-	-	-	-	-	-	-	15	24	40	40	125	170	200	230	270	300			
DC3/5 600V dc I <sub>b</sub> A	-	-	-	-	-	-	-	-	-	-	-	50	60	75	120	160	200			
Main pole resistance mΩ	2	2	1,8	1,4	1,2	1	2,2	1,8	1,8	1,2	1	0,5	0,5	0,35	0,15	0,15	0,15			
Poles in series resistance mΩ	5,4	5,4	5,4	4,2	3,6	3	17,6	10,8	10,8	4,8	4	1,5	1,5	1,1	0,5	0,5	0,5			
electrical life	100 k	100 k	90 k	90 k	90 k	60 k	100 k	100 k	90 k	90 k	60 k	60 k	60 k	60 k	50 k	50 k	50 k			
mechanical life	10 Mio.																			
Protection degree	IP20																			
Main poles																				
Cable cross AC mm <sup>2</sup>	2 x 1,5 - 10			2,5 - 35		4 - 35	2x1-2,5		2 x 1,5 - 10		2,5-35	4 - 55			Busbar 18 x 4					
sections DC mm <sup>2</sup>	2 x 1,5 - 6			2,5 - 35		4 - 50	2x1-2,5		2 x 1,5 - 6		2,5-35	4 - 35			Screw M8					
Tightening torque Nm	1,4	2,3 - 2,7		5 - 6		8 - 9,6		1,4 - 1,6	2,3 - 2,7		5 - 6		8 - 9,6		17 - 20			35 - 42		
Mounting	DIN-rail / screws					Screws		DIN-rail / Screws				Screws		Screws						
Operation range coils U <sub>c</sub>	0,85 - 1,1																			
Power consumption of coils																				
AC inrush VA	90			250			180			250			350			360				
sealed VAW	9 / 3			18 / 4			18 / 6			18 / 4			5 / 5			6 / 6				
DC inrush W	5,5	5	5	230			11			230			350			360				
sealed W	5,5	5	5	4			11			4			5			6				
Switching time																				
AC make time ms	10 - 25			12 - 30		12 - 30		10 - 25			12 - 30		15 - 50		30 - 60			40 - 60		
release time ms	6 - 18			6 - 15		6 - 15		6 - 18			6 - 15		30 - 80		30 - 80			40 - 60		
DC make time ms	15 - 25			15 - 25		20 - 30		15 - 25			15 - 25		15 - 50		30 - 60			40 - 60		
realise time ms	60 - 80			10 - 25		10 - 25		60 - 80			10 - 25		30 - 80		30 - 80			40 - 60		
Maximum ambient temperature																				
Operation °C	-40 bis +40 (+70) <sup>2)</sup>																			
Storage °C	-40 bis +70																			
Short circuit protection																				
Coordination-Type „1“ max. fuse size gPV																				
600VDC A	63	63	80	-	-	160	-	-	-	-	-	160	200	250	-	-	-			
1000VDC A	-	-	-	-	-	-	12	63	100	-	160	160	200	250	315	400	500			
Coordination-Type „2“ max. fuse size gPV																				
600VDC A	50	50	63	80	100	125	-	-	-	100	-	-	-	-	-	-	-			
1000VDC A	-	-	-	80	100	-	-	50	80	100	125	-	-	-	-	-	-			
Short circuit current kA	3	3	3	3	3	5	3	3	3	5	5	10	10	10	10	10	10			

Data acc. to UL60947-4-1



Type		K(G)3DC- 12.. 20.. 48..			K3DC- 60.. 80..		K3PV- 80..	K3PV- 150..	200..	240..	K3PV- 300..	400..	450..
General Use I <sub>b</sub> [A]	600V DC	12	20	40	60	80	80	130	160	200	300	330	360
	1000V DC	-	-	-	30	60	80	130	160	200	300	330	360
Motor Control I <sub>b</sub> [A]	220-240V DC	-	12	20	38	55	72	89	106	140	173	206	255
	500V DC	-	12	16	34	51	67	83	99	123	164	205	246
	550-600V DC	-	12	16	38	46	61	90	111	148	185	222	294
	Fuse PK5	-	12	12	75	90	90	125	150	175	300	350	400
	max. short circuit current [kA]	-	5	5	5	5	5	10	10	10	10	10	10
	Voltage DC [V]	-	600	600	600	600	600	600	600	600	600	600	600

1) IP20 with terminal lugs

2) > 40° ... 1% / °C de-rating (eg. at 60°C 20% de-rating)

# Dimensions

## K3DC-20A00, K3DC-48A00

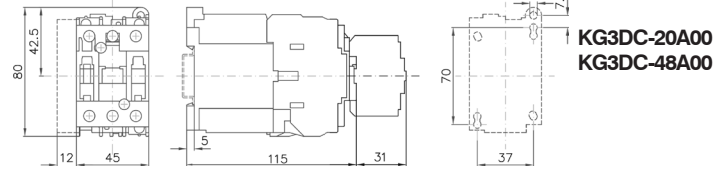
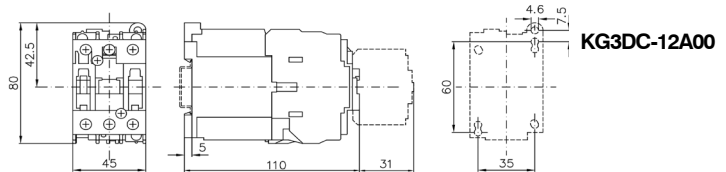
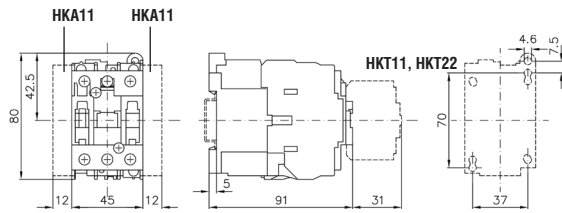

## K3DC-60A00(=), K3DC-80A00(=)

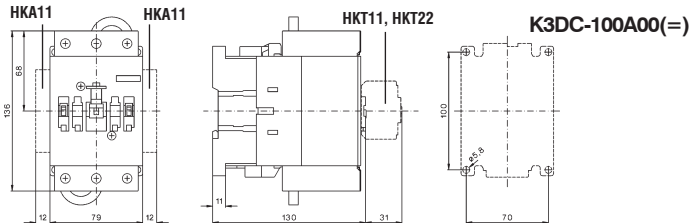
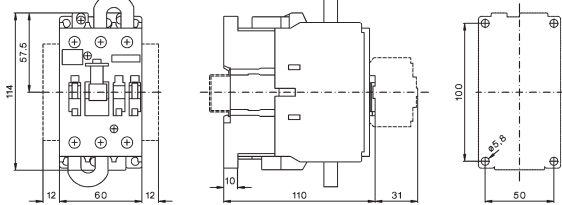

## K3PV-12A00, K3PV-30A00, K3PV-60A00

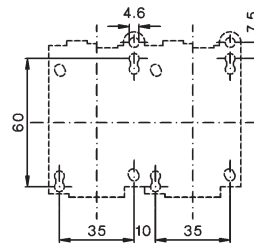
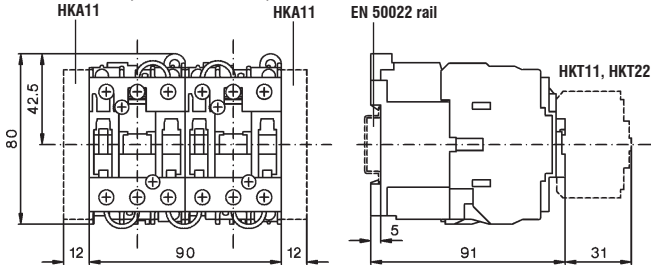

## KG3PV-12A00, KG3PV-30A00, KG3PV-60A00

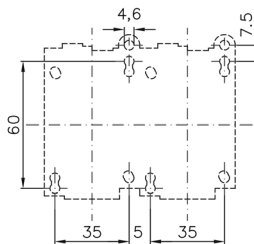
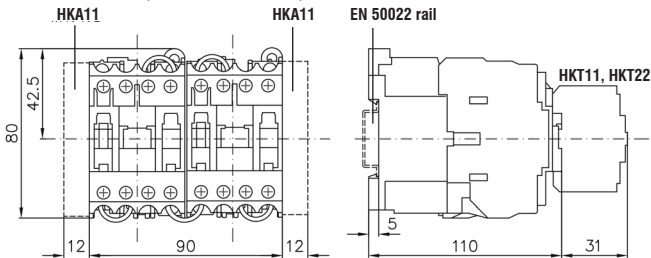

## K3PV-80A00(=)

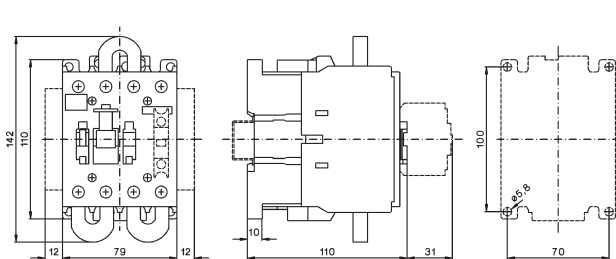

## K3PV-100A00(=)

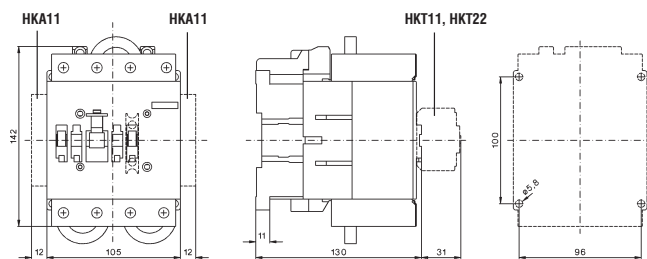

## K3PV-150A00(=), K3PV-200A00(=), K3PV-240A00(=)

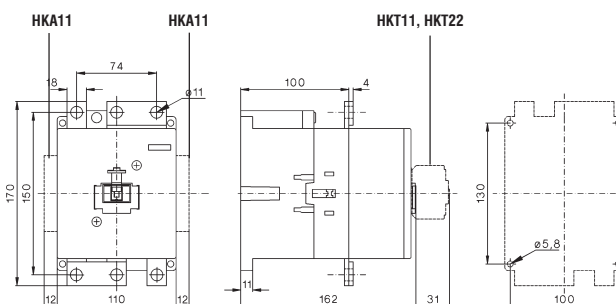

## K3PV-300A00(=), K3PV-400A00(=), K3PV-450A00(=)

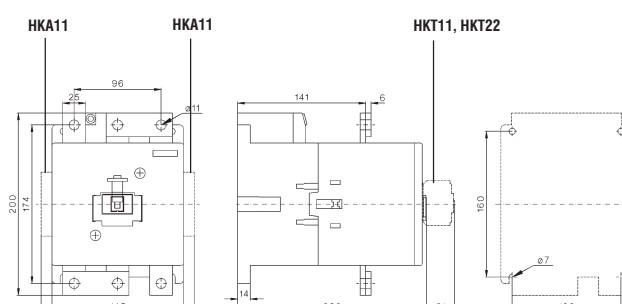

	<b>Contactors</b> RAST 5	147
	Contactor Relays	147
	Contactors	147
	<b>Accessories</b>	147
	Auxilliary Contact Blocks	147
	<b>Combinations</b>	148
	Contactors for Fuseless Load Feeder	148
	Contactors for Overload Relays	148
	<b>Industry Standard RAST 5</b>	
	Contactor-Housing	149
	Coil-Housing	150
	Auxilliary Contact Block-Housing	157
	<b>System Stocko RAST 5</b>	
	Contactor-Housing	151
Coil-Housing	152	
Auxilliary Contact Block-Housing	158	
<b>System Tyco RAST 5</b>		
Contactor-Housing	153	
Coil-Housing	154	
Auxilliary Contact Block-Housing	159	
<b>System Lumberg RAST 5</b>		
Contactor-Housing	155	
Coil-Housing	156	
Auxilliary Contact Block-Housing	160	
<b>Dimensions / Color Codes</b>	161	
<b>Technical Information</b>	162	

# RAST 5 - exclusiv for OEM-Partner

5 mm pitch connector system

## Advantages RAST 5 - Technology

- Time saving installation
- Easy assembly without tools
- Tailor-made sockets, custom - designed codes
- Ambient temperatures up to +90°C/194°F
- Smallest sizes
- Plug technology up to 32 A / 415 V
- color coding for power ratings
- color coding for coil voltages

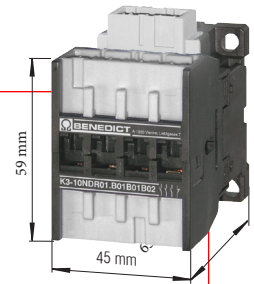

## RAST 5 - Accessories



Combining switchgears with plug-in connections and screw connections

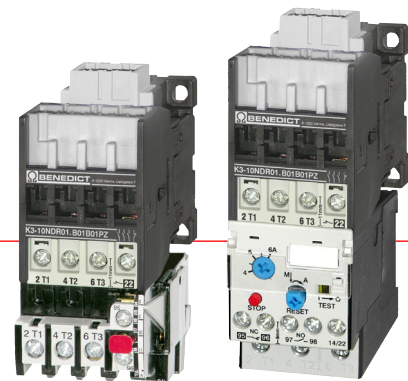



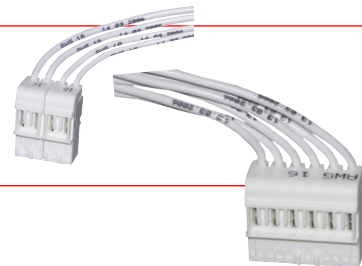

Contactors are available for plugs of many different producers



# Contactors, RAST 5

AC operated

Ratings AC2, AC3 380V 400V 415V <b>kW</b>	220V 230V kW	240V kW	Rated- Current AC1 415V A	Auxilliary Contacts built in		Auxilliary Contacts snap on HN10R..	<b>Type</b>	Coil Voltage	Code Housing Coil	Code Housing IN (L)	Code Housing OUT (T)	Pack pcs.	Weight kg/pc.
				NO	NC								
<b>● Contactor Relays</b>													
	-	-	10	4	-	2	<b>K3-07NDR40</b>					1	0,23
	-	-	10	2	2	2	<b>K3-07NDR22</b>					1	0,23
<b>● Contactors</b>													
	<b>4</b>	3	3	25	1	-	2	<b>K3-10NDR10</b>				1	0,23
	<b>4</b>	3	3	25	-	1	2	<b>K3-10NDR01</b>				1	0,23
	<b>5,5</b>	4	4	25	1	-	2	<b>K3-14NDR10</b>				1	0,23
	<b>5,5</b>	4	4	25	-	1	2	<b>K3-14NDR01</b>				1	0,23
	<b>7,5</b>	5	5	32	1	-	2	<b>K3-18NDR10</b>				1	0,23
	<b>7,5</b>	5	5	32	-	1	2	<b>K3-18NDR01</b>				1	0,23
	<b>11</b>	6	7	32	1	-	2	<b>K3-22NDR10</b>				1	0,23
	<b>11</b>	6	7	32	-	1	2	<b>K3-22NDR01</b>				1	0,23

## Auxilliary

### ● Auxilliary Contact Blocks

for Contactors	AC15 230V A	I <sub>th</sub> A	Contacts		<b>Type</b>	Pack pcs.	Weight kg/pc.	
			NO	NC				
	K3-..R..	3	10	1	-	<b>HN10R</b>	10	0,02
	K3-..R..	3	10	-	1	<b>HN01R</b>	10	0,02

Order Example for Contactors:

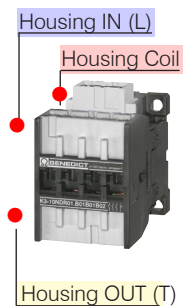
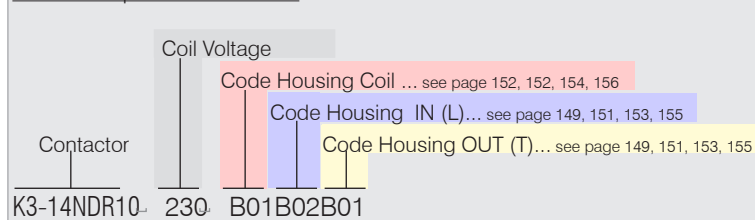

Technical data are subject to change without notice

# Contactors, RAST 5 Combinations

AC operated

Motor  
 AC2, AC3  
 380V AC3  
 400V 400V  
 415V 415V  
**kW A**





for  
 Overload Relays  
 U12/16E.. and U3/32...

## Type

Coil Voltage  
 Code Housing Coil  
 Code Housing IN (L)  
 Screw Connection OUT (T)

Pack Weight  
 pcs. kg/pcs.

● Contactors for Overload Relays

	4	10	U12/16E 0,18-..23 K3 and U3/32 0,18-..32	<b>K3-10NDR10</b>	..	..	..	<b>PZ</b>	1	0,23
	4	10	U12/16E 0,18-..23 K3 and U3/32 0,18-..32	<b>K3-10NDR01</b>	..	..	..	<b>PZ</b>	1	0,23
	5,5	14	U12/16E 0,18-..23 K3 and U3/32 0,18-..32	<b>K3-14NDR10</b>	..	..	..	<b>PZ</b>	1	0,23
	5,5	14	U12/16E 0,18-..23 K3 and U3/32 0,18-..32	<b>K3-14NDR01</b>	..	..	..	<b>PZ</b>	1	0,23
	7,5	18	U12/16E 0,18-..23 K3 and U3/32 0,18-..32	<b>K3-18NDR10</b>	..	..	..	<b>PZ</b>	1	0,23
	7,5	18	U12/16E 0,18-..23 K3 and U3/32 0,18-..32	<b>K3-18NDR01</b>	..	..	..	<b>PZ</b>	1	0,23
	11	22	U12/16E 0,18-..23 K3 and U3/32 0,18-..32	<b>K3-22NDR10</b>	..	..	..	<b>PZ</b>	1	0,23
	11	22	U12/16E 0,18-..23 K3 and U3/32 0,18-..32	<b>K3-22NDR01</b>	..	..	..	<b>PZ</b>	1	0,23

Pozidriv ... PZ  
 Torx ..... TX

Selection of Contactor-Housings for Standard plugs acc. **Industry Standard RAST 5**



Contactor Housings

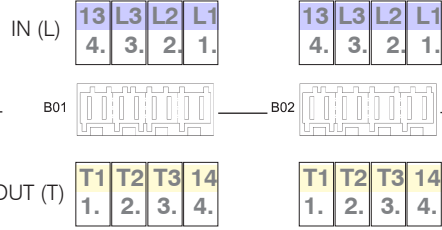

**Code Contactor-Housings** — B01 — B02 — B03 — B04 further housings on request →

**Standard plugs acc. Industry Standard RAST 5**



8-pole			
6-pole left			
6-pole right			
4-pole left		-0A-	
4-pole right		-0B-	
2-pole left			
		-0I-	-0C-
		-0L-	
			-0O-
			-0Q-
2-pole center left		-0A-	
		-0C-	
			-0K-
		-0O-	
		-0Q-	
2-pole center right			
			-0B-
		-0F-	
		-0K-	
			-0L-
2-pole right			
			-0B-
		-0F-	
			-0I-
		-0L-	
			-0L-

Order Example for Contactors:

Contactor  
 Coil Voltage  
 Code Housing Coil ...see page 150, 152, 154, 156  
 Code Housing IN (L)... see page 149, 151, 153, 155  
 Code Housing OUT (T)...see page 149, 151, 153, 155

K3-14NR10\_230\_B01 B02 B01

# Selection of Coil-Housings for Standard plugs acc. **Industry Standard RAST 5**



Coil-Housings

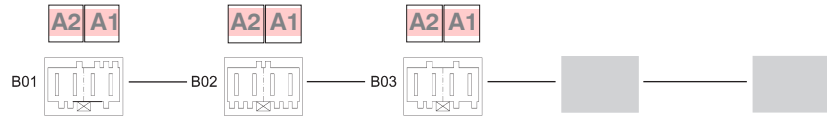

**Code Coil-Housings** ————— **B01** ————— **B02** ————— **B03** ————— **B04** ————— **B05** ————— further housings on request →

**Standard plugs acc. Industry Standard RAST 5**

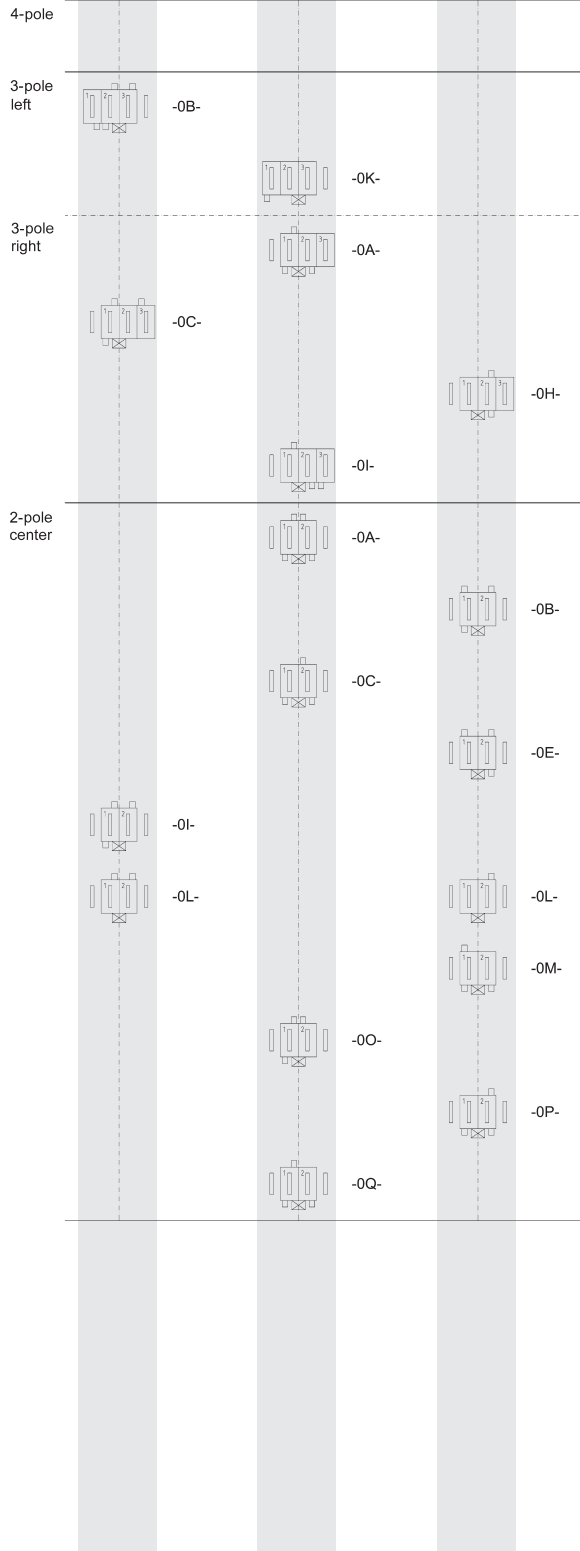

# Selection of Contactor-Housings for Standard plugs acc. **System Stocko RAST 5**

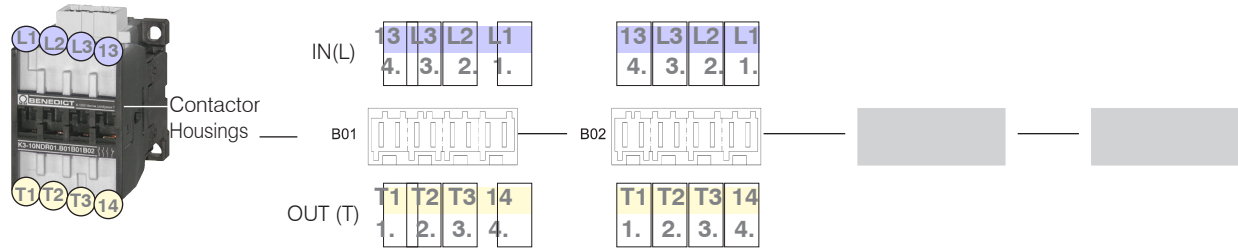

Code	Contactor-Housings	B01	B02	B03	B04	further housings on request
Standard plugs acc. System Stocko RAST 5	8-pole					-31-
	6-pole left					-34-
						-35-
						-38-
						-50-
						-65-
						-1F-
	6-pole right					-34-
						-35-
						-38-
						-50-
						-65-
					-1F-	
4-pole left					-14-	
					-16-	
					-53-	
					-60-	
					-73-	
					-75-	
4-pole right					-10-	
					-60-	
2-pole	see... Industry Standard RAST 5					

Order Example for Contactors:

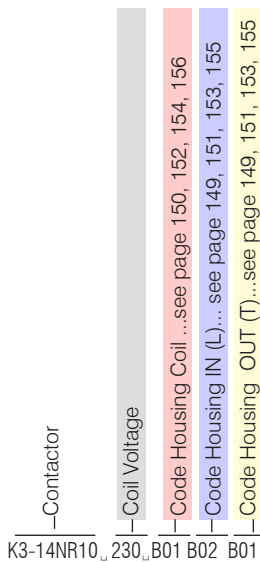

Selection of Coil-Housings for Standard plugs acc. **System Stocko RAST 5**



Coil-Housings –

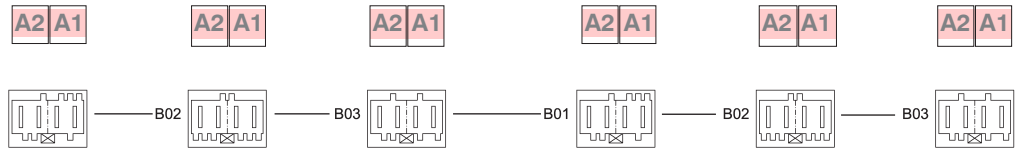

Code Coil-Housings	B01	B02	B03	B01	B02	B03
Standard plugs acc. System Stocko RAST 5	4-pole	-42-	-64-	3-pole right	-02-	-02-
		-78-	-78-		-04-	-03-
	-79-		-78-			-18-
			-79-			
3-pole left			-01-	-19-		
			-05-	-21-		
		-12-				-28-
		-16-		-47-		
			-30-		-52-	-52-
			-32-		-53-	
	-33-					-64-
			-35-		-66-	
	-36-			-71-		
		-40-				-73-
			-44-		-74-	
			-48-		-75-	
	-49-			2-pole center see... Industry Standard RAST 5		
	-51-					
	-72-	-72-	-72-			
		-75-	-75-			

# Selection of Contactor-Housings for Standard plugs acc. **System Tyco RAST 5**



Contactor Housings

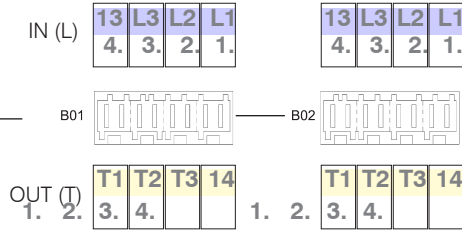

## Code Contactor-Housings — B01 — B02 — B03 — B04 further housings on request ▶

Standard plugs acc. System Tyco RAST 5



	B01	B02	B03	B04
8-pole				
6-pole left		928151-6 2-928344-6		
6-pole right				
4-pole left		928344-4		
4-pole right				4-928344-4
2-pole left				928344-2 3-964951-2
		2-964951-2 928343-2		
				964951-2 4-928344-2
2-pole center left		928344-2		
		3-964951-2 4-928344-2		
2-pole center right				2-928344-2 928343-2
2-pole right				2-928344-2 2-964951-2 928343-2 928343-2

Order Example for Contactors:









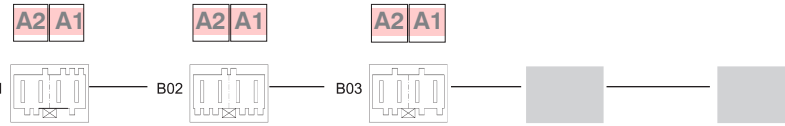

Contactor	Coil Voltage	Code Housing Coil ...see page 150, 152, 154, 156	Code Housing IN (L)... see page 149, 151, 153, 155	Code Housing OUT (T)...see page 149, 151, 153, 155
K3-14NR10	230	B01	B02	B01

Selection of Coil-Housings for Standard plugs acc. **System Tyco RAST 5**



Coil  
Housings –



Code Coil-Housings	B01	B02	B03	B04	B05	further housings on request
4-pole						
3-pole left						
3-pole right			928344-3			
2-pole center			928344-2		2-928344-2	
			3-964951-2		6-928344-2	
			2-964951-2			
			928343-2		928343-2	
			964951-2			
			4-928344-2			

Standard plugs  
acc.  
System Lumberg RAST 5



# Selection of Contactor-Housings for Standard plugs acc. **System Lumberg RAST 5**

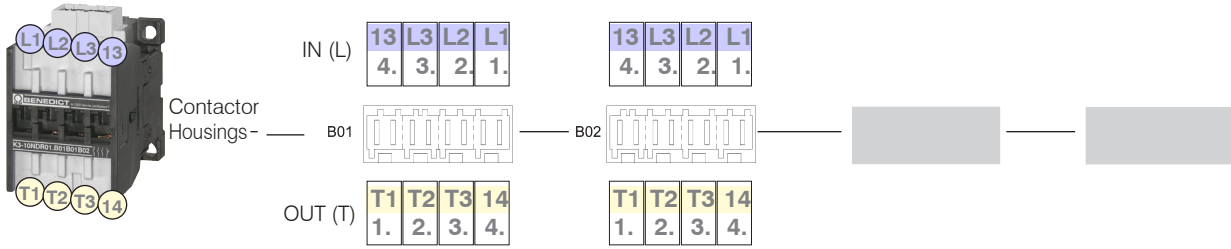

## Code Contactor-Housings B01 B02 B03 B04 further housings on request

Standard plugs acc. System Lumberg RAST 5



	B01	B02	B03	B04
8-pole				
6-pole left				-10-
6-pole right				
4-pole left				-01-
4-pole right				-02-
2-pole left				-01- -03-
2-pole center left				-09- -01- -03-
2-pole center right				-10- -02- -06-
2-pole right				-10- -02- -06- -09-

Order Example for Contactors:

Contactor	K3-14NR10
Coil Voltage	230
Code Housing Coil ...see page 150, 152, 154, 156	B01
Code Housing IN (L)... see page 149, 151, 153, 155	B02
Code Housing OUT (T)...see page 149, 151, 153, 155	B01

Selection of Coil-Housings for Standard plugs acc. **System Lumberg RAST 5**

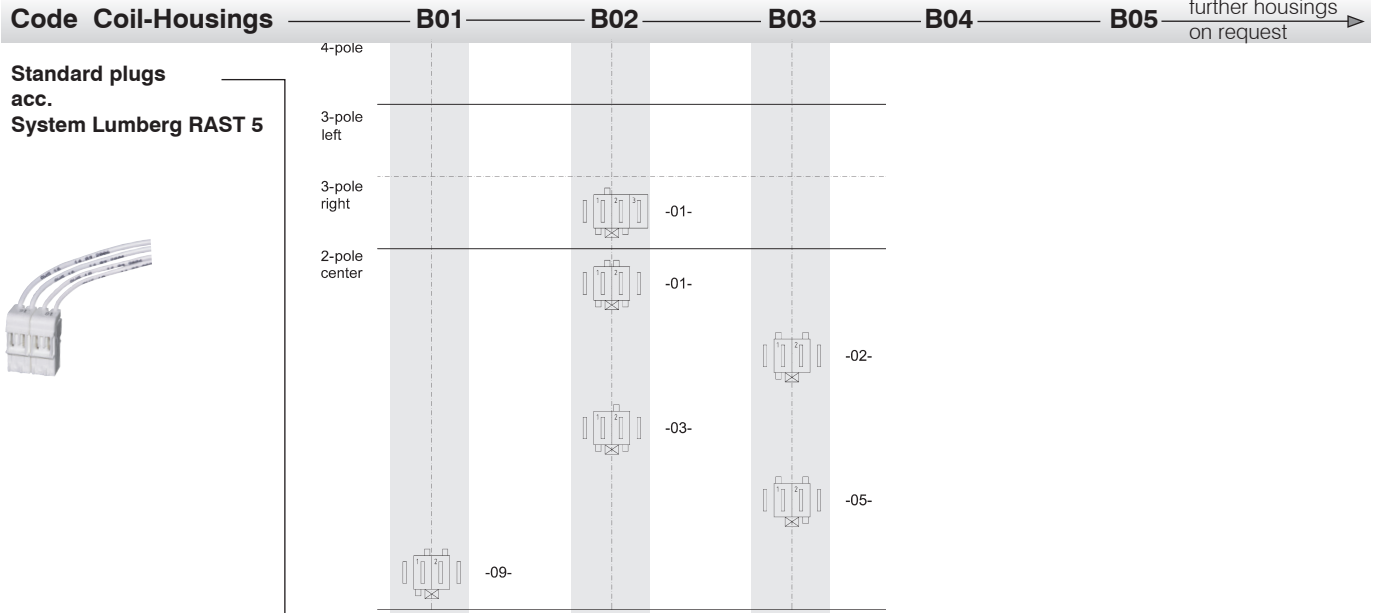
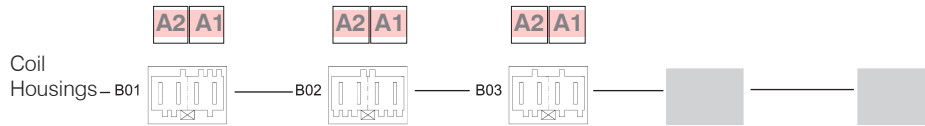

Selection of Auxiliary Contact Block-Housings for Standard plugs acc. **Industry Standard RAST 5**

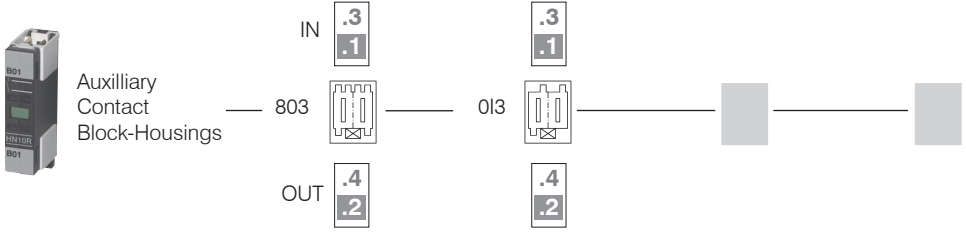

**Code Auxilliary-Contact Block-Housings** 803 013 further housings on request

Standard plugs acc. Industry Standard RAST 5

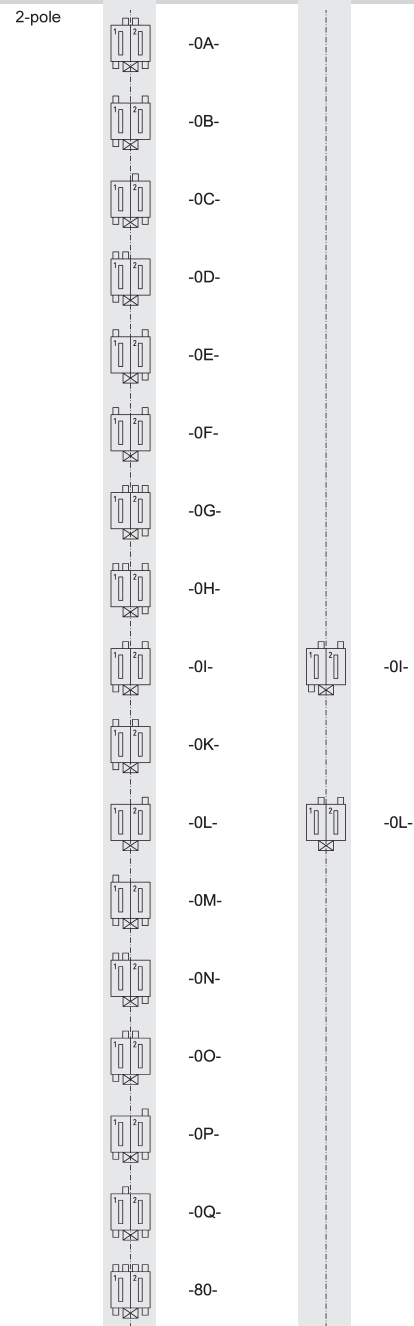

Order Example for Aux. Contact Blocks:

- Auxilliary Contact Block
  - Code Aux. Block Housing IN (1,.3)
  - Code Aux. Block Housing OUT (2,.4)
- HN10R-803013

Selection of Auxiliary Contact Block-Housings for Standard plugs acc. **System Stocko RAST 5**

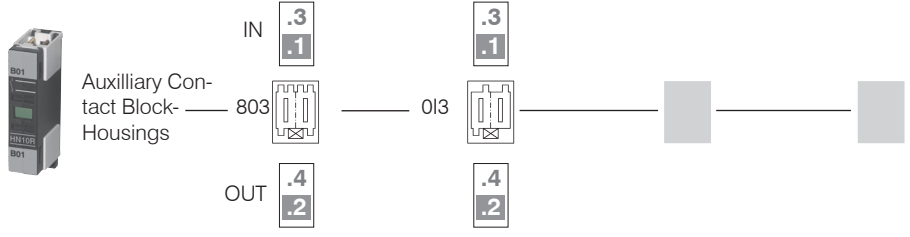

**Code Auxilliary-Contact Block-Housings**

Standard plugs acc. System Stocko RAST 5

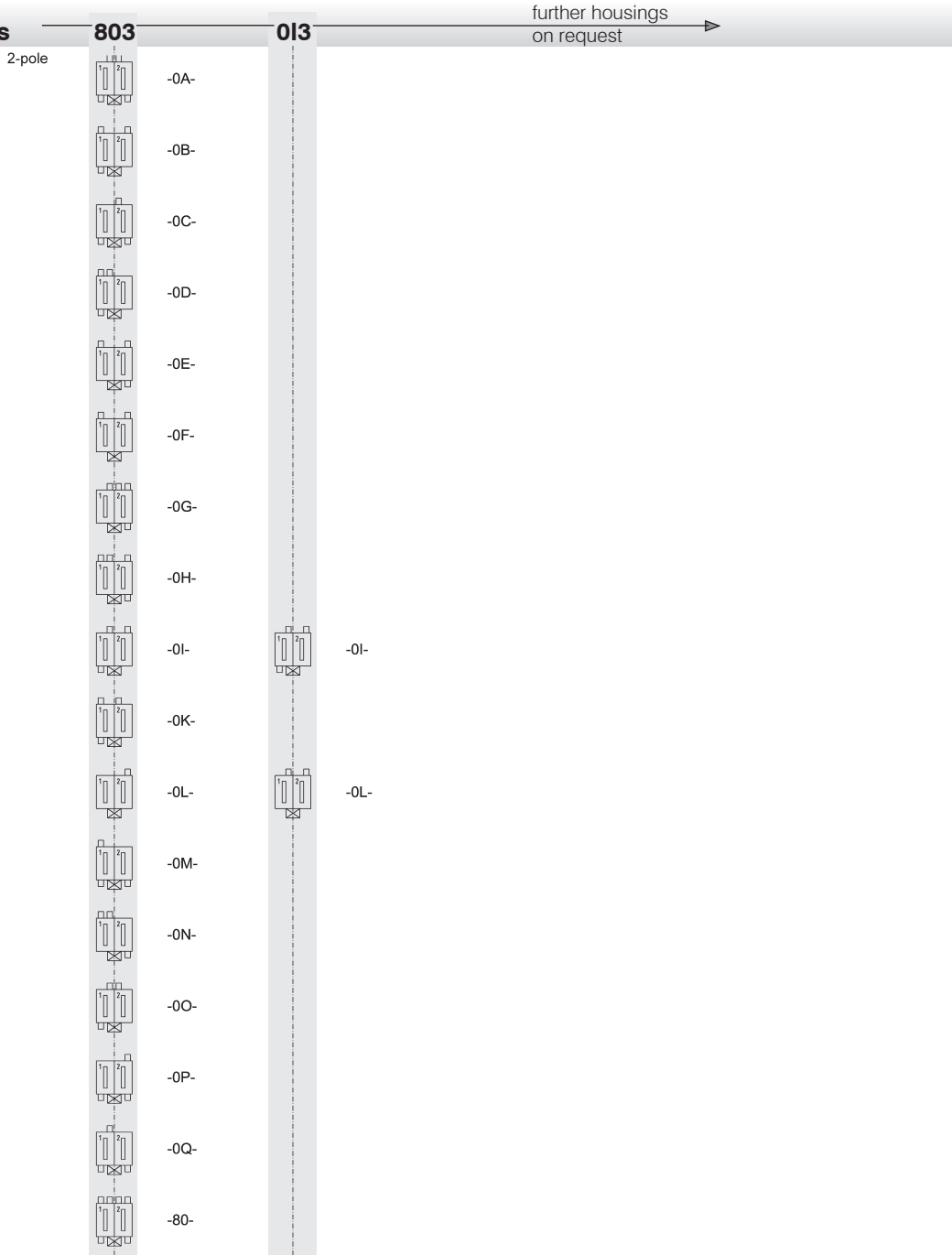

Order Example for Aux. Contact Blocks:

- Auxiliary Contact Block
- Code Aux. Block Housing IN (1,3)
- Code Aux. Block Housing OUT (2,4)

HN10R 803013

Selection of Auxiliary Contact Block-Housings for Standard plugs acc. **System Tyco RAST 5**

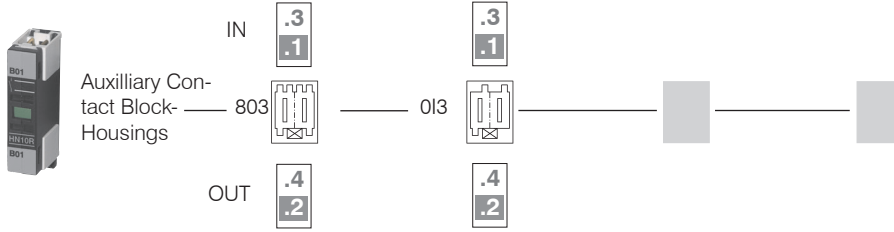

**Code Auxilliary-Contact Block-Housings**

**803**

**013**

further housings on request →

**Standard plugs acc. System Tyco RAST 5**



2-pole	803	013
	928344-2	
	2-928344-2	
	3-964951-2	
	6-928344-2	
	5-928344-2	
	3-928344-2	
	2-964951-2	2-964951-2
	928343-2	928343-2
	964951-2	
	4-928344-2	

Order Example for  
Aux. Contact Blocks:

—Auxiliary Contact Block  
 —Code Aux. Block Housing IN (1,3)  
 —Code Aux. Block Housing OUT (2,4)  
 HN10R-803013

- Contactor, Motor-Starter
- Circuit Breakers
- Manual Motor-Starters
- Switches
- AC-Main Switches
- DC-Switch Disconnect
- Push Buttons
- Representatives, Suppliers

Selection of Auxiliary Contact Block-Housings for Standard plugs acc. **System Lumberg RAST 5**

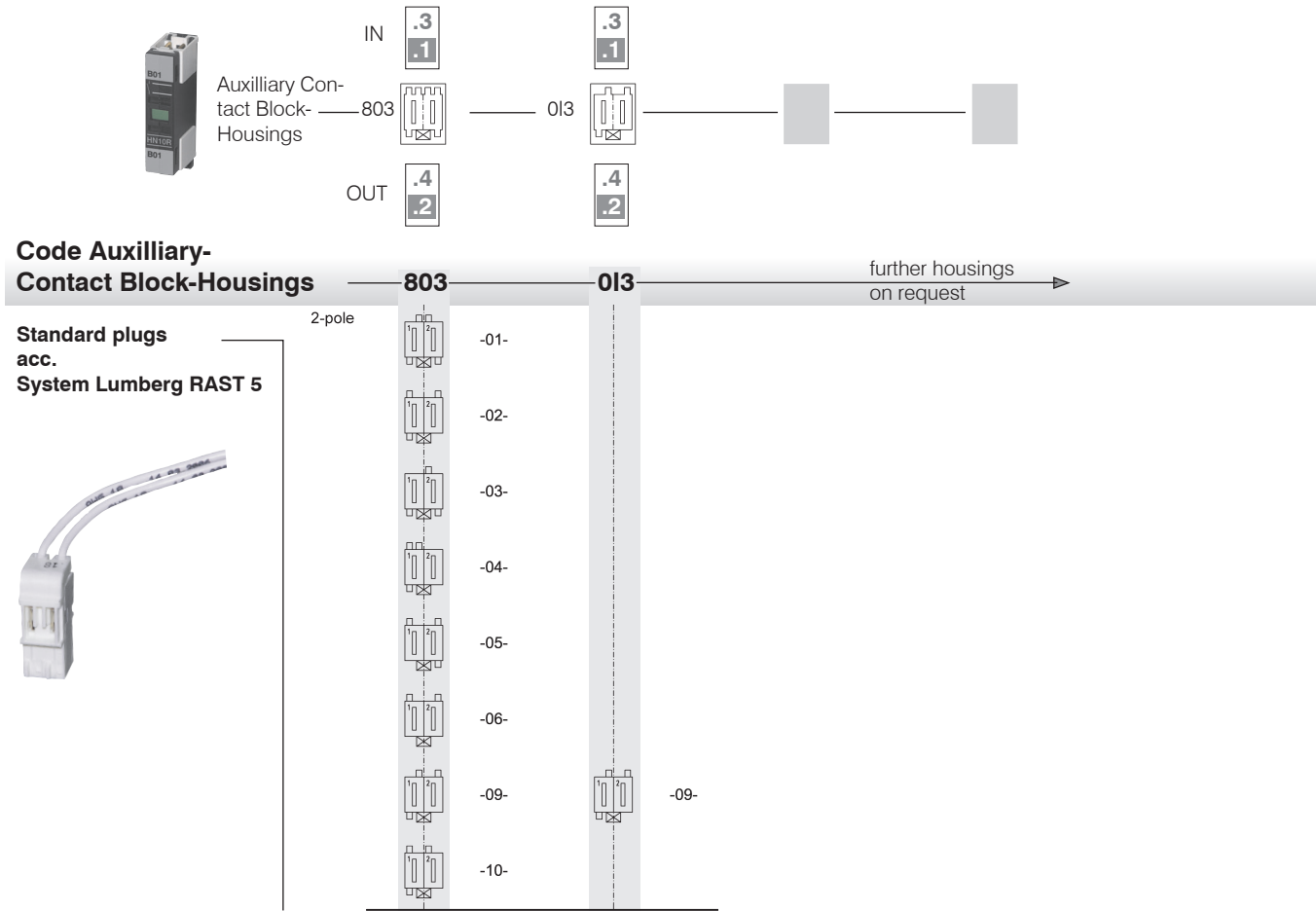

Order Example for  
Aux. Contact Blocks:

- Auxiliary Contact Block
- Code Aux. Block Housing IN (1,3)
- Code Aux. Block Housing OUT (2,4)

HN10R 803013

Data acc. to IEC 60947-4-1, VDE 0660

Main Contacts	Type		K3-07NDR	K3-10NDR	K3-14NDR	K3-18NDR	K3-22NDR
<b>Rated insulation voltage <math>U_i</math></b> <sup>1)</sup>	V~		415	415	415	415	415
<b>Making capacity <math>I_{eff}</math></b> at $U_e = 415V\sim$	A		-	200	200	200	200
<b>Breaking capacity <math>I_{eff}</math></b> at $U_e = 415V\sim$ $\cos\varphi = 0,65$	A		-	180	180	200	200
<b>Utilization category AC1</b>							
<b>Switching of resistive load</b>							
Rated operational current $I_e (=I_{th})$	415V	<b>A</b>	<b>10</b>	<b>25</b>	<b>25</b>	<b>32</b>	<b>32</b>
Rated operation power of three-phase resistive loads	220V	kW	-	9,5	9,5	12,2	12,2
50-60Hz, $\cos\varphi = 1$	230V	kW	-	9,9	9,9	12,7	12,7
	240V	kW	-	10,4	10,4	13,3	13,3
	380V	kW	-	16,4	16,4	21,0	21,0
	400V	kW	-	17,3	17,3	22,1	22,1
	415V	kW	-	17,9	17,9	23,0	23,0
Rated operational current $I_e (=I_{th})$	415V	A	6	25	25	32	32
Rated operation power of three-phase resistive loads	220V	kW	-	9,5	9,5	12,2	12,2
50-60Hz, $\cos\varphi = 1$	230V	kW	-	9,9	9,9	12,7	12,7
	240V	kW	-	10,4	10,4	13,3	13,3
	380V	kW	-	16,4	16,4	21,0	21,0
	400V	kW	-	17,3	17,3	22,1	22,1
	415V	kW	-	17,9	17,9	23,0	23,0
Minimum cross-section of conductor at load with $I_e (=I_{th})$		mm <sup>2</sup>	2 x 1,5 <sup>2</sup>	2 x 1,5 <sup>2</sup>	2 x 1,5 <sup>2</sup>	2 x 2,5 <sup>2</sup>	2 x 2,5 <sup>2</sup>
<b>Utilization category AC2 and AC3</b>							
<b>Switching of three-phase motors</b>							
Rated operational current $I_e$ open and enclosed	220V	A	-	12	15	18	22
	230V	A	-	11,5	14,5	18	22
	240V	A	-	11	14	18	22
	<b>380-400V</b>	<b>A</b>	-	<b>10</b>	<b>14</b>	<b>18</b>	<b>22</b>
	415V	A	-	9	14	18	22
Rated operational power of three-phase motors	220-230V	kW	-	3	4	5	6
50-60Hz	240V	kW	-	3	4	5	7
	<b>380-400V</b>	<b>kW</b>	-	<b>4</b>	<b>5,5</b>	<b>7,5</b>	<b>11</b>
	415V	kW	-	4,5	6	8,5	12
<b>Auxilliary Contacts</b>							
<b>Rated insulation voltage <math>U_i</math></b>	V~		415	415	415	415	415
<b>Thermal rated current <math>I_{th}</math></b> up to 415V							
Ambient temperature	40°C	A	10	10	10	10	10
	60°C	A	6	6	6	6	6
<b>Utilization category AC15</b>							
Rated operational current $I_e$	220-240V	A	3	3	3	3	3
	380-415V	A	2	2	2	2	2
<b>Utilization category DC13</b>							
Rated operational current $I_e$	60V	A	3,5	3,5	3,5	3,5	3,5
	110V	A	0,5	0,5	0,5	0,5	0,5
	220V	A	0,1	0,1	0,1	0,1	0,1
<b>Short circuit protection</b>	gL (gG)	A	20	20	20	20	20

1) Suitable for: earthed -neutral systems, overvoltage category I to III, pollution degree 3 (Industry-Standard):  $U_{imp} = 4kV$ .  
Data for other conditions on request.

Data acc. to IEC 60947-4-1, VDE 0660

Main Contacts			Type	K3-07NDR	K3-10NDR	K3-14NDR	K3-18NDR	K3-22NDR
<b>Maximum ambient temperature</b>								
Operation with thermal overload relay	open	°C				-40 up to +60 (+90) <sup>1)</sup>		
	enclosed	°C				-40 up to +40		
	open	°C				-25 up to +60		
	enclosed	°C				-25 up to +40		
Storage		°C				-50 up to +90		
<b>Short circuit protection</b> without thermal O/L relay								
Rated short circuit current	„r“	kA	1	3	3	3	3	3
	„Iq“	kA	-	-	-	-	-	-
Coordination-Type „1“ acc. to IEC 947-4-1, Contact welding without hazard of persons								
max. fuse size	gL (gG)	A	20	63	63	63	63	63
Coordination-Type „2“ acc. to IEC 947-4-1, light Contact welding accepted								
max. fuse size	gL (gG)	A		25	35	35	35	35
Contact welding not accepted								
max. fuse size	gL (gG)	A		16	16	16	16	16
for Contactors with thermal overload relay the device with the smaller admissible backup fuse (contactor or thermal overload relay) determines the fuse size.								
<b>Frequency of operations z</b>								
Contactors without thermal overload relay								
	without load	1/h	10000	10000	10000	10000	10000	10000
	AC3, I <sub>e</sub>	1/h		600	600	600	600	600
	AC4, I <sub>e</sub>	1/h		120	120	120	120	120
	DC3, I <sub>e</sub>	1/h		600	600	600	600	600
<b>Mechanical life</b>								
AC-operated		S x 10 <sup>6</sup>	10	10	10	10	10	10
DC-operated		S x 10 <sup>6</sup>	10	10	10	10	10	10
<b>Short time current</b>	10sec.-current	A		96	120	144	176	
<b>Power loss</b> per pole	at I <sub>e</sub> /AC3 400V	W		0,21	0,35	0,5	0,75	
<b>Resistance to shock acc. to IEC 68-2-27</b>								
Shock time 20ms sine-wave	NO	g				10		
	NC	g				6		
Control Circuit								
<b>Power consumption of coils</b>								
AC operated	inrush	VA				33-45		
	sealed	VA				7-10		
		W				2,6-3		
DC operated	inrush	W				75		
	sealed	W				2		
<b>Operating range of coils</b>								
in multiples of control voltage U <sub>s</sub>								
	AC operated					0,85-1,1		
	DC operated					0,8-1,1		
<b>Switching time</b> at control voltage U <sub>s</sub> ± 10% <sup>2) 3)</sup>								
AC operated	make time	ms				8-16		
	release time	ms				5-13		
	arc duration	ms				10-15		
DC operated	make time	ms				8-12		
	release time	ms				8-13		
	arc duration	ms				10-15		

1) With reduced control voltage range 0,9 bis 1,0 x U<sub>s</sub> and with reduced rated current I<sub>e</sub> /AC1, no deratings for I<sub>e</sub> /AC3 values.

2) Total breaking time = release time + arc duration

3) Values for delay of the release time of the make contact and the make time of the break contact will be increased, if magnet coils are protected with coil suppressor (Varistor, RC-Unit, Diode-Unit).

Data acc. to UL508

Main Contacts (cULus)		Type	K3-10NDR	K3-14NDR	K3-18NDR	K3-22NDR
Bemessungsbetriebsstrom „General Use“		A	25	25	30	30
<b>Motor DOL 3-phase</b> at 60Hz						
Rated operational current	415V	A	10	14	18	22
Rated operational power	110-120V	hp	1½	2	2	3
	200-208V	hp	3	3	5	5
	220-240V	hp	3	3	5	5
	265-277V	hp	3	5	7½	7½
	380-415V	hp	5	5	10	10
<b>Motor DOL 1-phase</b> (2-pole break) at 60Hz						
Rated operational current	415V	A	10	14	18	22
Rated operational power of AC motor at 60Hz (1ph)	110-120V	hp	½	¾	1	1½
	200-208V	hp	1	1½	2	3
	220-240V	hp	1½	2	3	3
	265-277V	hp	2	3	3	3
	380-415V	hp	3	3	5	5
Fuses		A	30	40	50	50
Suitable for use on a capability of delivering not more than (SCCR)	rms	A	5000	5000	5000	5000
		V	415	415	415	415
Auxilliary Contacts (cULus)			A300	A300	A300	A300

## Accessories

Data acc. to IEC 60947-5-1, VDE 0660

Auxilliary Contacts		Type	HN10R	HN01R
<b>Rated insulation voltage <math>U_i</math></b>		V~	415	415
<b>Thermal rated current <math>I_{th}</math></b> up to 415V				
Ambient temperature	max. 40°C	A	10	10
	max. 60°C	A	6	6
<b>Frequency of operations <math>z</math></b>		1/h	3000	3000
<b>Mechanical life</b>		S x 10 <sup>6</sup>	10	10
<b>Power loss</b> per pole at $I_e/AC1$		W	0,5	0,5
<b>Utilization category AC15</b>				
Rated operational betriebsstrom $I_e$	220-240V	A	3	3
	380-415V	A	2	2
<b>Utilization category DC13</b>				
Bemessungs- current $I_e$	60V	A	2	2
	110V	A	0,4	0,4
	220V	A	0,1	0,1
<b>Short circuit protection</b>				
short circuit current 1kA, contact welding not accepted				
max. fuse size	gL (gG)	A	20	20
Data acc. to UL508				
Rated operational current „General Use“		A	10	10
Rated operational voltage	max.	V~	300	300
<b>Auxiliary Contacts</b>			A300	A300

# Dimensions

## K3-..NDR.. +HN..R

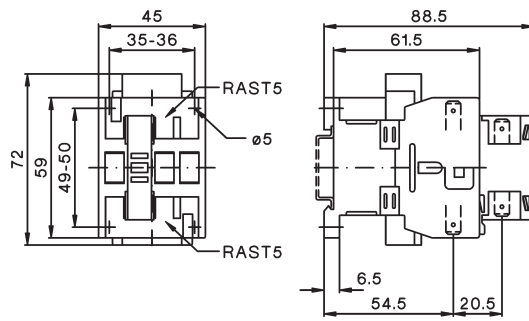



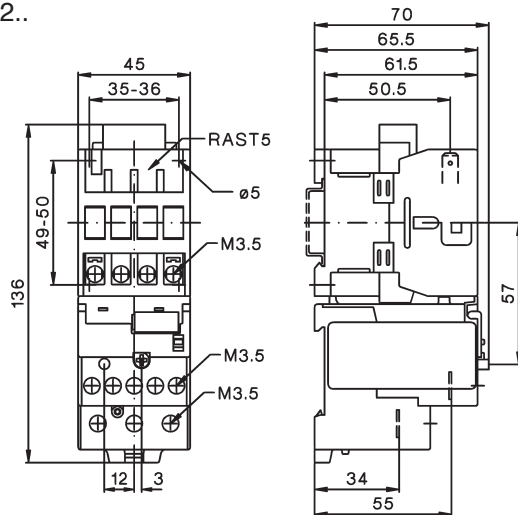

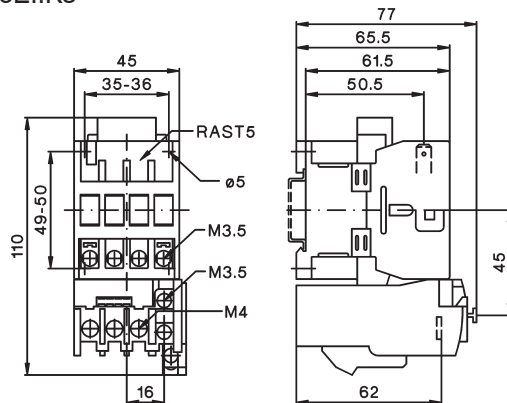

## K3-..NDR.....PZ + U3/32..



## K3-..NDR.....PZ + U12/16E..K3

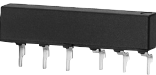

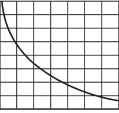
Technical data are subject to change without notice

Index	Page
	<b>Circuit-Breakers M4</b> for motor protection 166
	<b>Auxiliary contacts</b> Signalling switch Auxiliary releases 167
	<b>Insulated 3-pole busbar system</b> Terminal block 168
	<b>DIN-rail adapters</b> Busbar adapters Link modules 169
	<b>Technical Data</b> 171
	<b>Characteristics</b> Installation Accessories 176 178
	<b>Dimensions</b> 182

## Circuit Breakers M4 for Motor Control

Rated Current $I_n$ A	Suitable for motors <sup>1)</sup> 3~400V kW	Setting range Thermal Overload Release A	Instantaneous Short Circuit Release A	Short Circuit Breaking Capacity at 3~400V kA ( $I_{cu}$ )	Type	Pack pcs.	Weight approx. kg/pc.
-----------------------------	---	--	--	---	------	--------------	-----------------------------

### Circuit Breaker M4-32T-..



switch type

0,16	-	0,10 – 0,16	2,1	100	M4-32T-0,16	1	0,32
0,25	0,06	0,16 – 0,25	3,3	100	M4-32T-0,25	1	0,32
0,4	0,09	0,25 – 0,4	5,2	100	M4-32T-0,4	1	0,32
0,63	0,18	0,4 – 0,63	8,2	100	M4-32T-0,63	1	0,32
1	0,25	0,63 – 1	13	100	M4-32T-1	1	0,32
1,6	0,55	1 – 1,6	20,8	100	M4-32T-1,6	1	0,32
2,5	0,75	1,6 – 2,5	32,5	100	M4-32T-2,5	1	0,32
4	1,5	2,5 – 4	52	100	M4-32T-4	1	0,32
6	2,2	4 – 6	78	100	M4-32T-6	1	0,32
8	3	5 – 8	104	100	M4-32T-8	1	0,32
10	4	6 – 10	130	50	M4-32T-10	1	0,32
13	5,5	9 – 13	169	50	M4-32T-13	1	0,32
17	7,5	11 – 17	221	20	M4-32T-17	1	0,32
22	7,5	14 – 22	286	15	M4-32T-22	1	0,32
26	11	18 – 26	338	15	M4-32T-26	1	0,32
32	15	22 – 32	416	15	M4-32T-32	1	0,32
40	18,5	28 – 40	520	10	M4-32T-40	1	0,32

### Circuit Breaker M4-32R-..



rotary type

0,16	-	0,10 – 0,16	2,1	100	M4-32R-0,16	1	0,36
0,25	0,06	0,16 – 0,25	3,3	100	M4-32R-0,25	1	0,36
0,4	0,09	0,25 – 0,4	5,2	100	M4-32R-0,4	1	0,36
0,63	0,18	0,4 – 0,63	8,2	100	M4-32R-0,63	1	0,36
1	0,25	0,63 – 1	13	100	M4-32R-1	1	0,36
1,6	0,55	1 – 1,6	20,8	100	M4-32R-1,6	1	0,36
2,5	0,75	1,6 – 2,5	32,5	100	M4-32R-2,5	1	0,36
4	1,5	2,5 – 4	52	100	M4-32R-4	1	0,36
6	2,2	4 – 6	78	100	M4-32R-6	1	0,36
8	3	5 – 8	104	100	M4-32R-8	1	0,36
10	4	6 – 10	130	100	M4-32R-10	1	0,36
13	5,5	9 – 13	169	100	M4-32R-13	1	0,36
17	7,5	11 – 17	221	50	M4-32R-17	1	0,36
22	7,5	14 – 22	286	50	M4-32R-22	1	0,36
26	11	18 – 26	338	50	M4-32R-26	1	0,36
32	15	22 – 32	416	50	M4-32R-32	1	0,36
40	18,5	28 – 40	520	40	M4-32R-40	1	0,36

### Circuit Breaker M4-63R-..



rotary type

26	12,5	18 – 26	338	50	M4-63R-26	1	1,0
32	15	22 – 32	416	50	M4-63R-32	1	1,0
40	18,5	28 – 40	520	50	M4-63R-40	1	1,0
50	22	34 – 50	650	50	M4-63R-50	1	1,0
63	30	45 – 63	819	50	M4-63R-63	1	1,0

### Circuit Breaker M4-100R-..



rotary type

63	30	45 – 63	819	50	M4-100R-63	1	2,2
75	37	55 – 75	975	50	M4-100R-75	1	2,2
90	45	70 – 90	1170	50	M4-100R-90	1	2,2
100	-	80 – 100	1300	50	M4-100R-100	1	2,2

1) Approximate values of standard motors

# Accessories

Contacts		Rated Operational Current			Type	Pack pcs.	Weight approx. kgpc
NO	NC	AC15 24V A	AC1 240V A	AC1 240V A			

## Transverse Auxiliary Contact Block, max. 1 pc. per circuit-breaker <sup>1)</sup>



1	1	3	2	5	M4 HQ11	1	0,02
2	-	3	2	5	M4 HQ20	1	0,02
-	2	3	2	5	M4 HQ02	1	0,02

## Auxiliary Contact Block for left hand side mounting, 1 or 2 pcs. per circuit-breaker <sup>1)</sup>



1	1	6	4	10	M4 HS11	1	0,03
2	-	6	4	10	M4 HS20	1	0,03
-	2	6	4	10	M4 HS02	1	0,03

## Alarm Switch (any tripping) for left hand side mounting, max. 1 pc. per circuit-breaker <sup>1)</sup>



1	1	for M4-32T, -32R	6	4	10	M4 MA11	1	0,04
1	1	for M4-63R, -100R	6	4	10	M4 MA11 63	1	0,04

## Alarm Switch (short circuit) for left hand side mounting, max. 1 pc. per circuit-breaker <sup>1)</sup>



1	1		6	4	10	M4 M11	1	0,04
---	---	--	---	---	----	--------	---	------

Operates in case of short circuit accidents that is over 20 times of the rated current of the circuit breaker.

## Undervoltage Releases for right hand side mounting, max. 1 pc. per circuit-breaker <sup>1)</sup>

Trips the circuit-breaker when the voltage is interrupted. Prevents the motor from being restarted accidentally when the voltage is restored, suitable for EMERGENCY STOP acc. to IEC 60204



24V 50Hz, 28V 60Hz	M4 U24	1	0,11
110-127V 50Hz, 120V 60Hz	M4 U110	1	0,11
220-230V 50Hz, 240-260V 60Hz	M4 U230	1	0,11
240V 50Hz, 277V 60Hz	M4 U240	1	0,11
380-400V 50Hz, 440-460V 60Hz	M4 U400	1	0,11
415-440V 50Hz, 460-480V 60Hz	M4 U415	1	0,11

## Shunt Releases for right hand side mounting, max. 1 pc. per circuit-breaker <sup>1)</sup>

Trips the circuit-breaker when the release coil energized.  
**100% ON max. 5sec. ON**



20-24V 50Hz, 28V 60Hz	20-70V 50/60Hz DC	M4 A24	1	0,12
75-127V 50Hz, 120V 60Hz	75-190V 50/60Hz DC	M4 A110	1	0,12
190-230V 50Hz, 240-260V 60Hz	190-330V 50/60Hz DC	M4 A230	1	0,12
200-240V 50Hz, 277V 60Hz	200-330V 50/60Hz DC	M4 A240	1	0,12
300-400V 50Hz, 440-460V 60Hz	300-500V 50/60Hz DC	M4 A400	1	0,12
330-440V 50Hz, 460-480V 60Hz	330-500V 50/60Hz DC	M4 A415	1	0,12

## Enclosure for circuit breaker M4 32R protection degree IP65





Plastic enclose with rotary operating mechanism black-grey lockable, with N- and PE-terminal space for 1 transverse and side aux. contact + release	M4 32R PFH4	1	0,53
Enclose with rotary operating mechanism yellow - red, lockable with N- and PE-terminal space for 1 transverse and side aux. contact + release	M4 32R PFHN4	1	0,53

1) Number and position see page 179

## Accessories and Busbars



			for circuit- breaker	Type	Pack pcs.	Weight approx. kg/pc.
--	--	--	----------------------------	------	--------------	-----------------------------

### Accessories

	Scale cover sealable	for covering the current setting scale	M4-32...100	M4 K	10	0,003
	Spade terminal block	up to 600V acc. UL 489	M4-32R	M4 32R E	on request	
	Insulation barriers for increased distances and clearances acc. to UL Type "E", 2 pcs. per device (on input side)	up to 600V acc. UL 489	M4-100	M4 100 E	2	0,01

### Door-coupling rotary mechanisms IP65

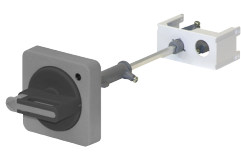



The door locking device prevents accidental opening of the cubicle door in the ON position of the circuit-breaker. The OFF position can be locked with up to 3 padlocks.

	Door-coupling rotary mechanism black	extension shaft 115mm	M4-32R	M4 32R EH1 115	1	0,1
		extension shaft 315mm	M4-32R	M4 32R EH1 315	1	0,2
		extension shaft 115mm	M4-63R	M4 63R EH1 115	1	0,1
		extension shaft 315mm	M4-63R	M4 63R EH1 315	1	0,2
		extension shaft 115mm	M4-100R	M4 100R EH1 115	1	0,1
	Emergency-Stop Door-coupling rotary mechanism; red/yellow	extension shaft 115mm	M4-32R	M4 32R EHN1 115	1	0,1
		extension shaft 315mm	M4-32R	M4 32R EHN1 315	1	0,2
		extension shaft 115mm	M4-63R	M4 63R EHN1 115	1	0,1
		extension shaft 315mm	M4-63R	M4 63R EHN1 315	1	0,2
		extension shaft 115mm	M4-100R	M4 100R EHN1 115	1	0,1
		extension shaft 315mm	M4-100R	M4 100R EHN1 315	1	0,2

			Protection degree	Type	Pack pcs.	Weight kg/pc.
--	--	--	----------------------	------	--------------	------------------

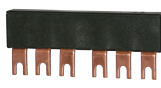
### Insulated 3-phase busbar system

For feeding several modular circuit-breakers M4-32. on standard mounting rails, insulated  
Rated operational voltage max. 690 V, rated current 63 A, with **spade connection**, modular spacing 45mm (54mm on request)

	3-phase busbars	for 2 circuit-breakers	IP20	M4 32 S2	1	0,03
		for 3 circuit-breakers	IP10	M4 32 S3	1	0,05
		for 4 circuit-breakers	IP10	M4 32 S4	1	0,07
		for 5 circuit-breakers	IP10	M4 32 S5	1	0,10
	Line side terminal 3-pole, connection from above	Conductor cross-section solid or stranded 6-25mm <sup>2</sup> with end sleeve 4-16mm <sup>2</sup>	IP10	M4 32 SE	1	0,04
	Cover for tags	Touch guard for empty spaces		M4 32 SF	1	0,003
	Cover for tags	Touch guard for empty spaces		M4 32 SFV	1	0,003

For feeding several modular circuit-breakers M4-63. on standard mounting rails, insulated  
Rated operational voltage max. 690 V, rated current 108 A, with **pin connection**, modular spacing 55mm

	3-phase busbars	for 2 circuit-breakers	IP20	M4 63 S2	1	0,15
--	-----------------	------------------------	------	----------	---	------

# Mounting Parts for Fuseless Load Feeders

	Type	Pack pcs.	Weight approx. kg/pc.
<b>DIN-rail adapters with DIN-rail for contactor</b>			
	for M4-32.. DIN-rails moveable for easy mounting and replacing can be connected on one 35 mm DIN-rail (high 15mm) or two 35 mm-DIN-rails (125mm distance) suitable for contactors K1-..., K(G)3-10 to K(G)3-40	M4 32 HU1	1 0,1
	Adapter, for M4-63.. can be connected on two 35 mm DIN-rails (125mm distance) or one 75 mm DIN-rail, or screw mounting suitable for contactors K(G)3-24 to K(G)3-40, K3-50 to K3-74	M4 63 HU1	1 0,2
	Adapter, for M4-100.. can be connected on two 35 mm DIN-rails (125mm distance) or one 75 mm DIN-rail, or screw mounting suitable for contactors K3-50 to K3-74	M4 100 HU1	1 0,2

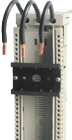
<b>Busbar adapters for 60-mm-system, 3 copper busbars acc. to DIN 46433</b>			
	for M4-32 up to 25A, 690V 45mm width, 182mm long bar width: 12 und 15mm bar thickness: 5 and 10mm	M4 32 SA60	1 0,18

<b>Link modules, for mechanical and electrical connection between circuit-breaker and contactor</b>				
	for M4-32.. with contactors K1-..	max. 32A	M4 32 VK1	1 0,015
	for M4-32.. with contactors K3-10 to K3-22	max. 32A	M4 32 VK3	1 0,02
	for M4-32.. with contactors KG3-10 to KG3-22	max. 32A	M4 32 VKG3	1 0,02

<b>Link modules, for electrical connection between circuit-breaker and contactor</b>				
	for M4-32. with contactors K3-24 to K3-40	max. 32A	M4 32 VD	1 0,01
	for M4-32. with contactors KG3-24 to KG3-40	max. 32A	M4 32 VDG	1 0,01
	for M4-63R. with contactors K3-24 to K3-40	max. 63A	M4 63 VD	1 0,02
	for M4-63R. with contactors KG3-24 to KG3-40	max. 63A	M4 63 VDG	1 0,02
	for M4-63R. with contactors K3-50 to K3-74	max. 63A	M4 63 VD50	1 0,02
	for M4-100R. with contactors K3-50 to K3-74	max. 100A	M4 100 VD	1 0,02

# Components for Fuseless Load Feeders, DIN-Rail Mounting

Type of coordination "1" 3x415V 10kA <sup>1)</sup>



Motor 3~400V kW	Setting range A	Circuit-breaker page 166 Type	Link module Type	Contactor <sup>2)</sup> 220-230V 50Hz Type	DIN-rail adapter Type
-	0,10 – 0,16	M4-32T-0,16	M4 32 VK1	K1-09D10 230	-
0,06	0,16 – 0,25	M4-32T-0,25	M4 32 VK1	K1-09D10 230	-
0,09	0,25 – 0,4	M4-32T-0,4	M4 32 VK1	K1-09D10 230	-
0,18	0,4 – 0,63	M4-32T-0,63	M4 32 VK1	K1-09D10 230	-
0,25	0,63 – 1	M4-32T-1	M4 32 VK1	K1-09D10 230	-
0,55	1,0 – 1,6	M4-32T-1,6	M4 32 VK1	K1-09D10 230	-
0,75	1,6 – 2,5	M4-32T-2,5	M4 32 VK1	K1-09D10 230	-
1,5	2,5 – 4	M4-32T-4	M4 32 VK1	K1-09D10 230	-
2,2	4 – 6	M4-32T-6	M4 32 VK1	K1-09D10 230	-
3	5 – 8	M4-32T-8	M4 32 VK1	K1-09D10 230	-
4	6 – 10	M4-32T-10	M4 32 VK1	K1-09D10 230	-
5,5	9 – 13	M4-32T-13	M4 32 VK1	K1-12D10 230	-
7,5	11 – 17	M4-32T-17	M4 32 VK3	K3-18ND10 230EUR	-
7,5	14 – 22	M4-32T-22	M4 32 VK3	K3-22ND10 230EUR	-
11	18 – 26	M4-32T-26	M4 32 VK3	K3-22ND10 230EUR	-
15	22 – 32	M4-32T-32	M4 32 VD	K3-32A00 230	M4 32 HU1
18,5	28 – 40	M4-32T-40	M4 32 VD	K3-40A00 230	M4 32 HU1
-	0,10 – 0,16	M4-32R-0,16	M4 32 VK3	K3-10ND10 230EUR	-
0,06	0,16 – 0,25	M4-32R-0,25	M4 32 VK3	K3-10ND10 230EUR	-
0,09	0,25 – 0,4	M4-32R-0,4	M4 32 VK3	K3-10ND10 230EUR	-
0,18	0,4 – 0,63	M4-32R-0,63	M4 32 VK3	K3-10ND10 230EUR	-
0,25	0,63 – 1	M4-32R-1	M4 32 VK3	K3-10ND10 230EUR	-
0,55	1,0 – 1,6	M4-32R-1,6	M4 32 VK3	K3-10ND10 230EUR	-
0,75	1,6 – 2,5	M4-32R-2,5	M4 32 VK3	K3-10ND10 230EUR	-
1,5	2,5 – 4	M4-32R-4	M4 32 VK3	K3-10ND10 230EUR	-
2,2	4 – 6	M4-32R-6	M4 32 VK3	K3-10ND10 230EUR	-
3	5 – 8	M4-32R-8	M4 32 VK3	K3-10ND10 230EUR	-
4	6 – 10	M4-32R-10	M4 32 VK3	K3-10ND10 230EUR	-
5,5	9 – 13	M4-32R-13	M4 32 VK3	K3-14ND10 230EUR	-
7,5	11 – 17	M4-32R-17	M4 32 VK3	K3-18ND10 230EUR	-
7,5	14 – 22	M4-32R-22	M4 32 VK3	K3-22ND10 230EUR	-
11	18 – 26	M4-32R-26	M4 32 VK3	K3-22ND10 230EUR	-
15	22 – 32	M4-32R-32	M4 32 VD	K3-32A00 230	M4 32 HU1
18,5	28 – 40	M4-32R-40	M4 32 VD	K3-40A00 230	M4 32 HU1
12,5	18 – 26	M4-63R-26	M4 63 VD	K3-32A00 230	M4 63 HU1
15	22 – 32	M4-63R-32	M4 63 VD	K3-32A00 230	M4 63 HU1
18,5	28 – 40	M4-63R-40	M4 63 VD	K3-40A00 230	M4 63 HU1
22	34 – 50	M4-63R-50	M4 63 VD50	K3-50A00 230	M4 63 HU1
30	45 – 63	M4-63R-63	M4 63 VD50	K3-62A00 230	M4 63 HU1
30	45 – 63	M4-100R-63	M4 100 VD	K3-62A00 230	M4 100 HU1
37	55 – 75	M4-100R-75	M4 100 VD	K3-74A00 230	M4 100 HU1
45	70 – 90	M4-100R-90	-	K3-90A00 230	-
-	80 – 100	M4-100R-100	-	K3-115A00 230	-

1) Other conditions on request

2) Contactors K1.. 220-230V 50Hz, Contactors K3.. 220-240V 50Hz, further technical data see Catalog D677..

# Technical Data according to IEC/EN 60947-1, 60947-2, 60947-4-1 and VDE 0660

This table shows the rated ultimate short-circuit breaking capacity  $I_{cu}$  and the rated service short-circuit breaking capacity  $I_{cs}$  of the M4 circuit-breakers with different operational voltages as a function of the rated current  $I_n$  of the circuit-breakers. The circuit-breakers can be fed at the top or bottom supply terminals without any reduction of the rated data.

If the short-circuit current exceeds the rated short-circuit breaking capacity of the circuit-breaker specified in the tables at the installation point, a back-up fuse is to be used. The maximum rated current for the back-up fuse is specified in the tables. These fuses are only suitable for the short-circuit-currents as indicated on the fuses.

Circuit-breaker	Rated-current $I_n$	up to AC 240V <sup>2)</sup>			up to AC 400V <sup>2)</sup> up to AC 415V <sup>3)</sup>			up to AC 440V <sup>2)</sup> up to AC 460V <sup>3)</sup>			up to AC 500V <sup>2)</sup> up to AC 525V <sup>3)</sup>			up to AC 690V <sup>2)</sup>		
		$I_{cu}$	$I_{cs}$	max. fuse <sup>1)</sup> (gL/gG)	$I_{cu}$	$I_{cs}$	max. fuse <sup>1)</sup> (gL/gG)	$I_{cu}$	$I_{cs}$	max. fuse <sup>1)</sup> (gL/gG)	$I_{cu}$	$I_{cs}$	max. fuse <sup>1)</sup> (gL/gG)	$I_{cu}$	$I_{cs}$	max. fuse <sup>1)</sup> (gL/gG)
Type	A	kA	kA	A	kA	kA	A	kA	kA	A	kA	kA	A	kA	kA	A
M4-32T	0,16 ... 0,63	100	100	--	100	100	--	100	100	--	100	100	--	100	100	--
	1	100	100	--	100	100	--	100	100	--	100	100	--	100	100	--
	1,6	100	100	--	100	100	--	100	100	--	100	100	--	3	3	20
	2,5	100	100	--	100	100	--	100	100	--	50	38	50	3	3	35
	4	100	100	--	100	100	--	50	38	50	15	11	40	3	3	40
	6	100	100	--	100	100	--	15	11	50	10	8	50	3	3	50
	8	100	100	--	100	100	--	15	11	63	10	8	63	3	3	63
	10	100	100	--	50	38	80	15	11	63	6	5	63	3	3	63
	13	100	100	--	50	38	80	10	8	80	6	5	80	3	3	63
	17	50	38	--	20	15	100	10	8	80	6	5	80	3	3	63
	22	40	30	125	15	11	100	8	6	100	6	5	80	3	3	63
	26	40	30	125	15	11	100	8	6	100	6	5	80	3	3	63
	32	30	22	125	15	11	100	6	4	100	5	4	80	3	3	63
	40	20	15	160	10	8	125	5	3	100	4	3	80	2	2	63
M4-32R	0,16 ... 1,0	100	100	--	100	100	--	100	100	--	100	100	--	100	100	--
	1,6	100	100	--	100	100	--	100	100	--	100	100	--	100	100	--
	2,5	100	100	--	100	100	--	100	100	--	100	100	--	8	8	35
	4	100	100	--	100	100	--	100	100	--	100	100	--	8	8	40
	6	100	100	--	100	100	--	100	100	--	100	100	--	6	6	50
	8	100	100	--	100	100	--	50	38	80	50	38	63	6	6	63
	10	100	100	--	100	100	--	50	38	80	50	38	80	6	6	63
	13	100	100	--	100	100	--	50	38	80	42	32	80	6	6	63
	17	100	100	--	50	38	100	25	15	80	10	8	80	4	4	63
	22	100	100	--	50	38	125	25	15	100	10	8	80	4	4	63
26	100	100	--	50	38	125	25	15	100	10	8	80	4	4	63	
32	100	100	--	50	38	125	25	15	100	10	8	80	4	4	63	
40	100	100	--	40	30	160	15	11	125	8	6	160	3	3	80	
M4-63R	26	100	100	--	50	50	125	35	27	125	12	9	100	5	5	80
	32	100	100	--	50	50	125	35	27	125	10	8	100	5	5	80
	40	100	100	--	50	50	160	35	27	125	10	8	100	5	5	80
	50	100	100	--	50	50	160	35	27	125	10	8	100	5	5	80
	63	100	100	--	50	50	160	35	27	160	10	8	100	5	5	80
M4-100R	63	100	100	--	50	38	160	40	30	160	12	9	100	6	5	80
	75	100	100	--	50	38	160	40	30	160	8	6	125	5	4	100
	90	100	100	--	50	38	160	40	30	160	8	6	125	5	4	125
	100	100	100	--	50	38	160	40	30	160	8	6	125	5	4	125

-- No back-up fuse required

1) Back up fuse required if short-circuit current at installation point  $I_{cc} > I_{cu}$



2) 10 % overvoltage

3) 5 % overvoltage

## Main Circuit

Type		M4-32T	M4-32R	M4-63R	M4-100R
<b>Number of poles</b>		3	3	3	3
<b>Max. rated current <math>I_{nmax}</math> (=max. rated operational current <math>I_n</math>)</b>	A	40	40	63	100
<b>Permissible ambient temperature</b>					
Storage/transport	°C	-50 to +80	-50 to +80	-50 to +80	-50 to +80
Operation	°C	-20 to +60	-20 to +60	-20 to +60	-20 to +60
Storage/transport	°F	-58 to +176	-58 to +176	-58 to +176	-58 to +176
Operation	°F	-4 to +140	-4 to +140	-4 to +140	-4 to +140
<b>Rated insulation voltage <math>U_i</math></b>	V	690 <sup>1)</sup>	690 <sup>1)</sup>	1000 <sup>2)</sup>	1000 <sup>2)</sup>
<b>Rated impulse withstand voltage <math>U_{imp}</math></b>	kV	6	6	8	8
<b>Rated operational voltage <math>U_e</math></b>	V	690	690	690	690
<b>Rated frequency</b>	Hz	50/60	50/60	50/60	50/60
<b>Utilization category</b>					
IEC 60947-2 (circuit-breaker)		A	A	A	A
IEC 60947-4-1 (motor starter)		AC3	AC3	AC3	AC3
<b>Class</b>	acc. to IEC 60947-4-1	10	10	10	10
<b>Power loss <math>P_v</math> per circuit-breaker dependent on rated current <math>I_n</math> (upper setting range)</b>	$I_n \rightarrow 0,16$ up to 1,6 A $I_n \rightarrow 2,5$ up to 26 A $I_n \rightarrow 32$ A	W W W	4,4 7,4 4	4,4 7,4 -	- - -
<b>R per conducting path = <math>P/I^2 \times 3</math></b>	$I_n \rightarrow 26$ up to 63 A $I_n \rightarrow$ up to 63 A $I_n \rightarrow 75$ up to 100 A	W W W	- - -	- - -	- 21,8 17,8
<b>Shock resistance</b>	acc. to IEC 60068 Part 2-27	g	25	25	25
<b>Degree of protection</b>	acc. to IEC 60529		IP 20	IP 20	IP 20
<b>Shock hazard protection</b>	acc. to DIN VDE 0106 Part 100		safe against finger touch	safe against finger touch	safe against finger touch
<b>Temperature compensation</b>	acc. to IEC 60947-4-1	°C	-20 to +60	-20 to +60	-20 to +60
<b>Mechanical endurance</b>	operating cycles		100 000	100 000	50 000
<b>Electrical endurance</b>			100 000	100 000	25 000
<b>Max. operating frequency per hour (motor starts)</b>	1/h		25	25	25

## Approvals

Country Type	 USA, Canada UL	 Switzerland SEV	 Europe CE	CB/CCA-Certificates
M4-32T	o	o	/	o
M4-32R	o	o	/	o
M4-63R	o	o	/	o
M4-100R	o	o	/	o
M4 H..	o	-	/	-
M4 M..	o	-	/	-
M4 U..	o	-	/	-
M4 A..	o	-	/	-





o In standard version approved / No testing required CE x In test  
 - Not provided for test till now

1) Suitable at 690V for: earthed-neutral systems, overvoltage category I to IV, pollution degree 3 (standard-industry):  $U_{imp} = 6kV$ .

2) Suitable at 1000V for: earthed-neutral systems, overvoltage category I to IV, pollution degree 3 (standard-industry):  $U_{imp} = 8kV$ .

3) Data for other conditions on request.

Conductor cross-sections for main circuit

Type	Terminal type, screw type	Tightening torque		Conductor, cross-sections solid		Conductor, cross-sections stranded		Conductor, cross-sections flexible	
		Nm	lb - in	mm <sup>2</sup>	AWG	mm <sup>2</sup>	AWG	mm <sup>2</sup>	AWG
M4-32T 	Pz2	0,8 - 2,5	7 - 22	1 x (1 - 10) 2 x (1 - 6)	1 x (18 - 8) 2 x (18 - 10)	1 x (1 - 6) 2 x (1 - 6)	1 x (18 - 10) 2 x (18 - 10)	1 x (1 - 6) 2 x (0,75 - 4)	1 x (18 - 10) 2 x (18 - 10)
M4-32R 	Pz2	0,8 - 2,5	7 - 22	1 x (1 - 10) 2 x (1 - 6)	1 x (18 - 8) 2 x (18 - 10)	1 x (1 - 6) 2 x (1 - 6)	1 x (18 - 10) 2 x (18 - 10)	1 x (1 - 6) 2 x (0,75 - 4)	1 x (18 - 10) 2 x (18 - 10)
M4-63R 	Pz2	3 - 4,5	26 - 39	1 x (0,75 - 35) 2 x (0,75 - 25)	1 x (18 - 2) 2 x (18 - 4)	1 x (0,75 - 35) 2 x (0,75 - 25)	1 x (18 - 2) 2 x (18 - 4)	1 x (0,75 - 25) 2 x (0,75 - 16)	1 x (18 - 4) 2 x (18 - 6)
M4-100R 	4mm hexagon socket screw	4 - 6	35 - 53	1 x (2,5 - 70) 2 x (2,5 - 50)	1 x (12 - 2/0) 2 x (12 - 1/0)	1 x (2,5 - 70) 2 x (2,5 - 50)	1 x (12 - 2/0) 2 x (12 - 1/0)	1 x (2,5 - 50) 2 x (2,5 - 35)	1 x (12 - 1/0) 2 x (10 - 2)

Auxiliary switches

Type	Rated operational voltage		Rated operational current		Rated operational voltage		Rated operational current	
	U <sub>e</sub>		I <sub>e</sub> /AC-15		U <sub>e</sub>		I <sub>e</sub> /DC-13	
	AC				DC L/R 200 ms			
Type	V	A	A	A	V	A	A	A
Front transverse auxiliary switch	M4 HQ..	24 240	3 3	5 5	24 220	1 0,1		
Lateral auxiliary switch and signalling switch	M4 HS..							
	M4 M..	24 240	6 4	10 10	24 220	2 0,25		

Type	Power consumption during pick-up		Response voltage trip	Response voltage acc. to IEC 60947-1
	VA/W	V		
Undervoltage release	M4 U..	8,5/6	3/1,2	0,7 - 0,35xUs 0,85 - 1,1xUs
Shunt release	M4 A..	8,5/6	3/1,2	0,7 - 1,1xUs

Type	Fuse	Miniature circuit breaker	solid	flexible	AWG-wires, solid	flexible
	gL/gG	C-characteristic	mm <sup>2</sup>	mm <sup>2</sup>	AWG	AWG
Short-circuit protection for auxiliary and control circuits	16	6				
Conductor cross-sections for auxiliary and control circuits			1 x (0,5 - 2,5) 2 x (0,5 - 2,5) <sup>1)</sup>	1 x (0,5 - 4) 2 x (0,75 - 2,5)	1 x (20 - 14) 2 x (20 - 14) <sup>1)</sup>	1 x (20 - 10) 2 x (18 - 14)

Type	Tightening torque	
	Nm	lb - in
Auxiliary switches M4 HQ.., M4 HS.., M4 M.., M4 U.., M4 A..	0,8 - 1,2	7 - 10

1) M4 HQ.. 1 solid conductor only

## Permissible ratings of devices approved for North America

### Circuit breakers M4 as „Manual Motor Starter“

If used as „Manual Motor Starter“ the circuit breaker is always operated in combination with a short circuit device. For use with approbated fuses or circuit breakers according to UL489 or CSA22.2 No. 5 only. The sizes are selected according to National Electrical Code (UL), or Canadian Electrical Code (CSA).

Typ	Rated operational current le A	Max. short-circuit current			Motor load 1-phase		Motor load 3-phase				Max. rated fuse A	Max. breaker size A
		240V kA	480V kA	600V kA	115V HP	230V HP	200V HP	230V HP	460V HP	600V HP		
<b>M4-32T</b>	0,16 ... 0,63	100	50	10	-	-	-	-	-	-	1	15
	1	100	50	10	-	-	-	-	-	1/2	3	15
	1,6	100	50	10	-	1/10	-	-	3/4	3/4	6	15
	2,5	100	50	10	-	1/6	1/2	1/2	1	1 1/2	10	15
	4	100	50	5	1/8	1/3	3/4	3/4	2	3	15	15
	6	100	25	5	1/4	1/2	1	1 1/2	3	5	20	20
	8	100	25	5	1/3	1	2	2	5	5	30	30
	10	50	10	5	1/2	1 1/2	2	3	5	7 1/2	40	40
	13	50	10	5	1/2	2	3	3	7 1/2	10	50	50
	17	40	10	5	1	3	3	5	10	15	60	60
	22	30	10	5	1 1/2	3	5	7 1/2	15	20	80	80
	26	30	7,5	5	2	3	7 1/2	7 1/2	15	20	100	100
	32	20	7,5	5	2	5	7 1/2	10	20	30	125	125
	40	20	7,5	5	3	7 1/2	10	10	30	30	150	150
<b>M4-32R</b>	0,16 ... 0,63	100	50	10	-	-	-	-	-	-	1	15
	4	100	50	10	1/8	1/3	3/4	3/4	2	3	15	15
	6	100	50	10	1/4	1/2	1	1 1/2	3	5	20	20
	8	100	50	10	1/3	1	2	2	5	5	30	30
	10	100	50	10	1/2	1 1/2	2	3	5	7 1/2	40	40
	13	100	50	10	1/2	2	3	3	7 1/2	10	50	50
	17	100	30	10	1	3	3	5	10	15	60	60
	22	100	30	10	1 1/2	3	5	7 1/2	15	20	80	80
	26	100	30	10	2	3	7 1/2	7 1/2	15	20	100	100
	32	100	30	10	2	5	7 1/2	10	20	30	125	125
	40	100	30	10	3	7 1/2	10	10	30	30	150	150
<b>M4-63R</b>		100	50	10	2	3	7 1/2	7 1/2	15	20	100	100
	32	100	50	10	2	5	7 1/2	10	20	30	125	125
	40	100	50	10	3	7 1/2	10	10	30	30	150	150
	50	100	50	10	5	10	15	15	30	40	200	200
	63	100	50	10	5	10	20	20	40	60	250	250
<b>M4-100R</b>	63	100	25	10	5	10	20	20	40	60	250	250
	75	100	25	10	5	15	20	25	50	60	300	300
	90	100	25	10	7 1/2	20	25	30	60	75	350	350
	100	100	25	10	10	20	30	30	75	100	400	400

## Permissible ratings of devices approved for North America

Circuit breakers M4 as „Combination Motor Controller Type E“ and "Suitable for Group Installation"

Acc to UL 508 demands a line-side 1 inch air and 2 inch creepage distance for „Combination Motor Controller Type E“ is necessary. Therefore circuit-breaker M4-32R is approved to UL 508 in combination with the Terminal block M4 32R E. Circuit-breakers M4-100 are approved to UL 508 in combination with the insulation barriers M4 100 E. According to CSA these terminal blocks can be omitted when the device is used as „Combination Motor Controller Type E“.

Type	Rated operational current I <sub>e</sub> A	Max. short-circuit current			Motor load 1-phase		Motor load 3-phase				Max. rated fuse A	Max. breaker A
		240V kA	480V kA	600V kA	115V HP	230V HP	200V HP	230V HP	460V HP	600V HP		
<b>M4-32R</b>	0,16 ... 0,63	100	65	25	-	-	-	-	-	-	500	500
(+M4 32R E)	1	100	65	25	-	-	-	-	-	1/2	500	500
	1,6	100	65	25	-	1/10	-	-	3/4	3/4	500	500
	2,5	100	65	25	-	1/6	1/2	1/2	1	1 1/2	500	500
	4	100	65	25	1/8	1/3	3/4	3/4	2	3	500	500
	6	100	65	25	1/4	1/2	1	1 1/2	3	5	500	500
	8	100	65	25	1/3	1	2	2	5	5	500	500
	10	100	65	25	1/2	1 1/2	2	3	5	7 1/2	500	500
	13	100	65	25	1/2	2	3	3	7 1/2	10	500	500
	17	100	30	10	1	3	3	5	10	15	500	500
	22	100	30	10	1 1/2	3	5	7 1/2	15	20	500	500
	26	100	30	10	2	5	7 1/2	7 1/2	15	20	500	500
	32	100	30	10	2	5	7 1/2	10	20	30	500	500
	40	100	30	10	3	7 1/2	10	10	30	30	500	500
<b>M4-63R</b>	26	100	50	10	2	3	7 1/2	7 1/2	15	20	600	600
	32	100	50	10	2	5	7 1/2	10	20	30	600	600
	40	100	50	10	3	7 1/2	10	10	30	30	600	600
	50	100	50	10	5	10	15	15	30	40	600	600
	63	100	50	10	5	10	20	20	40	60	600	600
<b>M4-100R</b>	63	100	40	10	5	10	20	20	40	60	1000	1000
(+M4 100 E)	75	100	40	10	5	15	20	25	50	60	1000	1000
	90	100	40	10	7 1/2	20	25	30	60	75	1000	1000
	100	100	40	10	10	20	30	30	75	100	1000	1000

## Ratings of auxiliary switches and alarm switches

	Breaking capacity		Rated operational voltage max. V AC	Rated operational current A
	AC	DC		
Lateral auxiliary <b>M4 HS..</b> and signalling switch <b>M4 M..</b>	A600	Q300	600	10
Transversal auxiliary switch <b>M4 HQ..</b>	A300	R300	240	5

# Description

## Releases

Circuit-breakers M4 are equipped with bimetallic-based, inverse-time delayed overload releases and with instantaneous overcurrent releases (electromagnetic short-circuit releases). The overload releases can be set in accordance with the load current. The overcurrent releases are permanently set to a value 13 times the rated current and thus enable trouble-free start-up of motors. The scale cover can be sealed to prevent unauthorized adjustments to the set current.

## Operating mechanisms

Circuit-breakers M4-32T are actuated via a rocker operating mechanism and circuit-breakers M4-32R, M4-63R and M4-100R via a rotary operating mechanism. An electrical signal can be output, at all Circuit-breakers, via a signalling switch to indicate that the Circuit-breaker has tripped. All operating mechanisms can be locked in the 0 position with a padlock (shackle diameter 3.5 to 4.5 mm). The M4 Circuit-breakers fulfil the isolation characteristics specified in IEC 60947-2.

## Operating conditions

Circuit-breakers M4 are suitable for use in any climate. To avoid error tripping we recommend to protect the Circuit Breakers M4 against fresh and cold air (caused by air condition etc.) They are designed for operation in enclosed rooms under normal conditions (e. g. no dust, corrosive vapours or harmful gases). Suitable enclosures must be provided for installation in dusty or damp rooms. Circuit-breakers M4 can also be fed from below. In order to prevent premature tripping due to phase failure sensitivity, the three conducting paths must always be uniformly loaded. The conducting paths must be connected in series in the case of single-phase loads.

## Short-circuit protection

The short-circuit releases of M4 circuit-breakers disconnect the faulty load feeder from the system in the event of a short circuit and thus prevent any further damage from being caused. Circuit-breakers with a short-circuit breaking capacity of 50 kA or 100 kA at a voltage of 400 V AC are practically short-circuit-proof at this voltage, as higher short-circuit currents are not usually encountered at the installation point. Back-up fuses are only necessary if the short-circuit current at the installation point exceeds the rated ultimate short-circuit breaking capacity of the circuit-breakers.

## Motor protection

The tripping characteristics of M4 circuit-breakers are designed mainly to protect three-phase induction motors. The circuit-breakers are therefore also referred to as Manual Motor Starters. The current of the motor to be protected is set with the aid of the scale.

## Line protection

M4 Circuit-breakers for motor protection are also suitable for line protection. The M4 Circuit-breakers fulfil the isolation conditions of IEC 60 947-3 as well as the additional test conditions for circuit-breakers with isolation characteristics specified in IEC 60947-2. Taking IEC 60 204-1 into consideration, they can thus be implemented as main and EMERGENCY STOP switches. Door-coupling rotary operating mechanism do not fulfil the isolation characteristics.

# Tripping-Characteristics

M4-32

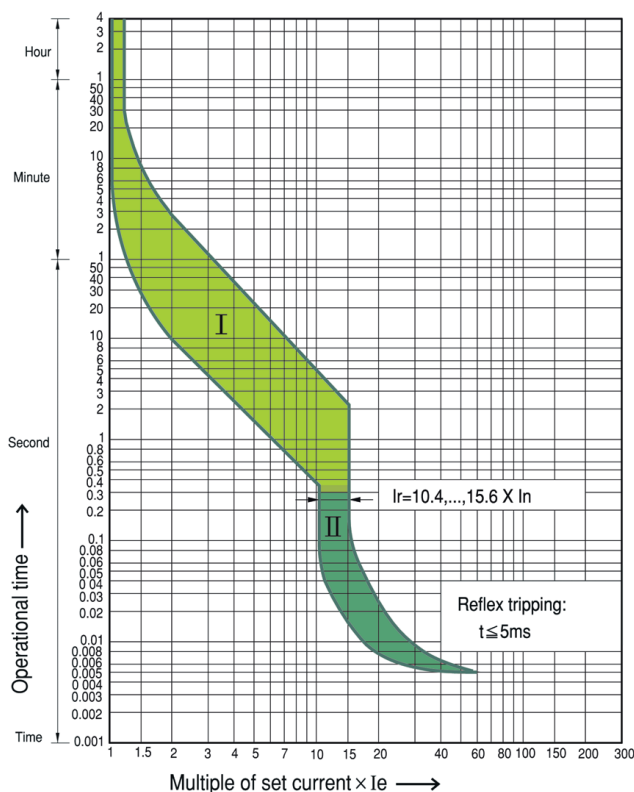

M4-63R, M4-100R

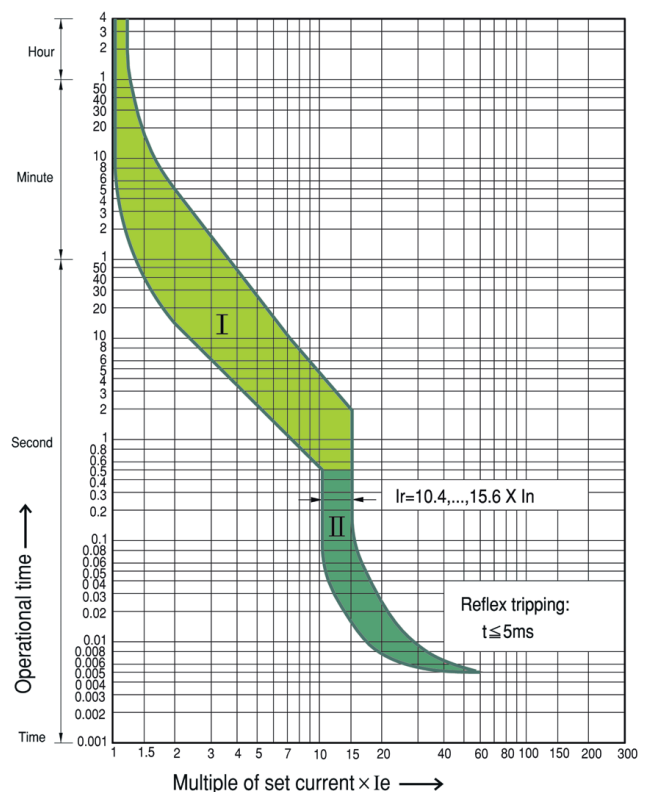

- I The curve shows the mean operating current at an ambient temperature of 20°C starting from cold.
- II The tripping characteristic of electromagnetic overcurrent releases (short-circuit releases)

The tripping characteristic of the inverse-time delayed overload releases apply for DC and AC with a frequency of 0 to 400 Hz. At operating temperature, the tripping times of the thermal releases are reduced to approximately 25 %.

The characteristic shown here is a schematic representation of circuit-breakers for all ranges. Current limiting characteristics and I<sup>2</sup>t characteristics are available on request.

Let-through Energy ( $I^2t$  /  $\text{kA}^2\text{s}$ ) and Peak Current ( $I_p$  /  $\text{kA}$ ) at  $U_e=415\text{V}$

M4-32R

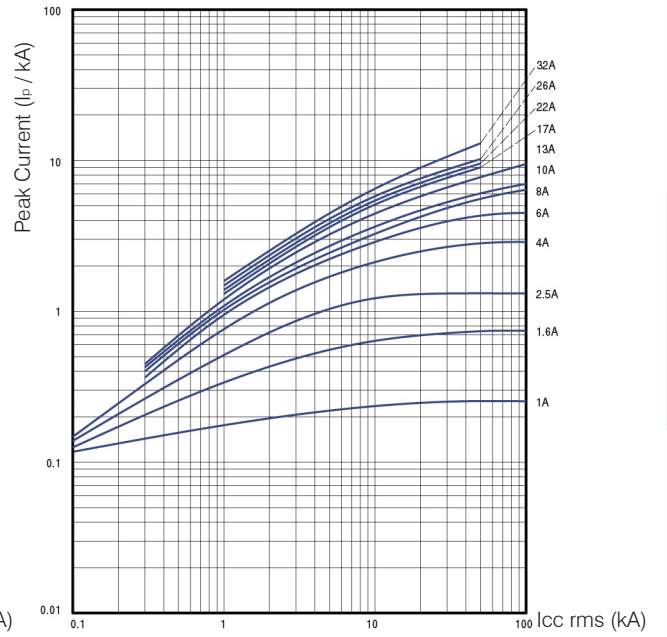
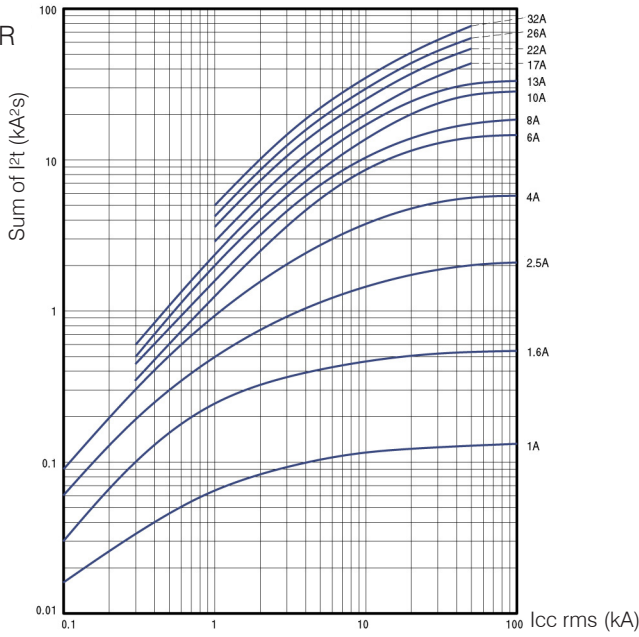

M4-63R

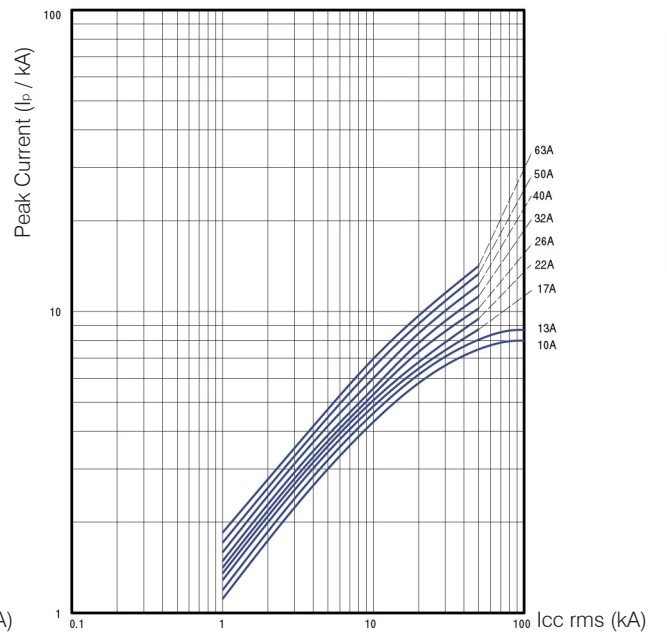
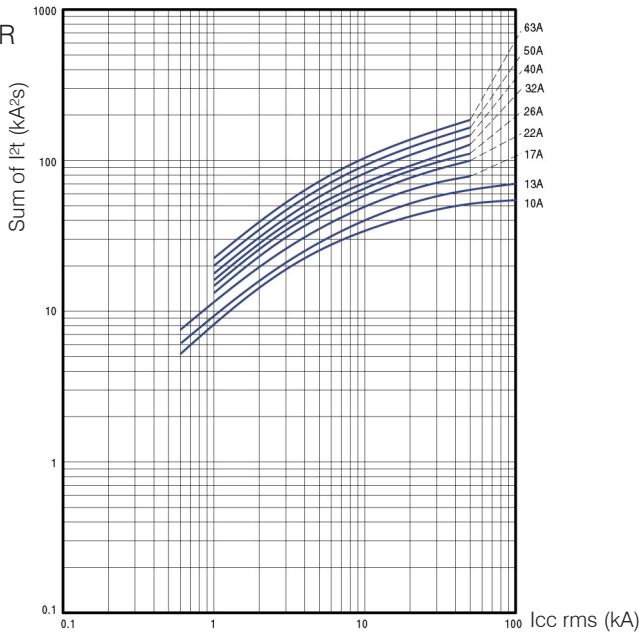

M4-100R

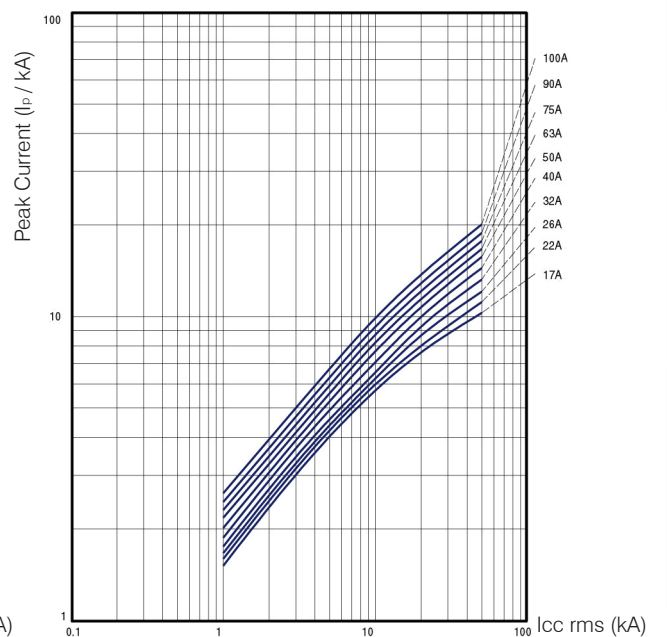
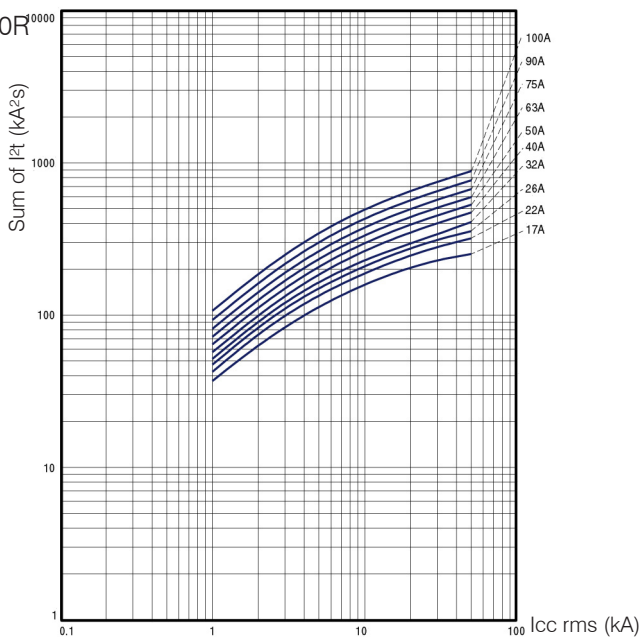

# Circuit Breakers M4 for Motor Control



## Technical Information IE3-Motor

Rated Current In A	Instantaneous Short Circuit Release A	Setting range Thermal Overload Release A		Instantaneous Short Circuit Release Ratio A	
		Min	Max	Min	Max
<b>Circuit Breakers M4-32T-..., M4-32R-..</b>					
0,16	2,1	0,1	0,16	21	13
0,25	3,3	0,16	0,25	20	13
0,4	5,2	0,25	0,4	21	13
0,63	8,2	0,4	0,63	21	13
1	13	0,63	1	21	13
1,6	20,8	1	1,6	21	13
2,5	32,5	1,6	2,5	20	13
4	52	2,5	4	21	13
6	78	4	6	20	13
8	104	5	8	21	13
10	130	6	10	22	13
13	169	9	13	19	13
17	221	11	17	20	13
22	286	14	22	20	13
26	338	18	26	19	13
32	416	22	32	19	13
40	520	28	40	19	13



<b>Circuit Breakers M4-63R-..</b>					
10	130	6	10	22	13
13	169	9	13	19	13
17	221	11	17	20	13
22	286	14	22	20	13
26	338	18	26	19	13
32	416	22	32	19	13
40	520	28	40	19	13
50	650	34	50	19	13
63	819	45	63	18	13
65	845	47	65	18	13



<b>Circuit Breakers M4-100R-..</b>					
17	221	11	17	20	13
22	286	14	22	20	13
26	338	18	26	19	13
32	416	22	32	19	13
40	520	28	40	19	13
50	650	34	50	19	13
63	819	45	63	18	13
75	975	55	75	18	13
90	1170	70	90	17	13
100	1300	80	100	16	13



- What is the IE3?

Motor is rated from IE1 through IE4 depends on its energy efficiency which means IE3 is more efficient compared to IE1 and IE2-rated motors.

IEC 60034-30 standard specifies IE classes for motors in accordance with the above requirements. Therefore, consumers must comply with the standard when using Circuit Breaker products.

- IE1 Standard Efficiency
- IE2 High Efficiency
- **IE3 Premium Efficiency**
- IE4 Super Premium Efficiency Was bedeutet IE3?

Pay attention that the ratio between inrush current and rated current of the motor is smaller than the instantaneous short circuit release ratio of the Circuit Breaker for Motor Control.

# Mounting

## DIN-rail mounting

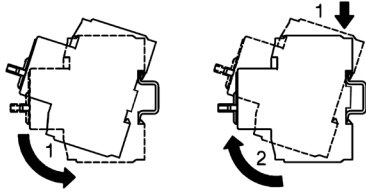

## Operating positions

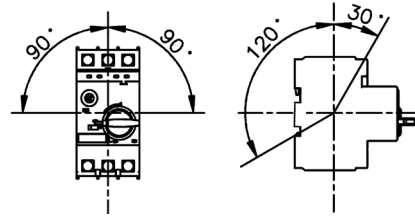

## Current setting (dont rotate the dial out of the shown range)

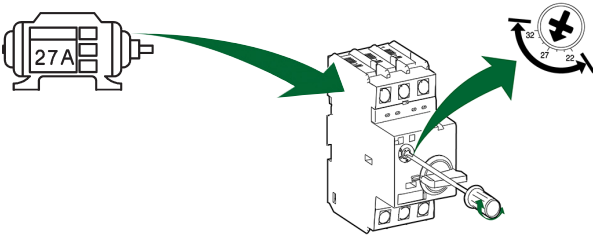

## Connection of 1-phase motor



# Wiring diagrams

## Circuit breaker

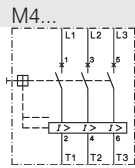

## Traverse Aux. Contact Block

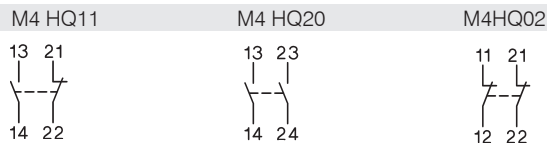

## Aux. Contact Block (side mounted)

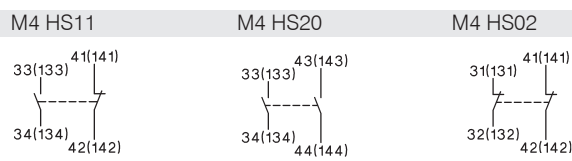

## Alarm Switch

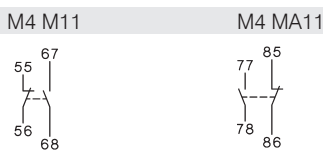

## Undervoltage Release

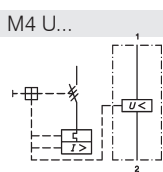

## Shunt Release

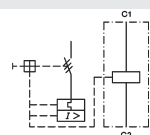

# Installation of accessories

M4-32T  
M4-32R

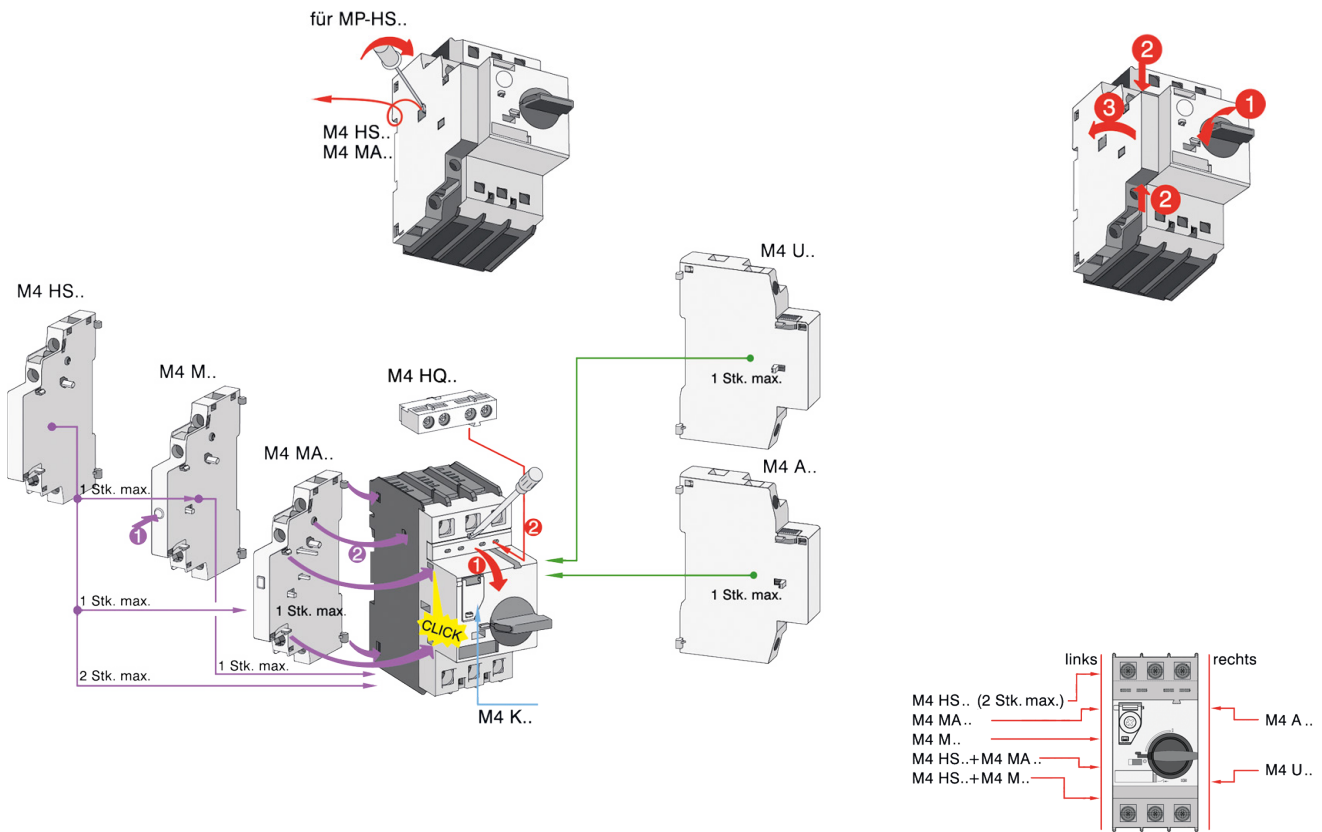

M4-63R  
M4-100R

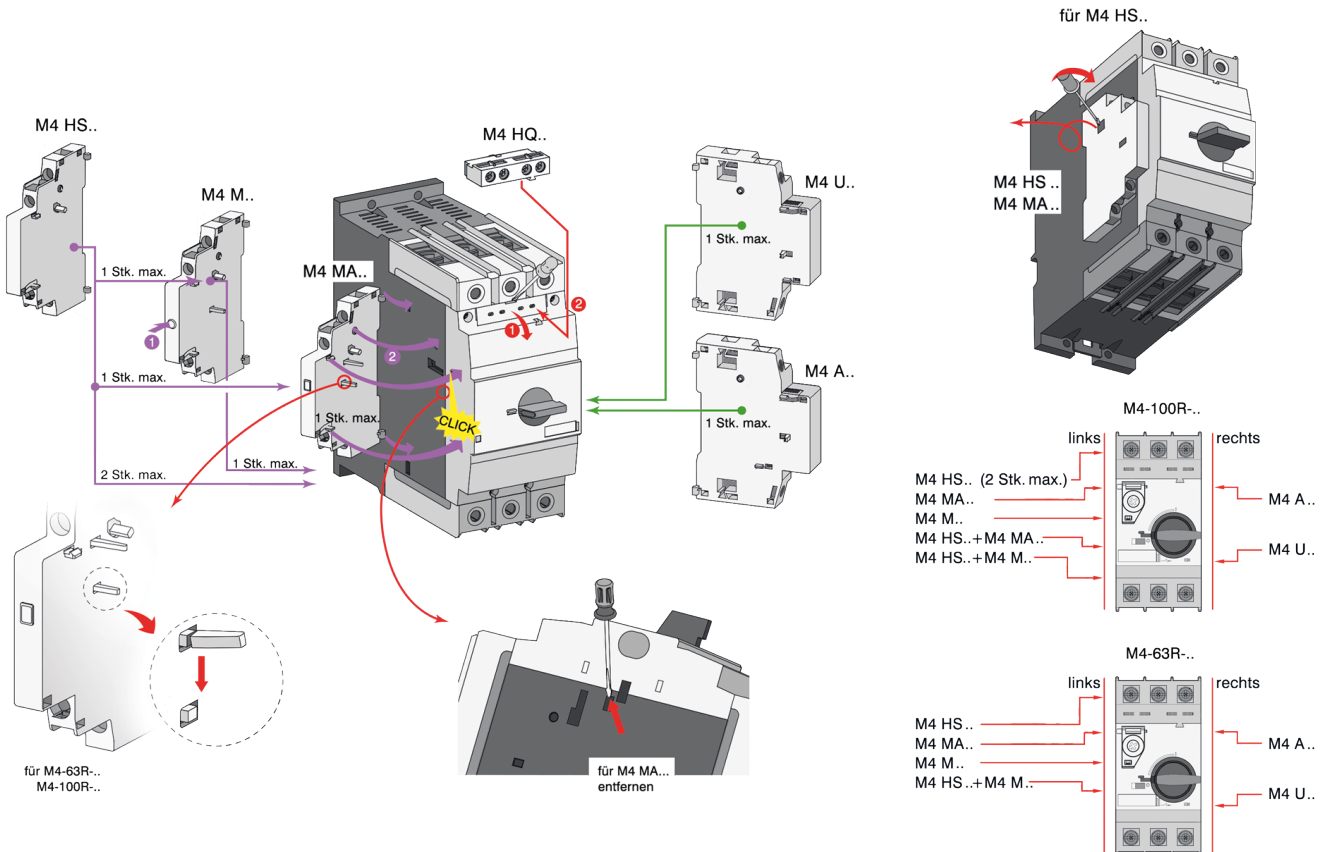

# Dimensions

## Circuit-breaker M4-32T

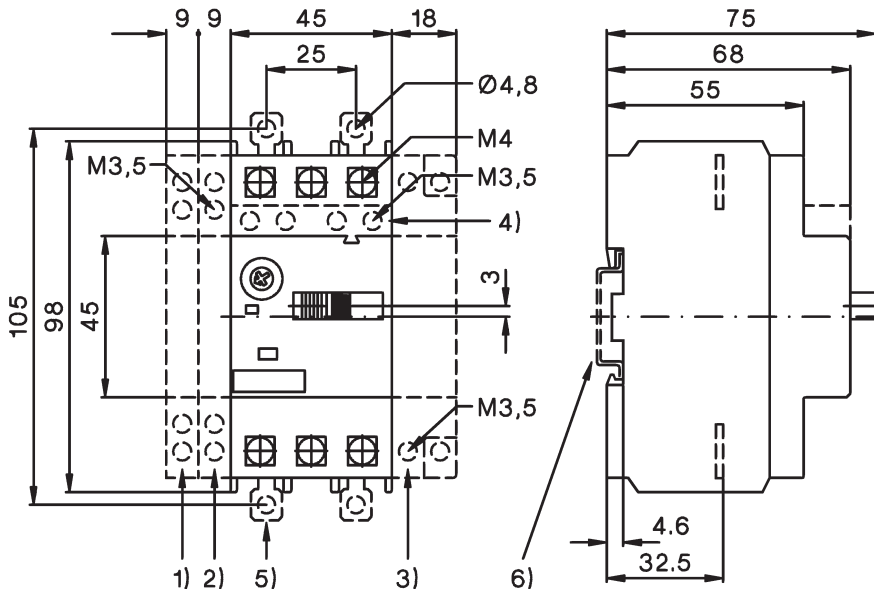

- 1) Side aux. contact
- 2) Magnetic trip alarm
- 3) Shunt or undervoltage release of arcing
- 4) Transverse aux. contact
- 5) Push-in Lugs for screw mounting
- 6) 35mm DIN-rail acc. to EN 50022

Height of arcing spaces (clearance from earthed parts )

at Ue (V)	240	415	460	525	690
mm	20	20	20	20	20
inch	0,8	0,8	0,8	0,8	0,8

## Circuit-breaker M4-32R

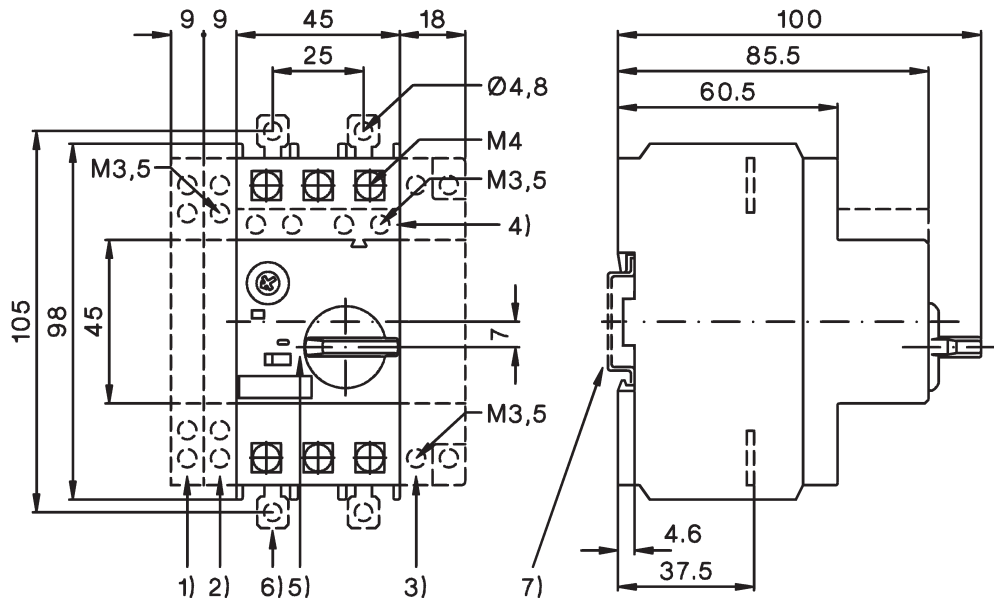

- 1) Side aux. contact
- 2) Magnetic trip alarm
- 3) Shunt or undervoltage release of arcing
- 4) Transverse aux. contact
- 5) Handle lock in OFF-position (Ø 5mm)
- 6) Push-in Lugs for screw mounting
- 7) 35mm DIN-rail acc. to EN 50022

Height of arcing spaces (clearance from earthed parts )

at Ue (V)	240	415	460	525	690
mm	30	30	30	30	50
inch	1,18	1,18	1,18	1,18	2

## Dimensions

### Circuit-breaker M4-63R

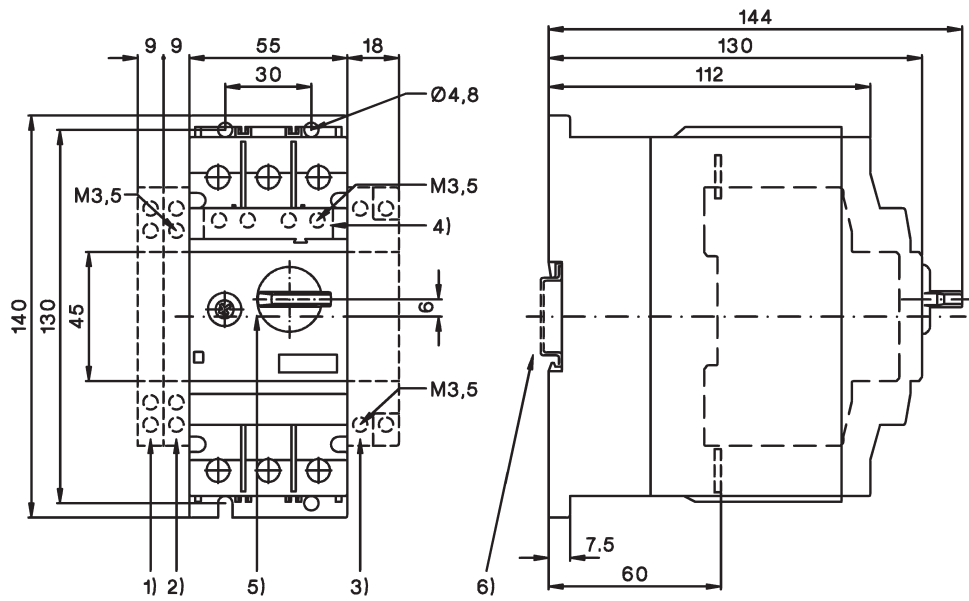

Height of arcing spaces (clearance from earthed parts )

at U <sub>e</sub> (V)	240	415	460	525	690
mm	50	50	50	50	50
inch	2	2	2	2	2

- 1) Side aux. contact
- 2) Magnetic trip alarm
- 3) Shunt or undervoltage release
- 4) Transverse aux. contact
- 5) Handle lock in OFF-position (Ø 5mm)
- 6) 35mm DIN-rail acc. to EN 50022

### Circuit-breaker M4-100R

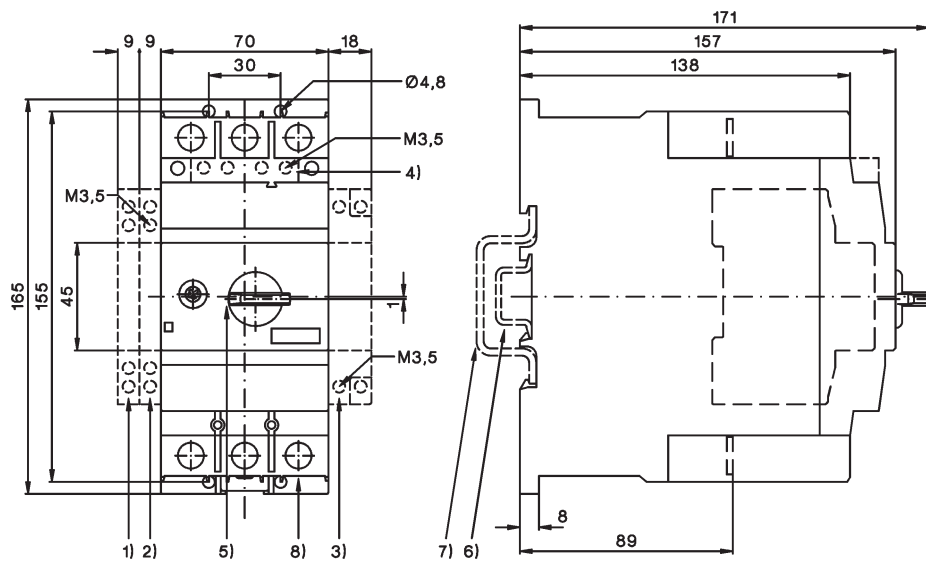

Height of arcing spaces (clearance from earthed parts )

at U <sub>e</sub> (V)	240	415	460	525	690
mm	50	70	70	110	150
inch	2	2¾	2¾	4,33	6

- 1) Side aux. contact
- 2) Magnetic trip alarm
- 3) Shunt or undervoltage release
- 4) Transverse aux. contact
- 5) Handle lock in OFF-position (Ø 5mm)
- 6) 35mm DIN-rail acc. to EN 50022
- 7) 70mm DIN-rail acc. to EN 50023
- 8) 4mm hexagon socket screw

# Dimensions

## Link Module M4 32 VK1

M4-32T + K1- . .

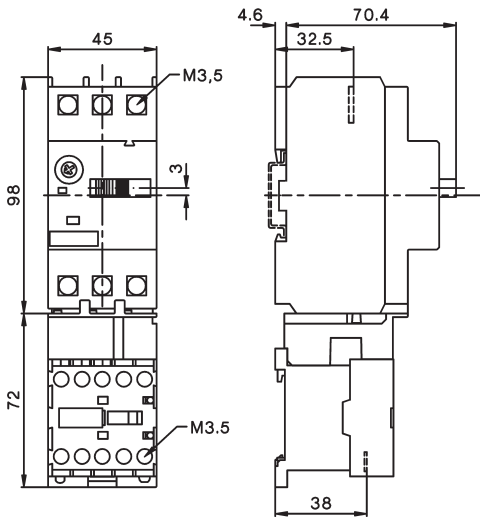

M4-32R + K1- . .

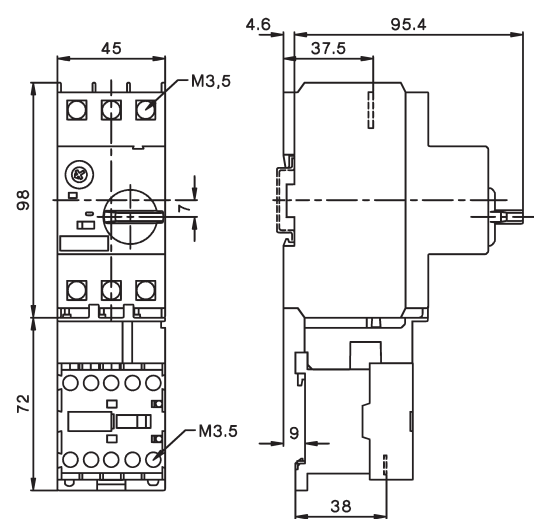

## Link Module M4 32 VK3

M4-32T + K3-10ND. .  
M4-32T + K3-18ND. .

M4-32T + K3-14ND. .  
M4-32T + K3-22ND. .

M4-32R + K3-10ND. .  
M4-32R + K3-18ND. .

M4-32R + K3-14ND. .  
M4-32R + K3-22ND. .

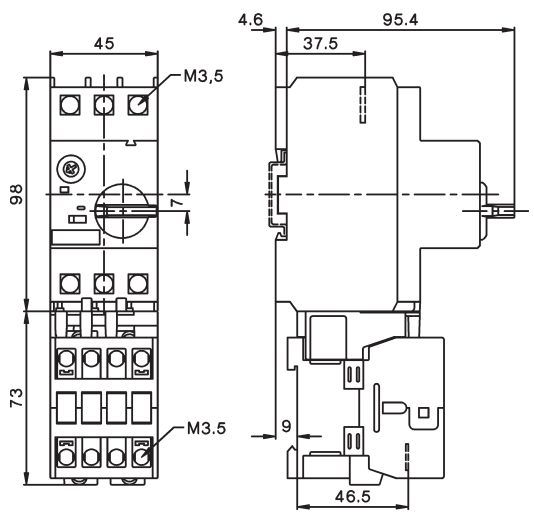
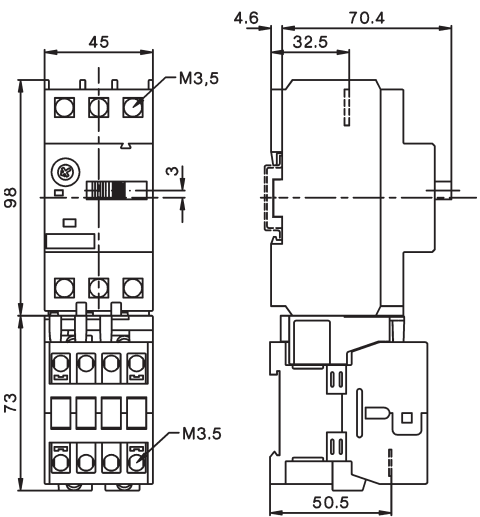

## Link Module M4 32 VKG3

M4-32T + KG3-10. .  
M4-32T + KG3-18. .

M4-32T + KG3-14. .  
M4-32T + KG3-22. .

M4-32R + KG3-10. .  
M4-32R + KG3-18. .

M4-32R + KG3-14. .  
M4-32R + KG3-22. .

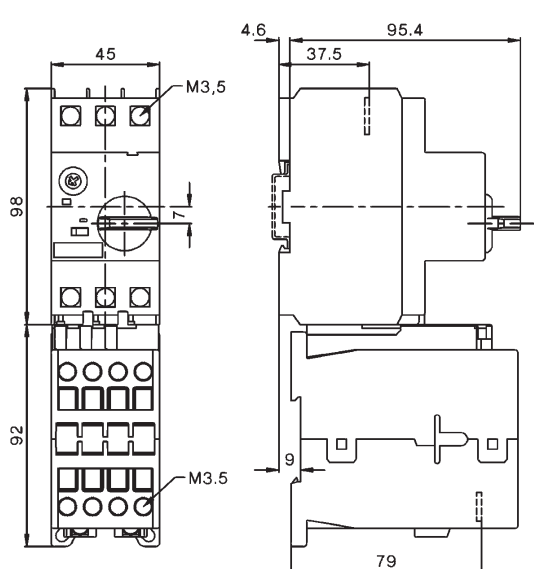
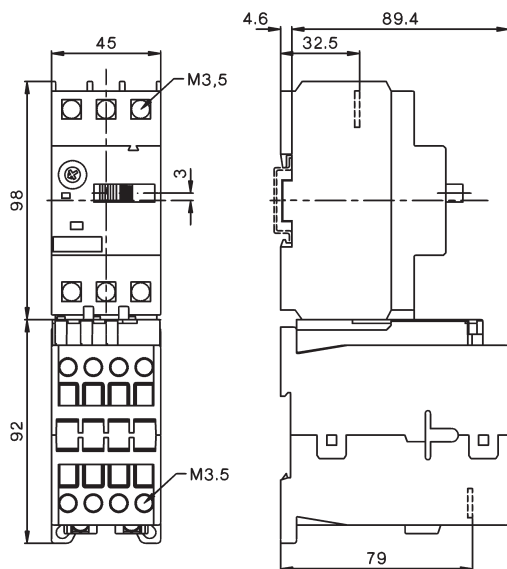

# Dimensions

## DIN-rail adapter M4 32 HU1

M4-32T + K3-24 + M4 32 VD  
 M4-32T + K3-32 + M4 32 VD

M4-32R + K3-24 + M4 32 VD  
 M4-32R + K3-32 + M4 32 VD

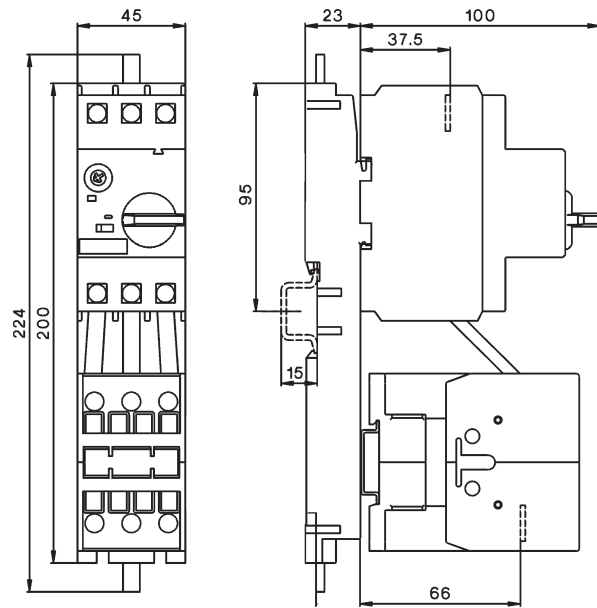
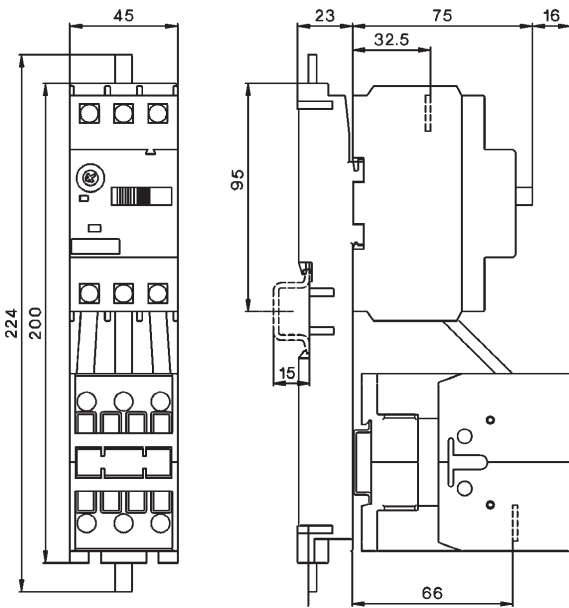

## DIN-rail adapter M4 32 HU1

M4-32T + KG3-24 + M4 32 VDG  
 M4-32T + KG3-32 + M4 32 VDG

M4-32R + KG3-24 + M4 32 VDG  
 M4-32R + KG3-32 + M4 32 VDG

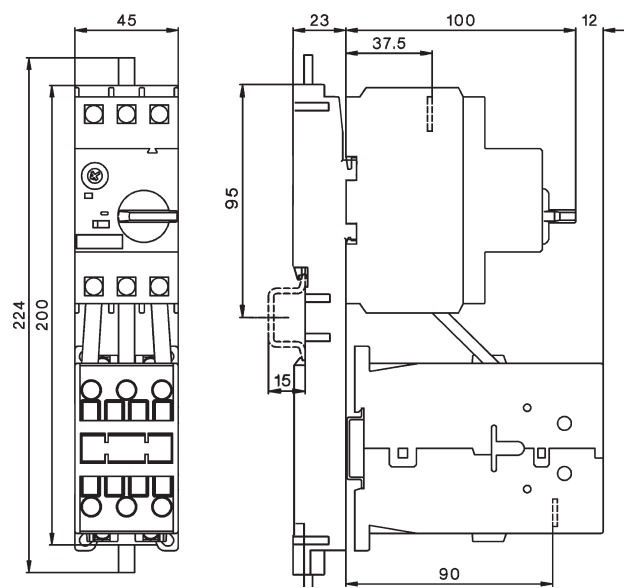
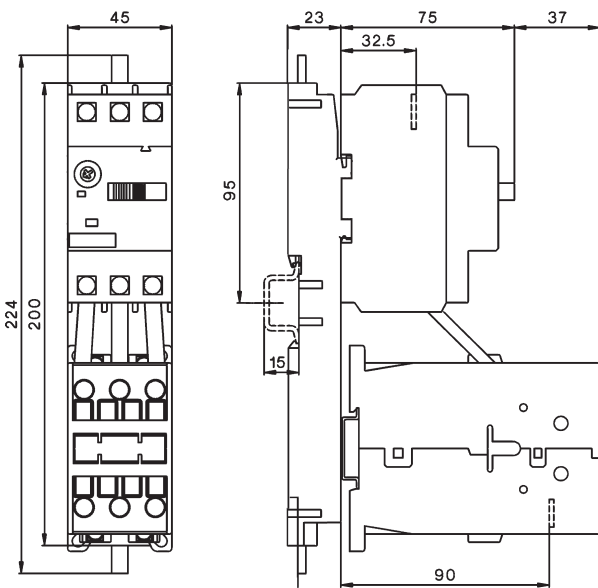

# Dimensions

## DIN-rail adapter M4 63 HU1

M4-63R + K3-32 + M4 63 VD  
 M4-63R + K3-40 + M4 63 VD

M4-63R + KG3-32 + M4 63 VDG  
 M4-63R + KG3-40 + M4 63 VDG

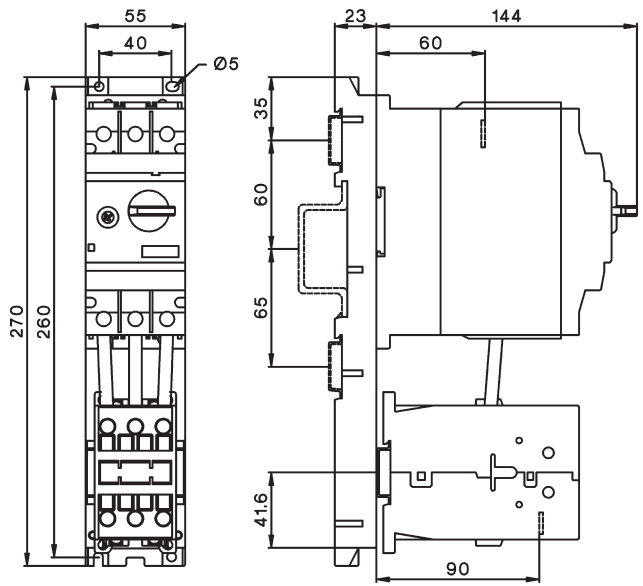
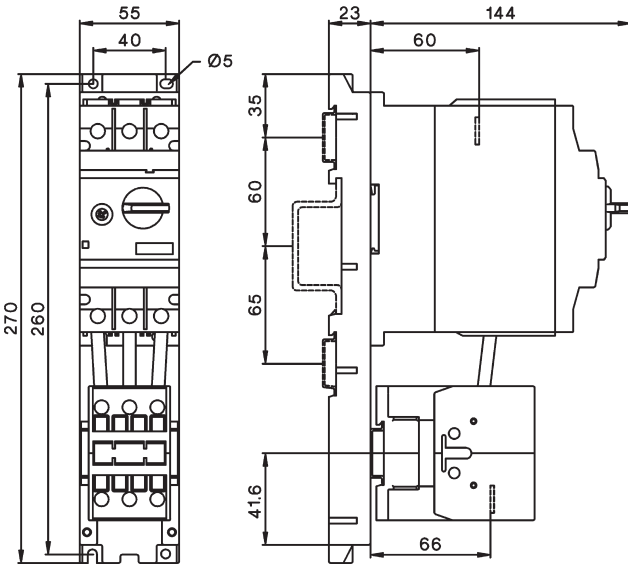

## DIN-rail adapter M4 63 HU1

M4-63R + K3-50 + M4 63 VD50  
 M4-63R + K3-62 + M4 63 VD50

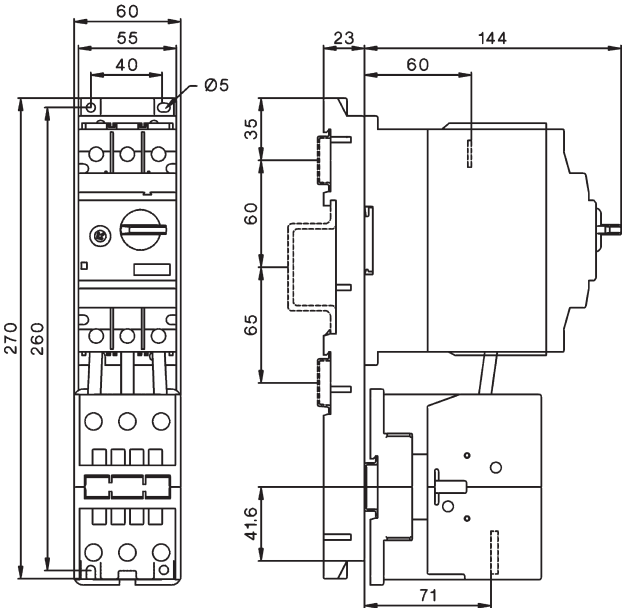

## DIN-rail adapter M4 100 HU1

M4-100R + K3-62 + M4 100 VD  
 M4-100R + K3-74 + M4 100 VD

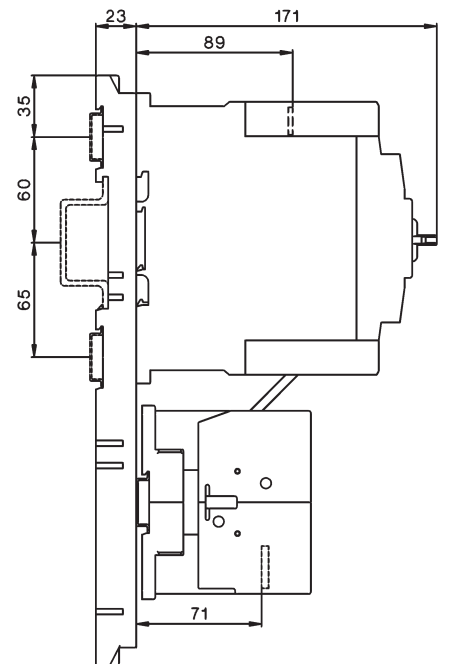
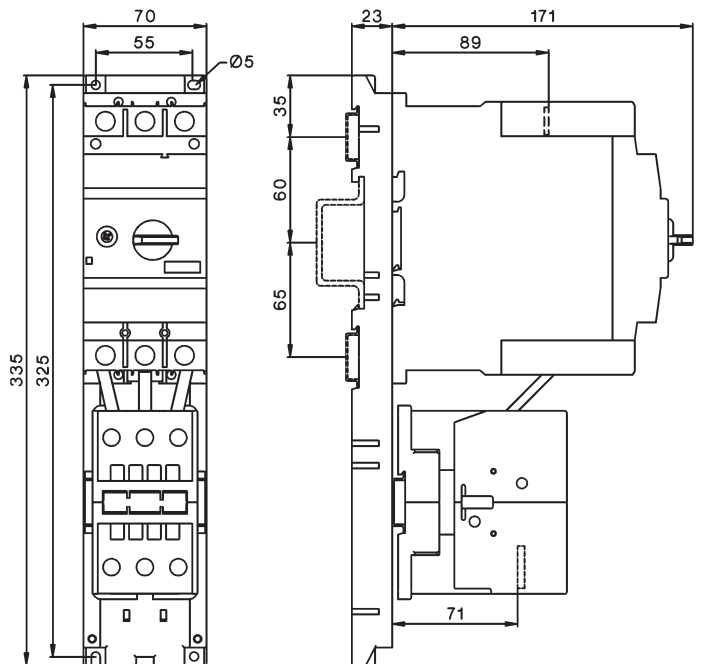

# Dimensions

## Enclosures

M4 32R PFH4  
M4 32R PFHN4

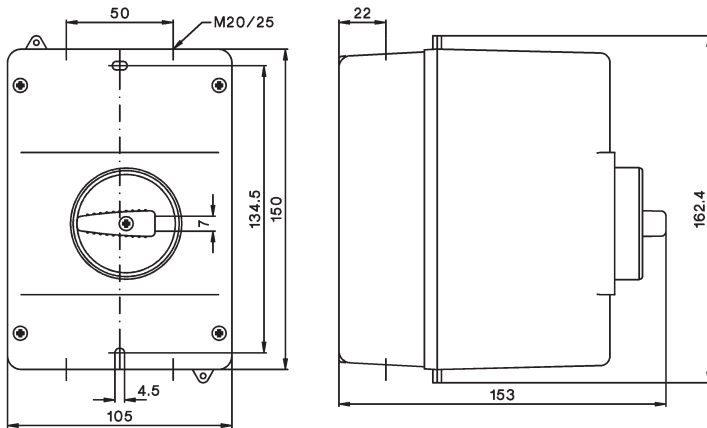

## Door-coupling rotary mechanisms

## Mounting holes

Type	A
M4 32R EH1 115	149 - 210
M4 32R EHN1 115	149 - 210
M4 32R EH1 315	149 - 410
M4 32R EHN1 315	149 - 410

Type	A
M4 63R EH1 115	194 - 255
M4 63R EHN1 115	194 - 255
M4 63R EH1 315	194 - 455
M4 63R EHN1 315	194 - 455

Type	A
M4 100R EH1 115	220 - 282
M4 100R EHN1 115	220 - 282
M4 100R EH1 315	220 - 482
M4 100R EHN1 315	220 - 482

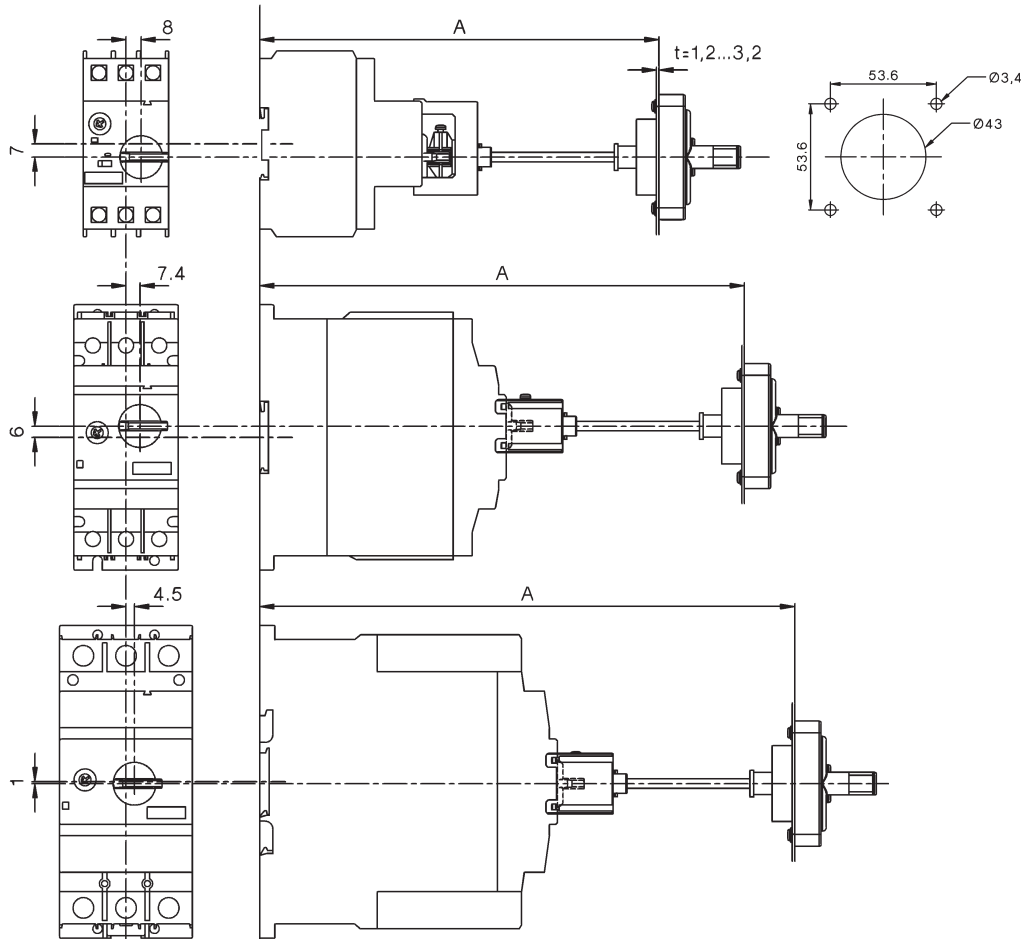

## Insulated 3-phase busbar system

M4 32 S..

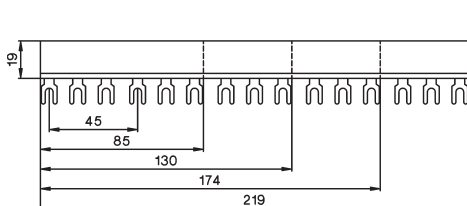

M4 32 SE

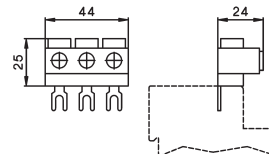

Index

Page



Manual Motors Starters

188

Contactor, Motor-Starter



Auxiliary Contact Blocks

188

Circuit Breakers



Shunt Release

189

Manual Motor-Starters



Under-voltage Release

189



Accessories

189

Switches



Busbar Connectors

189

AC-Main Switches



Enclosures

189

DC-Switch Disconnect



Technical Data

190

Push Buttons

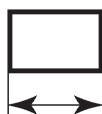

Dimensions

191

Representatives, Suppliers

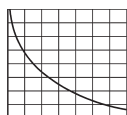

Tripping Characteristic

191

## Manual Motor Starters



Thermal Overload Release Setting Range A	Ratings AC3 at		Magnetic short circuit trip A	Type	Pack pcs.	Weight kg/pc.
	400V kW	690V kW				
0,16 - <b>0,25</b>	<b>0,06</b>	0,12	3,75	<b>MU25-0,25</b> <b>MU25-0,4</b>	1	0,25
0,25 - <b>0,4</b>	<b>0,09</b>	0,18	6		1	0,25
0,4 - <b>0,63</b>	<b>0,12</b>	0,25	7,45	<b>MU25-0,63</b> <b>MU25-1</b> <b>MU25-1,6</b>	1	0,25
0,63 - <b>1</b>	<b>0,25</b>	0,55	15		1	0,25
1 - <b>1,6</b>	<b>0,55</b>	1,1	24		1	0,25
1,6 - <b>2,5</b>	<b>0,75</b>	1,5	37,50	<b>MU25-2,5</b> <b>MU25-4</b> <b>MU25-6,3</b>	1	0,25
2,5 - <b>4</b>	<b>1,5</b>	3	60		1	0,25
4 - <b>6,3</b>	<b>2,5</b>	4	94,50		1	0,25
6,3 - <b>10</b>	<b>4</b>	7,5	150	<b>MU25-10</b> <b>MU25-16</b> <b>MU25-20</b>	1	0,25
10 - <b>16</b>	<b>7,5</b>	11	240		1	0,25
16 - <b>20</b>	<b>9</b>	12	300		1	0,25
20 - <b>25</b>	<b>12,5</b>	22	375	<b>MU25-25</b> <b>MU25-32</b>	1	0,25
25 - <b>32</b>	<b>15</b>		480		1	0,25

## Auxiliary Contact Blocks, for side mounting, max. 2 pieces



Contacts				Rated Operational Current AC15 230V			Type	Pack pcs.	Weight kg/pc.
NO	NC	EM <sup>1)</sup>	400V A	500V A	AC1 500V A				
1	1	-	3,5	2	6	<b>MU25-PS11</b>	10	0,03	

## System MU25

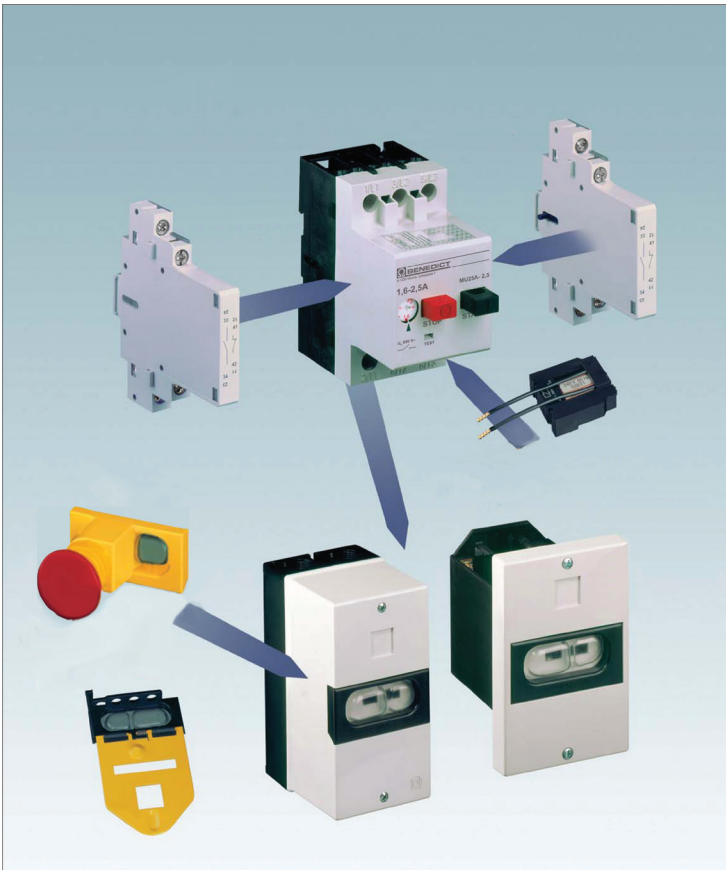

## Approvals

Country	USA, Canada UL	Europe
Type		

## Shunt Release for mounting under the cover



Rated Control Voltage and Frequency V	Power Consumption		Type	Pack pcs.	Weight kg/pc.
	VA	W			
110V 50Hz, 110-120V 60Hz	2,7	1,8	<b>MU25-A110</b>	10	0,06
220-230V 50Hz, 240V 60Hz	2,7	1,8	<b>MU25-A230</b>	10	0,06

## Under-voltage Release for mounting under the cover



Rated Control Voltage and Frequency V	Power Consumption		Type	Pack pcs.	Weight kg/pc.
	VA	W			
110V 50Hz, 110-120V 60Hz	2,7	1,8	<b>MU25-U110</b>	10	0,06
220-230V 50Hz, 240V 60Hz	2,7	1,8	<b>MU25-U230</b>	10	0,06
380-415V 50Hz, 440V 60Hz	2,7	1,8	<b>MU25-U400</b>	10	0,06

## Accessories



Description	Specification	Type	Pack pcs.	Weight kg/pc.
Busbar Connector Fully Isolated, Ui 690V, Iu 63A				
Busbar	for 2 units, 99mm long	<b>MU25A-D99</b>	10	0,036
Busbar	for 3 units, 154mm long	<b>MU25A-D154</b>	10	0,060
Busbar	for 4 units, 208mm long	<b>MU25A-D208</b>	10	0,084
Busbar	for 5 units, 262mm long	<b>MU25A-D262</b>	10	0,107
Supply Block	3-pole for use with busbar connector	<b>MU25A-DB</b>	10	0,034
Spacing piece ½TE	for ambient temperature >40°C	<b>P730</b>	10	0,013
<b>Enclosures</b>				
Moulded Enclosure	Protection to IP55	<b>MU25-O55</b>	1	0,24
Moulded Front Plate	Protection to IP55	<b>MU25-C55</b>	1	0,16
Locking Bracket	Suitable for 3 padlocks in "OFF"-position, stirrup diameter of the padlock max. 8 mm	<b>MU25-Z</b>	1	0,1
Emergency Stop Button	latch, release by turning	<b>MU25-NAV</b>	1	0,04

# Manual Motor Starters

Data according to IEC 947, IEC 204, EN 60947, EN 60204, VDE 0660, VDE 0113

Type	MU25			
<b>Main Contacts</b>				
<b>Rated insulation voltage <math>U_i</math></b>	V~ <sup>1)</sup>	690		
Rated operational current $I_e$ (=Ith) open, at 50°C	A	25 <sup>2)</sup>		
<b>Mechanical life</b>	S x 10 <sup>6</sup>	0,1		
<b>Contact life at <math>I_e</math> /AC3</b>	S x 10 <sup>6</sup>	0,1		
<b>Tripping class according to IEC 60947-4-1</b>		10A		
<b>Rated ultimate short-circuit breaking capacity <math>I_{cu}</math></b>		220-240V~	380-415V~	500V~
Values for open unit, when incoming supply on upper terminals				660-690V~
Setting range	bis 1A kA	50	50	50
	1 - 1,6A kA	50	50	50
	1,6 - 2,5A kA	50	50	3
				2,5
	2,5 - 4A kA	50	50	3
	4 - 6,3A kA	50	50	3
	6,3 - 10A kA	50	6	3
				2,5
	10 - 16A kA	10	6	2,5
	16 - 20A kA	10	6	2,5
	20 - 25A kA	10	6	2,5
	25 - 32A kA	10	6	2,5
				2
				2
				2
				2
<b>Short circuit protection</b>		220-240V~	380-415V~	500V~
Setting range	bis 1A A	-	-	-
	1 - 1,6A A	-	-	-
Fuse gL(gG) only necessary if the short circuit current could be greater than the rated ultimate short-circuit breaking capacity	1,6 - 2,5A A	-	-	25
				20
	2,5 - 4A A	-	-	35
	4 - 6,3A A	-	-	50
	6,3 - 10A A	-	80	50
				35
	10 - 16A A	80	80	63
	16 - 20A A	80	80	63
	20 - 25A A	80	80	63
	25 - 32A A	80	80	63
<b>Maximum ambient temperature Operation</b>	open °C		-25 bis +60	
	enclose °C		-25 bis +40	
Temperature compensation	°C		-5 bis +40	
Storage	°C		-25 bis +70	
<b>Power loss at rated current, warm condition</b>	W	6 - 8		
<b>Auxiliary Contacts</b>				
<b>Rated insulation voltage <math>U_i</math></b>	V~	500		
<b>Thermal rated current Ith Ambient temperature max. 50°C</b>	A	6		
<b>Utilization category AC15</b>				
<b>Rated operational current <math>I_e</math></b>	220-240V A	3,5		
	380-415V A	2		
	500V A	1,5		
<b>Short circuit protection max. fuse size</b>	gL (gG) A	6		
<b>Cable cross-section</b>				
<b>Main connector</b>	solid or stranded mm <sup>2</sup>	1 - 6		
	flexible mm <sup>2</sup>	1 - 4		
	flexible with multicore cable end mm <sup>2</sup>	0,75 - 4		
Number of clampable conductors per terminal / Screw torque		2 / M3 - Pz2	1,8Nm	
Auxiliary connector	solid or stranded mm <sup>2</sup>	0,75 - 2,5		
	flexible mm <sup>2</sup>	0,75 - 1,5		
	flexible with multicore cable end mm <sup>2</sup>	0,75 - 1,5		
Number of clampable conductors per terminal / Screw torque		2 / M3,5 - Pz1	1Nm	
<b>Resistance to shock according to IEC 68-2-27</b>	g	20		
vibration resistance to IEC68-2-6	g	5 (by f= 5...150Hz)		

1) Suitable for: earthed-neutral systems, overvoltage category I to III, pollution degree 3 (standard-industry):  $U_{imp} = 6kV$ .

2) Maximum number without gap: 3

# Manual Motor Starters

## Maße

Manual Motor Starter  
MU25

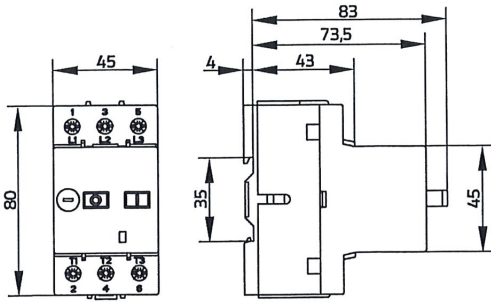

Moulded Enclosure  
MU25-O55

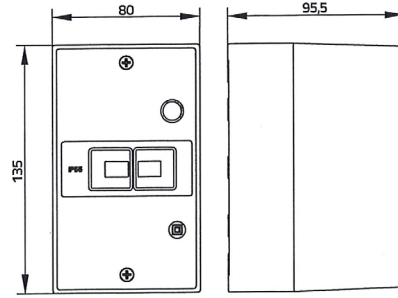

Moulded Front Plate  
MU25-C55

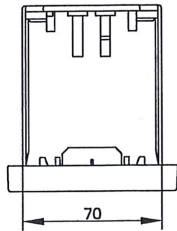
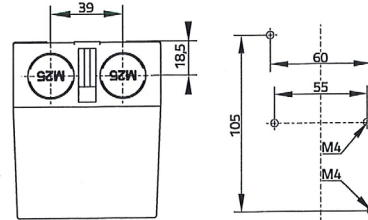
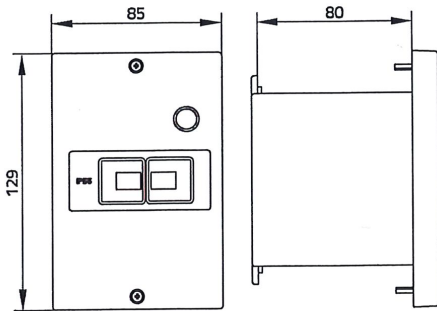

Mounting with clamps                      with screws

## Temperature Compensation

In case of higher ambient temperature use the following formula:  $(\text{Ambient temperature} - 20) \times 0,3 = \text{correction factor in \% of the full load motor current}$

Example:  
Ambient temperature 60°C, full load motor current 5A  
 $(60 - 20) \times 0,3 = 12\%$

## Tripping Characteristic

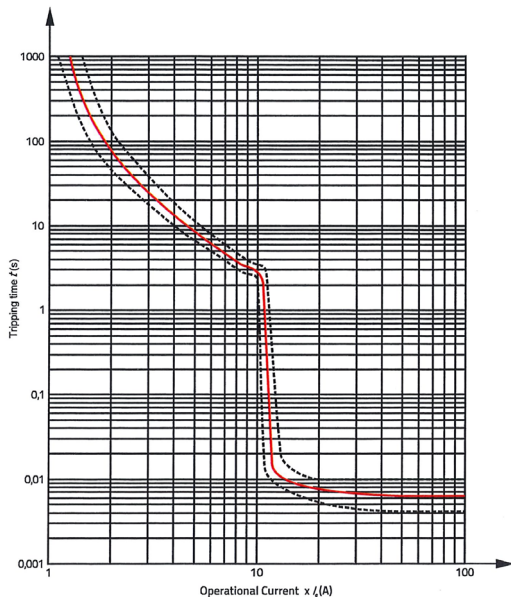

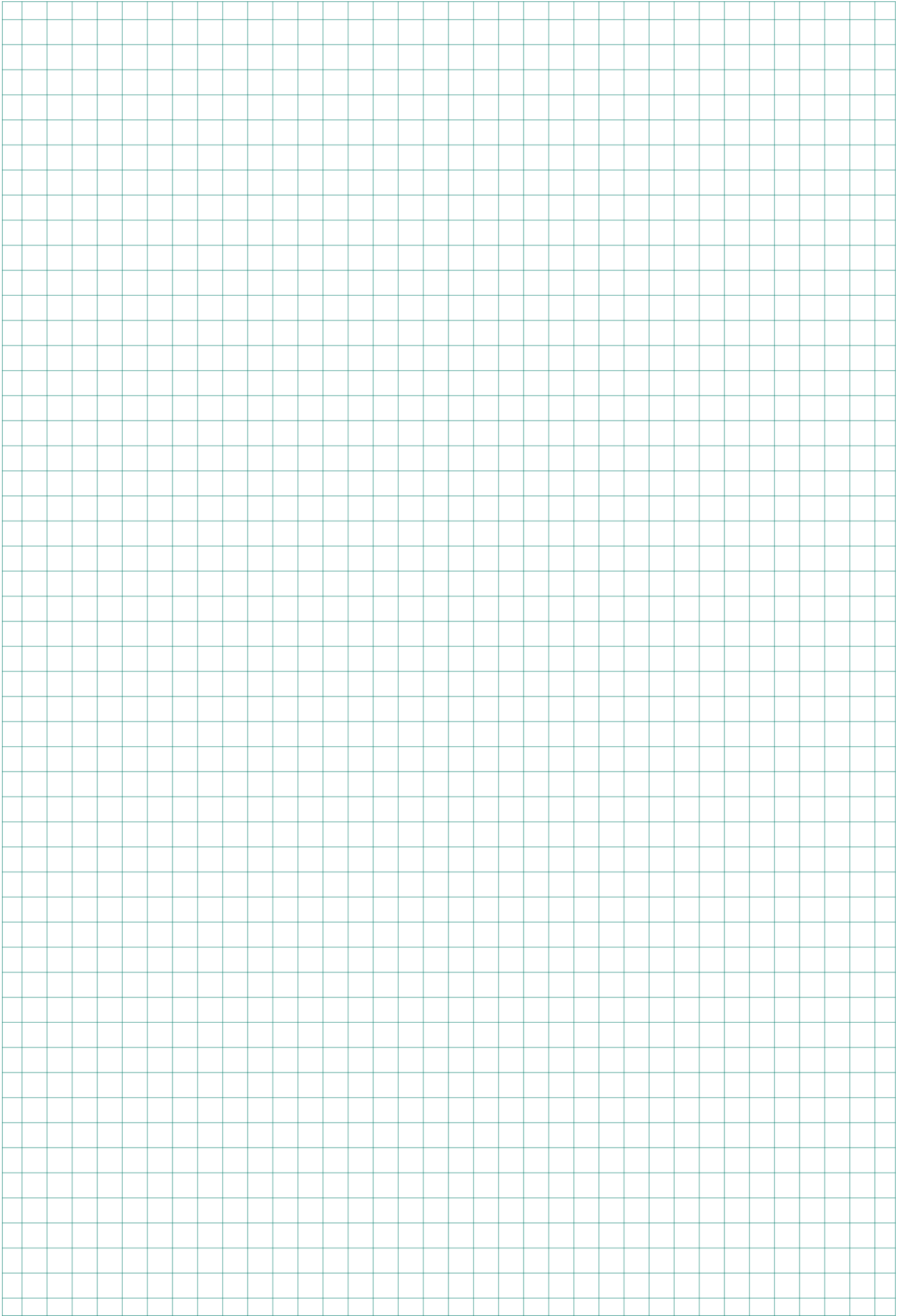

	<b>General</b>	194
	Approvals	195
	Informations	196
	Cam Switches	198
	Basic designs	200
<hr/>		
	<b>Cam Switches</b>	203
	On-Off switches, Changeover switches	203
	Star-Delta switches	207
	Multi speed switches	211
	Control switches	215
	Voltmeter selector switches	218
	Ammeter switches	219
	Gang switches	221
	Multi step switches	224
		
<hr/>		
	<b>Mini-Cam Switches</b>	236
	Technical data	236
	On-Off switches, Changeover switches	237
	Star-Delta switches	237
	Control switches	237
	Voltmeter selector switches, Ammeter switches	238
	Gang switches, Multi step switches	238
		
<hr/>		
	<b>Load switches</b>	240
	On-Off switches	240
	Changeover switches	241
		
<hr/>		
	<b>Handles and plates</b>	242
	Operating knobs and handles	242
	Escutcheon plates	243
	Standard Markings	244
	Angles of rotation	247
<hr/>		
	<b>Optional Extras</b>	249
	Drive units	249
	Door couplings	250
	Key operated switches	251
	Padlock devices	252
	Switch interlocks	253
	Couplings	254
	Accessories	256
 		
<hr/>		
	<b>Special switches</b>	257
<hr/>		
	<b>Technical data</b>	259
	Cam switches	259
	Load switches	260
<hr/>		
	<b>Dimensions</b>	262
	Cam switches	262
	Load switches	266
	Accessories	267

## General

### Test Authorities, Registration Mark, Approvals

Low voltage switchgear from Benedict GmbH is built and tested to national and international specifications. All devices suit all important specifications without any test obligation, like VDE, BS and also relative to IEC Recommendations and to European Standards like IEC 947 and EN 60947. It is for this reason of our Low voltage switchgear is used all over the world. In order to provide special versions, limitations to the max. voltages, currents and power ratings or special markings are sometimes necessary.

### Quality Control System

Since November 1991 Benedict GmbH has been certified according to the quality control system **ÖNORM EN ISO 29001**. The target of the ISO-certification is, to grant the customer the quality of the performance of his supplier, who is audited in accordance with this standard.

### CE-Marking



The manufacturer has to sign his products with the CE-Marking. With the CE-Marking the manufacturer confirms the accordance with the different EEC Directives. The CE-Marking is absolutely necessary to sell the products in the EEC.

Below you find the EEC Directives concerning our products.

Low Voltage Directive 2006/95/EC

EMC Directive 2004/108/EC

RoHS + WEEE 2002/95/EC + "002/96/EC

Country	North America	Russia
State deputy or private examination (state admitted)	UL Canada, USA	EAC
Label marking of examination boards	Listed Component	
Duty of approvals	all switchgear	all switchgear

### Explanations for choice and supply of low voltage switchgear in Canada and USA

#### Marking of auxiliary contacts

At several devices in UL-data are two voltages for auxiliary contacts mentioned (e. g.: 600 volts at same potential, 150 volts at different potentials). That means, if the voltage is higher than 150 volts, the control voltage applied to input terminals must be at the same potential.

Low voltage switchgear for auxiliary circuits (e. g. contactor relays, control units, auxiliary contacts in general) usually approved for "Heavy Duty" or "Standard Duty" UL and besides these marked with the admissible max. voltage or with short codes (see table).

Marking of auxiliary contacts according to CSA and UL	Max. rated values per pole			Cont. Current A	Contact Rating Code Designation
	Voltage V	Current Make A	Break A		
Heavy Duty (HD or HVY DTY)	AC 120	60	6	10	A150
	AC 240	30	3	10	A300
	AC 480	15	1,5	10	A600
	AC 600	12	1,2	10	A600
	DC 125	2,2	2,2	10	N150
	DC 250	1,1	1,1	10	N300
	DC 600	0,4	0,4	10	N600
Standard Duty (SD or STD DTY)	AC 120	30	3	5	B150
	AC 240	15	1,5	5	B300
	AC 480	7,5	0,75	5	B600
	AC 600	6	0,6	5	B600
	DC 125	1,1	1,1	5	P150
	DC 250	0,55	0,55	5	P300
	DC 600	0,2	0,2	5	P600
-	AC 120	15	1,5	2,5	C150
	AC 240	7,5	0,75	2,5	C300
	AC 480	3,75	0,375	2,5	C600
	AC 600	3	0,3	2,5	C600
	DC 125	0,55	0,55	2,5	Q150
	DC 250	0,27	0,27	2,5	Q300
	DC 600	0,1	0,1	2,5	Q600
-	AC 120	3,6	0,6	1	D150
	AC 240	1,8	0,3	1	D300
	DC 125	0,22	0,22	1	R150
	DC 250	0,11	0,11	1	R300
-	AC 120	1,8	0,3	0,5	E150

#### Discernment at UL-Standards

##### Recognized Component Industrial Control Equipment

UL issues yellow "Guide cards" with Guide- and File-No.

Devices have permission to be marked with the label

Devices as components approved for "factory wiring": devices for employment in control panels, when they are selected, mounted and wired according to the charging conditions by skilled worker.

Valid UL-Standards:  
UL 508 "Standard for Industrial Control Equipment" (partly limited)

##### Listed Industrial Control Equipment

UL issues white "Guide cards" with Guide- and File-No.





Devices have to be marked with the "UL-Listing Mark"

Devices approved for "field wiring",  
a) devices for employment in control panels, when they are mounted and wired by skilled worker.  
b) devices for retail in USA

Valid UL-Standards:  
UL 508 "Standard for Industrial Control Equipment" (unlimited)

Are devices approved as "Listed Equipment" the approval is also valid for using as "Recognized Component" .

# Approvals

Country	USA, Canada UL	Europe	Russia EAC	CB/CCA- Certificates	China
Type					
<b>Cam Switches</b> (UL-Listed as MANUAL MOTOR CONTROLLER and suitable as MOTOR DISCONNECT)					
M10	o	/	o	o	-
M10H	o	/	o	o	o
M20	o	/	o	o	o
N20	o	/	o	o	o
N33F	o	/	o	o	o
N40	-	/	o	o	-
N61	o	/	o	o	-
N80	o	/	o	o	-
N100	o	/	o	o	-
N200	o	/	o	o	-
L400	o	/	-	-	-

o In standard version approved / No testing required CE x In test  
 - Not provided for test till now

## Technical Information

### Degree of protection acc. to IEC 60947-1

Protection ratings are prefixed by the internationally agreed letters IP followed by two digits.

1<sup>st</sup> digit: Pertains to solid objects  
2<sup>nd</sup> digit: Pertains to water.

1 <sup>st</sup> digit	Short description	Definition
1	Protected against solid objects greater than 50 mm	Excludes solid objects exceeding 50 mm in diameter and protects against contact with live and moving parts by a large surface such as a hand (but not against deliberate access).
2L	Protected against solid objects greater than 12,5 mm and against contact by standard test finger	Excludes solid objects exceeding 12,5 mm in diameter and protects against contact with live and moving parts by a standard test finger or similar objects not exceeding 80 mm in length.
3	Protected against solid objects	Excludes solid objects exceeding 2,5 mm in diameter or thickness. greater than 2,5mm
4	Protected against solid objects greater than 1 mm	Excludes solid objects exceeding 1 mm in diameter or thickness.
5	Dust protected	Prevents ingress of dust in quantities and locations that would interfere with the intended operation of the equipment.
6	Dust tight	Prevents ingress of dust.

### Resistance to climatic conditions acc. to IEC60068

Open-type devices are climate-resistant in the constant climate according to IEC60068-2-3 (this is a climate with an ambient temperature of 40°C and an atmospheric humidity of 90 to 95%).

Enclosed devices are climate-resistant in an alternating climate according to IEC 68-2-30 (this is a moist alternating climate with a 24-hour cycle between climates with an ambient temperature of 25°C, and an atmospheric humidity of 95 to 100% and an ambient temperature of 40°C, and an atmospheric humidity of 90 to 96% in the presence of condensation during rises in temperature).

Data are valid up to an altitude of 2000m above sea level.

### Short circuit protection

Backup fuses should be used to protect contactors and starters against short circuits. For starters the device with the smaller admissible fuse at the main and at the control circuit (contactor or thermal overload) determines the fuse size.

After a short circuit devices have to be checked for correct operation. Disconnect power before proceeding with any work on the equipment!

### Mounting positions

No limitations, all kind of positions allowed.













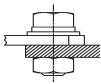

2 <sup>nd</sup> digit	Short description	Definition
1	Protected against dripping water	Dripping water (vertically falling drops) shall have no harmful effect.
2	Protected against dripping water when tilted up to 15°	Vertically dripping water shall have no harmful effect when the enclosure is tilted at any angle up to 15° from its normal position.
3	Protected against spraying water	Water falling as a spray at an angle up to 60° from the vertical shall have no harmful effect.
4	Protected against splashing water	Water splashed against the enclosure from any direction shall have no harmful effect.
5	Protected against water jets	Water protected by a nozzle against the enclosure from any direction shall have no harmful effect.
6	Protected against heavy seas	Water from heavy seas or water projected in powerful jets shall not enter the enclosure in harmful quantities.
7	Protected against the effects of immersion	Ingress of water in a harmful quantity shall not be possible when the enclosure is immersed in water under standard conditions of pressure and time.
8	Protected against submersion	No ingress of water.

### Suitable ambient temperatures:

Operation	open °C	-40 up to +60
	enclosed °C	-40 up to +40
Storage	°C	-50 up to +90

# Technical Information

## Terminal screws

Devices Type	Kind of connection Screw with washer	2 Screw s		Screw with w. nut	Screw driver	Tightening torque	
						Nm	lb. inch
							
<b>Cam Switches</b>							
M4H..	M2,5	-	-	 Pz1	0,6	5	
M10	M3	-	-	 Pz2	0,6 - 1,2	5 - 11	
M10H, M10HD	M3,5	-	-	 Pz2	0,8 - 1,4	7 - 12	
M20, N20, N33F	M4	-	-	 Pz2	1,2 - 1,8	11 - 16	
N40	M5	-	-	 Pz2	2,5 - 3	22 - 26	
N61, N80	-	2 x M5	-	 Pz2	2,5 - 3	22 - 26	
N100	-	2 x M6	-	 Pz3	3,5 - 4,5	31 - 40	
N200	-	-	M10		10	88	
L400	-	-	M12		16	140	
L600	-	-	M16		24	210	
L800	-	-	M16		24	210	
L1200	-	-	M16		24	210	

Contactors, Motor-Starter

Circuit Breakers

Manual Motor-Starters

Switches

AC-Main Switches

DC-Switch Disconnect

Push Buttons

Representatives, Suppliers

Ratings								Designs			
Typ	Rated current			Motor			Plate mm	Panel moun. M10H, M20 IP65 IP40	Single hole mount. Ø22,5mm with Plate IP65	without Plate IP65	Flush mount. IP40
	Therm. $I_{th}$ open A	AC21 A	at $U_e$ V	AC3 3~400V kW	AC23 3~400V A	3~400V kW		IP40	IP65	IP65	IP40
<b>M4H</b>	10	<b>10</b>	440	2,2	6	3	30□	M4H E	M4H Z	M4H ZO	-
<b>M10H</b>	20	<b>20</b>	690	5,5	16	7,5	48□	M10H E	M10H Z	M10H ZO	-
<b>M10HD</b> <sup>1)</sup>	10	<b>10</b>	690	-	-	-	48□	M10HD E	M10HD Z	M10HD ZO	-
<b>M10</b>	20	<b>20</b>	440	5,5	16	7,5	48□	-	-	-	M10 UP
<b>M20</b>	32	<b>32</b>	690	11	30	15	48□	M20 E	M20 Z	M20 ZO	-
<b>N20</b>	32	<b>32</b>	690	11	30	15	64□	N20 E	-	-	-
<b>N33F</b>	50	<b>50</b>	690	15	45	22	64□	N33F E	N33F Z	-	-
<b>N40</b>	63	<b>63</b>	690	15	45	22	88□	N40 E	-	-	-
<b>N61</b>	90	<b>85</b>	690	25	60	30	88□	N61 E	-	-	-
<b>N80</b>	115	<b>115</b>	690	30	85	45	88□	N80 E	-	-	-
<b>N100</b>	150	<b>150</b>	690	40	110	55	132□	N100 E	-	-	-
<b>N200</b>	250	<b>250</b>	690	70	140	70	132□	N200 E	-	-	-
<b>L400</b>	<b>400</b>	<b>400</b>	690	70	140	70	132□	L400 E	-	-	-
<b>L600</b>	<b>600</b>	<b>400</b>	690	70	140	70	132□	L600 E	-	-	-
<b>L800</b>	<b>800</b>	<b>400</b>	690	70	140	70	132□	L800 E	-	-	-
<b>L1200</b>	<b>1200</b>	<b>400</b>	690	70	140	70	132□	L1200 E	-	-	-

### Cam Switches 10 - 250A

Cam switches can be used for virtually all purposes, e.g. as motor, main, control or instrument switches. Over and above the switching programs mentioned in the list, an effectively limitless number of special programs can be implemented.

### Load switch L.. 400 - 1200A

Load switches are primarily employed where resistive or slightly inductive current loads are to be switched on and off, or switching takes place without loading. Load switches are assembled by parallel switching of two or more of cam switch contacts. With customer built main terminal protection, load switch L.. can also be used as main switch.

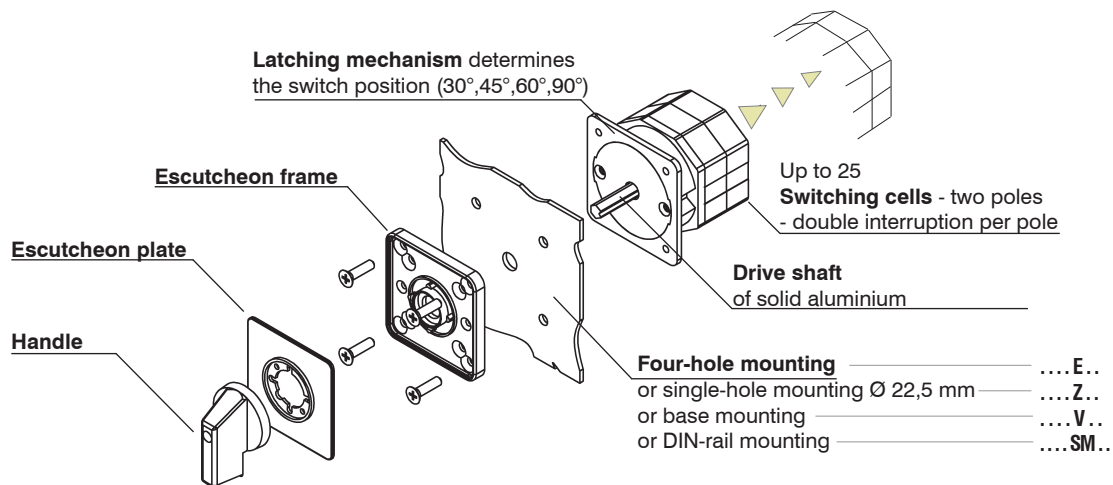

1) Control Switches with double contacts for highest contact reliability.

Designs	DIN-rail mounting IP40	Modular IP40	Plastic enclosed ..P.. IP40 ..PF.. IP65	horizontal, IP65	Motor switch enclosed IP65	Terminal box mounting IP65
M10H V ♦ M10HD V ♦	M10H SM ♦ M10HD SM ♦	M10H SMA ♦ M10HD SMA ♦	- M10 P(F) ♦	- -	M10 PM ♦	- M10 KE ♦
M20 V ♦	M20 SM ♦	M20 SMA ♦	-	-	-	-
N20 V ♦ N33F V ♦	N20 SM ♦ N33F SM ♦	-	N20 P(F) ♦ N33F P(F) ♦	-	N20 PM ♦	N20 KE ♦
N40 V ♦ N61 V ♦ N80 V ♦	-	-	N40 P(F) ♦	N40 PLF ♦ N61 PLF ♦ N80 PLF ♦	-	-
N100 V ♦ N200 V ♦	-	-	-	-	-	-
L400 V ♦ L600 V ♦	-	-	-	-	-	-
L800 V ♦ L1200 V ♦	-	-	-	-	-	-

**Ordering**

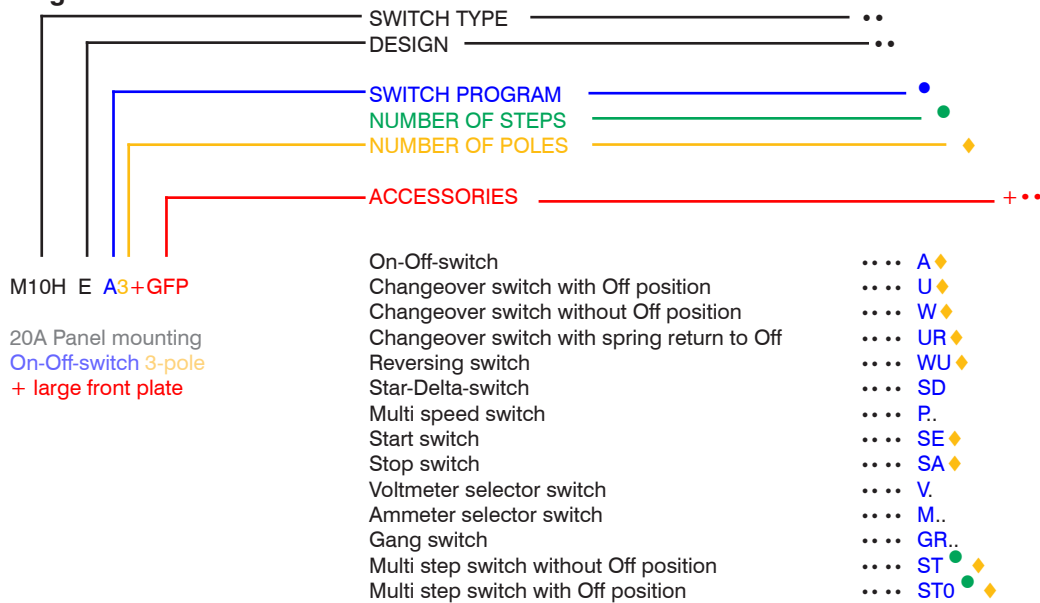

## Panel mounting designs

Switches of the panel mounting designs listed below have protection from front IP40. Where a shaft seal (appendix +WD) is used, the protection is increased to IP54. Use of a moisture proofing cap (appendix +FR) results in an increase in rear protection to IP54. In the standard version, the switches are delivered with a square escutcheon plate and black instrument knob. Forward mounting is possible for some of the design

E switches. The position of the terminals of the standard switches is left and right, at switch M10H the terminals are above and below. Where a knob insert is turned by 90° (can easily be performed after delivery), the position of the terminals can be changed.

**Dimensions** see page 262.



### Design

Description	Type appendix	Possible switch sizes					
		M10H M10HD	M20	N20 N33F	N40 N61 N80	N100 N200	L...
<b>Panel mounting</b> For installation in control panels, machines and equipment. For panel thickness of over 5mm, an extended switch shaft is required (appendix +VW). Protection from front: M10H, M20 IP65 all others IP40	<b>E</b>	X	X	X	X	X	X
<b>Central fixing 22,5mm</b> Switch for mounting with standard 22,5mm mounting holes and 1-4mm panel thickness. Protection from front: IP65 Wrench J7049 necessary	<b>Z</b>	X	X	X <sup>2)</sup>	-	-	-
<b>Central fixing 22,5mm</b> Switch <b>without escutcheon plate</b> , for installation with standard 22,5mm mounting holes and 1-4mm panel thickness. Protection from front: IP65 Wrench J7049 necessary	<b>ZO</b>	X	X	-	-	-	-
<b>Flush mounting version</b> Switch with white instrument knob, cream escutcheon plate with black markings, for installation in 65mm flush mounting boxes and use of Unitas plate. Supplied with flush mounting box: appendix +UP. Maximum number of cells with: M10 FM box 45mm deep 2 FM box 65mm deep 4	<b>UP</b>	X <sup>1)</sup>	-	-	-	-	-

1) Switches are delivered with switch type M10



2) For switch types N33F only, max. 3 cells

## Base mounting designs

Switches of the designs listed below have protection from front IP40. When a shaft seal (appendix +WD) is used, the front protection type is increased to IP54. In the standard version, the switches are delivered with a square escutcheon plate and black instrument knob (design SMA with grey cover and grey toggle knob). Door couplings are advisable for switchgear cabinets with hinged doors.



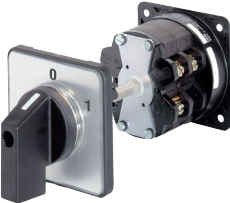
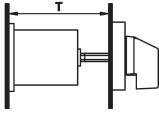

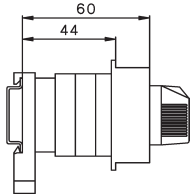
The position of the terminals of the standard switches is left and right, at switch M10H the terminals are above and below. Where a knob insert is turned by 90° (can easily be performed after delivery), the position of the terminals can be changed.

**Dimensions** see page 263.

Design	Possible switch sizes	Possible switch sizes					
		Type appendix	M10H	M20	N20 N33F	N40 N61 N80	N100 N200
 <p><b>Base mounting</b> For screw mounting to the back wall or floor of distributor boxes, or of appliances with removable lids. Additionally it is possible to state the installation depth - that is the distance between mounting level of the switch and the inside edge of the door (dimension T).</p>  <p>Door couplings see page 250.</p>	V ... +T/...	X	X	X	X	X	X
 <p><b>Snap-on mounting on DIN-rail</b> with installation cover for standard opening and toggle knob. The lay-out of the terminals of the standard switches is above and below. Dimensions for Switch types M10H SMA .. with 1-3 cells M20 SMA .. with 1 or 2 cells</p>  <p>Further dimensions see page 263.</p>	SMA	X	X	-	-	-	-

## Plastic enclosed switches

The switches, which have durable plastic enclosures, are intended for wall mounting or attachment to machines. In the standard version, they are supplied with a light-grey enclosure, square escutcheon plate, black markings on a silver background, and a black instrument knob. Other colours and colour combinations are available for most enclosure types. It is not possible to mount an additional rectangular plate. The enclosure base is equipped with 4 entry glands with heavy-gauge conduit threads (see drawings). In all types of plastic enclosures, two terminals that are connected and insulated from switch column can be provided for a PE conductor (appendix +PE). **Dimensions** see page 264.

Design	Type appendix	Possible switch sizes						
		M10H	N20	N33F	N40	N61	N80	N100
 <p><b>Plastic enclosure</b> light grey Protection class IP40 Maximum number of cells</p>	<b>P</b>	X	X	X	X	-	-	-
 <p><b>Plastic enclosure</b> light grey Moisture protection Protection class IP65 Maximum number of cells</p>	<b>PF</b>	X	X	X	X	-	-	-
 <p><b>Plastic enclosure horizontal</b> light grey Moisture protection Protection class IP65 Maximum number of cells</p>	<b>PLF</b>	-	-	-	X	X	X	-
 <p><b>Terminal box mounting</b> Protection class IP65 These switches are front mounted on a terminal box. The switch cells protrude through a hole into the terminal compartment. Maximum number of cells</p>	<b>KE</b>	X	X	-	-	-	-	-
 <p><b>Plastic motor switch enclosure</b> Moisture protection Protection class IP65 Maximum number of cells</p>	<b>PM</b>	-	X	-	-	-	-	-

## Switching programs

Description	Wiring diagram	Switching angle	Number of cells ↓ Size ↓ AC21	Type	Design					Switch pro-	Escutcheon plate	
					E.	Z.	V.	SMA.	P.			
<b>On-Off-switches A</b>												
1-pole		60°	1	48 □ 20A	M10H .	x	x	x	x	x <sup>1)</sup>	. A1	
				32A	M20 .	x	x	x	x	-	. A1	
				64 □ 32A	N20 .	x	-	x	-	x	. A1	
				50A	N33F .	x	x	x	-	x	. A1	
				88 □ 63A	N40 .	x	-	x	-	x	. A1	
90A	N61 .	x	-	x	-	x	. A1					
115A	N80 .	x	-	x	-	-	. A1					
132 □ 150A	N100 .	x	-	x	-	-	. A1					
250A	N200 .	x	-	x	-	-	. A1					
2-pole		60°	1	48 □ 20A	M10H .	x	x	x	x	x <sup>1)</sup>	. A2	
				32A	M20 .	x	x	x	x	-	. A2	
				64 □ 32A	N20 .	x	-	x	-	x	. A2	
				50A	N33F .	x	x	x	-	x	. A2	
				88 □ 63A	N40 .	x	-	x	-	x	. A2	
90A	N61 .	x	-	x	-	x	. A2					
115A	N80 .	x	-	x	-	-	. A2					
132 □ 150A	N100 .	x	-	x	-	-	. A2					
250A	N200 .	x	-	x	-	-	. A2					
3-pole		60°	2	48 □ 20A	M10H .	x	x	x	x	x <sup>1)</sup>	. A3	
				32A	M20 .	x	x	x	x	-	. A3	
				64 □ 32A	N20 .	x	-	x	-	x	. A3	
				50A	N33F .	x	x	x	-	x	. A3	
				88 □ 63A	N40 .	x	-	x	-	x	. A3	
90A	N61 .	x	-	x	-	x	. A3					
115A	N80 .	x	-	x	-	-	. A3					
132 □ 150A	N100 .	x	-	x	-	-	. A3					
250A	N200 .	x	-	x	-	-	. A3					
4-pole 4. pole early make		60°	2	48 □ 20A	M10H .	x	x	x	x	x <sup>1)</sup>	. A4	
				32A	M20 .	x	x	x	x	-	. A4	
				64 □ 32A	N20 .	x	-	x	-	x	. A4	
				50A	N33F .	x	-	x	-	x	. A4	
				88 □ 63A	N40 .	x	-	x	-	x	. A4	
90A	N61 .	x	-	x	-	x	. A4					
115A	N80 .	x	-	x	-	-	. A4					
132 □ 150A	N100 .	x	-	x	-	-	. A4					
250A	N200 .	x	-	x	-	-	. A4					
6-pole		60°	3	48 □ 20A	M10H .	x	x	x	x	x <sup>1)</sup>	. A6	
				32A	M20 .	x	x	x	x	-	. A6	
				64 □ 32A	N20 .	x	-	x	-	x	. A6	
				50A	N33F .	x	-	x	-	x	. A6	
				88 □ 63A	N40 .	x	-	x	-	x	. A6	
90A	N61 .	x	-	x	-	x	. A6					
115A	N80 .	x	-	x	-	-	. A6					
132 □ 150A	N100 .	x	-	x	-	-	. A6					
250A	N200 .	x	-	x	-	-	. A6					

**Ordering example:** AC21 250A panel mounting, On-Off-switch 6-pole, Escutcheon plate OFF - ON N200 E A6+003

1) Plastic enclosed switches are delivered with switch type M10.

## Switching programs

Description	Wiring diagram	Switching angle	Number of cells ↓ Size ↓ AC21	Type	Design				Switch pro-	Escutcheon plate	
					E.	Z.	V.	SMA.			P.
<b>Changeover switches U</b>											
1-pole		60°	1 48 □ 20A	M10H .	x	x	x	x	x <sup>1)</sup>	. U1	
			32A	M20 .	x	x	x	x	-	. U1	
			64 □ 32A	N20 .	x	-	x	-	x	. U1	
			50A	N33F .	x	x	x	-	x	. U1	
88 □ 63A	N40 .	x	-	x	-	x	. U1	+007			
90A	N61 .	x	-	x	-	x	. U1				
115A	N80 .	x	-	x	-	-	. U1				
132 □ 150A	N100 .	x	-	x	-	-	. U1	. U1	. U1		
250A	N200 .	x	-	x	-	-	. U1				
2-pole		60°	2 48 □ 20A	M10H .	x	x	x	x	x <sup>1)</sup>	. U2	
			32A	M20 .	x	x	x	x	-	. U2	
			64 □ 32A	N20 .	x	-	x	-	x	. U2	
			50A	N33F .	x	x	x	-	x	. U2	
88 □ 63A	N40 .	x	-	x	-	x	. U2	+007			
90A	N61 .	x	-	x	-	x	. U2				
115A	N80 .	x	-	x	-	-	. U2				
132 □ 150A	N100 .	x	-	x	-	-	. U2	. U2	. U2		
250A	N200 .	x	-	x	-	-	. U2				
3-pole		60°	3 48 □ 20A	M10H .	x	x	x	x	x <sup>1)</sup>	. U3	
			32A	M20 .	x	x	x	x	-	. U3	
			64 □ 32A	N20 .	x	-	x	-	x	. U3	
			50A	N33F .	x	x	x	-	x	. U3	
88 □ 63A	N40 .	x	-	x	-	x	. U3	+007			
90A	N61 .	x	-	x	-	x	. U3				
115A	N80 .	x	-	x	-	-	. U3				
132 □ 150A	N100 .	x	-	x	-	-	. U3	. U3	. U3		
250A	N200 .	x	-	x	-	-	. U3				
4-pole 4. pole early make		60°	4 48 □ 20A	M10H .	x	x	x	x	x <sup>1)</sup>	. U4	
			32A	M20 .	x	x	x	x	-	. U4	
			64 □ 32A	N20 .	x	-	x	-	x	. U4	
			50A	N33F .	x	-	x	-	x	. U4	
88 □ 63A	N40 .	x	-	x	-	x	. U4	+007			
90A	N61 .	x	-	x	-	x	. U4				
115A	N80 .	x	-	x	-	-	. U4				
132 □ 150A	N100 .	x	-	x	-	-	. U4	. U4	. U4		
250A	N200 .	x	-	x	-	-	. U4				
6-pole		60°	6 48 □ 20A	M10H .	x	x	x	-	x <sup>1)</sup>	. U6	
			32A	M20 .	x	x	x	-	-	. U6	
			64 □ 32A	N20 .	x	-	x	-	x	. U6	
			50A	N33F .	x	-	x	-	x	. U6	
88 □ 63A	N40 .	x	-	x	-	x	. U6	+007			
90A	N61 .	x	-	x	-	x	. U6				
115A	N80 .	x	-	x	-	-	. U6				
132 □ 150A	N100 .	x	-	x	-	-	. U6	. U6	. U6		
250A	N200 .	x	-	x	-	-	. U6				

Ordering example: AC21 250A panel mounting, changeover switch 6-pole, Escutcheon plate 1 - OFF - 2

N200 E U6+007

1) Plastic enclosed switches are delivered with switch type M10.

## Switching programs

Description	Wiring diagram	Switching angle	Number of cells ↓ Size ↓ AC21	Type	Design				Switch pro-	Escutcheon plate		
					E.	Z.	V.	SMA.			P.	
<b>Changeover switches without off W</b>												
1-pole		60°	1	48 □ 20A	M10H .	x	x	x	x	x <sup>1)</sup>	. W1	
				32A	M20 .	x	x	x	x	-	. W1	
				64 □ 32A	N20 .	x	-	x	-	x	. W1	
				50A	N33F .	x	x	x	-	x	. W1	
88 □ 63A	N40 .	x	-	x	-	x	. W1					
90A	N61 .	x	-	x	-	x	. W1					
115A	N80 .	x	-	x	-	-	. W1					
132 □ 150A	N100 .	x	-	x	-	-	. W1					
250A	N200 .	x	-	x	-	-	. W1					
2-pole		60°	2	48 □ 20A	M10H .	x	x	x	x	x <sup>1)</sup>	. W2	
				32A	M20 .	x	x	x	x	-	. W2	
				64 □ 32A	N20 .	x	-	x	-	x	. W2	
				50A	N33F .	x	x	x	-	x	. W2	
88 □ 63A	N40 .	x	-	x	-	x	. W2					
90A	N61 .	x	-	x	-	x	. W2					
115A	N80 .	x	-	x	-	-	. W2					
132 □ 150A	N100 .	x	-	x	-	-	. W2					
250A	N200 .	x	-	x	-	-	. W2					
3-pole		60°	3	48 □ 20A	M10H .	x	x	x	x	x <sup>1)</sup>	. W3	
				32A	M20 .	x	x	x	x	-	. W3	
				64 □ 32A	N20 .	x	-	x	-	x	. W3	
				50A	N33F .	x	x	x	-	x	. W3	
88 □ 63A	N40 .	x	-	x	-	x	. W3					
90A	N61 .	x	-	x	-	x	. W3					
115A	N80 .	x	-	x	-	-	. W3					
132 □ 150A	N100 .	x	-	x	-	-	. W3					
250A	N200 .	x	-	x	-	-	. W3					
4-pole 4. pole early make		60°	4	48 □ 20A	M10H .	x	x	x	x	x <sup>1)</sup>	. W4	
				32A	M20 .	x	x	x	x	-	. W4	
				64 □ 32A	N20 .	x	-	x	-	x	. W4	
				50A	N33F .	x	-	x	-	x	. W4	
88 □ 63A	N40 .	x	-	x	-	x	. W4					
90A	N61 .	x	-	x	-	x	. W4					
115A	N80 .	x	-	x	-	-	. W4					
132 □ 150A	N100 .	x	-	x	-	-	. W4					
250A	N200 .	x	-	x	-	-	. W4					
6-pole		60°	6	48 □ 20A	M10H .	x	x	x	-	x <sup>1)</sup>	. W6	
				32A	M20 .	x	x	x	-	-	. W6	
				64 □ 32A	N20 .	x	-	x	-	x	. W6	
				50A	N33F .	x	-	x	-	x	. W6	
88 □ 63A	N40 .	x	-	x	-	x	. W6					
90A	N61 .	x	-	x	-	x	. W6					
115A	N80 .	x	-	x	-	-	. W6					
132 □ 150A	N100 .	x	-	x	-	-	. W6					
250A	N200 .	x	-	x	-	-	. W6					

**Ordering example:** AC21 250A panel mounting, changeover switch without off 6-pole, **N200 E W6**

1) Plastic enclosed switches are delivered with switch type M10.



## Switching programs

Description	Wiring diagram	Switching angle	Number of cells ↓ Size ↓ AC21	Type	Design E. Z. V. SMA. P. ↓ ↓ ↓ ↓ ↓	Switch pro-	Escutcheon plate	
<b>Reversing switches WU</b>								
2-pole		60°	2	48 □ 20A	M10H . x x x x x <sup>1)</sup>	. WU2		
				32A	M20 . x x x x -	. WU2		
				64 □ 32A	N20 . x - x - x	. WU2		
				50A	N33F . x x x - x	. WU2		
				88 □ 63A	N40 . x - x - x	. WU2		
90A	N61 . x - x - x	. WU2						
115A	N80 . x - x - -	. WU2						
132 □ 150A	N100 . x - x - -	. WU2	+007 					
250A	N200 . x - x - -	. WU2						
2-pole without off cross switch		60°		2	48 □ 20A	M10H . x x x x x <sup>1)</sup>	. WK2	
					32A	M20 . x x x x -	. WK2	
					64 □ 32A	N20 . x - x - x	. WK2	
			50A		N33F . x x x - x	. WK2		
			88 □ 63A		N40 . x x - - x	. WK2		
90A	N61 . x - x - x	. WK2						
115A	N80 . x - x - -	. WK2						
132 □ 150A	N100 . x - x - -	. WK2						
250A	N200 . x - x - -	. WK2						
2-pole with spring return from both sides to off		30°	2	48 □ 20A	M10H . x x x x x <sup>1)</sup>	. WU2R2		
				32A	M20 . x x x x -	. WU2R2		
				64 □ 32A	N20 . x - x - x	. WU2R2		
50A	N33F . x x x - x	. WU2R2						
88 □ 63A	N40 . x - x - x	. WU2R2						
2-pole position 1 latched position 2 with spring return to off		60°+30°	2	48 □ 20A	M10H . x x x x x <sup>1)</sup>	. WU2R1		
				32A	M20 . x x x x -	. WU2R1		
				64 □ 32A	N20 . x - x - x	. WU2R1		
50A	N33F . x x x - x	. WU2R1						
88 □ 63A	N40 . x - x - x	. WU2R1						
3-pole		60°	3	48 □ 20A	M10H . x x x x x <sup>1)</sup>	. WU3		
				32A	M20 . x x x x -	. WU3		
				64 □ 32A	N20 . x - x - x	. WU3		
				50A	N33F . x x x - x	. WU3		
				88 □ 63A	N40 . x - x - x	. WU3		
90A	N60 . x - x - x	. WU3						
115A	N80 . x - x - -	. WU3						
132 □ 150A	N100 . x - x - -	. WU3	+007 					
250A	N200 . x - x - -	. WU3						
3-pole with spring return from both sides to off		30°		3	48 □ 20A	M10H . x x x x x <sup>1)</sup>	. WU3R2	
					32A	M20 . x x x x -	. WU3R2	
					64 □ 32A	N20 . x - x - x	. WU3R2	
50A	N33F . x x x - x	. WU3R2						
88 □ 63A	N40 . x - x x	. WU3R2						
3-pole position 1 latched position 2 with spring return to off		60°+30°	3	48 □ 20A	M10H . x x x x x <sup>1)</sup>	. WU3R1		
				32A	M20 . x x x x -	. WU3R1		
				64 □ 32A	N20 . x - x - x	. WU3R1		
50A	N33F . x - x - x	. WU3R1						
88 □ 63A	N40 . x - x - x	. WU3R1						

**Ordering example:** AC21 63A base mounting, reversing switch 3-pole, position 2 with spring to off **N40 V WU3R1**

1) Plastic enclosed switches are delivered with switch type M10.

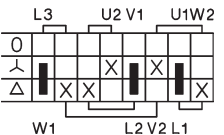
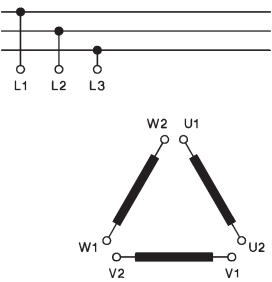
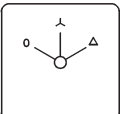
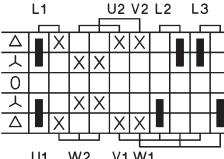
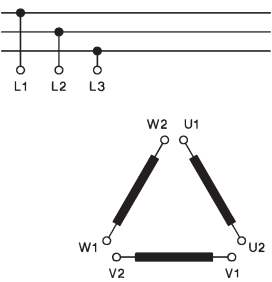
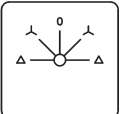
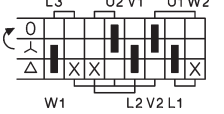
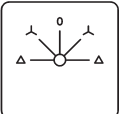
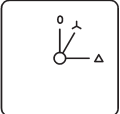
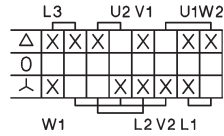
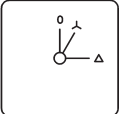
## Switching programs









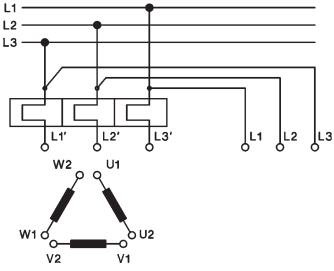

Description	Wiring diagram	Switching angle	Number of cells ↓ Size ↓ <b>AC21</b>	Type	Design				Switch pro-	Escutcheon plate		
					E.	Z.	V.	SMA. P.				
<b>Star-Delta switches SD</b>												
1 rotary direction 		60°	4	48 □ 20A	<b>M10H</b> .	x	x	x	x	x <sup>1)</sup>	. SD	
				32A	<b>M20</b> .	x	x	x	x	-	. SD	
				64 □ 32A	<b>N20</b> .	x	-	x	-	x	. SD	
				50A	<b>N33F</b> .	x	-	x	-	x	. SD	
				88 □ 63A	<b>N40</b> .	x	-	x	-	x	. SD	
90A	<b>N61</b> .	x	-	x	-	x	. SD					
	115A	<b>N80</b> .	x	-	x	-	. SD					
	132 □ 150A	<b>N100</b> .	x	-	x	-	. SD					
250A	<b>N200</b> .	x	-	x	-	. SD						
both rotary directions 		45°	5	48 □ 20A	<b>M10H</b> .	x	x	x	x	x <sup>1)</sup>	. SDR	
				32A	<b>M20</b> .	x	x	x	x	-	. SDR	
				64 □ 32A	<b>N20</b> .	x	-	x	-	x	. SDR	
				50A	<b>N33F</b> .	x	-	x	-	x	. SDR	
				88 □ 63A	<b>N40</b> .	x	-	x	-	x	. SDR	
90A	<b>N61</b> .	x	-	x	-	x	. SDR					
	115A	<b>N80</b> .	x	-	x	-	. SDR					
	132 □ 150A	<b>N100</b> .	x	-	x	-	. SDR					
250A	<b>N200</b> .	x	-	x	-	. SDR						
1 rotary direction spring return from Y to off 		30°+60°	4	48 □ 20A	<b>M10H</b> .	x	x	x	x	x <sup>1)</sup>	. SRD	
				32A	<b>M20</b> .	x	x	x	x	-	. SRD	
				64 □ 32A	<b>N20</b> .	x	-	x	-	x	. SRD	
				50A	<b>N33F</b> .	x	-	x	-	x	. SRD	
				88 □ 63A	<b>N40</b> .	x	-	x	-	x	. SRD	
90A	<b>N60</b> .	x	-	x	-	x	. SRD					
	115A	<b>N80</b> .	x	-	x	-	. SRD					
	132 □ 150A	<b>N100</b> .	x	-	x	-	. SRD					
250A	<b>N200</b> .	x	-	x	-	. SRD						
Star-Delta selector switch 		60°	4	48 □ 20A	<b>M10H</b> .	x	x	x	x	x <sup>1)</sup>	. SDU	
				32A	<b>M20</b> .	x	x	x	x	-	. SDU	
				64 □ 32A	<b>N20</b> .	x	-	x	-	x	. SDU	
				50A	<b>N33F</b> .	x	-	x	-	x	. SDU	
				88 □ 63A	<b>N40</b> .	x	-	x	-	x	. SDU	
90A	<b>N60</b> .	x	-	x	-	x	. SDU					
	115A	<b>N80</b> .	x	-	x	-	. SDU					
	132 □ 150A	<b>N100</b> .	x	-	x	-	. SDU					
250A	<b>N200</b> .	x	-	x	-	. SDU						

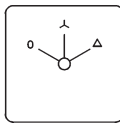
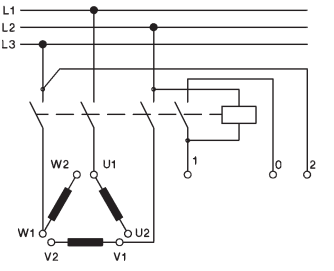
**Ordering example:** AC21 32A plastic enclosed, star-delta selector switch

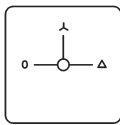
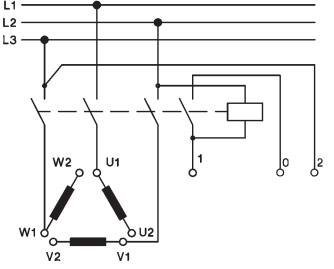
**N20 P SDU**

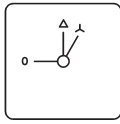
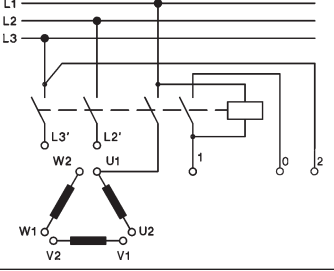
1) Plastic enclosed switches are delivered with switch type M10.

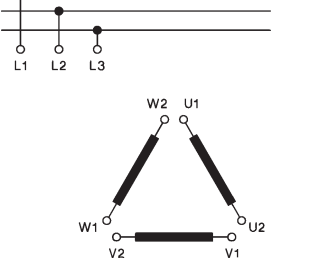
## Switching programs

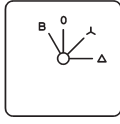
Description	Wiring diagram	Switching angle	Number of cells ↓ Size ↓ AC21	Type	Design				Switch pro-	Escutcheon plate			
					E.	Z.	V.	SMA. P.					
with double outfeed phases for use with manual motor starter  		60°	4	48 □ 20A 32A	M10H .	x	x	x	x	x <sup>1)</sup> -	. SDMO		
				64 □ 32A 50A	N20 .	x	x	x	x	- -	. SDMO		
				88 □ 63A 90A 115A	N40 .	x	-	x	-	x	x		. SDMO
					N61 .	x	-	x	-	x	-		. SDMO
					N80 .	x	-	x	-	-	-		. SDMO
with auxiliary contacts for contactor control, without main contacts, automatic zero setting in event of mains break-down  		90°	4	48 □ 20A 32A	M10H .	x	x	x	x	x <sup>1)</sup> -	. SDJ1		
				64 □ 32A 50A	N20 .	x	-	x	-	x	x		. SDJ1
				88 □ 63A 90A 115A	N40 .	x	-	x	-	x	-		. SDJ1
					N61 .	x	-	x	-	x	-		. SDJ1
					N80 .	x	-	x	-	-	-		. SDJ1
with auxiliary contacts for contactor control, without main contacts, automatic zero setting in event of mains break-down, spring return to  		90°+30°	4	48 □ 20A 32A	M10H .	x	x	x	x	x <sup>1)</sup> -	. SDJ2		
				64 □ 32A 50A	N20 .	x	-	x	-	x	x		. SDJ2
				88 □ 63A 90A 115A	N40 .	x	-	x	-	x	-		. SDJ2
					N61 .	x	-	x	-	x	-		. SDJ2
					N80 .	x	-	x	-	-	-		. SDJ2
as type SDJ1 but for both rotary directions  		60°	7	48 □ 20A 32A	M10H .	x	x	x	-	- -	. SDRJ1		
				64 □ 32A 50A	N20 .	x	-	x	-	x	x		. SDRJ1
				88 □ 63A 90A 115A	N40 .	x	-	x	-	x	-		. SDRJ1
					N61 .	x	-	x	-	-	-		. SDRJ1
					N80 .	x	-	x	-	-	-		. SDRJ1
with brake position (counter current braking) brake position is a momentary operation  		45°+30°	5	48 □ 20A 32A	M10H .	x	x	x	x	x <sup>1)</sup> -	. SDB		
				64 □ 32A 50A	N20 .	x	-	x	-	x	x		. SDB
				88 □ 63A 90A 115A	N40 .	x	-	x	-	x	-		. SDB
					N61 .	x	-	x	-	x	-		. SDB
					N80 .	x	-	x	-	-	-		. SDB
		N100 .	x	-	x	-	-	-	. SDB				
		N200 .	x	-	x	-	-	-	. SDB				

Ordering example: AC21 250A panel mounting star-delta switch with brake position

N200 E SDB

1) Plastic enclosed switches are delivered with switch type M10.

## Switching programs

Description	Wiring diagram	Switching angle	Number of cells ↓ Size ↓ <b>AC21</b>	Type	Design				Switch pro-	Escutcheon plate			
					E.	Z.	V.	SMA. P.					
for starting up single-phase motors with split-phase, spring return from START to Off		30°+60°	2	48 □ 20A 32A	<b>M10H</b> . x x x x x <sup>1)</sup> - . <b>HP1</b> <b>M20</b> . x x x x - - . <b>HP1</b>	x	x	x	x	x <sup>1)</sup>	-		
			64 □ 32A 50A	<b>N20</b> . x - x - x x . <b>HP1</b> <b>N33F</b> . x - x - x - . <b>HP1</b>	x	-	x	-	x	x	.		<b>HP1</b>
			88 □ 63A	<b>N40</b> . x - x - x - . <b>HP1</b>	x	-	x	-	x	-	.		<b>HP1</b>
for starting up single-phase motors with split-phase, spring return from START to 1		90°+30°	2	48 □ 20A 32A	<b>M10H</b> . x x x x x <sup>1)</sup> - . <b>HP2</b> <b>M20</b> . x x x x - - . <b>HP2</b>	x	x	x	x	x <sup>1)</sup>	-		
			64 □ 32A 50A	<b>N20</b> . x - x - x x . <b>HP2</b> <b>N33F</b> . x - x - x - . <b>HP2</b>	x	-	x	-	x	x	.		<b>HP2</b>
			88 □ 63A	<b>N40</b> . x - x - x - . <b>HP2</b>	x	-	x	-	x	-	.		<b>HP2</b>
for starting up single-phase motors with split-phase, both rotary directions		60°+30°	3	48 □ 20A 32A	<b>M10H</b> . x x x x x <sup>1)</sup> - . <b>HPR1</b> <b>M20</b> . x x x x - - . <b>HPR1</b>	x	x	x	x	x <sup>1)</sup>	-		
			64 □ 32A 50A	<b>N20</b> . x - x - x x . <b>HPR1</b> <b>N33F</b> . x - x - x - . <b>HPR1</b>	x	-	x	-	x	x	.		<b>HPR1</b>
			88 □ 63A	<b>N40</b> . x - x - x - . <b>HPR1</b>	x	-	x	-	x	-	.		<b>HPR1</b>
as type HPR1 with starting and phase-shifting capacitor		60°+30°	4	48 □ 20A 32A	<b>M10H</b> . x x x x x <sup>1)</sup> - . <b>HPR2</b> <b>M20</b> . x x x x - - . <b>HPR2</b>	x	x	x	x	x <sup>1)</sup>	-		
			64 □ 32A 50A	<b>N20</b> . x - x - x x . <b>HPR2</b> <b>N33F</b> . x - x - x - . <b>HPR2</b>	x	-	x	-	x	x	.		<b>HPR2</b>
			88 □ 63A	<b>N40</b> . x - x - x - . <b>HPR2</b>	x	-	x	-	x	-	.		<b>HPR2</b>

**Ordering example:** AC21 63A panel mounting, split phase switch, both rotary directions **N40 E HPR1**

1) Plastic enclosed switches are delivered with switch type M10.

## Switching programs

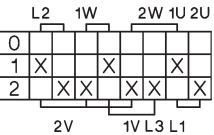
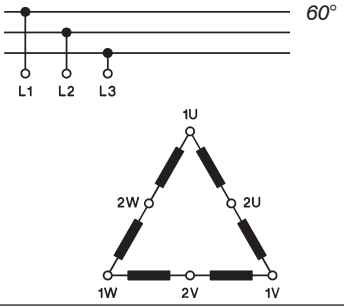
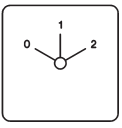
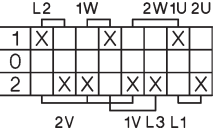
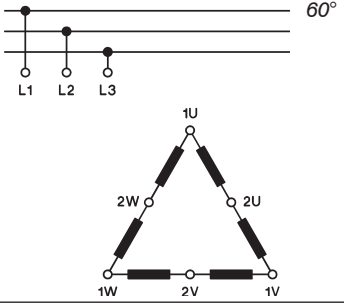
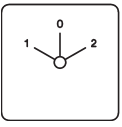
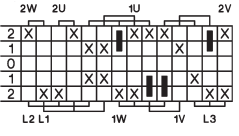
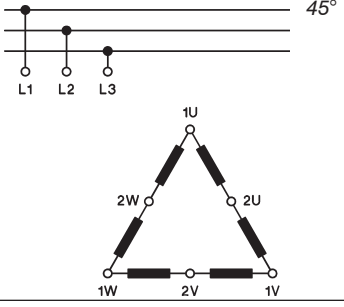
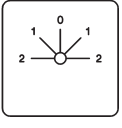
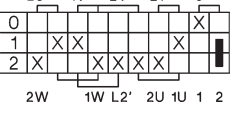
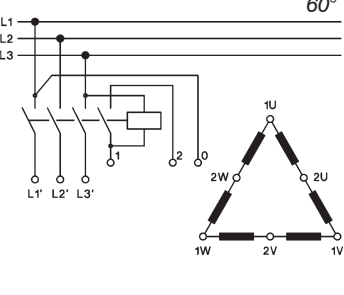
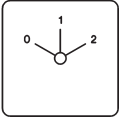
Description	Wiring diagram	Switching angle	Number of cells		Type	Design				Switch pro-	Escutcheon plate				
			↓ Size	↓ AC21		E.	Z.	V.	SMA.			P.			
1 Dahlander winding 1 rotary direction  		60°	4	48 □	20A 32A	M10H .	x	x	x	x	x <sup>1)</sup> -	. P61			
				64 □	32A 50A	N20 .	x	-	x	-	x	x		-	. P61
				88 □	63A 90A 115A	N40 .	x	-	x	-	x	-		-	. P61
						N61 .	x	-	x	-	x	-		-	. P61
						N80 .	x	-	x	-	-	-		-	. P61
1 Dahlander winding 1 rotary direction  		60°	4	48 □	20A 32A	M10H .	x	x	x	x	x <sup>1)</sup> -	. P62			
				64 □	32A 50A	N20 .	x	-	x	-	x	x		-	. P62
				88 □	63A 90A 115A	N40 .	x	-	x	-	x	-		-	. P62
						N61 .	x	-	x	-	x	-		-	. P62
						N80 .	x	-	x	-	-	-		-	. P62
1 Dahlander winding both rotary directions  		45°	7	48 □	20A 32A	M10H .	x	x	x	-	-	. P61R			
				64 □	32A 50A	N20 .	x	-	x	-	x	-		-	. P61R
				88 □	63A 90A 115A	N40 .	x	-	x	-	x	-		-	. P61R
						N61 .	x	-	x	-	-	-		-	. P61R
						N80 .	x	-	x	-	-	-		-	. P61R
1 Dahlander winding 1 rotary direction, with auxiliary contacts for contactor control  		60°	5	48 □	20A 32A	M10H .	x	x	x	x	x <sup>1)</sup> -	. P61J			
				64 □	32A 50A	N20 .	x	-	x	-	x	x		-	. P61J
				88 □	63A 90A 115A	N40 .	x	-	x	-	x	-		-	. P61J
						N61 .	x	-	x	-	x	-		-	. P61J
						N80 .	x	-	x	-	-	-		-	. P61J
		N100 .	x	-	x	-	-	-	-	. P61J					
		N200 .	x	-	x	-	-	-	-	. P61J					

Ordering example: AC21 32A cast enclosed, multi speed switch, 1 Dahlander winding, 1 rotary direction

N20 G P61

1) Plastic enclosed switches are delivered with switch type M10.

## Switching programs

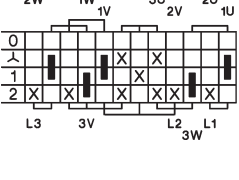
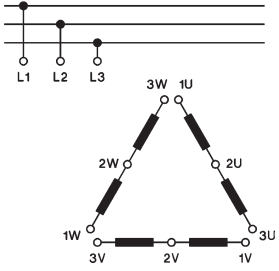
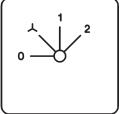
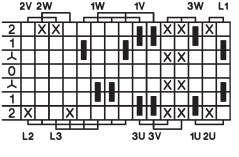
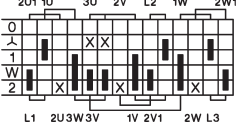
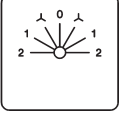
Description	Wiring diagram	Switching angle	Number of cells ↓ Size ↓ <b>AC21</b>	Type	Design				Switch pro-	Escutcheon plate			
					E.	Z.	V.	SMA. P.					
<b>Multi speed switches P</b>													
open Dahlander winding 1 rotary direction low speed with star-delta-start 		45°	6	48 □ 20A 32A	M10H .	x	x	x	-	x <sup>1)</sup> -	. P91		
					M20 .	x	x	x	-	-	-	. P91	
					64 □ 32A 50A	N20 .	x	-	x	-	x	x	. P91
					N33F .	x	-	x	-	x	-	. P91	
					88 □ 63A 90A 115A	N40 .	x	-	x	-	x	-	. P91
N61 .	x	-	x	-	x	-	. P91						
N80 .	x	-	x	-	-	-	. P91						
132 □ 150A 250A	N100 .	x	-	x	-	-	-	. P91					
N200 .	x	-	x	-	-	-	. P91						
open Dahlander winding both rotary directions low speed with star-delta-start 		30°	8	48 □ 20A 32A	M10H .	x	x	x	-	-	. P91R		
					M20 .	x	x	x	-	-	-	. P91R	
					64 □ 32A 50A	N20 .	x	-	x	-	x	-	. P91R
					N33F .	x	-	x	-	-	-	. P91R	
					88 □ 63A 90A 115A	N40 .	x	-	x	-	x	-	. P91R
N61 .	x	-	x	-	-	-	. P91R						
N80 .	x	-	x	-	-	-	. P91R						
132 □ 150A 250A	N100 .	x	-	x	-	-	-	. P91R					
N200 .	x	-	x	-	-	-	. P91R						
open Dahlander winding 1 rotary direction, low speed with star-delta-start, with additional start position (starting resistor) 		30°	7	48 □ 20A 32A	M10H .	x	x	x	-	-	. P91W		
					M20 .	x	x	x	-	-	-	. P91W	
					64 □ 32A 50A	N20 .	x	-	x	-	x	-	. P91W
					N33F .	x	-	x	-	-	-	. P91W	
					88 □ 63A 90A 115A	N40 .	x	-	x	-	x	-	. P91W
N61 .	x	-	x	-	-	-	. P91W						
N80 .	x	-	x	-	-	-	. P91W						
132 □ 150A 250A	N100 .	x	-	x	-	-	-	. P91W					
N200 .	x	-	x	-	-	-	. P91W						

**Ordering example:** AC21 250A panel mounting, multi speed switch, 1 rotary direction, low speed with star-delta-start

**N200 E P91**

1) Plastic enclosed switches are delivered with switch type M10.

## Switching programs

Description	Wiring diagram	Switching angle	Number of cells		Type	Design				Switch pro-	Escutcheon plate
			↓ Size	↓ AC21		E.	Z.	V.	SMA.		
2 separate windings 1 rotary direction		60°	3	48 □ 20A 32A	M10H . x x x x x <sup>1)</sup> - . P63 M20 . x x x x - - . P63						
				64 □ 32A 50A	N20 . x - x - x x . P63 N33F . x - x - x - . P63						
				88 □ 63A 90A 115A	N40 . x - x - x - . P63 N61 . x - x - x - . P63 N80 . x - x - - - . P63						
				132 □ 150A 250A	N100 . x - x - - - . P63 N200 . x - x - - - . P63						
2 separate windings 1 rotary direction		60°	3	48 □ 20A 32A	M10H . x x x x x <sup>1)</sup> - . P64 M20 . x x x x - - . P64						
				64 □ 32A 50A	N20 . x - x - x x . P64 N33F . x - x - x - . P64						
				88 □ 63A 90A 115A	N40 . x - x - x - . P64 N61 . x - x - x - . P64 N80 . x - x - - - . P64						
				132 □ 150A 250A	N100 . x - x - - - . P64 N200 . x - x - - - . P64						
2 separate windings both rotary directions		60°	5	48 □ 20A 32A	M10H . x x x x x <sup>1)</sup> - . P66 M20 . x x x x - - . P66						
				64 □ 32A 50A	N20 . x - x - x x . P66 N33F . x - x - x - . P66						
				88 □ 63A 90A 115A	N40 . x - x - x - . P66 N61 . x - x - x - . P66 N80 . x - x - - - . P66						
				132 □ 150A 250A	N100 . x - x - - - . P66 N200 . x - x - - - . P66						
2 separate windings 1 opened 1 rotary direction		60°	4	48 □ 20A 32A	M10H . x x x x x <sup>1)</sup> - . P71 M20 . x x x x - - . P71						
				64 □ 32A 50A	N20 . x - x - x x . P71 N33F . x - x - x - . P71						
				88 □ 63A 90A 115A	N40 . x - x - x - . P71 N61 . x - x - x - . P71 N80 . x - x - - - . P71						
				132 □ 150A 250A	N100 . x - x - - - . P71 N200 . x - x - - - . P71						
2 separate windings 1 rotary direction low speed with star-delta-start		45°	6	48 □ 20A 32A	M10H . x x x - x <sup>1)</sup> - . P96 M20 . x x x - - - . P96						
				64 □ 32A 50A	N20 . x - x - x x . P96 N33F . x - x - x - . P96						
				88 □ 63A 90A 115A	N40 . x - x - x - . P96 N61 . x - x - x - . P96 N80 . x - x - - - . P96						
				132 □ 150A 250A	N100 . x - x - - - . P96 N200 . x - x - - - . P96						

**Ordering example:** AC21 250A panel mounting, multi speed switch, 2 separate windings, low speed with star-delta-start **N200 E P96**

1) Plastic enclosed switches are delivered with switch type M10.

## Switching programs

Description	Wiring diagram	Switching angle	Number of cells ↓ Size ↓ <b>AC21</b>	Type	Design				Switch pro-	Escutcheon plate				
					E.	Z.	V.	SMA. P.						
<b>Multi speed switches P</b>														
2 separate windings 1 rotary direction both speeds with star-delta-start		45°	8	48 □	20A	<b>M10H</b>	x	x	x	-	-	-	. P122	
					32A	<b>M20</b>	x	x	x	-	-	-	. P122	
			64	□	32A	<b>N20</b>	x	-	x	-	x	-	. P122	
					50A	<b>N33F</b>	x	-	x	-	-	-	. P122	
		45°	88	□	63A	<b>N40</b>	x	-	x	-	x	-	. P122	
					90A	<b>N61</b>	x	-	x	-	-	-	. P122	
					115A	<b>N80</b>	x	-	x	-	-	-	. P122	
			132	□	150A	<b>N100</b>	x	-	x	-	-	-	. P122	
				250A	<b>N200</b>	x	-	x	-	-	. P122			
1 Dahlander winding A 1 normal winding B 3 speeds 1 rotary direction <b>0-AΔ-BΔ or Δ-AΔ</b>		45°	6	48 □	20A	<b>M10H</b>	x	x	x	-	x <sup>1)</sup>	-	. P93	
					32A	<b>M20</b>	x	x	x	-	-	-	. P93	
			64	□	32A	<b>N20</b>	x	-	x	-	x	x	. P93	
					50A	<b>N33F</b>	x	-	x	-	x	-	. P93	
		45°	88	□	63A	<b>N40</b>	x	-	x	-	x	-	. P93	+127
					90A	<b>N61</b>	x	-	x	-	x	-	. P93	
					115A	<b>N80</b>	x	-	x	-	-	-	. P93	
			132	□	150A	<b>N100</b>	x	-	x	-	-	-	. P93	
				250A	<b>N200</b>	x	-	x	-	-	. P93			
1 Dahlander winding A 1 normal winding B 3 speeds 1 rotary direction <b>0-BΔ or Δ-AΔ-AΔ</b>		45°	6	48 □	20A	<b>M10H</b>	x	x	x	-	x <sup>1)</sup>	-	. P94	
					32A	<b>M20</b>	x	x	x	-	-	-	. P94	
			64	□	32A	<b>N20</b>	x	-	x	-	x	-	. P94	
					50A	<b>N33F</b>	x	-	x	-	x	-	. P94	
		45°	88	□	63A	<b>N40</b>	x	-	x	-	x	-	. P94	+127
					90A	<b>N61</b>	x	-	x	-	x	-	. P94	
					115A	<b>N80</b>	x	-	x	-	-	-	. P94	
			132	□	150A	<b>N100</b>	x	-	x	-	-	-	. P94	
				250A	<b>N200</b>	x	-	x	-	-	. P94			
1 Dahlander winding A 1 normal winding B 3 speeds 1 rotary direction <b>0-AΔ-AΔ-BΔ or Δ</b>		45°	6	48 □	20A	<b>M10H</b>	x	x	x	-	x <sup>1)</sup>	-	. P95	
					32A	<b>M20</b>	x	x	x	-	-	-	. P95	
			64	□	32A	<b>N20</b>	x	-	x	-	x	x	. P95	
					50A	<b>N33F</b>	x	-	x	-	x	-	. P95	
		45°	88	□	63A	<b>N40</b>	x	-	x	-	x	-	. P95	+127
					90A	<b>N61</b>	x	-	x	-	x	-	. P95	
					115A	<b>N80</b>	x	-	x	-	-	-	. P95	
			132	□	150A	<b>N100</b>	x	-	x	-	-	-	. P95	
				250A	<b>N200</b>	x	-	x	-	-	. P95			
1 Dahlander winding A 1 normal winding B 3 speeds both rotary directions		45°	9	48 □	20A	<b>M10H</b>	x	x	x	-	-	-	. P93R	
					32A	<b>M20</b>	x	x	x	-	-	-	. P93R	
			64	□	32A	<b>N20</b>	x	-	x	-	-	-	. P93R	
					50A	<b>N33F</b>	x	-	x	-	-	-	. P93R	
		45°	88	□	63A	<b>N40</b>	x	-	x	-	-	-	. P93R	
					90A	<b>N61</b>	x	-	x	-	-	-	. P93R	
					115A	<b>N80</b>	x	-	x	-	-	-	. P93R	
			132	□	150A	<b>N100</b>	x	-	x	-	-	-	. P93R	
				250A	<b>N200</b>	x	-	x	-	-	. P93R			

**Ordering example:** AC21 250A panel mounting, multi speed switch, 1 Dahlander winding A,  
1 normal winding B, 3 speeds, both rotary directions **N200 E P93R**

1) Plastic enclosed switches are delivered with switch type M10.

## Switching programs

Description	Wiring diagram	Switching angle	Number of cells		Type	Design				Switch pro-	Escutcheon plate				
			↓ Size	↓ AC21		E.	Z.	V.	SMA.			P.			
<b>Multi speed switches P</b> 1 Dahlander winding A 1 normal winding B 3 speeds both rotary directions		45°	9	48 □ 20A	<b>M10H</b> .	x	x	x	-	-	-	. <b>P94R</b>			
							<b>M20</b> .	x	x	x	-	-		-	. <b>P94R</b>
1 Dahlander winding A 1 normal winding B 3 speeds both rotary directions		45°	8	48 □ 20A	<b>M10H</b> .	x	x	x	-	-	-	. <b>P95R</b>			
							<b>M20</b> .	x	x	x	-	-		-	. <b>P95R</b>
2 Dahlander windings 4 speeds 1 rotary direction <b>0-AΔ-BΔ-AΔ-BΔ</b>		30°	8	48 □ 20A	<b>M10H</b> .	x	x	x	-	-	-	. <b>P124</b>			
							<b>M20</b> .	x	x	x	-	-		-	. <b>P124</b>
2 Dahlander windings 4 speeds both rotary directions		30°	12	48 □ 20A	<b>M10H</b> .	x	x	x	-	-	-	. <b>P124R</b>			
							<b>M20</b> .	x	x	x	-	-		-	. <b>P124R</b>

Ordering example: AC21 250A Base mounting, multi speed switch, 2 Dahlander windings, 4 speeds, 1 rotary direction

**N200 V P124**

## Switching programs

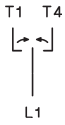
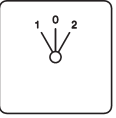
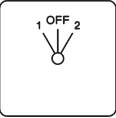
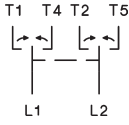
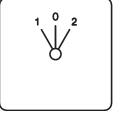
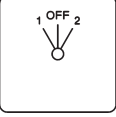
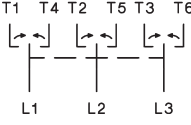
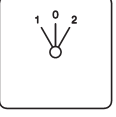
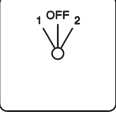
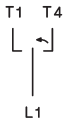
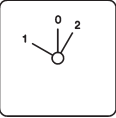
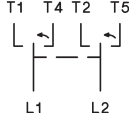
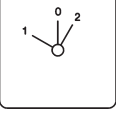
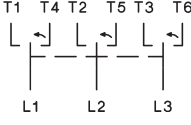
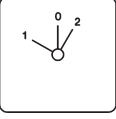
Description	Wiring diagram	Switching angle	Number of cells ↓ Size ↓ AC21	Type	Design				Switch pro-	Escutcheon plate
					E.	Z.	V.	SMA.		
<b>Changeover switches with spring return to off UR</b>										
1-pole		30°	1	48 □ 20A 32A	M10H . x x x x x <sup>1)</sup> - . UR1 M20 . x x x x - - . UR1					 +264 
				64 □ 32A 50A	N20 . x - x - x x . UR1 N33F . x - x - x - . UR1					
				88 □ 63A	N40 . x - x - x - . UR1					
2-pole		30°	2	48 □ 20A 32A	M10H . x x x x x <sup>1)</sup> - . UR2 M20 . x x x x - - . UR2					 +264 
				64 □ 32A 50A	N20 . x - x - x x . UR2 N33F . x - x - x - . UR2					
				88 □ 63A	N40 . x - x - x - . UR2					
3-pole		30°	3	48 □ 20A 32A	M10H . x x x x x <sup>1)</sup> - . UR3 M20 . x x x x - - . UR3					 +264 
				64 □ 32A 50A	N20 . x - x - x x . UR3 N33F . x - x - x - . UR3					
				88 □ 63A	N40 . x - x - x - . UR3					
<b>Changeover switches with 1 latched and 1 momentary position UK</b>										
1-pole position 1 latched position 2 with spring return		60°+30°	1	48 □ 20A 32A	M10H . x x x x x <sup>1)</sup> - . UK1 M20 . x x x x - - . UK1					
				64 □ 32A 50A	N20 . x - x - x x . UK1 N33F . x - x - x - . UK1					
				88 □ 63A	N40 . x - x - x - . UK1					
2-pole position 1 latched position 2 with spring return		60°+30°	2	48 □ 20A 32A	M10H . x x x x x <sup>1)</sup> - . UK2 M20 . x x x x - - . UK2					
				64 □ 32A 50A	N20 . x - x - x x . UK2 N33F . x - x - x - . UK2					
				88 □ 63A	N40 . x - x - x - . UK2					
3-pole position 1 latched position 2 with spring return		60°+30°	3	48 □ 20A 32A	M10H . x x x x x <sup>1)</sup> - . UK3 M20 . x x x x - - . UK3					
				64 □ 32A 50A	N20 . x - x - x x . UK3 N33F . x - x - x - . UK3					
				88 □ 63A	N40 . x - x - x - . UK3					

**Ordering example:** AC21 63A panel mounting, changeover switch, position 1 latched, position 2 with spring return, 3-pole: **N40 E UK3**

1) Plastic enclosed switches are delivered with switch type M10.

## Switching programs

Description	Wiring diagram	Switching angle	Number of cells ↓ Size ↓ AC21	Type	Design				Switch pro-	Escutcheon plate
					E.	Z.	V.	SMA. P.		
Double throw switches with spring return to off WR										
1-pole		30°	1	48 □ 20A 32A	M10H . x x x x x <sup>1)</sup> - . W1R M20 . x x x x - - . W1R					
				64 □ 32A 50A	N20 . x - x - x x . W1R N33F . x - x - x - . W1R					
				88 □ 63A	N40 . x - x - x - . W1R					
2-pole		30°	2	48 □ 20A 32A	M10H . x x x x x <sup>1)</sup> - . W2R M20 . x x x x - - . W2R					
				64 □ 32A 50A	N20 . x - x - x x . W2R N33F . x - x - x - . W2R					
				88 □ 63A	N40 . x - x - x - . W2R					
3-pole		30°	3	48 □ 20A 32A	M10H . x x x x x <sup>1)</sup> - . W3R M20 . x x x x - - . W3R					
				64 □ 32A 50A	N20 . x - x - x x . W3R N33F . x - x - x - . W3R					
				88 □ 63A	N40 . x - x - x - . W3R					

## Start-Stop switches S

Start-switch, 1-pole		30°	1	48 □ 20A 32A	M10H . x x x x x <sup>1)</sup> - . SE M20 . x x x x - - . SE					
				64 □ 32A 50A	N20 . x - x - x x . SE N33F . x - x - x - . SE					
Start-switch, 2-pole		30°	1	48 □ 20A 32A	M10H . x x x x x <sup>1)</sup> - . S2E M20 . x x x x - - . S2E					
				64 □ 32A 50A	N20 . x - x - x x . S2E N33F . x - x - x - . S2E					
Start-switch, 3-pole		30°	2	48 □ 20A 32A	M10H . x x x x x <sup>1)</sup> - . S3E M20 . x x x x - - . S3E					
				64 □ 32A 50A	N20 . x - x - x x . S3E N33F . x - x - x - . S3E					

**Bestellbeispiel:** AC21 50A base mounting, Start-switch, 3-pole

**N33F V S3E**

1) Plastic enclosed switches are delivered with switch type M10.

## Switching programs



Description	Wiring diagram	Switching angle	Number of cells ↓ Size ↓ AC21	Type	Design				Switch pro-	Escutcheon plate
					E.	Z.	V.	SMA. P.		
<b>Start-Stop switches S</b>										
Stop-switch, 1-pole		30°	1 48 □ 20A	M10H . x x x x x <sup>1)</sup> - . SA	x	x	x	x	x <sup>1)</sup> -	. SA
			64 □ 32A	M20 . x x x x - - . SA	x	x	x	x	- -	. SA
			50A	N20 . x - x - x x . SA	x	-	x	-	x	x
88 □ 63A	N33F . x - x - x - . SA	x	-	x	-	x	-	. SA		
Stop-switch, 2-pole		30°	1 48 □ 20A	M10H . x x x x x <sup>1)</sup> - . S2A	x	x	x	x	x <sup>1)</sup> -	. S2A
			64 □ 32A	M20 . x x x x - - . S2A	x	x	x	x	- -	. S2A
			50A	N20 . x - x - x x . S2A	x	-	x	-	x	x
88 □ 63A	N33F . x - x - x - . S2A	x	-	x	-	x	-	. S2A		
Stop-switch, 3-pole		30°	2 48 □ 20A	M10H . x x x x x <sup>1)</sup> - . S3A	x	x	x	x	x <sup>1)</sup> -	. S3A
			64 □ 32A	M20 . x x x x - - . S3A	x	x	x	x	- -	. S3A
			50A	N20 . x - x - x x . S3A	x	-	x	-	x	x
88 □ 63A	N33F . x - x - x - . S3A	x	-	x	-	x	-	. S3A		
Start-Stop-switch, 1-pole		30°	1 48 □ 20A	M10H . x x x x x <sup>1)</sup> - . SEA	x	x	x	x	x <sup>1)</sup> -	. SEA
			64 □ 32A	M20 . x x x x - - . SEA	x	x	x	x	- -	. SEA
			50A	N20 . x - x - x x . SEA	x	-	x	-	x	x
88 □ 63A	N33F . x - x - x - . SEA	x	-	x	-	x	-	. SEA		
Start-Stop-switch, 1-pole position START with spring return to 1		90° + 30°	1 48 □ 20A	M10H . x x x x x <sup>1)</sup> - . S392	x	x	x	x	x <sup>1)</sup> -	. S392
			64 □ 32A	M20 . x x x x - - . S392	x	x	x	x	- -	. S392
			50A	N20 . x - x - x x . S392	x	-	x	-	x	x
88 □ 63A	N33F . x - x - x - . S392	x	-	x	-	x	-	. S392		
Start-Stop-switch, 1-pole for reversing contactors		60° + 30°	2 48 □ 20A	M10H . x x x x x <sup>1)</sup> - . S2EA	x	x	x	x	x <sup>1)</sup> -	. S2EA
			64 □ 32A	M20 . x x x x - - . S2EA	x	x	x	x	- -	. S2EA
			50A	N20 . x - x - x x . S2EA	x	-	x	-	x	x
88 □ 63A	N33F . x - x - x - . S2EA	x	-	x	-	x	-	. S2EA		
Start-Stop-switch, 1-pole for reversing contactors with limit switches		30°	2 48 □ 20A	M10H . x x x x x <sup>1)</sup> - . S22	x	x	x	x	x <sup>1)</sup> -	. S22
			64 □ 32A	M20 . x x x x - - . S22	x	x	x	x	- -	. S22
			50A	N20 . x - x - x x . S22	x	-	x	-	x	x
88 □ 63A	N33F . x - x - x - . S22	x	-	x	-	x	-	. S22		

Ordering example: AC21 50A panel mounting, Start-Stop-switch, 1-pole for reversing contactors

N33F E S2EA

1) Plastic enclosed switches are delivered with switch type M10.

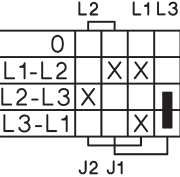
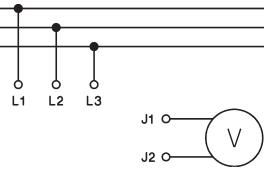
## Switching programs

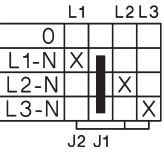
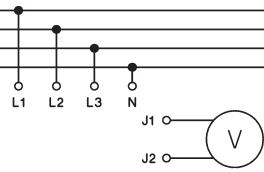
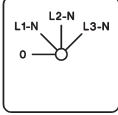
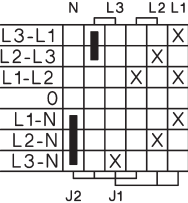
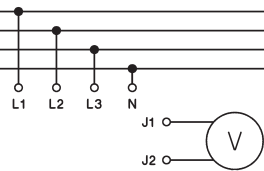
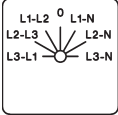
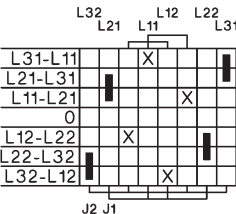
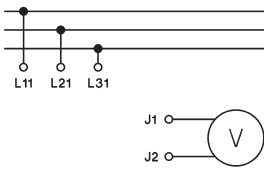
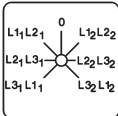
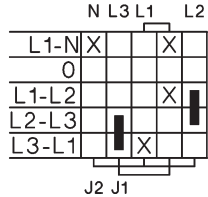
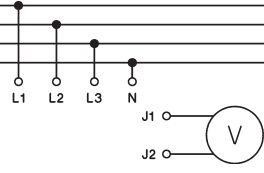
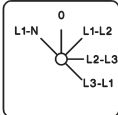
Description	Wiring diagram	Switching angle	Number of cells		Type	Design				Switch pro-	Escutcheon plate		
			↓ Size	↓ AC21		E.	Z.	V.	SMA.			P.	
<b>3 line voltages</b> 		45°	2	48 □ 20A	<b>M10H .</b>	x	x	x	x	x <sup>1)</sup>	-	. V3	
				64 □ 32A	<b>M20 .</b>	x	x	x	x	-	-	-	
				64 □ 32A	<b>N20 .</b>	x	-	x	-	x	x	. V3	
				50A	<b>N33F .</b>	x	x	x	-	x	-	. V3	
<b>3 phase voltages</b> 		45°	2	48 □ 20A	<b>M10H .</b>	x	x	x	x	x <sup>1)</sup>	-	. V0	
				64 □ 32A	<b>M20 .</b>	x	x	x	x	-	-	-	
				64 □ 32A	<b>N20 .</b>	x	-	x	-	x	x	. V0	
				50A	<b>N33F .</b>	x	x	x	-	x	-	. V0	
<b>3 line voltages and 3 phase voltages</b> 		30°	3	48 □ 20A	<b>M10H .</b>	x	x	x	x	x <sup>1)</sup>	-	. V1	
				64 □ 32A	<b>M20 .</b>	x	x	x	x	-	-	-	
				64 □ 32A	<b>N20 .</b>	x	-	x	-	x	x	. V1	
				50A	<b>N33F .</b>	x	x	x	-	x	-	. V1	
<b>2 3-phase systems 2 x 3 line voltages</b> 		45°	4	48 □ 20A	<b>M10H .</b>	x	x	x	x	x <sup>1)</sup>	-	. V32	
				64 □ 32A	<b>M20 .</b>	x	x	x	x	-	-	-	
				64 □ 32A	<b>N20 .</b>	x	-	x	-	x	x	. V32	
				50A	<b>N33F .</b>	x	-	x	-	x	-	. V32	
<b>3 line voltages and 1 phase voltage</b> 		45°	3	48 □ 20A	<b>M10H .</b>	x	x	x	x	x <sup>1)</sup>	-	. V13	
				64 □ 32A	<b>M20 .</b>	x	x	x	x	-	-	-	
				64 □ 32A	<b>N20 .</b>	x	-	x	-	x	x	. V13	
				50A	<b>N33F .</b>	x	x	x	-	x	-	. V13	

**Ordering example:** AC21 50A panel mounting, Voltmeter selector switch, 3 line voltages and 1 phase voltage

**N33F E V13**

1) Plastic enclosed switches are delivered with switch type M10.

## Switching programs

Description	Wiring diagram	Switching angle	Number of cells ↓ Size ↓ <b>AC21</b>	Type	Design				Switch pro-	Escutcheon plate			
					E.	Z.	V.	SMA.			P.		
<b>Ammeter selector switches M</b>													
1-pole, for current transformer		90°	1	48 □ 20A	<b>M10H</b> .	x	x	x	x	x <sup>1)</sup> -	. M11		
				64 □ 32A	<b>M20</b> .	x	x	x	x	- -	. M11		
				88 □ 63A	<b>N20</b> .	x	-	x	-	x	x		. M11
					<b>N33F</b> .	x	x	x	-	x	-	. M11	
2-pole, for 1 current transformer or direct current measurement		90°	2	48 □ 20A	<b>M10H</b> .	x	x	x	x	x <sup>1)</sup> -	. M12		
				64 □ 32A	<b>M20</b> .	x	x	x	x	- -	. M12		
				88 □ 63A	<b>N20</b> .	x	-	x	-	x	x		. M12
				90A	<b>N60</b> .	x	-	x	-	x	-		. M12
				115A	<b>N80</b> .	x	-	x	-	-	-		. M12
					<b>N100</b> .	x	-	x	-	-	-	. M12	
					<b>N200</b> .	x	-	x	-	-	-	. M12	
1-pole, for 2 current transformers		90°	2	48 □ 20A	<b>M10H</b> .	x	x	x	x	x <sup>1)</sup> -	. M21		
				64 □ 32A	<b>M20</b> .	x	x	x	x	- -	. M21		
				88 □ 63A	<b>N20</b> .	x	-	x	-	x	x		. M21
					<b>N33F</b> .	x	x	x	-	x	-	. M21	
2-pole, for 2 current transformers or direct current measurement in 2 phases		90°	3	48 □ 20A	<b>M10H</b> .	x	x	x	x	x <sup>1)</sup> -	. M22		
				64 □ 32A	<b>M20</b> .	x	x	x	x	- -	. M22		
				88 □ 63A	<b>N20</b> .	x	-	x	-	x	x		. M22
				90A	<b>N60</b> .	x	-	x	-	x	-		. M22
				115A	<b>N80</b> .	x	-	x	-	-	-		. M22
					<b>N100</b> .	x	-	x	-	-	-	. M22	
					<b>N200</b> .	x	-	x	-	-	-	. M22	
1-pole, for 3 current transformers		90°	3	48 □ 20A	<b>M10H</b> .	x	x	x	x	x <sup>1)</sup> -	. M31		
				64 □ 32A	<b>M20</b> .	x	x	x	x	- -	. M31		
				88 □ 63A	<b>N20</b> .	x	-	x	-	x	x		. M31
					<b>N33F</b> .	x	-	x	-	x	-	. M31	

Ordering example: AC21 63A panel mounting, ammeter selector switch, for 3 current transformers 1-pole

**N40 V M31**

1) Plastic enclosed switches are delivered with switch type M10.

## Switching programs

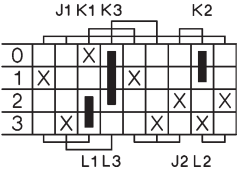
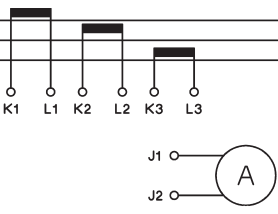
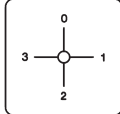
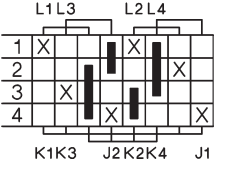
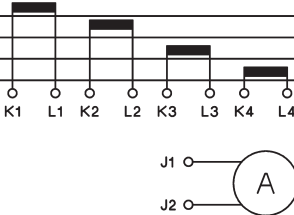
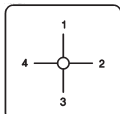
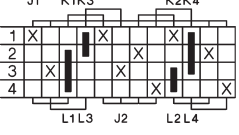
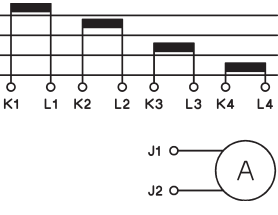
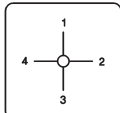
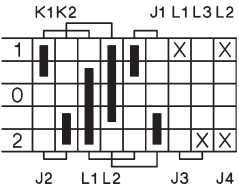
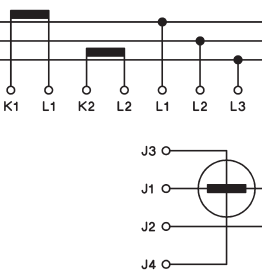
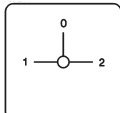



Description	Wiring diagram	Switching angle	Number of cells ↓ Size ↓ AC21	Type	Design				Switch pro-	Escutcheon plate			
					E.	Z.	V.	SMA. P.					
<b>2-pole, for 3 current transformers or direct current measurement in 3 phases</b> 		90°	6	48 □ 20A	M10H .	x	x	x	x	x <sup>1)</sup> -	. M32		
				32A	M20 .	x	x	x	-	-	-		. M32
				64 □ 32A	N20 .	x	-	x	-	x	x		. M32
				50A	N33F .	x	-	x	-	x	-		. M32
				88 □ 63A	N40 .	x	-	x	-	x	-		. M32
<b>1-pole, for 4 current transformers</b> 		90°	4	48 □ 20A	M10H .	x	x	x	x	x <sup>1)</sup> -	. M41		
				32A	M20 .	x	x	x	x	-	-		. M41
				64 □ 32A	N20 .	x	-	x	-	x	x		. M41
				50A	N33F .	x	-	x	-	x	-		. M41
				88 □ 63A	N40 .	x	-	x	-	x	-		. M41
<b>2-pole, for 4 current transformers or direct current measurement in 4 phases</b> 		90°	6	48 □ 20A	M10H .	x	x	x	x	x <sup>1)</sup> -	. M42		
				32A	M20 .	x	x	x	-	-	-		. M42
				64 □ 32A	N20 .	x	-	x	-	x	x		. M42
				50A	N33F .	x	-	x	-	x	-		. M42
				88 □ 63A	N40 .	x	-	x	-	x	-		. M42
<b>f. output measurement in 3-phase systems by 2-wattmeter method</b> 		90°	5	48 □ 20A	M10H .	x	x	x	x	x <sup>1)</sup> -	. M2W		
				32A	M20 .	x	x	x	x	-	-		. M2W
				64 □ 32A	N20 .	x	-	x	-	x	x		. M2W
				50A	N33F .	x	-	x	-	x	-		. M2W
				88 □ 63A	N40 .	x	-	x	-	x	-		. M2W
				90A	N61 .	x	-	x	-	x	-	. M2W	
				115A	N80 .	x	-	x	-	-	-	. M2W	
				132 □ 150A	N100 .	x	-	x	-	-	-	. M2W	
250A	N200 .	x	-	x	-	-	-	. M2W					

Ordering example: AC21 63A panel mounting, ammeter selector switch, for 4 current transformers 1-pole

N40 V M41

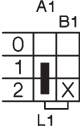
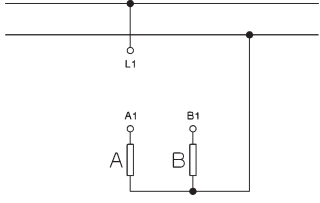
1) Plastic enclosed switches are delivered with switch type M10.

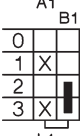
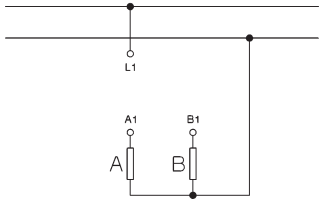
## Switching programs

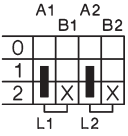
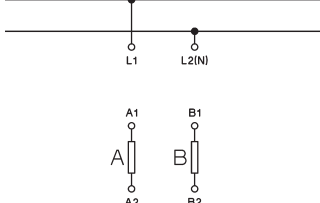
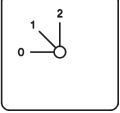
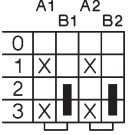
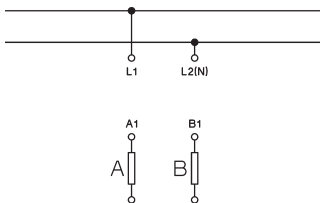
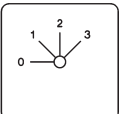
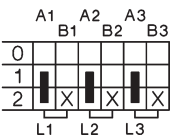
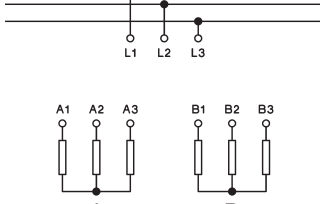
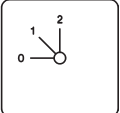
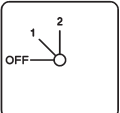
Description	Wiring diagram	Switching angle	Number of cells ↓ Size ↓ <b>AC21</b>	Type	Design				Switch pro-	Escutcheon plate						
					E.	Z.	V.	SMA.			P.					
<b>Gang switches GR</b>																
<b>2 circuits A and B</b> <b>1-pole</b> <b>0 - A - A+B</b>  		45°	1	48 □ 20A	M10H . x x x x x <sup>1)</sup> - . GR11	x	x	x	x	x <sup>1)</sup>	-	. GR11				
				64 □ 32A	M20 . x x x x - - . GR11	x	x	x	x	-	-	-		-	. GR11	
				88 □ 63A	N20 . x - x - x x . GR11	x	-	x	-	x	x	-		x	x	. GR11
				90A	N33F . x x x - x - . GR11	x	x	x	-	x	-	-		-	. GR11	
				115A	N40 . x - x - x - . GR11	x	-	x	-	x	-	-		-	. GR11	
<b>2 circuits A and B</b> <b>1-pole</b> <b>0 - A - B - A+B</b>  		45°	1	48 □ 20A	M10H . x x x x x <sup>1)</sup> - . GR12	x	x	x	x	x <sup>1)</sup>	-	. GR12				
				64 □ 32A	M20 . x x x x - - . GR12	x	x	x	x	-	-	-		-	. GR12	
				88 □ 63A	N20 . x - x - x x . GR12	x	-	x	-	x	x	-		x	x	. GR12
				90A	N33F . x x x - x - . GR12	x	x	x	-	x	-	-		-	. GR12	
				115A	N40 . x - x - x - . GR12	x	-	x	-	x	-	-		-	. GR12	
<b>2 circuits A and B</b> <b>2-pole</b> <b>0 - A - A+B</b>  		45°	2	48 □ 20A	M10H . x x x x x <sup>1)</sup> - . GR21	x	x	x	x	x <sup>1)</sup>	-	. GR21				
				64 □ 32A	M20 . x x x x - - . GR21	x	x	x	x	-	-	-		-	. GR21	
				88 □ 63A	N20 . x - x - x x . GR21	x	-	x	-	x	x	-		x	x	. GR21
				90A	N33F . x x x - x - . GR21	x	x	x	-	x	-	-		-	. GR21	
				115A	N40 . x - x - x - . GR21	x	-	x	-	x	-	-		-	. GR21	
<b>2 circuits A and B</b> <b>2-pole</b> <b>0 - A - B - A+B</b>  		45°	2	48 □ 20A	M10H . x x x x x <sup>1)</sup> - . GR22	x	x	x	x	x <sup>1)</sup>	-	. GR22				
				64 □ 32A	M20 . x x x x - - . GR22	x	x	x	x	-	-	-		-	. GR22	
				88 □ 63A	N20 . x - x - x x . GR22	x	-	x	-	x	x	-		x	x	. GR22
				90A	N33F . x x x - x - . GR22	x	x	x	-	x	-	-		-	. GR22	
				115A	N40 . x - x - x - . GR22	x	-	x	-	x	-	-		-	. GR22	
<b>2 circuits A and B</b> <b>3-pole</b> <b>0 - A - A+B</b>  		45°	3	48 □ 20A	M10H . x x x x x <sup>1)</sup> - . GR31	x	x	x	x	x <sup>1)</sup>	-	. GR31				
				64 □ 32A	M20 . x x x x - - . GR31	x	x	x	x	-	-	-		-	. GR31	
				88 □ 63A	N20 . x - x - x x . GR31	x	-	x	-	x	x	-		x	x	. GR31
				90A	N33F . x - x - x - . GR31	x	-	x	-	x	-	-		-	. GR31	
				115A	N40 . x - x - x - . GR31	x	-	x	-	x	-	-		-	. GR31	
<b>150A</b> <b>250A</b>	<b>N100 .</b> <b>N200 .</b>	<b>x - x - - - . GR31</b> <b>x - x - - - . GR31</b>	<b>- - - - - - . GR31</b> <b>- - - - - - . GR31</b>	<b>. GR31</b> <b>. GR31</b>	<b>- - - - - - . GR31</b> <b>- - - - - - . GR31</b>	<b>- - - - - - . GR31</b> <b>- - - - - - . GR31</b>	<b>- - - - - - . GR31</b> <b>- - - - - - . GR31</b>	<b>- - - - - - . GR31</b> <b>- - - - - - . GR31</b>	<b>- - - - - - . GR31</b> <b>- - - - - - . GR31</b>	<b>- - - - - - . GR31</b> <b>- - - - - - . GR31</b>	<b>. GR31</b> <b>. GR31</b>	<b>+126</b> 				

**Ordering example:** AC21 250A panel mounting, gang switch, 2 circuits A and B, 3-pole **N200 E GR31**

1) Plastic enclosed switches are delivered with switch type M10.

## Switching programs

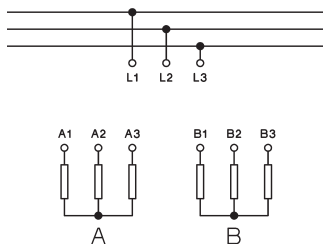
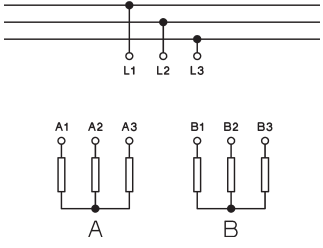
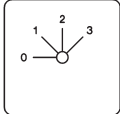
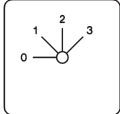
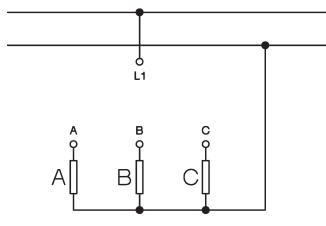
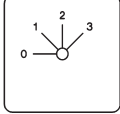
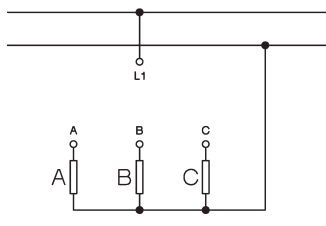
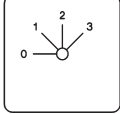
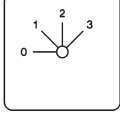
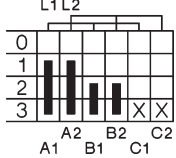
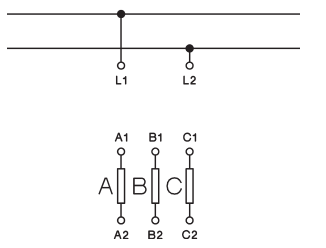
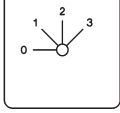
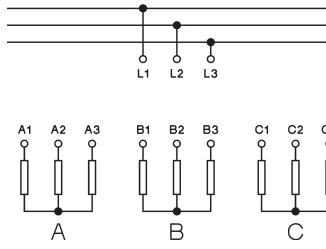
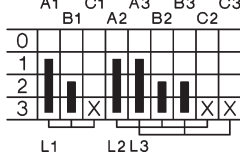
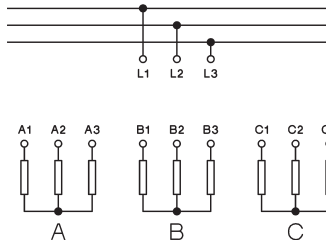
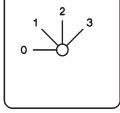
Description	Wiring diagram	Switching angle	Number of cells		Type	Design				Switch pro-	Escutcheon plate
			↓ Size	↓ AC21		E.	Z.	V.	SMA.		
<b>2 circuits A and B</b> <b>3-pole</b> <b>0 - A - B - A+B</b>    		45°	3	48 □ 20A 32A	M10H . x x x x x <sup>1)</sup> - . GR32 M20 . x x x x - - . GR32						
			64 □ 32A 50A	N20 . x - x - x x . GR32 N33F . x - x - x - . GR32							
			88 □ 63A 90A 115A	N40 . x - x - x - . GR32 N61 . x - x - x - . GR32 N80 . x - x - - - . GR32							
			132 □ 150A 250A	N100 . x - x - - - . GR32 N200 . x - x - - - . GR32							
<b>3 circuits A, B and C</b> <b>1-pole</b> <b>0 - A - A+B - A+B+C</b>    		45°	2	48 □ 20A 32A	M10H . x x x x x <sup>1)</sup> - . GR14 M20 . x x x x - - . GR14						
			64 □ 32A 50A	N20 . x - x - x x . GR14 N33F . x - x - x - . GR14							
			88 □ 63A 90A 115A	N40 . x - x - x - . GR14 N61 . x - x - x - . GR14 N80 . x - x - - - . GR14							
			132 □ 150A 250A	N100 . x - x - - - . GR14 N200 . x - x - - - . GR14							
<b>3 circuits A, B and C</b> <b>2-pole</b> <b>0 - A - A+B - A+B+C</b>    		45°	3	48 □ 20A 32A	M10H . x x x x x <sup>1)</sup> - . GR23 M20 . x x x x - - . GR23						
			64 □ 32A 50A	N20 . x - x - x x . GR23 N33F . x - x - x - . GR23							
			88 □ 63A 90A 115A	N40 . x - x - x - . GR23 N61 . x - x - x - . GR23 N80 . x - x - - - . GR23							
			132 □ 150A 250A	N100 . x - x - - - . GR23 N200 . x - x - - - . GR23							
<b>3 circuits A, B and C</b> <b>3-pole</b> <b>0 - A - A+B - A+B+C</b>    		45°	5	48 □ 20A 32A	M10H . x x x x x <sup>1)</sup> - . GR33 M20 . x x x x - - . GR33						
			64 □ 32A 50A	N20 . x - x - x x . GR33 N33F . x - x - x - . GR33							
			88 □ 63A 90A 115A	N40 . x - x - x - . GR33 N61 . x - x - x - . GR33 N80 . x - x - - - . GR33							
			132 □ 150A 250A	N100 . x - x - - - . GR33 N200 . x - x - - - . GR33							

Ordering example: AC21 250A panel mounting, gang switch, 3 circuits A, B and C, 3-pole

N200 E GR33

1) Plastic enclosed switches are delivered with switch type M10.

## Switching programs

Description	Wiring diagram	Switching angle	Number of cells ↓ Size ↓ <b>AC21</b>	Type	Design				Switch pro-	Escutcheon plate			
					E.	Z.	V.	SMA.			P.		
<b>Series-Parallel switches SP</b>													
<b>2 circuits A and B</b> <b>2-pole</b> <b>0 - A + B - A,B (parallel)</b>  		45°	2	48 □ 20A	<b>M10H</b> .	x	x	x	x	x <sup>1)</sup> -	. SP1		
				32A	<b>M20</b> .	x	x	x	x	-	-		. SP1
				64 □ 32A	<b>N20</b> .	x	-	x	-	x	x		. SP1
				50A	<b>N33F</b> .	x	x	x	-	x	-		. SP1
		90°	3	48 □ 20A	<b>M10H</b> .	x	x	x	x	x <sup>1)</sup> -	. SP4		
				32A	<b>M20</b> .	x	x	x	x	-	-		. SP4
				64 □ 32A	<b>N20</b> .	x	-	x	-	x	x		. SP4
				50A	<b>N33F</b> .	x	x	x	-	x	-		. SP4
		90°	3	88 □ 63A	<b>N40</b> .	x	-	x	-	x	-	. SP4	
				90A	<b>N61</b> .	x	-	x	-	x	-	. SP4	
				115A	<b>N80</b> .	x	-	x	-	-	-	. SP4	
				132 □ 150A	<b>N100</b> .	x	-	x	-	-	-	. SP4	
250A	<b>N200</b> .	x	-	x	-	-	-	. SP4					
<b>2 circuits A and B</b> <b>for 3-phase systems</b> <b>0 - A+B - A - B - A,B</b>  		30°	2	48 □ 20A	<b>M10H</b> .	x	x	x	x	x <sup>1)</sup> -	. SP3		
				32A	<b>M20</b> .	x	x	x	x	-	-		. SP3
				64 □ 32A	<b>N20</b> .	x	-	x	-	x	x		. SP3
				50A	<b>N33F</b> .	x	x	x	-	x	-		. SP3
		30°	2	88 □ 63A	<b>N40</b> .	x	-	x	-	x	-	. SP3	
				90A	<b>N61</b> .	x	-	x	-	x	-	. SP3	
				115A	<b>N80</b> .	x	-	x	-	-	-	. SP3	
				132 □ 150A	<b>N100</b> .	x	-	x	-	-	-	. SP3	
250A	<b>N200</b> .	x	-	x	-	-	-	. SP3					

**Ordering example:** AC21 250A panel mounting, series-parallel switch, 2 circuits for 3-phase systems

**N200 E SP3**

1) Plastic enclosed switches are delivered with switch type M10.

## Switching programs

Description	Wiring diagram	Switching angle	Number of cells ↓ Size ↓ AC21	Type	Design				Switch pro-	Escutcheon plate			
					E.	Z.	V.	SMA.			P.		
<b>Multi step switches 1-pole without Off ST.1</b>													
<b>3 steps</b>		60°	2	48 □ 20A	M10H .	x	x	x	x	x <sup>1)</sup> -	. ST31		
				32A	M20 .	x	x	x	x	- -	. ST31		
				64 □ 32A	N20 .	x	-	x	-	x	x		. ST31
				50A	N33F .	x	x	x	-	x	-		. ST31
				88 □ 63A	N40 .	x	-	x	-	x	-		. ST31
90A	N61 .	x	-	x	-	x	-	. ST31					
115A	N80 .	x	-	x	-	-	-	. ST31					
132 □ 150A	N100 .	x	-	x	-	-	-	. ST31					
250A	N200 .	x	-	x	-	-	-	. ST31					
<b>4 steps</b>		60°	2	48 □ 20A	M10H .	x	x	x	x	x <sup>1)</sup> -	. ST41		
				32A	M20 .	x	x	x	x	- -	. ST41		
				64 □ 32A	N20 .	x	-	x	-	x	x		. ST41
				50A	N33F .	x	x	x	-	x	-		. ST41
				88 □ 63A	N40 .	x	-	x	-	x	-		. ST41
90A	N61 .	x	-	x	-	x	-	. ST41					
115A	N80 .	x	-	x	-	-	-	. ST41					
132 □ 150A	N100 .	x	-	x	-	-	-	. ST41					
250A	N200 .	x	-	x	-	-	-	. ST41					
<b>5 steps</b>		60°	3	48 □ 20A	M10H .	x	x	x	x	x <sup>1)</sup> -	. ST51		
				32A	M20 .	x	x	x	x	- -	. ST51		
				64 □ 32A	N20 .	x	-	x	-	x	x		. ST51
				50A	N33F .	x	x	x	-	x	-		. ST51
				88 □ 63A	N40 .	x	-	x	-	x	-		. ST51
90A	N61 .	x	-	x	-	x	-	. ST51					
115A	N80 .	x	-	x	-	-	-	. ST51					
132 □ 150A	N100 .	x	-	x	-	-	-	. ST51					
250A	N200 .	x	-	x	-	-	-	. ST51					
<b>6 steps</b>		60°	3	48 □ 20A	M10H .	x	x	x	x	x <sup>1)</sup> -	. ST61		
				32A	M20 .	x	x	x	x	- -	. ST61		
				64 □ 32A	N20 .	x	-	x	-	x	x		. ST61
				50A	N33F .	x	x	x	-	x	-		. ST61
				88 □ 63A	N40 .	x	-	x	-	x	-		. ST61
90A	N61 .	x	-	x	-	x	-	. ST61					
115A	N80 .	x	-	x	-	-	-	. ST61					
132 □ 150A	N100 .	x	-	x	-	-	-	. ST61					
250A	N200 .	x	-	x	-	-	-	. ST61					
<b>7 steps</b>		45°	4	48 □ 20A	M10H .	x	x	x	x	x <sup>1)</sup> -	. ST71		
				32A	M20 .	x	x	x	x	- -	. ST71		
				64 □ 32A	N20 .	x	-	x	-	x	x		. ST71
				50A	N33F .	x	-	x	-	x	-		. ST71
				88 □ 63A	N40 .	x	-	x	-	x	-		. ST71
90A	N61 .	x	-	x	-	x	-	. ST71					
115A	N80 .	x	-	x	-	-	-	. ST71					
132 □ 150A	N100 .	x	-	x	-	-	-	. ST71					
250A	N200 .	x	-	x	-	-	-	. ST71					

Ordering example: AC21 250A panel mounting, multi step switch 1-pole without off, 7 steps

N200 E ST71

1) Plastic enclosed switches are delivered with switch type M10.

## Switching programs

Description	Wiring diagram	Switching angle	Number of cells ↓ Size ↓ AC21	Type	Design				Switch pro-	Escutcheon plate			
					E.	Z.	V.	SMA.			P.		
<b>Multi step switches 1-pole without Off ST.1</b>													
<b>8 steps</b>		45°	4	48 □ 20A	<b>M10H</b> .	x	x	x	x	x <sup>1)</sup> -	. ST81		
				32A	<b>M20</b> .	x	x	x	x	-	-		. ST81
				64 □ 32A	<b>N20</b> .	x	-	x	-	x	x		. ST81
				50A	<b>N33F</b> .	x	-	x	-	x	-		. ST81
				88 □ 63A	<b>N40</b> .	x	-	x	-	x	-		. ST81
90A	<b>N61</b> .	x	-	x	-	x	-	. ST81					
115A	<b>N80</b> .	x	-	x	-	-	-	. ST81					
132 □ 150A	<b>N100</b> .	x	-	x	-	-	-	. ST81					
250A	<b>N200</b> .	x	-	x	-	-	-	. ST81					
<b>9 steps</b>		30°	5	48 □ 20A	<b>M10H</b> .	x	x	x	x	x <sup>1)</sup> -	. ST91		
				32A	<b>M20</b> .	x	x	x	x	-	-		. ST91
				64 □ 32A	<b>N20</b> .	x	-	x	-	x	x		. ST91
				50A	<b>N33F</b> .	x	-	x	-	x	-		. ST91
				88 □ 63A	<b>N40</b> .	x	-	x	-	x	-		. ST91
90A	<b>N61</b> .	x	-	x	-	x	-	. ST91					
115A	<b>N80</b> .	x	-	x	-	-	-	. ST91					
132 □ 150A	<b>N100</b> .	x	-	x	-	-	-	. ST91					
250A	<b>N200</b> .	x	-	x	-	-	-	. ST91					
<b>10 steps</b>		30°	5	48 □ 20A	<b>M10H</b> .	x	x	x	x	x <sup>1)</sup> -	. ST101		
				32A	<b>M20</b> .	x	x	x	x	-	-		. ST101
				64 □ 32A	<b>N20</b> .	x	-	x	-	x	x		. ST101
				50A	<b>N33F</b> .	x	-	x	-	x	-		. ST101
				88 □ 63A	<b>N40</b> .	x	-	x	-	x	-		. ST101
90A	<b>N61</b> .	x	-	x	-	x	-	. ST101					
115A	<b>N80</b> .	x	-	x	-	-	-	. ST101					
132 □ 150A	<b>N100</b> .	x	-	x	-	-	-	. ST101					
250A	<b>N200</b> .	x	-	x	-	-	-	. ST101					
<b>11 steps</b>		30°	6	48 □ 20A	<b>M10H</b> .	x	x	x	-	x <sup>1)</sup> -	. ST111		
				32A	<b>M20</b> .	x	x	x	-	-	-		. ST111
				64 □ 32A	<b>N20</b> .	x	-	x	-	x	x		. ST111
				50A	<b>N33F</b> .	x	-	x	-	x	-		. ST111
				88 □ 63A	<b>N40</b> .	x	-	x	-	x	-		. ST111
90A	<b>N61</b> .	x	-	x	-	x	-	. ST111					
115A	<b>N80</b> .	x	-	x	-	-	-	. ST111					
132 □ 150A	<b>N100</b> .	x	-	x	-	-	-	. ST111					
250A	<b>N200</b> .	x	-	x	-	-	-	. ST111					
<b>12 steps</b>		30°	6	48 □ 20A	<b>M10H</b> .	x	x	x	-	x <sup>1)</sup> -	. ST121		
				32A	<b>M20</b> .	x	x	x	-	-	-		. ST121
				64 □ 32A	<b>N20</b> .	x	-	x	-	x	x		. ST121
				50A	<b>N33F</b> .	x	-	x	-	x	-		. ST121
				88 □ 63A	<b>N40</b> .	x	-	x	-	x	-		. ST121
90A	<b>N61</b> .	x	-	x	-	x	-	. ST121					
115A	<b>N80</b> .	x	-	x	-	-	-	. ST121					
132 □ 150A	<b>N100</b> .	x	-	x	-	-	-	. ST121					
250A	<b>N200</b> .	x	-	x	-	-	-	. ST121					

**Ordering example:** AC21 250A panel mounting, multi step switch 1-pole without off, 12 steps

**N200 E ST121**

1) Plastic enclosed switches are delivered with switch type M10.

## Switching programs

Description	Wiring diagram	Switching angle	Number of cells ↓ Size ↓ AC21	Type	Design E. Z. V. SMA. P. ↓ ↓ ↓ ↓ ↓	Switch pro-	Escutcheon plate
<b>Multi step switches 1-pole with Off ST0.1</b>							
<b>2 steps</b>		60°	1 48 □ 20A	M10H . x x x x x <sup>1)</sup> - . ST021			
			32A	M20 . x x x x - - . ST021			
			64 □ 32A	N20 . x - x - x x . ST021			
			50A	N33F . x x x - x - . ST021			
			88 □ 63A	N40 . x - x - x - . ST021			
90A	N61 . x - x - x - . ST021						
115A	N80 . x - x - - - . ST021						
132 □ 150A	N100 . x - x - - - . ST021						
250A	N200 . x - x - - - . ST021						
<b>3 steps</b>		45°	2 48 □ 20A	M10H . x x x x x <sup>1)</sup> - . ST031			
			32A	M20 . x x x x - - . ST031			
			64 □ 32A	N20 . x - x - x x . ST031			
			50A	N33F . x x x - x - . ST031			
			88 □ 63A	N40 . x - x - x - . ST031			
90A	N61 . x - x - x - . ST031						
115A	N80 . x - x - - - . ST031						
132 □ 150A	N100 . x - x - - - . ST031						
250A	N200 . x - x - - - . ST031						
<b>4 steps</b>		30°	2 48 □ 20A	M10H . x x x x x <sup>1)</sup> - . ST041			
			32A	M20 . x x x x - - . ST041			
			64 □ 32A	N20 . x - x - x x . ST041			
			50A	N33F . x x x - x - . ST041			
			88 □ 63A	N40 . x - x - x - . ST041			
90A	N61 . x - x - x - . ST041						
115A	N80 . x - x - - - . ST041						
132 □ 150A	N100 . x - x - - - . ST041						
250A	N200 . x - x - - - . ST041						
<b>5 steps</b>		45°	3 48 □ 20A	M10H . x x x x x <sup>1)</sup> - . ST051			
			32A	M20 . x x x x - - . ST051			
			64 □ 32A	N20 . x - x - x x . ST051			
			50A	N33F . x x x - x - . ST051			
			88 □ 63A	N40 . x - x - x - . ST051			
90A	N61 . x - x - x - . ST051						
115A	N80 . x - x - - - . ST051						
132 □ 150A	N100 . x - x - - - . ST051						
250A	N200 . x - x - - - . ST051						
<b>6 steps</b>		45°	4 48 □ 20A	M10H . x x x x x <sup>1)</sup> - . ST061			
			32A	M20 . x x x x - - . ST061			
			64 □ 32A	N20 . x - x - x x . ST061			
			50A	N33F . x - x - x - . ST061			
			88 □ 63A	N40 . x - x - x - . ST061			
90A	N61 . x - x - x - . ST061						
115A	N80 . x - x - - - . ST061						
132 □ 150A	N100 . x - x - - - . ST061						
250A	N200 . x - x - - - . ST061						

Ordering example: AC21 250A panel mounting, multi step switch 1-pole with off, 6 steps

N200 E ST061

1) Plastic enclosed switches are delivered with switch type M10.

## Switching programs

Description	Wiring diagram	Switching angle	Number of cells ↓ Size ↓ AC21	Type	Design				Switch pro-	Escutcheon plate			
					E.	Z.	V.	SMA.			P.		
<b>Multi step switches 1-pole with Off ST0.1</b>													
<b>7 steps</b>		45°	4	48 □ 20A	M10H .	x	x	x	x	x <sup>1)</sup> -	. ST071		
				32A	M20 .	x	x	x	x	- -	. ST071		
				64 □ 32A	N20 .	x	-	x	-	x	x		. ST071
				50A	N33F .	x	-	x	-	x	-		. ST071
				88 □ 63A	N40 .	x	-	x	-	x	-		. ST071
90A	N61 .	x	-	x	-	x	-	. ST071					
115A	N80 .	x	-	x	-	-	-	. ST071					
132 □ 150A	N100 .	x	-	x	-	-	-	. ST071	+ 129 				
250A	N200 .	x	-	x	-	-	-	. ST071					
<b>8 steps</b>		30°	5	48 □ 20A	M10H .	x	x	x		x	x <sup>1)</sup> -	. ST081	
				32A	M20 .	x	x	x		x	- -	. ST081	
				64 □ 32A	N20 .	x	-	x		-	x	x	
				50A	N33F .	x	-	x	-	x	-	. ST081	
				88 □ 63A	N40 .	x	-	x	-	x	-	. ST081	
90A	N61 .	x	-	x	-	x	-	. ST081					
115A	N80 .	x	-	x	-	-	-	. ST081					
132 □ 150A	N100 .	x	-	x	-	-	-	. ST081	+ 114 				
250A	N200 .	x	-	x	-	-	-	. ST081					
<b>9 steps</b>		30°	5	48 □ 20A	M10H .	x	x	x		x	x <sup>1)</sup> -	. ST091	
				32A	M20 .	x	x	x		x	- -	. ST091	
				64 □ 32A	N20 .	x	-	x		-	x	x	
				50A	N33F .	x	-	x	-	x	-	. ST091	
				88 □ 63A	N40 .	x	-	x	-	x	-	. ST091	
90A	N61 .	x	-	x	-	x	-	. ST091					
115A	N80 .	x	-	x	-	-	-	. ST091					
132 □ 150A	N100 .	x	-	x	-	-	-	. ST091	+ 115 				
250A	N200 .	x	-	x	-	-	-	. ST091					
<b>10 steps</b>		30°	6	48 □ 20A	M10H .	x	x	x		-	x <sup>1)</sup> -	. ST0101	
				32A	M20 .	x	x	x		-	- -	. ST0101	
				64 □ 32A	N20 .	x	-	x		-	x	x	
				50A	N33F .	x	-	x	-	x	-	. ST0101	
				88 □ 63A	N40 .	x	-	x	-	x	-	. ST0101	
90A	N61 .	x	-	x	-	x	-	. ST0101					
115A	N80 .	x	-	x	-	-	-	. ST0101					
132 □ 150A	N100 .	x	-	x	-	-	-	. ST0101	+ 116 				
250A	N200 .	x	-	x	-	-	-	. ST0101					
<b>11 steps</b>		30°	6	48 □ 20A	M10H .	x	x	x		-	x <sup>1)</sup> -	. ST0111	
				32A	M20 .	x	x	x		-	- -	. ST0111	
				64 □ 32A	N20 .	x	-	x		-	x	x	
				50A	N33F .	x	-	x	-	x	-	. ST0111	
				88 □ 63A	N40 .	x	-	x	-	x	-	. ST0111	
90A	N61 .	x	-	x	-	x	-	. ST0111					
115A	N80 .	x	-	x	-	-	-	. ST0111					
132 □ 150A	N100 .	x	-	x	-	-	-	. ST0111	+ 117 				
250A	N200 .	x	-	x	-	-	-	. ST0111					

**Ordering example:** AC21 250A panel mounting, multi step switch 1-pole with off, 11 steps

**N200 E ST0111**

1) Plastic enclosed switches are delivered with switch type M10.

## Switching programs

Description	Wiring diagram	Switching angle	Number of cells ↓ Size ↓ AC21	Type	Design				Switch pro-	Escutcheon plate
					E.	Z.	V.	SMA.		
<b>Multi step switches 2-pole without Off ST.2</b>										
<b>3 steps</b>		60°	3	48 □ 20A 32A	M10H . x x x x x <sup>1)</sup> - . ST32 M20 . x x x x - - . ST32					
				64 □ 32A 50A	N20 . x - x - x x . ST32 N33F . x x x - x - . ST32					
				88 □ 63A 90A 115A	N40 . x - x - x - . ST32 N61 . x - x - x - . ST32 N80 . x - x - - - . ST32					
				132 □ 150A 250A	N100 . x - x - - - . ST32 N200 . x - x - - - . ST32					
<b>4 steps</b>		60°	4	48 □ 20A 32A	M10H . x x x x x <sup>1)</sup> - . ST42 M20 . x x x x - - . ST42					
				64 □ 32A 50A	N20 . x - x - x x . ST42 N33F . x - x - x - . ST42					
				88 □ 63A 90A 115A	N40 . x - x - x - . ST42 N61 . x - x - x - . ST42 N80 . x - x - - - . ST42					
				132 □ 150A 250A	N100 . x - x - - - . ST42 N200 . x - x - - - . ST42					
<b>5 steps</b>		60°	5	48 □ 20A 32A	M10H . x x x x x <sup>1)</sup> - . ST52 M20 . x x x x - - . ST52					
				64 □ 32A 50A	N20 . x - x - x x . ST52 N33F . x - x - x - . ST52					
				88 □ 63A 90A 115A	N40 . x - x - x - . ST52 N61 . x - x - x - . ST52 N80 . x - x - - - . ST52					
				132 □ 150A 250A	N100 . x - x - - - . ST52 N200 . x - x - - - . ST52					
<b>6 steps</b>		60°	6	48 □ 20A 32A	M10H . x x x - x <sup>1)</sup> - . ST62 M20 . x x x - - - . ST62					
				64 □ 32A 50A	N20 . x - x - x x . ST62 N33F . x - x - x - . ST62					
				88 □ 63A 90A 115A	N40 . x - x - x - . ST62 N61 . x - x - x - . ST62 N80 . x - x - - - . ST62					
				132 □ 150A 250A	N100 . x - x - - - . ST62 N200 . x - x - - - . ST62					
<b>7 steps</b>		45°	7	48 □ 20A 32A	M10H . x x x - - - . ST72 M20 . x x x - - - . ST72					
				64 □ 32A 50A	N20 . x - x - x - . ST72 N33F . x - x - - - . ST72					
				88 □ 63A 90A 115A	N40 . x - x - x - . ST72 N61 . x - x - - - . ST72 N80 . x - x - - - . ST72					
				132 □ 150A 250A	N100 . x - x - - - . ST72 N200 . x - x - - - . ST72					

Ordering example: AC21 250A panel mounting, multi step switch 2-pole without off, 7 steps

N200 E ST72

1) Plastic enclosed switches are delivered with switch type M10.

## Switching programs

Description	Wiring diagram	Switching angle	Number of cells ↓ Size ↓ AC21	Type	Design				Switch pro-	Escutcheon plate
					E.	Z.	V.	SMA. P.		
<b>Multi step switches 2-pole without Off ST.2</b>										
<b>8 steps</b>		45°	8 48 □ 20A	M10H . x x x - - - . ST82 M20 . x x x - - - . ST82						
			64 □ 32A	N20 . x - x - - - . ST82 N33F . x - x - - - . ST82						
			88 □ 63A	N40 . x - x - x - . ST82 90A N61 . x - x - - - . ST82 115A N80 . x - x - - - . ST82						
			132 □ 150A	N100 . x - x - - - . ST82 N200 . x - x - - - . ST82						
			250A							
<b>9 steps</b>		30°	9 48 □ 20A	M10H . x x x - - - . ST92 M20 . x x x - - - . ST92						
			64 □ 32A	N20 . x - x - - - . ST92 N33F . x - x - - - . ST92						
			88 □ 63A	N40 . x - x - - - . ST92 90A N61 . x - x - - - . ST92 115A N80 . x - x - - - . ST92						
			132 □ 150A	N100 . x - x - - - . ST92 N200 . x - x - - - . ST92						
			250A							
<b>10 steps</b>		30°	10 48 □ 20A	M10H . x x x - - - . ST102 M20 . x x x - - - . ST102						
			64 □ 32A	N20 . x - x - - - . ST102 N33F . x - x - - - . ST102						
			88 □ 63A	N40 . x - x - - - . ST102 90A N61 . x - x - - - . ST102 115A N80 . x - x - - - . ST102						
			132 □ 150A	N100 . x - x - - - . ST102 N200 . x - x - - - . ST102						
			250A							
<b>11 steps</b>		30°	11 48 □ 20A	M10H . x x x - - - . ST112 M20 . x x x - - - . ST112						
			64 □ 32A	N20 . x - x - - - . ST112 N33F . x - x - - - . ST112						
			88 □ 63A	N40 . x - x - - - . ST112 90A N61 . x - x - - - . ST112 115A N80 . x - x - - - . ST112						
			132 □ 150A	N100 . x - x - - - . ST112 N200 . x - x - - - . ST112						
			250A							
<b>12 steps</b>		30°	12 48 □ 20A	M10H . x x x - - - . ST122 M20 . x x x - - - . ST122						
			64 □ 32A	N20 . x - x - - - . ST122 N33F . x - x - - - . ST122						
			88 □ 63A	N40 . x - x - - - . ST122 90A N61 . x - x - - - . ST122 115A N80 . x - x - - - . ST122						
			132 □ 150A	N100 . x - x - - - . ST122 N200 . x - x - - - . ST122						
			250A							

Ordering example: AC21 250A panel mounting, multi step switch 2-pole without off, 12 steps

N200 E ST122

## Switching programs

Description	Wiring diagram	Switching angle	Number of cells ↓ Size ↓ AC21	Type	Design				Switch pro-	Escutcheon plate		
					E.	Z.	V.	SMA.			P.	
<b>Multi step switches 2-pole with Off ST0.2</b>												
2 steps		60°	2 48 □ 20A	M10H . x x x x x <sup>1)</sup> - . ST022	x	x	x	x	x <sup>1)</sup>	-	. ST022	
			64 □ 32A	M20 . x x x x - - . ST022	x	x	x	x	-	-	. ST022	
			88 □ 63A	N20 . x - x - x x . ST022	x	-	x	-	x	x	. ST022	
			90A	N33F . x x x - x - . ST022	x	x	x	-	x	-	. ST022	
			115A	N40 . x - x - x - . ST022	x	-	x	-	x	-	. ST022	
132 □ 150A	N61 . x - x - x - . ST022	x	-	x	-	x	-	. ST022	+422 			
250A	N80 . x - x - - - . ST022	x	-	x	-	-	-	. ST022				
	N100 . x - x - - - . ST022	x	-	x	-	-	-	. ST022				
	N200 . x - x - - - . ST022	x	-	x	-	-	-	. ST022				
3 steps		45°	3 48 □ 20A	M10H . x x x x x <sup>1)</sup> - . ST032	x	x	x	x	x <sup>1)</sup>	-	. ST032	
			64 □ 32A	M20 . x x x x - - . ST032	x	x	x	x	-	-	. ST032	
			88 □ 63A	N20 . x - x - x x . ST032	x	-	x	-	x	x	. ST032	
			90A	N33F . x x x - x - . ST032	x	x	x	-	x	-	. ST032	
			115A	N40 . x - x - x - . ST032	x	-	x	-	x	-	. ST032	
132 □ 150A	N61 . x - x - x - . ST032	x	-	x	-	x	-	. ST032	+127 			
250A	N80 . x - x - - - . ST032	x	-	x	-	-	-	. ST032				
	N100 . x - x - - - . ST032	x	-	x	-	-	-	. ST032				
	N200 . x - x - - - . ST032	x	-	x	-	-	-	. ST032				
4 steps		30°	4 48 □ 20A	M10H . x x x x x <sup>1)</sup> - . ST042	x	x	x	x	x <sup>1)</sup>	-	. ST042	
			64 □ 32A	M20 . x x x x - - . ST042	x	x	x	x	-	-	. ST042	
			88 □ 63A	N20 . x - x - x x . ST042	x	-	x	-	x	x	. ST042	
			90A	N33F . x - x - x - . ST042	x	-	x	-	x	-	. ST042	
			115A	N40 . x - x - x - . ST042	x	-	x	-	x	-	. ST042	
132 □ 150A	N61 . x - x - x - . ST042	x	-	x	-	x	-	. ST042	+112 			
250A	N80 . x - x - - - . ST042	x	-	x	-	-	-	. ST042				
	N100 . x - x - - - . ST042	x	-	x	-	-	-	. ST042				
	N200 . x - x - - - . ST042	x	-	x	-	-	-	. ST042				
5 steps		45°	6 48 □ 20A	M10H . x x x - x <sup>1)</sup> - . ST052	x	x	x	-	x <sup>1)</sup>	-	. ST052	
			64 □ 32A	M20 . x x x - - - . ST052	x	x	x	-	-	-	. ST052	
			88 □ 63A	N20 . x - x - x x . ST052	x	-	x	-	x	x	. ST052	
			90A	N33F . x - x - x - . ST052	x	-	x	-	x	-	. ST052	
			115A	N40 . x - x - x - . ST052	x	-	x	-	x	-	. ST052	
132 □ 150A	N61 . x - x - x - . ST052	x	-	x	-	x	-	. ST052	+423 			
250A	N80 . x - x - - - . ST052	x	-	x	-	-	-	. ST052				
	N100 . x - x - - - . ST052	x	-	x	-	-	-	. ST052				
	N200 . x - x - - - . ST052	x	-	x	-	-	-	. ST052				
6 steps		45°	7 48 □ 20A	M10H . x x x - x <sup>1)</sup> - . ST062	x	x	x	-	x <sup>1)</sup>	-	. ST062	
			64 □ 32A	M20 . x x x - - - . ST062	x	x	x	-	-	-	. ST062	
			88 □ 63A	N20 . x - x - x - . ST062	x	-	x	-	x	-	. ST062	
			90A	N33F . x - x - - - . ST062	x	-	x	-	-	-	. ST062	
			115A	N40 . x - x - x - . ST062	x	-	x	-	x	-	. ST062	
132 □ 150A	N61 . x - x - x - . ST062	x	-	x	-	x	-	. ST062	+128 			
250A	N80 . x - x - - - . ST062	x	-	x	-	-	-	. ST062				
	N100 . x - x - - - . ST062	x	-	x	-	-	-	. ST062				
	N200 . x - x - - - . ST062	x	-	x	-	-	-	. ST062				

Ordering example: AC21 250A panel mounting, multi step switch 2-pole with off, 6 steps

N200 E ST062

1) Plastic enclosed switches are delivered with switch type M10.

## Switching programs

Description	Wiring diagram	Switching angle	Number of cells ↓ Size ↓ AC21	Type	Design				Switch pro-	Escutcheon plate
					E.	Z.	V.	SMA. P.		
<b>Multi step switches 2-pole with Off ST0.2</b>										
<b>7 steps</b>		45°	8	48 □ 20A 32A	<b>M10H</b> . x x x - - - . <b>ST072</b> <b>M20</b> . x x x - - - . <b>ST072</b>					
			64 □ 32A 50A	<b>N20</b> . x - x - - - . <b>ST072</b> <b>N33F</b> . x - x - - - . <b>ST072</b>						
			88 □ 63A 90A 115A	<b>N40</b> . x - x - - x - . <b>ST072</b> <b>N61</b> . x - x - - - . <b>ST072</b> <b>N80</b> . x - x - - - . <b>ST072</b>						
			132 □ 150A 250A	<b>N100</b> . x - x - - - . <b>ST072</b> <b>N200</b> . x - x - - - . <b>ST072</b>						
<b>8 steps</b>		30°	9	48 □ 20A 32A	<b>M10H</b> . x x x - - - . <b>ST082</b> <b>M20</b> . x x x - - - . <b>ST082</b>					
			64 □ 32A 50A	<b>N20</b> . x - x - - - . <b>ST082</b> <b>N33F</b> . x - x - - - . <b>ST082</b>						
			88 □ 63A 90A 115A	<b>N40</b> . x - x - - - . <b>ST082</b> <b>N61</b> . x - x - - - . <b>ST082</b> <b>N80</b> . x - x - - - . <b>ST082</b>						
			132 □ 150A 250A	<b>N100</b> . x - x - - - . <b>ST082</b> <b>N200</b> . x - x - - - . <b>ST082</b>						
<b>9 steps</b>		30°	10	48 □ 20A 32A	<b>M10H</b> . x x x - - - . <b>ST092</b> <b>M20</b> . x x x - - - . <b>ST092</b>					
			64 □ 32A 50A	<b>N20</b> . x - x - - - . <b>ST092</b> <b>N33F</b> . x - x - - - . <b>ST092</b>						
			88 □ 63A 90A 115A	<b>N40</b> . x - x - - - . <b>ST092</b> <b>N61</b> . x - x - - - . <b>ST092</b> <b>N80</b> . x - x - - - . <b>ST092</b>						
			132 □ 150A 250A	<b>N100</b> . x - x - - - . <b>ST092</b> <b>N200</b> . x - x - - - . <b>ST092</b>						
<b>10 steps</b>		30°	11	48 □ 20A 32A	<b>M10H</b> . x x x - - - . <b>ST0102</b> <b>M20</b> . x x x - - - . <b>ST0102</b>					
			64 □ 32A 50A	<b>N20</b> . x - x - - - . <b>ST0102</b> <b>N33F</b> . x - x - - - . <b>ST0102</b>						
			88 □ 63A 90A 115A	<b>N40</b> . x - x - - - . <b>ST0102</b> <b>N61</b> . x - x - - - . <b>ST0102</b> <b>N80</b> . x - x - - - . <b>ST0102</b>						
			132 □ 150A 250A	<b>N100</b> . x - x - - - . <b>ST0102</b> <b>N200</b> . x - x - - - . <b>ST0102</b>						
<b>11 steps</b>		30°	12	48 □ 20A 32A	<b>M10H</b> . x x x - - - . <b>ST0112</b> <b>M20</b> . x x x - - - . <b>ST0112</b>					
			64 □ 32A 50A	<b>N20</b> . x - x - - - . <b>ST0112</b> <b>N33F</b> . x - x - - - . <b>ST0112</b>						
			88 □ 63A 90A 115A	<b>N40</b> . x - x - - - . <b>ST0112</b> <b>N61</b> . x - x - - - . <b>ST0112</b> <b>N80</b> . x - x - - - . <b>ST0112</b>						
			132 □ 150A 250A	<b>N100</b> . x - x - - - . <b>ST0112</b> <b>N200</b> . x - x - - - . <b>ST0112</b>						

Ordering example: AC21 250A panel mounting, multi step switch 2-pole with off, 11 steps **N200 E ST0112**

## Switching programs

Description	Wiring diagram	Switching angle	Number of cells ↓ Size ↓ AC21	Type	Design				Switch pro-	Escutcheon plate
					E.	Z.	V.	SMA. P.		
Multi step switches 3-pole without Off ST.3										
<b>3 steps</b>		60°	5	48 □ 20A 32A	M10H . x x x x x <sup>1)</sup> - . ST33 M20 . x x x x - - . ST33					
				64 □ 32A 50A	N20 . x - x - x x . ST33 N33F . x - x - x - . ST33					
				88 □ 63A 90A 115A	N40 . x - x - x - . ST33 N61 . x - x - x - . ST33 N80 . x - x - - - . ST33					
				132 □ 150A 250A	N100 . x - x - - - . ST33 N200 . x - x - - - . ST33					
<b>4 steps</b>		60°	6	48 □ 20A 32A	M10H . x x x - x <sup>1)</sup> - . ST43 M20 . x x x - - - . ST43					
				64 □ 32A 50A	N20 . x - x - x x . ST43 N33F . x - x - x - . ST43					
				88 □ 63A 90A 115A	N40 . x - x - x - . ST43 N61 . x - x - x - . ST43 N80 . x - x - - - . ST43					
				132 □ 150A 250A	N100 . x - x - - - . ST43 N200 . x - x - - - . ST43					
<b>5 steps</b>		60°	8	48 □ 20A 32A	M10H . x x x - - - . ST53 M20 . x x x - - - . ST53					
				64 □ 32A 50A	N20 . x - x - x - . ST53 N33F . x - x - - - . ST53					
				88 □ 63A 90A 115A	N40 . x - x - x - . ST53 N61 . x - x - - - . ST53 N80 . x - x - - - . ST53					
				132 □ 150A 250A	N100 . x - x - - - . ST53 N200 . x - x - - - . ST53					
<b>6 steps</b>		60°	9	48 □ 20A 32A	M10H . x x x - - - . ST63 M20 . x x x - - - . ST63					
				64 □ 32A 50A	N20 . x - x - - - . ST63 N33F . x - x - - - . ST63					
				88 □ 63A 90A 115A	N40 . x - x - - - . ST63 N61 . x - x - - - . ST63 N80 . x - x - - - . ST63					
				132 □ 150A 250A	N100 . x - x - - - . ST63 N200 . x - x - - - . ST63					
<b>7 steps</b>		45°	11	48 □ 20A 32A	M10H . x x x - - - . ST73 M20 . x x x - - - . ST73					
				64 □ 32A 50A	N20 . x - x - - - . ST73 N33F . x - x - - - . ST73					
				88 □ 63A 90A 115A	N40 . x - x - - - . ST73 N61 . x - x - - - . ST73 N80 . x - x - - - . ST73					
				132 □ 150A 250A	N100 . x - x - - - . ST73 N200 . x - x - - - . ST73					

Ordering example: AC21 250A panel mounting, multi step switch 3-pole without off, 7 steps

N200 E ST73

1) Plastic enclosed switches are delivered with switch type M10.

## Switching programs

Description	Wiring diagram	Switching angle	Number of cells ↓ Size ↓ AC21	Type	Design E. Z. V. SMA. P. ↓ ↓ ↓ ↓	Switch pro-	Escutcheon plate
<b>Multi step switches 3-pole without Off ST.3</b>							
<b>8 steps</b>		45°	12 48 □ 20A	M10H . x x x - - - . ST83 M20 . x x x - - - . ST83			
			64 □ 32A	N20 . x - x - - - . ST83 N33F . x - x - - - . ST83			
			88 □ 63A	N40 . x - x - - - . ST83 90A N61 . x - x - - - . ST83 115A N80 . x - x - - - . ST83			
			132 □ 150A	N100 . x - x - - - . ST83 250A N200 . x - x - - - . ST83			
<b>9 steps</b>		30°	14 48 □ 20A	M10H . x - x - - - . ST93 M20 . x - x - - - . ST93			
			64 □ 32A	N20 . x - x - - - . ST93 N33F . x - x - - - . ST93			
			88 □ 63A	N40 . x - x - - - . ST93 90A N61 . x - x - - - . ST93 115A N80 . x - x - - - . ST93			
			132 □ 150A	N100 . x - x - - - . ST93 250A N200 . x - x - - - . ST93			
<b>10 steps</b>		30°	15 48 □ 20A	M10H . x - x - - - . ST103 M20 . x - x - - - . ST103			
			64 □ 32A	N20 . x - x - - - . ST103 N33F . x - x - - - . ST103			
			88 □ 63A	N40 . x - x - - - . ST103 90A N61 . x - x - - - . ST103 115A N80 . x - x - - - . ST103			
			132 □ 150A	N100 . x - x - - - . ST103 250A N200 . x - x - - - . ST103			
<b>11 steps</b>		30°	17 48 □ 20A	M10H . x - x - - - . ST113 M20 . x - x - - - . ST113			
			64 □ 32A	N20 . x - x - - - . ST113 N33F . x - x - - - . ST113			
			88 □ 63A	N40 . x - x - - - . ST113 90A N61 . x - x - - - . ST113 115A N80 . x - x - - - . ST113			
			132 □ 150A	N100 . x - x - - - . ST113 250A N200 . x - x - - - . ST113			
<b>12 steps</b>		30°	18 48 □ 20A	M10H . x - x - - - . ST123 M20 . x - x - - - . ST123			
			64 □ 32A	N20 . x - x - - - . ST123 N33F . x - x - - - . ST123			
			88 □ 63A	N40 . x - x - - - . ST123 90A N61 . x - x - - - . ST123 115A N80 . x - x - - - . ST123			
			132 □ 150A	N100 . x - x - - - . ST123 250A N200 . x - x - - - . ST123			

Ordering example: AC21 250A panel mounting, multi step switch 3-pole without off, 12 steps

N200 E ST123

## Switching programs

Description	Wiring diagram	Switching angle	Number of cells ↓ Size ↓ AC21	Type	Design				Switch pro-	Escutcheon plate			
					E.	Z.	V.	SMA.			P.		
<b>Multi step switches 3-pole with Off ST0.3</b>													
2 steps		60°	3	48 □ 20A	M10H .	x	x	x	x	x <sup>1)</sup>	-	. ST023	
				32A	M20 .	x	x	x	x	-	-	. ST023	
				64 □ 32A	N20 .	x	-	x	-	x	x	. ST023	
				50A	N33F .	x	x	x	-	x	-	. ST023	
				88 □ 63A	N40 .	x	-	x	-	x	-	. ST023	
90A	N61 .	x	-	x	-	x	-	. ST023					
115A	N80 .	x	-	x	-	-	-	. ST023					
132 □ 150A	N100 .	x	-	x	-	-	-	. ST023					
250A	N200 .	x	-	x	-	-	-	. ST023					
3 steps		45°	5	48 □ 20A	M10H .	x	x	x	x	x <sup>1)</sup>	-	. ST033	
				32A	M20 .	x	x	x	x	-	-	. ST033	
				64 □ 32A	N20 .	x	-	x	-	x	x	. ST033	
				50A	N33F .	x	-	x	-	x	-	. ST033	
				88 □ 63A	N40 .	x	-	x	-	x	-	. ST033	
90A	N61 .	x	-	x	-	x	-	. ST033					
115A	N80 .	x	-	x	-	-	-	. ST033					
132 □ 150A	N100 .	x	-	x	-	-	-	. ST033					
250A	N200 .	x	-	x	-	-	-	. ST033					
4 steps		30°	6	48 □ 20A	M10H .	x	x	x	-	x <sup>1)</sup>	-	. ST043	
				32A	M20 .	x	x	x	-	-	-	. ST043	
				64 □ 32A	N20 .	x	-	x	-	x	x	. ST043	
				50A	N33F .	x	-	x	-	x	-	. ST043	
				88 □ 63A	N40 .	x	-	x	-	x	-	. ST043	
90A	N61 .	x	-	x	-	x	-	. ST043					
115A	N80 .	x	-	x	-	-	-	. ST043					
132 □ 150A	N100 .	x	-	x	-	-	-	. ST043					
250A	N200 .	x	-	x	-	-	-	. ST043					
5 steps		45°	9	48 □ 20A	M10H .	x	x	x	-	-	-	. ST053	
				32A	M20 .	x	x	x	-	-	-	. ST053	
				64 □ 32A	N20 .	x	-	x	-	-	-	. ST053	
				50A	N33F .	x	-	x	-	-	-	. ST053	
				88 □ 63A	N40 .	x	-	x	-	-	-	. ST053	
90A	N61 .	x	-	x	-	-	-	. ST053					
115A	N80 .	x	-	x	-	-	-	. ST053					
132 □ 150A	N100 .	x	-	x	-	-	-	. ST053					
250A	N200 .	x	-	x	-	-	-	. ST053					
6 steps		45°	11	48 □ 20A	M10H .	x	x	x	-	-	-	. ST063	
				32A	M20 .	x	x	x	-	-	-	. ST063	
				64 □ 32A	N20 .	x	-	x	-	-	-	. ST063	
				50A	N33F .	x	-	x	-	-	-	. ST063	
				88 □ 63A	N40 .	x	-	x	-	-	-	. ST063	
90A	N61 .	x	-	x	-	-	-	. ST063					
115A	N80 .	x	-	x	-	-	-	. ST063					
132 □ 150A	N100 .	x	-	x	-	-	-	. ST063					
250A	N200 .	x	-	x	-	-	-	. ST063					

**Ordering example:** AC21 250A panel mounting, multi step switch 3-pole with off, 6 steps **N200 E ST063**

1) Plastic enclosed switches are delivered with switch type M10.

## Switching programs

Description	Wiring diagram	Switching angle	Number of cells ↓ Size ↓ AC21	Type	Design				Switch pro-	Escutcheon plate
					E.	Z.	V.	SMA. P.		
<b>Multi step switches 3-pole with Off ST0.3</b>										
7 steps		45°	12 48 □ 20A	M10H . x x x - - - . ST073 M20 . x x x - - - . ST073						
			64 □ 32A	N20 . x - x - - - . ST073 N33F . x - x - - - . ST073						
			88 □ 63A	N40 . x - x - - - . ST073 N61 . x - x - - - . ST073 N80 . x - x - - - . ST073						
			132 □ 150A	N100 . x - x - - - . ST073 N200 . x - x - - - . ST073						
8 steps		30°	14 48 □ 20A	M10H . x - x - - - . ST083 M20 . x - x - - - . ST083						
			64 □ 32A	N20 . x - x - - - . ST083 N33F . x - x - - - . ST083						
			88 □ 63A	N40 . x - x - - - . ST083 N61 . x - x - - - . ST083 N80 . x - x - - - . ST083						
			132 □ 150A	N100 . x - x - - - . ST083 N200 . x - x - - - . ST083						
9 steps		30°	15 48 □ 20A	M10H . x - x - - - . ST093 M20 . x - x - - - . ST093						
			64 □ 32A	N20 . x - x - - - . ST093 N33F . x - x - - - . ST093						
			88 □ 63A	N40 . x - x - - - . ST093 N61 . x - x - - - . ST093 N80 . x - x - - - . ST093						
			132 □ 150A	N100 . x - x - - - . ST093 N200 . x - x - - - . ST093						
10 steps		30°	17 48 □ 20A	M10H . x - x - - - . ST0103 M20 . x - x - - - . ST0103						
			64 □ 32A	N20 . x - x - - - . ST0103 N33F . x - x - - - . ST0103						
			88 □ 63A	N40 . x - x - - - . ST0103 N61 . x - x - - - . ST0103 N80 . x - x - - - . ST0103						
			132 □ 150A	N100 . x - x - - - . ST0103 N200 . x - x - - - . ST0103						
11 steps		30°	18 48 □ 20A	M10H . x - x - - - . ST0113 M20 . x - x - - - . ST0113						
			64 □ 32A	N20 . x - x - - - . ST0113 N33F . x - x - - - . ST0113						
			88 □ 63A	N40 . x - x - - - . ST0113 N61 . x - x - - - . ST0113 N80 . x - x - - - . ST0113						
			132 □ 150A	N100 . x - x - - - . ST0113 N200 . x - x - - - . ST0113						

Ordering example: AC21 250A panel mounting, multi step switch 3-pole with off, 11 steps

N200 E ST0113

# Mini-Cam Switches M4H

Panel mounting E, IP40

Central fixing Z

Central fixing without escutcheon plate ZO

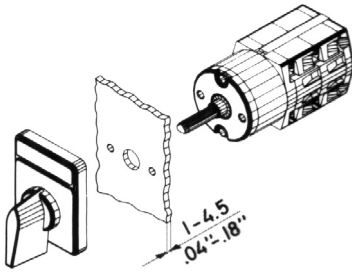
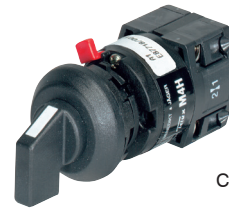

Mounting holes

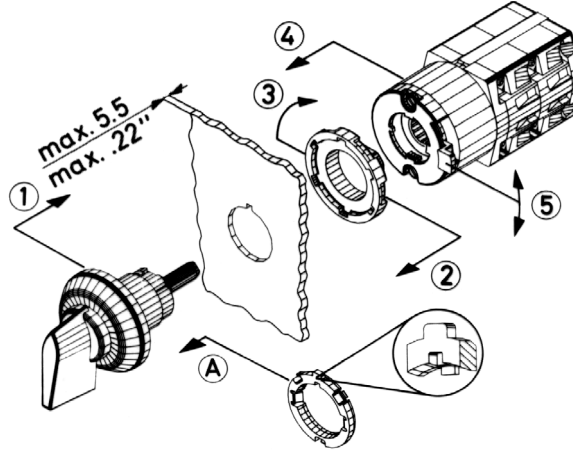
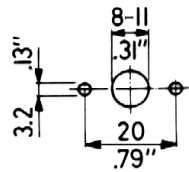

Central fixing 16mm

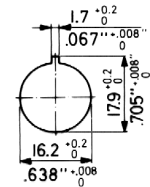

lock

unlock Central fixing 22mm

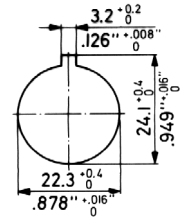

Single hole mountings are generally delivered for a 16mm (.64") mounting. Using the forwarded adapter ring, it is possible to alter the single hole mountings from 22mm (.88"). For that purpose the adapter ring has to be attached onto the threaded part of the body in such a manner, that  
 1. the flat side of the adapter ring shows towards the front seal and  
 2. the inner nose fits into the notch of the body.  
 The adapter ring has to be pushed towards the front seal.

Optional extras	ordering code	for design	M4H Z ... +SRE	M4H Z ... +SA.	M4H ZO ... +SA.	M4H Z ... +SRE+SA.
Additional escutcheon plate	+SRE	E, Z, ZO				
Additional escutcheon plate	+SRE2	E, Z, ZO				
Key operated switch with lock KABA	+SA1	Z, ZO				
with lock Ronis	+SA2	Z, ZO				

**Wrench J7400**  
for switches M4H with central fixing is necessary

## Panel mounting E

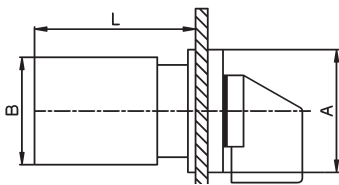

## Central fixing Z, ZO

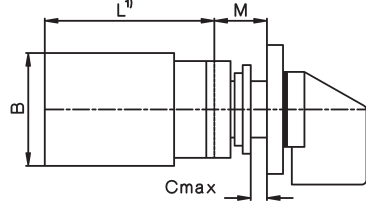

## ZO

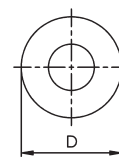

## Z

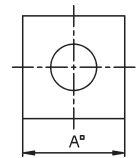

Type	A	B	D	M	Dimension L for ... cells								
					1	2	3	4	5	6	7	8	
M4H	mm	30	28	29,5	12,5	38,5	50,5	62,5	74,5	86,5	98,5	110,5	122,5

## Technical data

Type	according to specifications	AC21A	AC15		Volt	Motor rating AC3						
			110V	380V		3 phase 3-pole			1 phase 2-pole			
M4H	IEC, VDE, BS, SEV UL, CSA	General use 10A/500V 10A/300V	2,5A	1,5A	kW HP	0,65	1,5	2,2	0,3	0,55	-	0,75
			A300	0,75		1	-	0,33	0,75	0,75	-	

Type	according to specifications	Volt	Motor rating AC23			2-pole		
			3-pole	110	220	380	110	220
M4H	IEC, VDE, BS, SEV UL, CSA	kW HP	0,75	1,8	3	0,37	0,75	1,1
			-	-	-	-	-	-

## additional data for wiring according to UL and CSA

Type	type of wire	temp. rating of wire	torque value for field wiring terminals
M4H	copper wire only	60/75°C	0,4Nm / 3,5lb - inch

# Mini-Cam Switches M4H

## Switch programs

Description	Wiring diagram	AC21 500V 10A AC15 230V 2,5A AC3 4x400V 2,2kW	escutch. 30 x 30	numb. of cells	Type	Design			Switch pro- gram
						.E. ↓	.Z. ↓	.ZO. ↓	
<b>On-Off-switch A</b>									
1-pole				1	M4H	x	x	x	. A1
2-pole				1	M4H	x	x	x	. A2
3-pole				2	M4H	x	x	x	. A3
4-pole				2	M4H	x	x	x	. A4
6-pole				3	M4H	x	x	x	. A6
<b>Changeover switch U</b>									
1-pole				1	M4H	x	x	x	. U1
2-pole				2	M4H	x	x	x	. U2
3-pole				3	M4H	x	x	x	. U3
4-pole				4	M4H	x	x	x	. U4
<b>Changeover switch without off W</b>									
1-pole				1	M4H	x	x	x	. W1
2-pole				2	M4H	x	x	x	. W2
3-pole				3	M4H	x	x	x	. W3
4-pole				4	M4H	x	x	x	. W4
6-pole				6	M4H	x	x	x	. W6
<b>Reversing switch WU</b>									
2-pole				2	M4H	x	x	x	. WU2
3-pole				3	M4H	x	x	x	. WU3
3-pole with spring return to 0				3	M4H	x	x	x	. WU3R2
<b>Star-delta switch SD</b>									
1 rotary direction				4	M4H	x	x	x	. SD
both rotary directions				5	M4H	x	x	x	. SDR
<b>Changeover with spring return UR</b>									
1-pole				1	M4H	x	x	x	. UR1
2-pole				2	M4H	x	x	x	. UR2
3-pole				3	M4H	x	x	x	. UR3
<b>Start switch</b>									
1-pole				1	M4H	x	x	x	. SE
<b>Stop switch</b>									
1-pole				1	M4H	x	x	x	. SA

Ordering example: Stop switch, 1-pole, Central fixing: **M4H Z SA**

# Mini-Cam Switches M4H

## Switch programs

Description	Wiring diagram	AC21 500V 10A AC15 230V 2,5A AC3 4x400V 2,2kW	escutch. 30 x 30	numb. of cells	Type	Design			Switch program
						.E. ↓	.Z. ↓	.ZO. ↓	
<b>Start-Stop switch</b>				1	M4H	x	x	x	. SEA
<b>Start-Stop switch position START with spring return to 1</b>				1	M4H	x	x	x	. S392
<b>Start-Stop switch for reversing contactors</b>				2	M4H	x	x	x	. S2EA
<b>Voltmeter selector switch V</b>									
<b>3 line voltages</b>				2	M4H	x	x	x	. V3
<b>3 phase voltages</b>				2	M4H	x	x	x	. V0
<b>3 line voltages 3 phase voltages</b>				3	M4H	x	x	x	. V1
<b>Ammeter selector switch A</b>									
<b>1-pole, 3 current transformer</b>				4	M4H	x	x	x	. M31
<b>Gang switch GR</b>									
<b>2 circuits A and B 1-pole 0 - A - A+B</b>				1	M4H	x	x	x	. GR11
<b>2 circuits A and B 1-pole 0 - A - B - A+B</b>				1	M4H	x	x	x	. GR12
<b>3 circuits A, B and C 1-pole</b>				2	M4H	x	x	x	. GR14
<b>Multi step switch without 0 ST</b>									
<b>3 steps, 1-pole</b>				2	M4H	x	x	x	. ST31
<b>3 steps, 2-pole</b>				3	M4H	x	x	x	. ST32
<b>3 steps, 3-pole</b>				5	M4H	x	x	x	. ST33

Ordering example: Multi step switch without 0, 3 steps, 3-pole, panel mounting: **M4H E ST33**



# Mini-Cam Switches M4H

## Switch programs

Description	Wiring diagram	AC21 500V 10A AC15 230V 2,5A AC3 4x400V 2,2kW	escutch. 30 x 30	numb. of cells	Type	Design			Switch pro- gram
						E. ↓	Z. ↓	ZO. ↓	
<b>Multi step switch without 0 ST</b>									
4 steps, 1-pole				2	M4H	x	x	x	.ST41
4 steps, 2-pole				4	M4H	x	x	x	.ST42
4 steps, 3-pole				6	M4H	x	x	x	.ST43
5 steps, 1-pole				3	M4H	x	x	x	.ST51
5 steps, 2-pole				5	M4H	x	x	x	.ST52
6 steps, 1-pole				3	M4H	x	x	x	.ST61
6 steps, 2-pole				6	M4H	x	x	x	.ST62
<b>Multi step switch with 0 ST0.</b>									
2 steps, 1-pole				1	M4H	x	x	x	.ST021
2 steps, 2-pole				2	M4H	x	x	x	.ST022
2 steps, 3-pole				3	M4H	x	x	x	.ST023
3 steps, 1-pole				2	M4H	x	x	x	.ST031
3 steps, 2-pole				3	M4H	x	x	x	.ST032
3 steps, 3-pole				5	M4H	x	x	x	.ST033
4 steps, 1-pole				2	M4H	x	x	x	.ST041
4 steps, 2-pole				4	M4H	x	x	x	.ST042
4 steps, 3-pole				6	M4H	x	x	x	.ST043
5 steps, 1-pole				3	M4H	x	x	x	.ST051
5 steps, 2-pole				5	M4H	x	x	x	.ST052
6 steps, 1-pole				4	M4H	x	x	x	.ST061
7 steps, 1-pole				4	M4H	x	x	x	.ST071
8 steps, 1-pole				5	M4H	x	x	x	.ST081
9 steps, 1-pole				5	M4H	x	x	x	.ST091
10 steps, 1-pole				6	M4H	x	x	x	.ST0101

Ordering example: Multi step switch with 0, 10 steps, 1-pole, Central fixing without escutcheon plate: **M4H ZO ST0101**

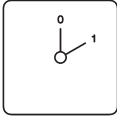
## Load Switches for resistive or slightly inductive loads or switching without load

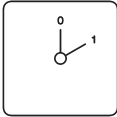
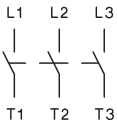
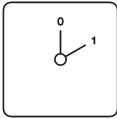
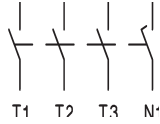
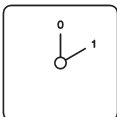
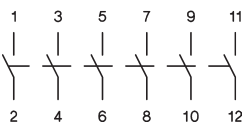
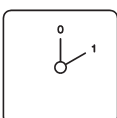
Description	Wiring diagram	Switching angle	Number of cells ↓ Size ↓ AC21	Type	Design		Switch program	Escutcheon plate
					.E.	.V.		
<b>On-Off-switches A</b>								
<b>1-pole</b>		60°	2 88 □ 125A	L100 .	x	x	. A1	
			1 132 □ 400A	L400 .	x	x	. A1	
			3 600A	L600 .	x	x	. A1	
			2 800A	L800 .	x	x	. A1	
			3 1200A	L1200 .	x	x	. A1	
<b>2-pole</b>		60°	2 88 □ 125A	L100 .	x	x	. A2	
			2 132 □ 400A	L400 .	x	x	. A2	
			3 600A	L600 .	x	x	. A2	
			4 800A	L800 .	x	x	. A2	
			6 1200A	L1200 .	x	x	. A2	
<b>3-pole</b>		60°	4 88 □ 125A	L100 .	x	x	. A3	
			3 132 □ 400A	L400 .	x	x	. A3	
			6 600A	L600 .	x	x	. A3	
			6 800A	L800 .	x	x	. A3	
			9 1200A	L1200 .	x	x	. A3	
<b>4-pole</b> <b>4. pole early make</b>		60°	4 88 □ 125A	L100 .	x	x	. A4	
			4 132 □ 400A	L400 .	x	x	. A4	
			6 600A	L600 .	x	x	. A4	
			8 800A	L800 .	x	x	. A4	
			12 1200A	L1200 .	x	x	. A4	
<b>6-pole</b>		60°	6 88 □ 125A	L100 .	x	x	. A6	
			6 132 □ 400A	L400 .	x	x	. A6	
			9 600A	L600 .	x	x	. A6	
			12 800A	L800 .	x	x	. A6	
			18 1200A	L1200 .	x	x	. A6	

For switches with the design V., it is necessary to state the installation depth - that is, the distance between mounting level of the switch and the inside edge of the door (dimension T).

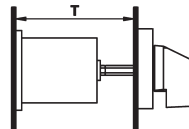

Further informations page  
 Technical Data 259  
 Dimensions 262

**Load Switches** for resistive or slightly inductive loads or switching without load

Description	Wiring diagram	Switching angle	Number of cells ↓ Size ↓ AC21	Type	Design .E. .V. ↓ ↓	Switch pro- gram	Escutcheon plate
<b>Changeover switches U</b>							
<b>1-pole</b>		60°	2 88 □ 125A	L100 .	x x	. U1	
			2 180A	L160 .	x x	. U1	
			2 132 □ 400A	L400 .	x x	. U1	
			3 600A	L600 .	x x	. U1	
			4 800A	L800 .	x x	. U1	
6 1200A	L1200 .	x x	. U1				
<b>2-pole</b>		60°	4 88 □ 125A	L100 .	x x	. U2	
			4 180A	L160 .	x x	. U2	
			4 132 □ 400A	L400 .	x x	. U2	
			6 600A	L600 .	x x	. U2	
			8 800A	L800 .	x x	. U2	
12 1200A	L1200 .	x x	. U2				
<b>3-pole</b>		60°	6 88 □ 125A	L100 .	x x	. U3	
			6 180A	L160 .	x x	. U3	
			6 132 □ 400A	L400 .	x x	. U3	
			9 600A	L600 .	x x	. U3	
			12 800A	L800 .	x x	. U3	
18 1200A	L1200 .	x x	. U3				
<b>4-pole 4. pole early make</b>		60°	8 88 □ 125A	L100 .	x x	. U4	
			8 180A	L160 .	x x	. U4	
			8 132 □ 400A	L400 .	x x	. U4	
			12 600A	L600 .	x x	. U4	
			16 800A	L800 .	x x	. U4	
24 1200A	L1200 .	x x	. U4				
<b>Changeover switches without off W</b>							
<b>1-pole</b>		60°	2 88 □ 125A	L100 .	x x	. W1	
			2 180A	L160 .	x x	. W1	
			2 132 □ 400A	L400 .	x x	. W1	
			3 600A	L600 .	x x	. W1	
			4 800A	L800 .	x x	. W1	
6 1200A	L1200 .	x x	. W1				
<b>2-pole</b>		60°	4 88 □ 125A	L100 .	x x	. W2	
			4 180A	L160 .	x x	. W2	
			4 132 □ 400A	L400 .	x x	. W2	
			6 600A	L600 .	x x	. W2	
			8 800A	L800 .	x x	. W2	
12 1200A	L1200 .	x x	. W2				
<b>3-pole</b>		60°	6 88 □ 125A	L100 .	x x	. W3	
			6 180A	L160 .	x x	. W3	
			6 132 □ 400A	L400 .	x x	. W3	
			9 600A	L600 .	x x	. W3	
			12 800A	L800 .	x x	. W3	
18 1200A	L1200 .	x x	. W3				
<b>4-pole 4. pole early make</b>		60°	8 88 □ 125A	L100 .	x x	. W4	
			8 180A	L160 .	x x	. W4	
			8 132 □ 400A	L400 .	x x	. W4	
			12 600A	L600 .	x x	. W4	
			16 800A	L800 .	x x	. W4	
24 1200A	L1200 .	x x	. W4				

**Ordering example:** AC1 1200A panel mounting, changeover switch without off 4-pole **L1200 E W4**

## Operating Knobs and Handles

### Types of handles

In the standard version, the switches are supplied with a black twist knob or instrument knob (M10H - N33F), except for design SMA, which has a grey toggle knob. Switches of size L, which consist of 2 or 3 switch columns, come with a black hand wheel. If required, the switch can be supplied with other knobs, which can later easily be exchanged. All operating knobs have an insert, which sets the position of the knob in relation to the switch shaft. This insert can be mounted in 8 different positions (at intervals of 45°), causing the angle of each individual switch setting to be rotated by 45°.

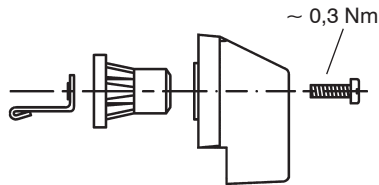

In the standard version, the switch terminals are positioned left and right (except M10H). When the knob insert is turned by 90°, the lay-out of the terminals changes to top and bottom.



All operating knobs can be moved on the hexagonal shaft, to permit adaptation to different sheet thicknesses, etc.

Type	M10 M10H M10HD M20	N20 N33F	N40 N61 N80 L100	N100 N200 L400 L600 L800 L1200
Knob movement mm	5	5	7	9
Hexagonal shaft dimension mm	5	7	9	12

**Ordering example:** Cam switch N61 V U3 with Instrument knob red  
**Order type:** N61 V U3 +G3  
**Dimensions** see page 267

Knobs and handles Description	Colour	Ordering Code	M10 M10H M10HD M20	N20 N33F	N40 N61 N80 L100	N100 N200 L400 L600 L800 L1200
 <b>Instrument knob</b> Standard for M10 to N200	grey	+G1	X	X		
	black	+G2	X	X	X	
	red	+G3	X	X		
	white	+G5	X	X		
 <b>Toggle knob</b>	grey	+K1	X	X		
	black	+K2	X	X		
	red	+K3	X	X		
	white	+K5	X	X		
	white	+K5	X	X		
	blue	+K6	X			

## Escutcheon Plates

**TELUX-Cam Switches** in designs E, V, P, PF, SM, UP, Z and KE are supplied with a square escutcheon plate consisting of a black frame and plexi insert plate. The markings are printed in black on the back of the insert plate. To protect the markings so that they remain easy to read, the back of the insert plate is lined with silver foil. In addition, rectangular plates can be provided for all switch sizes, which can be fitted on all switches after mounting.

Square plate

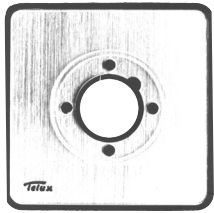

Rectangular plate  
(with square plate)  
Slot on the cover plate  
upper side

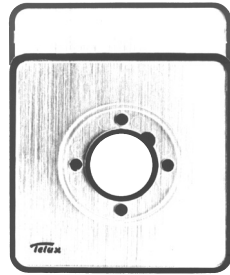

Preferred position of the slot  
on bottom of  
the cover plate

Slot for additional plate

**TELUX-Cam Switches** in design SMA, for distribution boards with 45mm inside edge of installation cover, is supplied with a grey cover and black markings.



**Special engraved markings** on escutcheon plates are limited by the available space. In the case of relatively large production runs or frequent use of the text, we recommend ordering of a printing block. This will be invoiced at cost price, and the engraving will not be charged for. This investment generally pays with batches from 50 pieces upwards.

The "escutcheon plate" column of the selection and ordering tables for switch programs indicates the standard plate and, in some cases, an additional plate that is often used for the programs in question. If such a plate, listed in the selection table, is desired, the appropriate code number should be stated when ordering a switch and switch program.

Should only **plates** or **parts** of the latter be ordered, the order type is assembled as shown by the following example.

**Code letter** of switch sizes

M10, M10H, M10HD, M20	<b>A</b>
N20, N33F	<b>E</b>
N40, N61, N80, L100	<b>H</b>
N100, N200, L400, L600, L800, L1200	<b>L</b>

**Ordering example:** Escutcheon plate silver, complete, for cam switch M10, marked with MAN OFF AUTO, angle of rotation 60°

Order type:

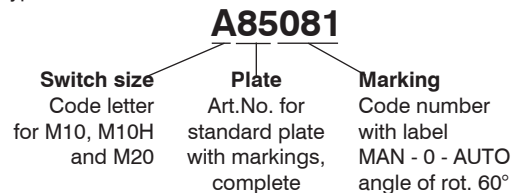

However, if a **switch** with non-standard lettering is required, only three-digit code number for the marking need be added to the order type (see next page).

**Dimensions** see page 267

Description	Order type Switch size Code letter	Plate Art.No.	Marking Code number
<b>Escutcheon plate for designs E, V, P, Z, SM, KE and UP</b> Escutcheon frame black, plexi insert plate silver, markings black			
Plexi insert plate silver	A E H L	.85...	... (see pp. 244-248)
Plexi insert plate yellow	A E H L	.80...	... (see pp. 244-248)
Escutcheon frame black	A E H L	.8203	-
<b>Rectangular escutcheon plate for designs E, V, Z and SM</b> Escutcheon frame black, plexi insert plate silver, markings black			
Plexi insert plate silver	A E H L	.885..	... (see pp. 244-248)
Plexi insert plate yellow	A E H L	.895..	... (see pp. 244-248)
Escutcheon frame black	A E H L	.8503	-
<b>Installation cover for design SMA</b> grey cover, markings black	A - - -	.69...	... (see page 246)

## Escutcheon Plates

### Selected standard markings

The markings that are most commonly required are shown below, together with code letters for the switch size and the code number.

**Ordering example:** Switch type M10H E A3 with escutcheon plate "OFF ON" and additional rectangular escutcheon plate "PUMP"

Order type: **M10H E A3 +003 +516**

### Code letter of switch sizes

M10, M10H, M10HD, M20  
N20, N33F  
N40, N61, N80, L100  
N100, N200, L400, L600, L800, L1200

A  
E  
H  
L

### Blank escutcheon plates

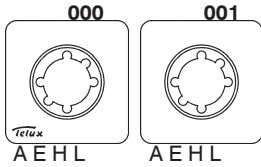

### Switching angle 30°

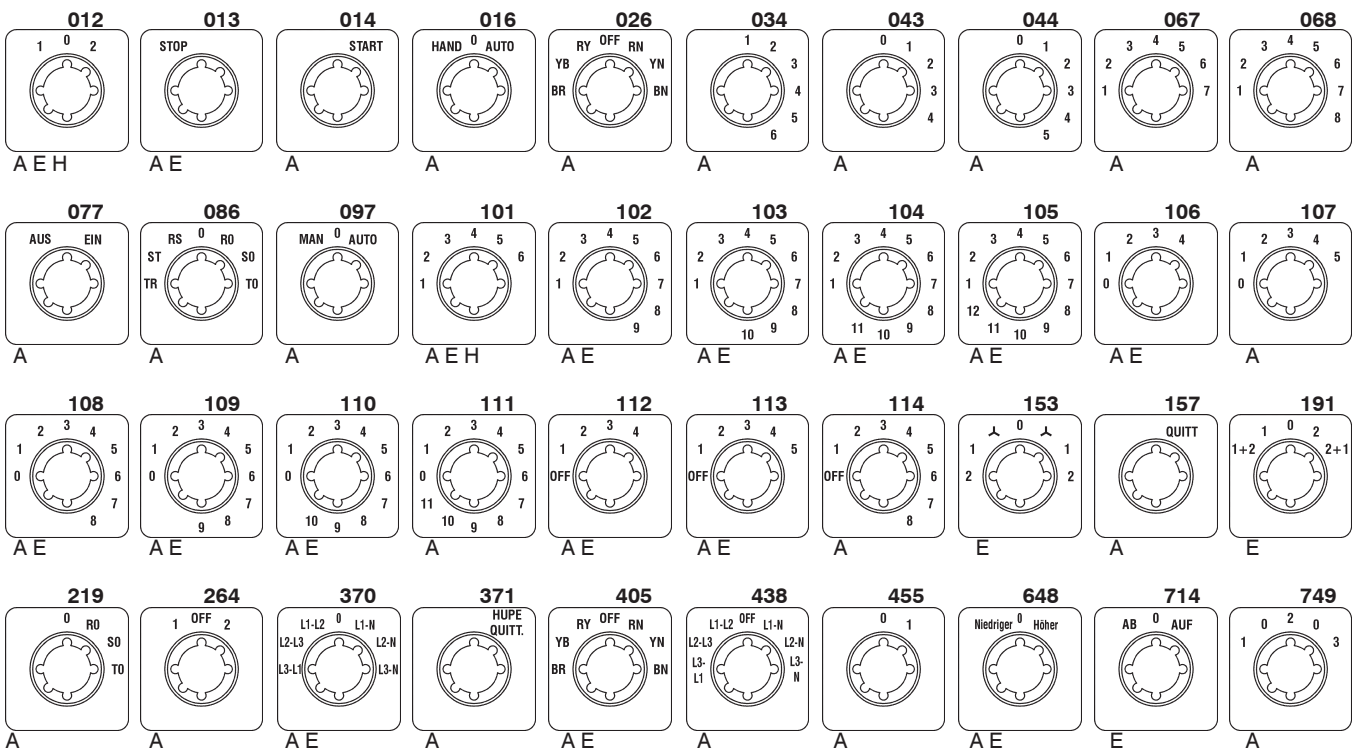

### Switching angle 45°

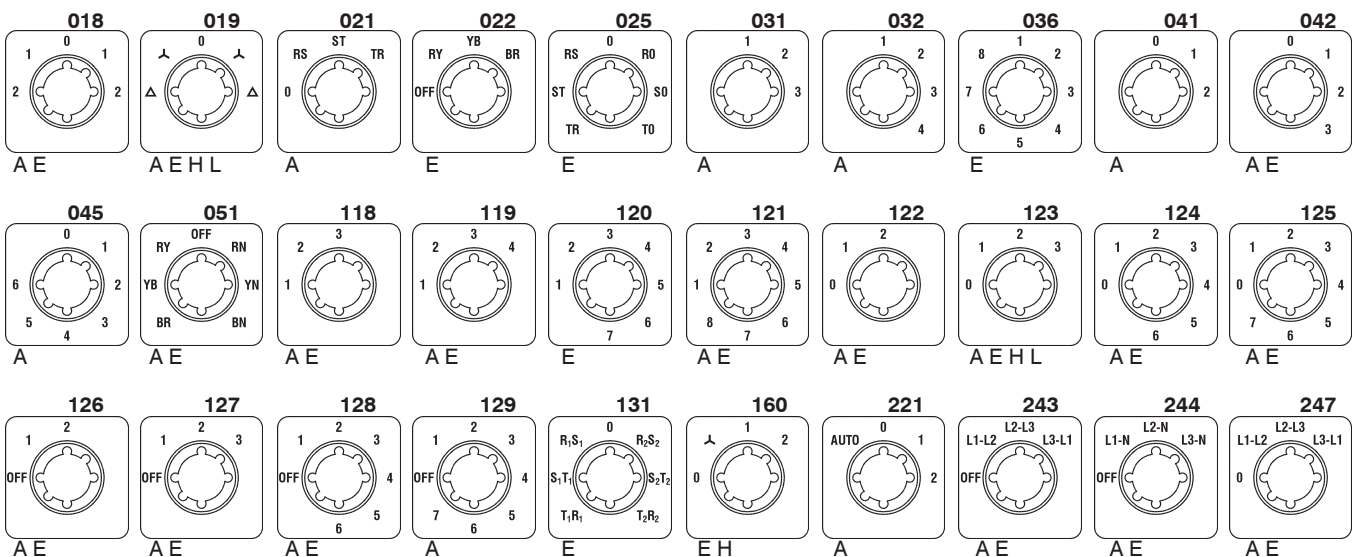

# Escutcheon Plates

## Switching angle 45°

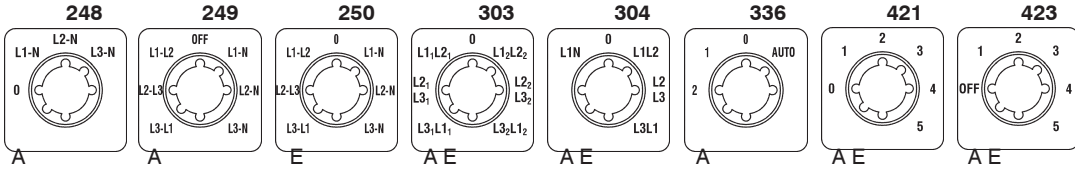

## Switching angle 60°

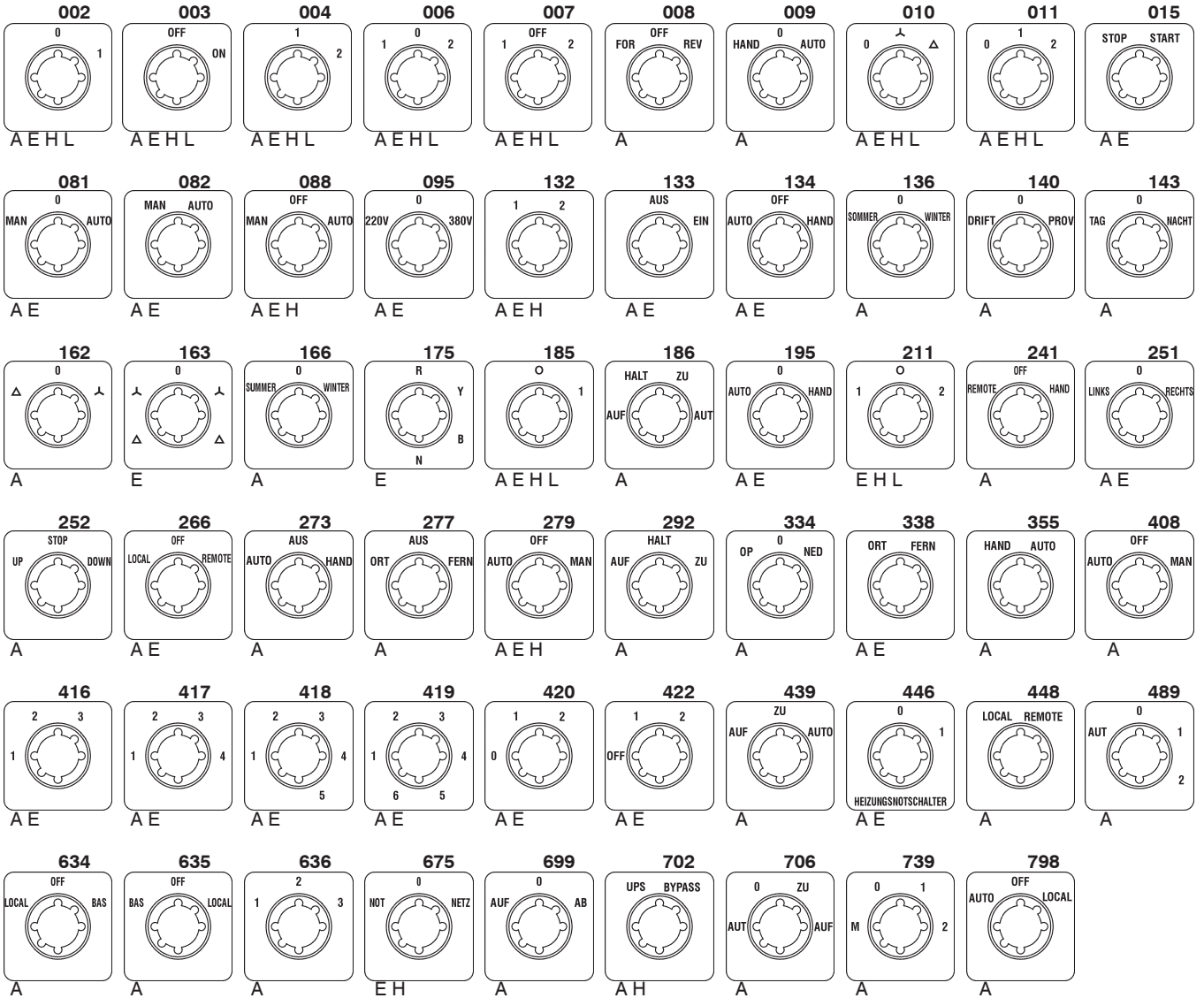

## Escutcheon Plates

Switching angle 90°

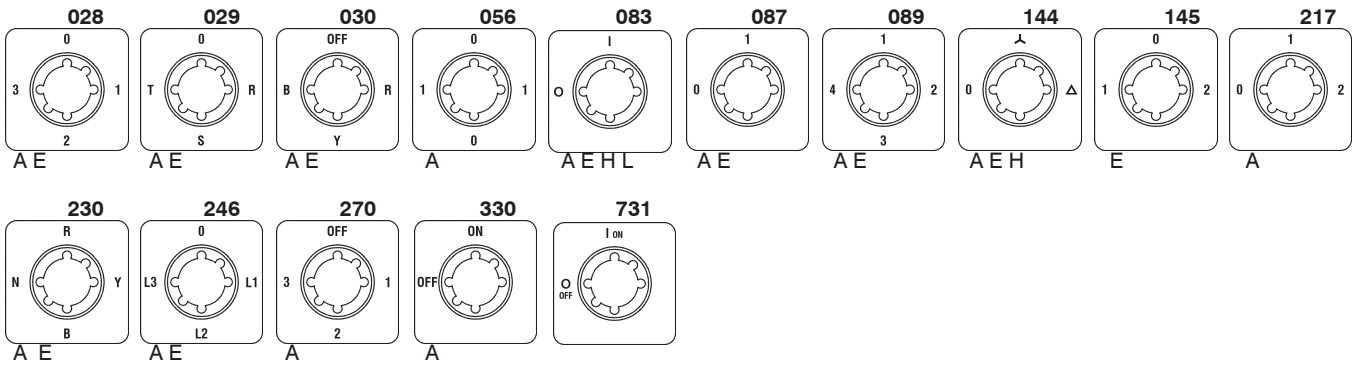

## Miscellaneous

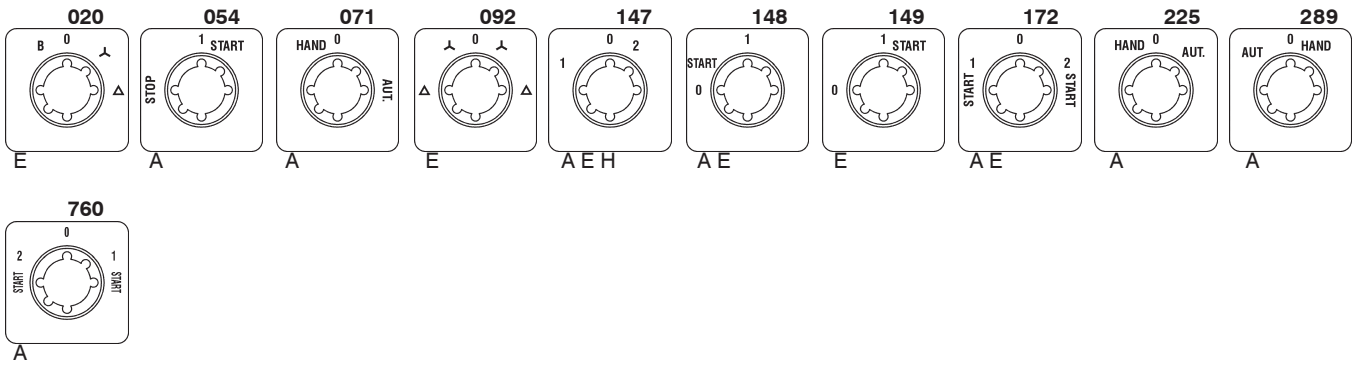

## Rectangular additional escutcheon plates

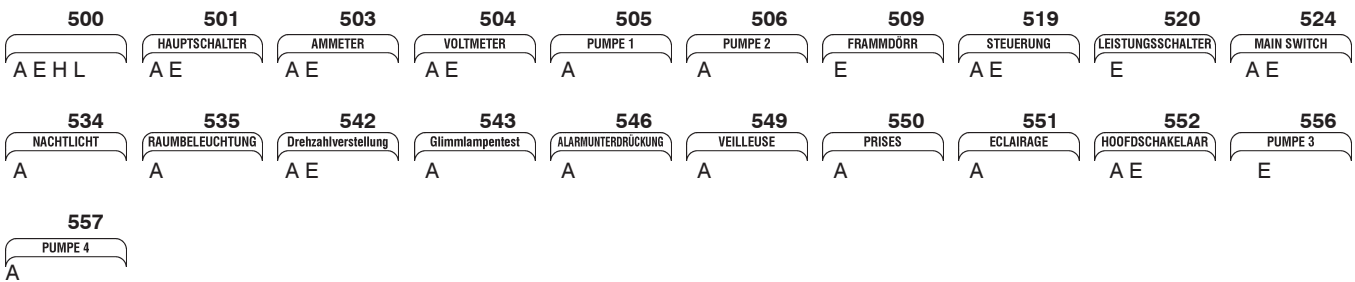

## Covers for design SMA

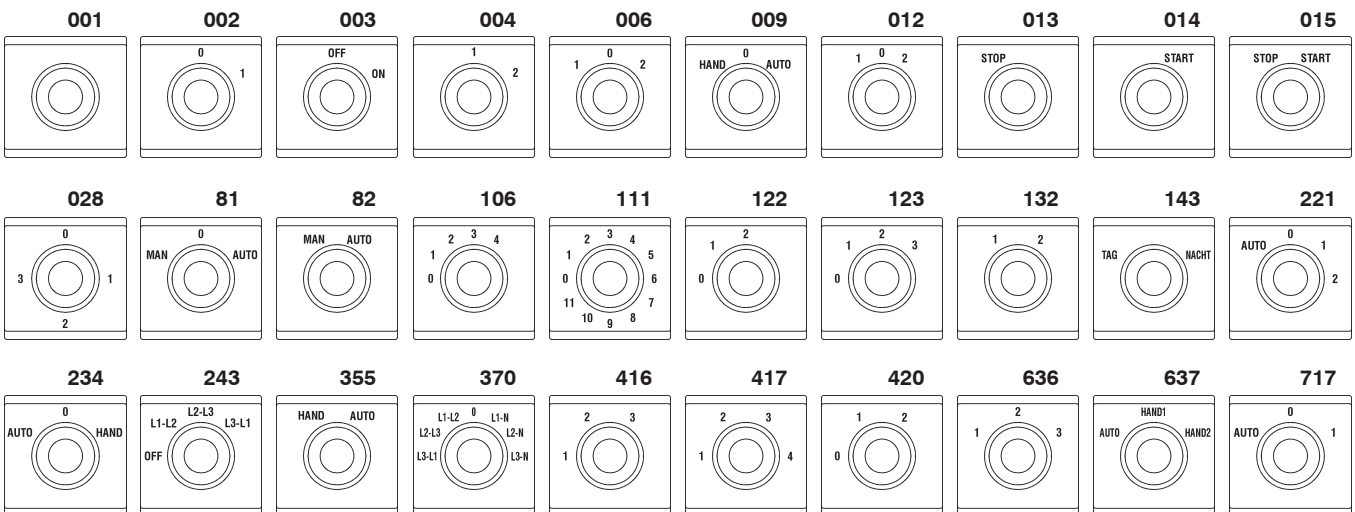

## Switching angles

### Arrangement of switch settings

All feasible arrangements of switch settings are shown, and defined by position numbers, in the following tables. Not only the switching angles, but also switches with latched or momentary settings, or combinations of the two, are distinguished from one another.

Knowledge of the following variations is particularly important when planning special switches. It is necessary to state the position number when ordering special switches, as the cheapest version will otherwise be selected.

All the switches types listed can be supplied with switching angles other than those indicated, provided that they are permitted by the switch program (additional charge).

#### Switching angle 30°

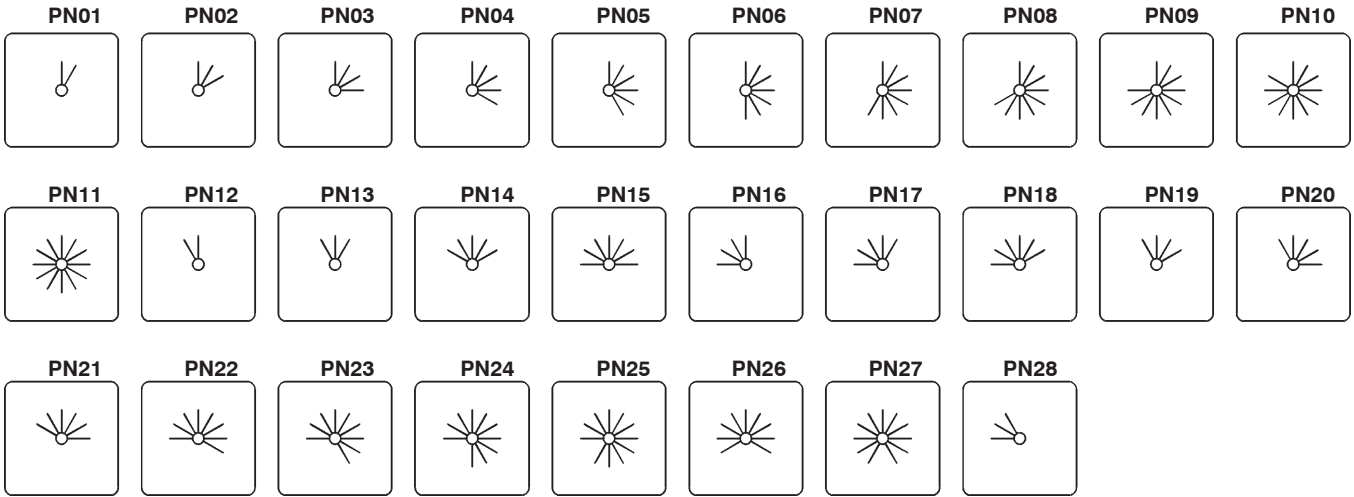

#### Switching angle 45°

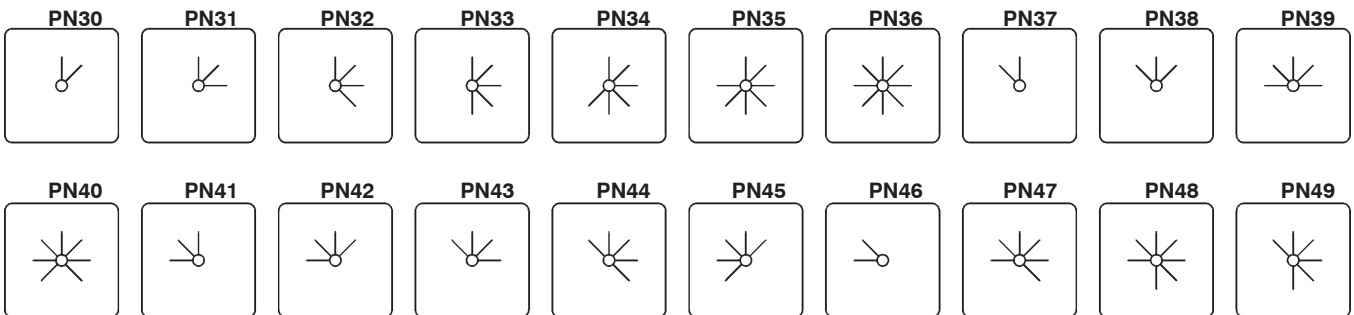

#### Switching angle 60°

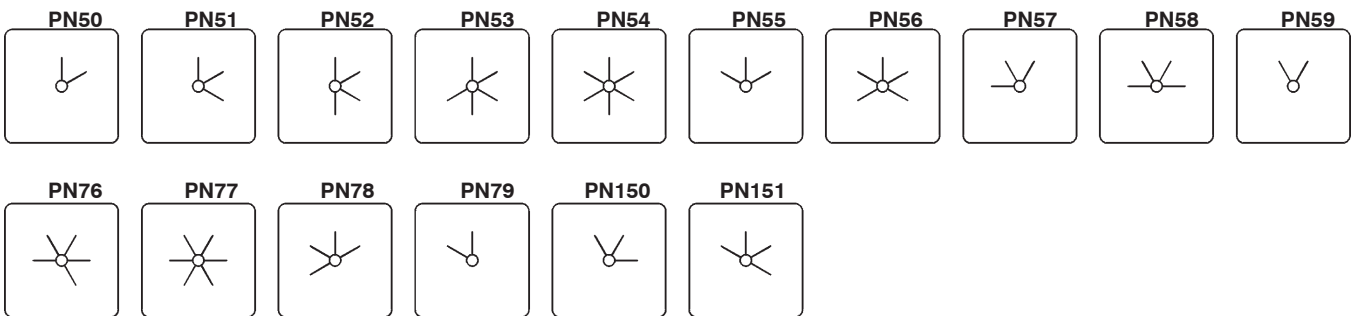

#### Switching angle 45/90°

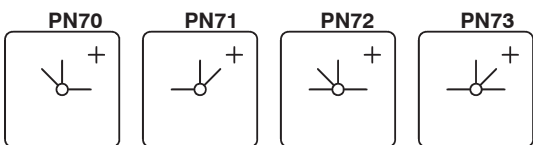

+) Not available for switch types M10, M10H and M20

## Switching angles

### Switching angle 90°

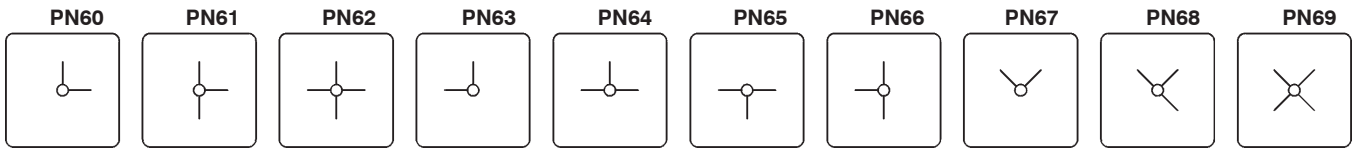

### Momentary settings and special combinations

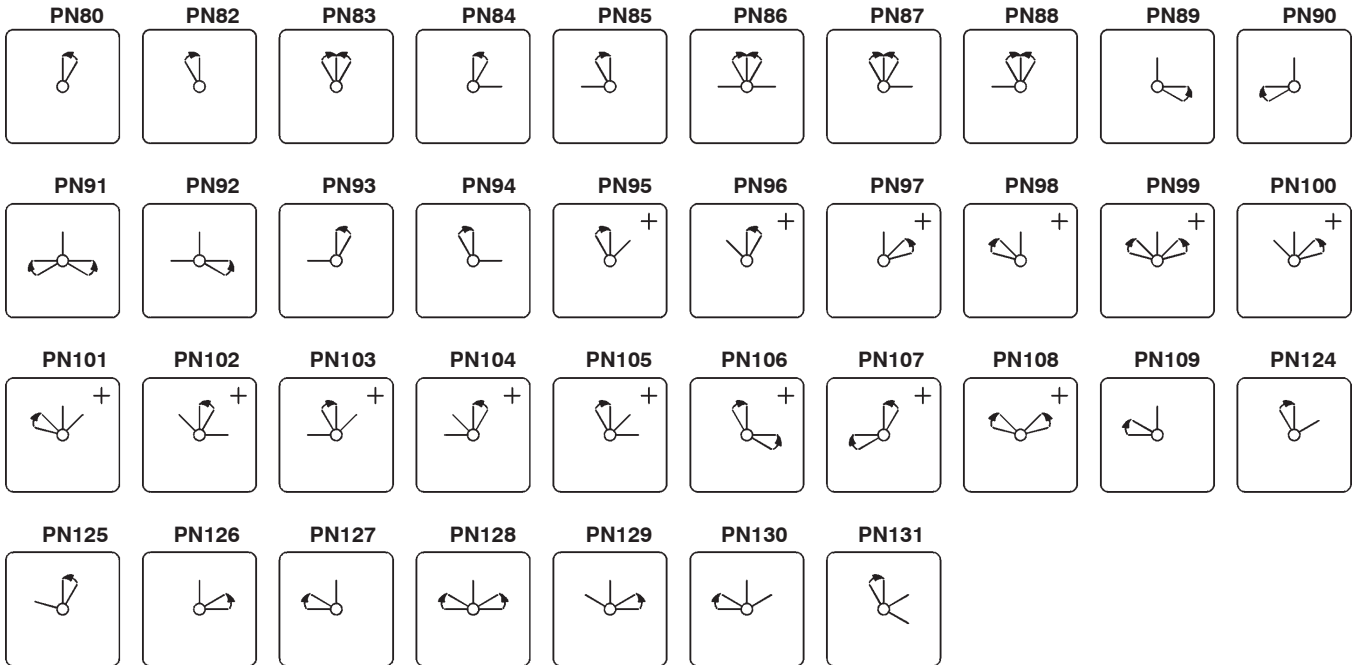

### Spring return over several settings

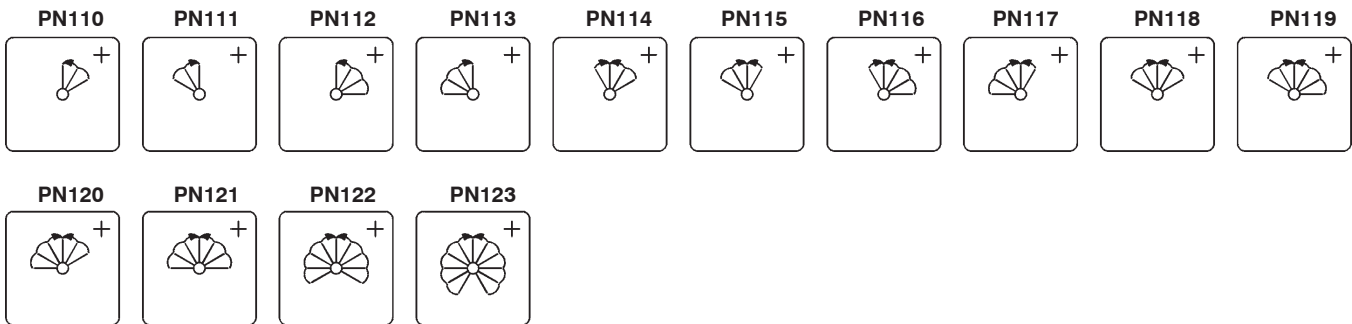

+) Not available for switch types M10, M10H and M20

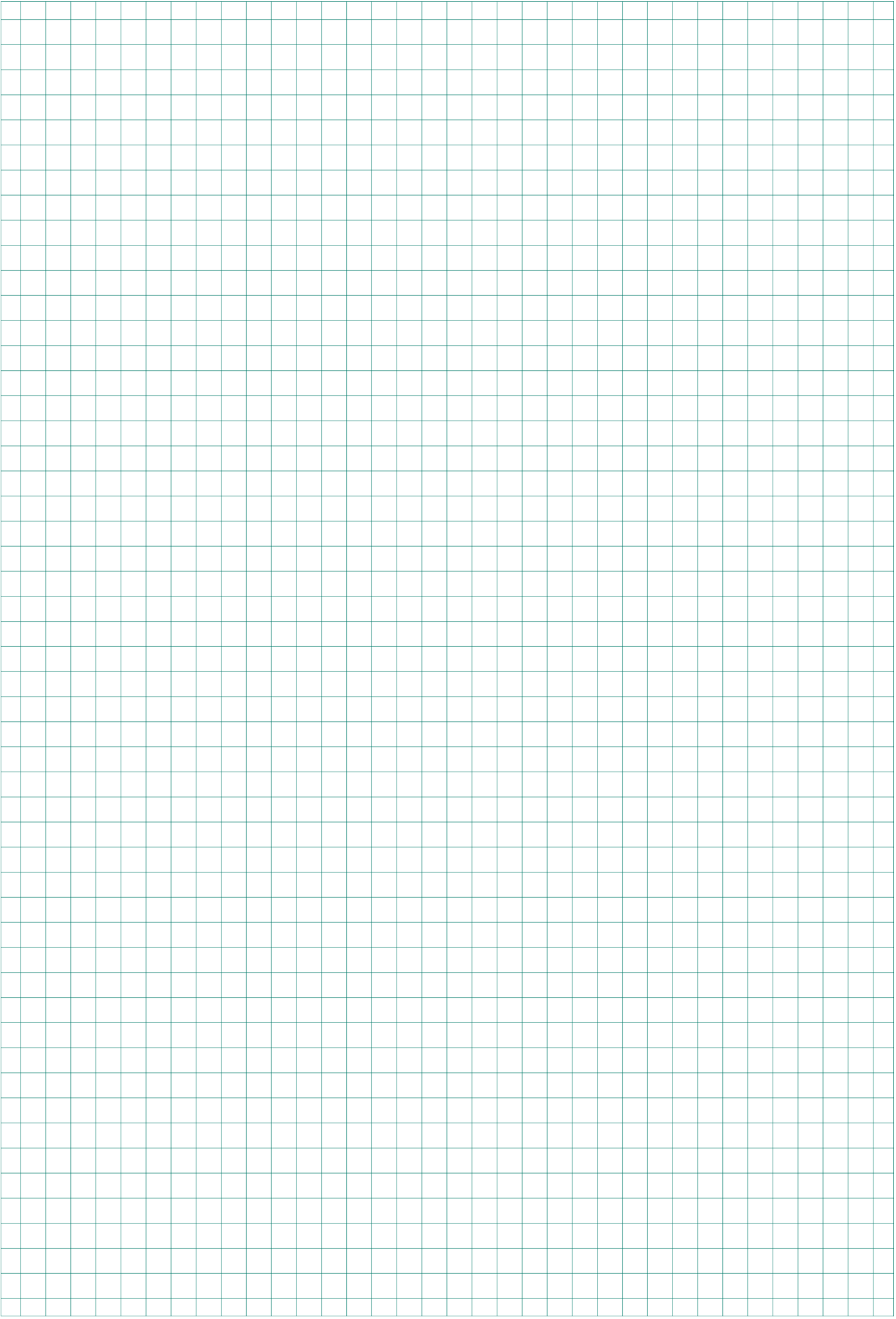

Contactors, Motor-Starter

Circuit Breakers

Manual Motor-Starters

**Switches**

AC-Main Switches

DC-Switch Disconnector

Push Buttons

Representatives, Suppliers

## Door couplings

For switches with door couplings it is necessary to state the installation depth - that is, the distance between mounting level of the switch and the inside edge of the door (dimension T).

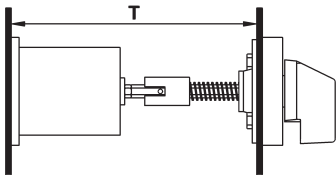

Door couplings are available for switches to be installed in switchgear cabinets or distribution boards with hinged doors. These permit the doors to be opened without removal of the operating knobs.

**Ordering example:** Cam switch N100 V A3 with lockable door coupling, moisture protected IP65, dimension T=580mm  
Order type: **N100 V A3 +TK2FR/580**

**Dimensions** see page 269



	Ordering Code	Suitable for designs	Suitable for switch type
<b>Door coupling</b> Protection class from front: IP65 5-hole mounting	+TKE/...	V, SM	M10H, M10HD, M20, N20, N33F
<b>Door coupling locked</b> Protection class from front: IP65 5-hole mounting Doors only open at a given switch setting: unless otherwise stated, the "OFF" setting.	+TK2E/...	V, SM	M10H, M10HD, M20, N20, N33F
<b>Door coupling locked</b> Protection class from front: IP65 Central fixing Ø22mm Doors only open at a given switch setting: unless otherwise stated, the "OFF" setting.	+TK2Z/...	V, SM	M10H, M10HD, M20, N20, N33F
<b>Door coupling</b> Protection class from front: IP40 5-hole mounting	+TK/...	V	N40, N61, N80, N100, N200 L100, L400, L600 L800
<b>Door coupling</b> Protection class from front: IP54 5-hole mounting	+TKFR/...	V	N40, N60, N80, N100, N200 L100, L400, L600 L800
<b>Door coupling locked</b> Protection class from front: IP40 5-hole mounting Doors only open at a given switch setting: unless otherwise stated, the "OFF" setting.	+TK2/...	V	N40, N61, N80, N100, N200 L100, L400, L600 L800
<b>Door coupling locked</b> Protection class from front: IP54 5-hole mounting Doors only open at a given switch setting: unless otherwise stated, the "OFF" setting.	+TK2FR/...	V	N40, N61, N80, N100, N200 L100, L400, L600 L800

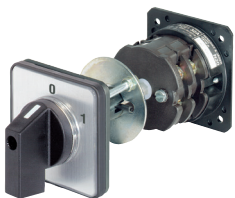
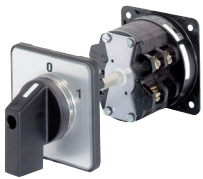

## Lockable switches

Key-operated and lockable switches are supplied with two keys. Additional keys or other types of lock on request.

**Ordering example:** Cam switch N20 E A3 key operated  
Order type: **N20 E A3 +SA**

**Dimensions** see page 270 and 271



**Key operated switch**  
Lock Willenhal FT101, key removable in all lockable settings.  
Other types of lock on request.  
Maximum number of cells  
M10 - N33F: 6 N40, N61, N80: 2  
**Key operated switch**, key removable only in some settings. Add letter of setting where key is removable to ordering code according to the scetch below.

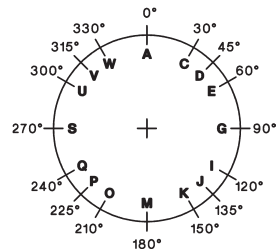

**Key operated switch IP65**  
Lock Ronis R455, key removable in all lockable settings.  
**Key operated switch**, key removable only in some settings. Add letter of setting where key is removable to ordering code according to the scetch above.

**Key operated switch**  
Lock KABA8, key removable in all lockable settings.  
**Key operated switch**, key removable only in some settings. Add letter of setting where key is removable to ordering code according the scetch below.

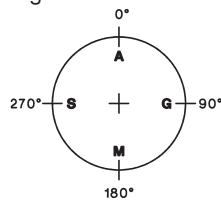



Ordering Code	Suitable for designs	Suitable for switch type
+SA  +SA/.	E, V, SM E, V P SMA UP	M10H, M10HD, M20 N20, N33F, N40, N61, N80 M10, N20, N33F M10H, M10HD, M20 M10
+SA  +SA/.	Z, ZO	M10H, M10HD, M20
+SAK  +SAK/.	E	M10H, M10HD, M20

## Padlock devices

A range of padlock devices designed to prevent from being turned on by unauthorized personnel, or during maintenance and repair work, can be supplied.

**Dimensions** see page 272

**Ordering example:** Cam switch N33F E A3 with interlocking device SV3 suitable for 3 padlocks  
Order type: **N33F E A3 +SV3**

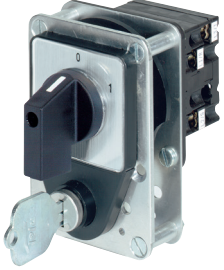
	escut. plate [mm]	Ordering Code	Suitable for designs	Suitable for switch type
	48x48	<b>+SV1 +SV1R</b>	E, V, SM P, PF	M10H, M20 M10
	64x64	<b>+SV164 +SV164R</b>	E, V P, PF	M10H, N20, N33F N20, N33F
	88x88	<b>+SV3 +SV3R</b>	E, V E, V E, V PF	N40, N61, N80 N100, N200, L400, L600, L800, L1200 N40, N61, N80
	132x132	<b>+SV3 +SV3R</b>	E, V E, V E, V PF	N40, N61, N80 N100, N200, L400, L600, L800, L1200 N40, N61, N80
	64x64	<b>+SV4 +SV4R</b>	E, V SM P, PF	M10H, N20, N33F M10H, N20, N33F N20, N33F
	88x88	<b>+SV488 +SV488R</b>	E, V E, V P, PF	N20, N33F N40, N61, N80 N40, N61, N80
		<b>+SZ</b>	E, V SM	all M10H, M20, N20, N33F
		<b>+SZ2</b>	E, V SM	all M10H, M20, N20, N33F

## Switch interlocks

A wide range of locks and interlocking devices, designed to prevent accidental or hazardous switching, can be supplied.

**Ordering example:** Cam switch N20 E A3 with push button switch lock  
Order type: **N20 E A3 +DV**

**Dimensions** see page 273

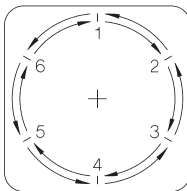

Description	Ordering Code	Suitable for designs	Suitable for switch type
<p><b>Push button interlock</b> The switch can only be actuated when the pushbutton is simultaneously depressed (two-handed operation).</p>	<b>+DV</b>	E, V	all
<p><b>Interlock with electrical contact</b> The switch can only be actuated when the pushbutton, which also operates a make and break contact, is actuated (for external interlocking devices or safety measures).</p>	<b>+ET</b>	E, V	all
<p><b>Magnetic interlock</b> The switch can only be actuated when an electromagnet is simultaneously excited. When ordering, voltage and percentage duty cycle of the magnet coil should be stated.</p>	<b>+MV</b>	E	N20, N33F, N40, N61, N80 N100, N200
<p><b>Circular switch</b> Switches that have the maximum number of settings for a given switching angle can be made without a stop position, permitting direct switching from the last to the first setting.</p>	<b>+RU</b>	all	all

## Couplings and stop mechanism

A range of couplings and stop mechanisms for trouble-free operation of switches with a very large number of contacts can be supplied.

**Dimension** see page 274



Description	Ordering Code	Suitable for designs	Suitable for switch type
<p><b>Coupling of different switch sizes</b> For attachment of control switches (auxiliary contacts) to larger switches. M10H, M20 in sizes E and H. N20 to N80 in size L.</p>	+ZWK	E	N40, N61, N80, L100 N100, N200, L400, L600, L800, L1200
<p><b>Second stop mechanism</b> With switches in which a large number of contacts is simultaneously operated, use of a second stop mechanism is sometimes necessary, in order to ensure precise switching to the next setting.</p>	+RW2	all	all

## Special versions

A number of special versions can be supplied for adaptation of switches to various conditions of use.

**Ordering example:** Cam switch M10H E U3 with large front plate  
Order type: **M10H E U3 +GFP**

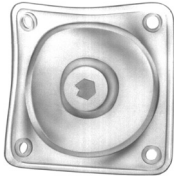

Description	Ordering Code	Suitable for designs	Suitable for switch type
<b>Switch shaft sealing</b> For increased front protection class on IP54.	+WD	E, V SM	N20 to L1200 N20, N33F
<b>Front plate/switch shaft sealing</b> For increased front protection class on IP65. In this version, a wider hole is required for the shaft. Dimensions see page 272	+FPWD	E, V, SM	N20, N33F
<b>Extended switch shaft</b> For adaptation of switch designs V and SM to the enclosure depth. State additional shaft length when ordering.	+VW/...	E, V SM	all M10H, M10HD, M20, N20, N33F
<b>Large front plate</b> Switch with front plate and operating knob of the next size (for replacement of older, larger switches or aesthetic reasons).	+GFP	E, V, SM	M10H, M10HD, N20, N33F
<b>Neon safety switch</b> For all-pole switching off of neon advertisement circuits by the Fire Brigade. Dimensions see page 274	+FEU	E	N20, N33F

## Accessories

A number of special versions can be supplied for adaptation of switches to various conditions of use.

**Dimensions** see page 273

**Ordering example:** Cam switch N20 E A3 with terminal cover plate  
Order type: **N20 E A3 +KLAD**

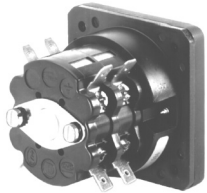
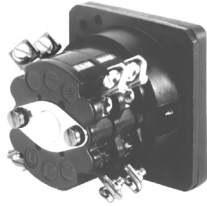

Description	Ordering Code	Suitable for designs	Suitable for switch type
<b>Terminal cover plate</b> Prevents accidental touching of live terminals (requirement for main switches according to VDE 0113) only for 2 cells for all cells	<b>+KLAD</b>	E, V	N20, N40, N61, N80 N100, N200
	<b>+KLAD</b>	E, V	N33
<b>Angled terminals</b> For easy connection of inaccessible switches. Unless otherwise stated, all terminals specified with markings are equipped in this manner. A distinction is drawn between left and right angled terminals. Seen from the switch end, the left terminals are located above left and below right; conversely, right terminals are above right and below left.	<b>+WK</b>	E, V	M20, N20, N40, N61, N80, N100
<b>Fast-on connectors</b> For 6,3 x 0,8mm plugs.	<b>+AMPZ</b>	E, V	M20, N20
<b>Earth terminals</b> 2 terminals, connected with one another, insulated from switch column: for earth conductors.	<b>+PE</b>	E, V, P, PF PF G, GF	all M10, N20, N33F, N40, N61 N80 N20
<b>Additional rectangular escutcheon plate 1 line</b> Dimensions see page 267	<b>SRE</b>	E, Z, V, SM	all
<b>Big additional rectangular escutcheon plate for 2 lines</b> Dimensions see page 267	<b>SRE2</b>	E, V	M10H, M10HD, M20, N20, N33F
<b>Spare key</b> for key operated switches with Lock Willenhal FT101	<b>J7101</b>	E, V, P SMA	M10H, M10HD, M20, N20, N33F, N40 M10H, M10HD, M20
<b>Spare key</b> for key operated switches with Lock Ronis R455	<b>B4-R455</b>	Z, ZO	M10H, M10HD, M20
<b>Wrench</b> for switches with central fixing	<b>J7049</b>	Z, ZO	M10H, M10HD, M20



## Utilization Categories

For easier choice of devices and in order to make the comparison of different products simpler are utilization categories for cam switches according to IEC 947-3, VDE 0660 Part 107 and

auxiliary contacts according to IEC 947-5-1 and VDE 0660 Part 200 determined. The Table below offers diverse utilization categories and assorted test conditions.

Kind of current	Category		Typical applications	Rated operational current	Test conditions for the number of on-load operating cycles (normal service)						Test conditions for making and breaking capacities (operation in fault case)					
	fre-quent operation	infre-quent operation			Make			Break			Make			Break		
					I/I <sub>e</sub>	U/U <sub>e</sub>	cosφ	I/I <sub>e</sub>	U <sub>r</sub> /U <sub>e</sub>	cosφ	I/I <sub>e</sub>	U/U <sub>e</sub>	cosφ	I/I <sub>e</sub>	U <sub>r</sub> /U <sub>e</sub>	cosφ
Alternating Current	AC20A	AC20B	No-load conditions	all values	-	-	-	-	-	-	-	-	-	-	-	-
	AC21A	AC21B	Switching of resistive loads including moderate overloads	all values	1	1	0,95	1	1	0,95	1,5	1,05	0,95	1,5	1,05	0,95
	AC22A	AC22B	Switching of mixed resistive and inductive loads including moderate overloads	all values	1	1	0,8	1	1	0,8	3	1,05	0,65	3	1,05	0,65
	AC23A	AC23B	Switching of motor loads or other highly inductive loads	0 < I <sub>e</sub> ≤ 100A all values 100A < I <sub>e</sub>	1	1	0,65	1	1	0,65	10	1,05	0,45	8	1,05	0,45
	AC2		Slip-ring motors: Starting, plugging	all values	2,5	1	0,65	2,5	1	0,65	4	1,05	0,65	4	1,05	0,65
	AC3		Squirrel-cage motors: Starting, switching off motors during running	0 < I <sub>e</sub> ≤ 100A all values 100A < I <sub>e</sub>	I <sub>e</sub> ≤ 17A 6 1 I <sub>e</sub> > 17A	0,65	I <sub>e</sub> ≤ 17A 1 0,17 I <sub>e</sub> > 17A	0,65	10	1,05	0,45	8	1,05	0,35	0,45	0,35
	AC4		Squirrel-cage motors: Starting, plugging, inching	0 < I <sub>e</sub> ≤ 100A all values 100A < I <sub>e</sub>	I <sub>e</sub> ≤ 17A 6 1 I <sub>e</sub> > 17A	0,65	I <sub>e</sub> ≤ 17A 6 1 I <sub>e</sub> > 17A	0,65	12	1,05	0,35	10	1,05	0,35	0,45	0,35
	AC15		Control of electromagnetic loads (> 72VA)	-	10	1	0,7	1	1	0,4	10	1,1	0,3	10	1,1	0,3
					I/I <sub>e</sub>	U/U <sub>e</sub>	L/R <sup>1)</sup>	I/I <sub>e</sub>	U <sub>r</sub> /U <sub>e</sub>	L/R <sup>1)</sup>	I/I <sub>e</sub>	U/U <sub>e</sub>	L/R <sup>1)</sup>	I/I <sub>e</sub>	U <sub>r</sub> /U <sub>e</sub>	L/R <sup>1)</sup>
Direct current	DC20A	DC20B	No-load conditions	all values	-	-	-	-	-	-	-	-	-	-	-	-
	DC21A	DC21B	Switching of resistive loads including moderate overloads	all values	1	1	1	1	1	1	1,5	1,05	1	1,5	1,05	1
	DC22A	DC22B	Switching of mixed resistive a. induct. loads incl. moderate overloads (shunt motors)	all values	1	1	2	1	1	2	4	1,05	2,5	4	1,05	2,5
	DC23A	DC23B	Switching of highly inductive loads (e.g. series motors)	all values	1	1	7,5	1	1	7,5	4	1,05	15	4	1,05	15
	DC3		Shunt-motors: Starting, plugging, inching	all values	2,5	1	2	2,5	1	2	4	1,05	2,5	4	1,05	2,5
	DC5		Series-motors: Starting, plugging, inching	all values	2,5	1	7,5	2,5	1	7,5	4	1,05	15	4	1,05	15

U<sub>e</sub> Rated operational voltage, U Voltage before make, U<sub>r</sub> Recovery voltage, I<sub>e</sub> Rated operational current, I Current made, I<sub>c</sub> Current broken  
1) Time in milliseconds (ms)

Note:  
By plugging, is understood stopping or reversing the motor rapidly by reversing motor primary connections while the motor is running.  
By inching (jogging), is understood energizing a motor once or repeatedly for short periods to obtain small movements of the driven mechanism.

## Technical Data

Data according to IEC 947-3, IEC 947-5-1, VDE 0660, EN 60947-3, EN 60947-5-1

Type	M10 P	M10H	M10HD	M20	N20	N33F	N40	N61	N80	N100	N200
Rated therm. current $I_{th}$ open A	20	20	10	32	32	50	63	90	115	150	250
Rated therm. current $I_{the}$ encl. A	20	20	10	32	32	50	63	90	115	150	250
Rated operational voltage $U_e$ V	440	690 <sup>1)</sup>	690 <sup>1)</sup>	690 <sup>1)</sup>	690 <sup>1)</sup>	690 <sup>1)</sup>	690 <sup>1)</sup>	690 <sup>1)</sup>	690 <sup>1)</sup>	690 <sup>1)</sup>	690 <sup>1)</sup>
Disconnection property <sup>2)</sup> acc. to VDE, IEC up to V	440	440	- <sup>4)</sup>	440	440	440	690	440	440	690	690
<b>Breaking capacity <math>I_{eff}</math></b>											
3 x 220-440V A	160	160	35	220	220	260	380	520	740	900	1100
3 x 500V A	-	100	-	160	160	200	290	380	560	680	850
3 x 660-690V A	-	80	-	120	120	150	200	290	520	450	-
<b>Utilization categ. AC21A, AC21B</b> Switching of resistive loads including moderate overloads											
Rated operational current $I_e$ A	20	20	10	32	32	50	63	90	115	150	250
<b>Utilization categ. AC23A, AC23B</b> Switching of motor loads or other highly inductive loads											
Rated current $I_e$ 400V A	16	16	3,5	30	30	45	45	60	85	105	135
Power rating 220-240V kW	4	4	0,75	7,5	7,5	11	15	22	30	40	40
3-phase 3-pole 380-440V kW	7,5	7,5	1,5	15	15	22	22	30	45	55	70
500V kW	-	7,5	1,5	15	15	22	22	30	45	55	70
660-690V kW	-	7,5	1,5	15	15	22	18,5	30	45	45	-
<b>Star-Delta-Switches</b> for squirrel cage motors											
Power rating 3-phase 3-pole 220-240V kW	3,7	3,7	-	7,5	7,5	8	11	15	18,5	37	40
380-415V kW	7,5	7,5	-	15	15	18,5	18,5	25	30	40	70
<b>Utilization category AC3</b> Switching of three-phase motors											
Rated current $I_e$ 400V A	12	12	2	22	22	30	30	50	60	80	135
Power rating 220-240V kW	3	3	0,37	5,5	5,5	7,5	7,5	15	18,5	25	40
3-phase 3-pole 380-440V kW	5,5	5,5	0,75	11	11	15	15	25	30	40	70
500V kW	-	5,5	0,75	11	11	15	15	25	30	40	70
660-690V kW	-	5,5	0,75	11	11	15	15	25	30	40	70
<b>Utilization category AC4</b> squirrel cage motors, inching											
Power rating 220-240V kW	0,55	0,55	-	2,2	2,2	3,7	4	5,5	6	11	18,5
3-phase 3-pole 380-440V kW	1,5	1,5	-	4	4	5,5	7,5	11	15	18,5	35
500V kW	-	1,5	-	4	4	5,5	7,5	11	15	22	35
660-690V kW	-	1,5	-	4	4	5,5	7,5	11	15	22	-
<b>Utilization category AC15</b> Control of electromagnetic loads, contactors,											
Rated current $I_e$ up to 240V A	6	6	2,5	12	12	16	-	-	-	-	-
380 - 440V A	4	4	1,5	6	6	7	-	-	-	-	-
2-pole in series 500V A	-	5	-	8	8	10	-	-	-	-	-
<b>Utilization categ. DC21A, DC21B</b> Switching of resistive loads											
Time constant $L/R \leq 1ms$											
Rated current $I_e$ 1-pole 30V A	20	20	10	32	32	40	63	80	100	150	250
60V A	4	4	-	6	6	20	30	30	30	-	-
110V A	0,6	0,6	-	3	3	4	6	6	6	-	-
220V A	0,5	0,5	-	0,8	0,8	0,8	1,3	1,3	1,3	2,5	2,5
440V A	-	-	-	0,4	0,4	0,4	0,6	0,6	0,6	0,7	0,7
<b>Utilization category DC3 - DC5</b> Switching of shunt motors and series motors											
Time constant $L/R \leq 15ms$											
Rated current $I_e$ 1-pole 30V A	8	8	-	13	13	16	25	32	40	60	100
60V A	1	1	-	2,4	2,4	4	12	12	12	-	-
110V A	0,3	0,3	-	0,5	0,5	1,6	2,4	2,4	2,4	-	-
Protection class of terminals <sup>1)</sup>	IP00	IP20	IP20	IP00	IP00	IP20	IP00	IP00	IP00	IP00	IP00

1) suitable for: earthed-neutral systems, overvoltage category I to III, pollution degree 3 (standard-industry):  $U_{imp} = 6kV$ . Data for other conditions on request

2) valid for lines with grounded common neutral termination, overvoltage category III, pollution degree 3.

3) Protection degree of the terminals with connected insulated conductor. Additional protection with terminal cover (KLAD).

4) Fulfil the requirements acc. to load switches.

## Technical Data

Data according to IEC 947-3, IEC 947-5-1, VDE 0660, EN 60947-3, EN 60947-5-1

Type		M10 P	M10H	M10HD	M20	N20	N33F	N40	N61	N80	N100	N200
<b>Cable cross-sections</b>												
solid	mm <sup>2</sup>	1-2,5	1-2,5 <sup>1)</sup>	1-2,5 <sup>1)</sup>	1,5-6	1,5-6	2,5-10	2,5-16 <sup>1)</sup>	6-25 <sup>1)</sup>	6-35	10-50 <sup>1)</sup>	50-150
flexible	mm <sup>2</sup>	0,75-2,5	0,75-2,5 <sup>1)</sup>	0,75-2,5 <sup>1)</sup>	1-4	1-4	1,5- 6	2,5-10 <sup>1)</sup>	6-25 <sup>1)</sup>	6-35	10-35 <sup>1)</sup>	35-120
flexible w. multicore cable end	mm <sup>2</sup>	0,75-2,5	0,75-1,5	0,75-1,5	1-4	1-4	1,5- 6	2,5-6	6-16	6-35	10-25	-
Conductors to clamp per pole		2	2	2	2	2	2	2	1	1	1	1
Size of terminal screw		M3	M3,5	M3,5	M4	M4	M4	M5	2xM5	2xM5	2xM6	M10
Tightening torque	Nm lb.inch	0,6-1,2 5-11	0,8-1,4 7-12	0,8-1,4 7-12	1,2-1,8 11-16	1,2-1,8 11-16	1,2-1,8 11-16	2,5-3 22-26	2,5-3 22-26	2,5-3 22-26	3,5-4,5 31-40	23 202
<b>Short circuit protection</b>												
Max. fuse size	gL (gG) A	20	20	20	35	35	50	63	100	125	160	250
Rated short-time withstand current (1sec. current)	A	250	250	-	400	400	500	800	1000	1400	1800	3000
Rated conditional short-circuit current	kA <sub>eff</sub>	10	10	1	10	10	10	10	10	10	10	10
<b>Short-time capacity</b>												
Load duration	3s A	100	100	-	200	200	350	400	600	720	1000	2000
	10s A	60	60	-	130	130	230	250	400	480	600	1200
Note: Ratings applies to contacts already closed	30s A	35	35	-	85	85	110	160	250	300	500	600
	60s A	25	25	-	65	65	80	110	200	250	370	480
<b>Power loss at AC21A</b>												
per pole	A W	20 0,6	20 0,5	10 0,5	32 0,9	32 1,1	50 1,9	63 2	85 2,8	115 4,4	150 5,7	250 21
<b>Switching of capacitive loads</b>												
maximum making capacity up to 500V	A	140	140	-	300	300	350	400	600	700	900	1800

## Data according to UL and cUL

Type		M10 P	M10H	M10HD	M20	N20	N33F	N61	N80	N100	N200	L400
Rated voltage	V~	300	600	600	600	600	600	600	600	600	600	600
Rated operational current "General Use" with jumper	A A	20 15	20 -	5 -	35 25	35 25	60 40	90 80	115/125 <sup>3)</sup> 80/125 <sup>3)</sup>	130 -	250 -	350 -
DOL-Rating 3-phase	110-120V hp 200-208V hp 220-240V hp	1½ 2 3	1½ 2 3	- - -	5 5 5	5 5 5	7½ 10 15	8½ 12½ 17	10 15 20	15 25 30	15 25 30	15 25 30
	440-480V hp 550-600V hp	- -	5 7½	- -	10 15	10 15	25 30	35 40	40 50	40 50	60 75	60 75
DOL-Rating 1-phase (2-pole break)	110-120V hp 200-208Vhp 1 220-240V hp	½ 1 1½	½ - 1½	- 3 -	1½ 3 5	1½ 5 5	3 6½ 7½	4 7½ 8	5 15 10	7½ 15 15	7½ 15 20	7½ 15 20
Fuse size (RK5) Man. Motor Controller 5kA / 600V and Motor Disconnect	A	40 <sup>2)</sup>	40	-	80	80	150	150	200	300	350	350
Heavy pilot duty	AC	A300	A600	B600	A600	A600	A600	A600	A600	A600	A600	A600
<b>Cable cross sections</b>												
solid	AWG	12 - 20	12 - 20	12 - 20	10 - 18	10 - 18	10 - 12	10 - 12	10 - 12	10 - 14	-	-
flexible	AWG	14 - 20	14 - 20	14 - 20	8 - 18	8 - 18	6 - 12	2 - 12	2/1 <sup>3)</sup> - 12	1 - 14	250kcmil	500kcmil
Tightening torque	Nm lb.inch	1-1.2 9-11	1-1.4 9-13	1-1.4 9-13	1.7-1.8 15-16	1.7-1.8 15-16	1.2-1.8 11-16	2.8 25	2.8 25	4.5 40	23 202	40 352

1) Maximum cable cross-section with prepared conductor

2) 5kA / 300V

3) Increased rated operational current 125A "General Use" and "with jumper" with AWG 1. Add suffix + WK.

## Technical Data

Data according to IEC 947-3, IEC 947-5-1, VDE 0660, EN 60947-3, EN 60947-5-1

Type		L100	L400	L600	L800	L1200
Rated insulation voltage $U_i$	V	690 <sup>2)</sup>	690 <sup>2)</sup>	690 <sup>2)</sup>	690 <sup>2)</sup>	690 <sup>2)</sup>
Rated thermal current $I_{th}$ openA	125	180	600	800	1200	
Rated thermal current $I_{the}$ encl. A	125	180	600	800	1200	
with conductor	mm <sup>2</sup>	50	busbar 40x5	busbar 40x10	busbar 2x40x10	busbar 2x50x10
<b>Utilization category AC21A, AC21B</b>						
Switching of resistive loads, including moderate overloads						
Rated operational current $I_o$	A	125	400	400	400	400
<b>Shot-time current-carrying capacity</b>						
Load duration	1s	-	4800	6500	8500	10000
	3s	800	3600	5000	6500	8000
	10s	500	2000	3200	4000	5800
Note: Ratings applies to contacts already closed	30s	320	1200	1700	2200	3200
	60s	180	960	1300	1700	2300
<b>Cable cross-sections</b>						
solid or stranded	mm <sup>2</sup>	25-50 <sup>1)</sup>	busbar	busbar	busbar	busbar
flexible	mm <sup>2</sup>	25-50 <sup>1)</sup>	40x5	40x10	2x40x10	2x50x10
flexible with multicore cable end	mm <sup>2</sup>	25-35	-	-	-	-
Number of conductors to clamp per pole		1	1	2	1	1
Size of terminal screw		2xM5	M12	M16	M16	M16
Tightening torque	Nm	3	40	98	98	98
	lb.inch	26	352	862	862	862
<b>Short circuit protection</b>						
Max. fuse size	slow, gL (gG) A	125	400	630	800	1250

1) Maximum cable cross-section with prepared conductor

2) suitable for: earthed-neutral systems, overvoltage category I to III, pollution degree 3 (standard-industry):  $U_{imp} = 6kV$ .  
Data for other conditions on request

## Mechanical Life

Schwitich type		M10, M10H	M20, N20, N33F	N40, N60, N80	N100, N200
Operations	x10 <sup>3</sup>	300	250	200	150

Note: The minimum mechanical and electrical life is defined according to IEC/EN60946-3 (approx. 10.000 operations).

## Dimensions (mm)

### Panel mounting E M10 - N100

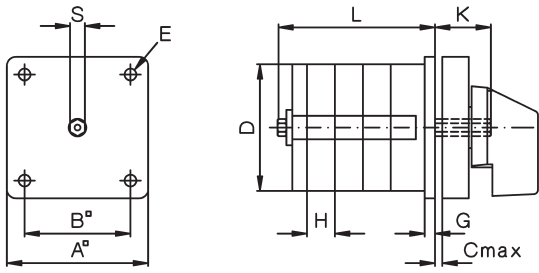

### N200

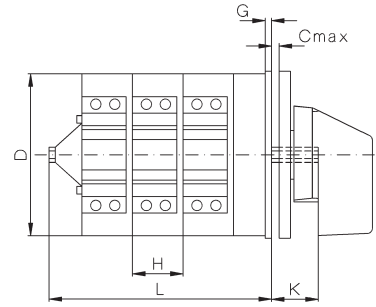
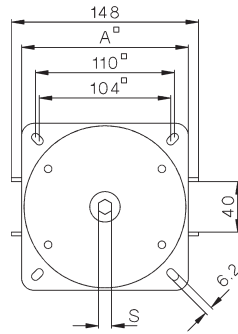

Type	A	B	C	D	D1	D2	D3	E	G	H	K	S
M10H	48	36	5	44 <sup>1)</sup>	5	8	-	4	3,5	9,5	19	SW5
M20	48	36	5	56	5	8	-	4	3,5	12,5	19	SW5
N20	64	48	5	56	5	12	57	4,2	3	12,5	20	SW7
N33F	64	48	5	58 <sup>2)</sup>	5	12	-	4,2	3	15,5	20	SW7
N40	86	68	7	80	6	12	82	5,2	3,5	18	24,5	SW9
N61	86	68	7	80	6	12	82	5,2	3,5	29,5	24,5	SW9
N80	86	68	7	80	6	12	82	5,2	3,5	29,5	24,5	SW9
N100	132	110	9	128	7	16	129	6,2	5	30	37	SW12
N200	132	110	9	128	7	16	-	6,2	5	40	37	SW12

1) 44,5 x 42

2) 58 x 58

Mounting holes: built in from rear  
Mounting screw: J3631N M=1,2-1,4 Nm

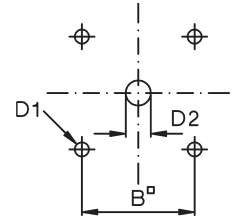

Mounting holes: built in from front

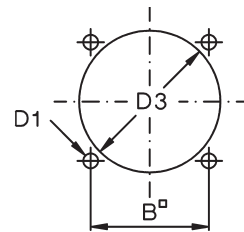

Type	Dimension L with .. cells														
	1	2	3	4	5	6	7	8	9	10	11	12	13	14	15
M10H	36,5	46	55,5	65	74,5	84	93,5	103	112,5	122	131,5	141	-	-	-
M20	38,5	51	63,5	76	88,5	101	113,5	126	138,5	151	163,5	176	-	-	-
N20	40,5	53	65,5	78	90,5	103	115,5	128	140,5	153	165,5	178	190,5	203	215,5
N33F	44	59,5	75	90,5	106	121,5	137	152,5	168	183,5	199	214,5	230	245,5	261
N40	52,5	70,5	88,5	106,5	124,5	142,5	160,5	178,5	196,5	214,5	232,5	250,5	268,5	286,5	304,5
N61	64	93,5	123	152,5	182	211,5	241	270,5	300	329,5	359	388,5	-	-	-
N80	64	93,5	123	152,5	182	211,5	241	270,5	300	329,5	359	388,5	-	-	-
N100	88	118	148	178	208	238	268	298	328	358	388	418	-	-	-
N200	96	136	176	216	256	296	336	376	416	456	496	536	-	-	-

### Central fixing Z M10H, M20, N33F

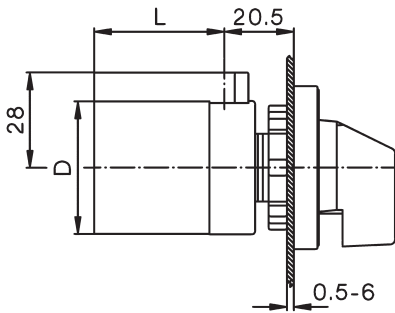

### Central fixing without escutcheon plate ZO M10H, M20

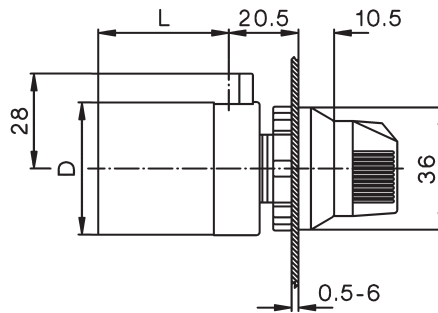

Mounting hole:

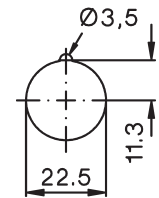

Further dimensions see tables above

### Mini-Cam Switches M4H

#### Panel mounting E

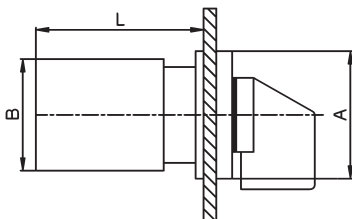

#### Central fixing Z, ZO

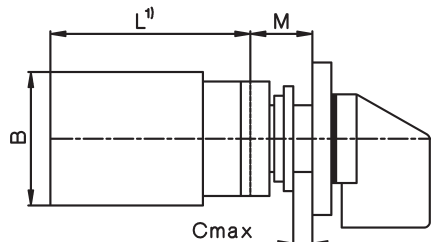

#### ZO

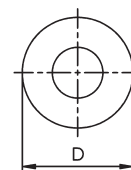

#### Z

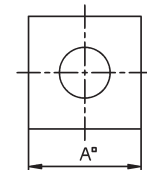

Typ	mm	Dimension L with .. cells											
		A	B	D	M	1	2	3	4	5	6	7	8
M4H		30	28	29,5	12,5	38,5	50,5	62,5	74,5	86,5	98,5	110,5	122,5

Mounting holes see page 236

## Dimensions (mm)

### Flush mounting UP M10

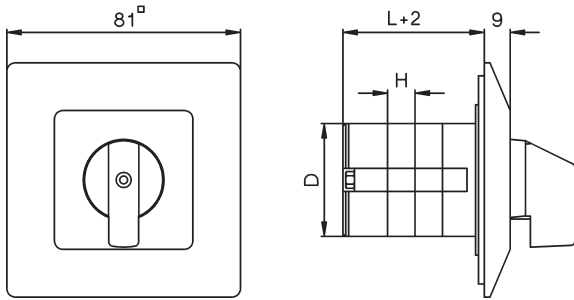

### Base mounting V M10H - N100

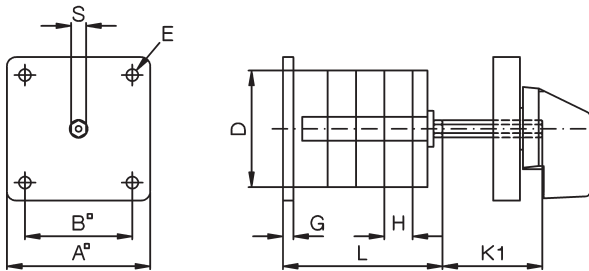

### N200

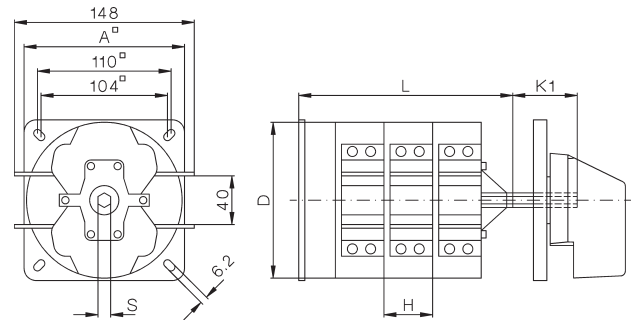

Type	A	B	D	D1	D2	E	G	H	I	K	K1	
M10	48	36	39	5	8	4	3,5	9,5	6	19	41	SW5
M10H	48	36	44 <sup>1)</sup>	5	8	4,2	3	9,5	6	19	41	SW5
M20	48	36	56	5	8	4,2	3	12,5	6	19	47	SW5
N20	64	48	56	5	12	4,2	3	12,5	0	20	29	SW7
N33F	64	48	58 <sup>2)</sup>	5	12	4,2	3	15,5	0	20	31,5	SW7
N40	86	68	80	6	12	5,2	3,5	18	-	-	38,5	SW9
N61	86	68	80	6	12	5,2	3,5	29,5	-	-	49,5	SW9
N80	86	68	80	6	12	5,2	3,5	29,5	-	-	49,5	SW9
N100	132	110	128	7	16	6,2	5	30	-	-	79,5	SW12
N200	132	110	128	7	16	6,2	5	40	-	-	104	SW12

Mounting holes: for escutcheon plate

1) 42 x 44,5

2) 58 x 58

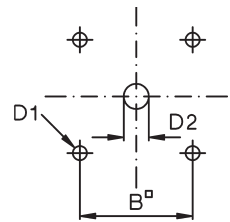

Type	Dimensions L with .. cells														
	1	2	3	4	5	6	7	8	9	10	11	12	13	14	15
M10	34,5	44	53,5	63	72,5	82	91,5	101	110,5	120	129,5	139	-	-	-
M10H	36,5	46	55,5	65	74,5	84	93,5	103	112,5	122	131,5	141	-	-	-
M20	38,5	51	63,5	76	88,5	101	113,5	126	138,5	151	163,5	176	-	-	-
N20	40,5	53	65,5	78	90,5	103	115,5	128	140,5	153	165,5	178	190,5	203	215,5
N33F	44	59,5	75	90,5	106	121,5	137	152,5	168	183,5	199	214,5	230	245,5	261
N40	52,5	70,5	88,5	106,5	124,5	142,5	160,5	178,5	196,5	214,5	232,5	250,5	268,5	286,5	304,5
N61	64	93,5	123	152,5	182	211,5	241	270,5	300	329,5	359	388,5	-	-	-
N80	64	93,5	123	152,5	182	211,5	241	270,5	300	329,5	359	388,5	-	-	-
N100	88	118	148	178	208	238	268	298	328	358	388	418	-	-	-
N200	96	136	176	216	256	296	336	376	416	456	496	536	-	-	-

### Snap-on mounting SM M10H - N33F for 35mm DIN-rail mounting according to DIN EN 50022

Dimensions see tables above

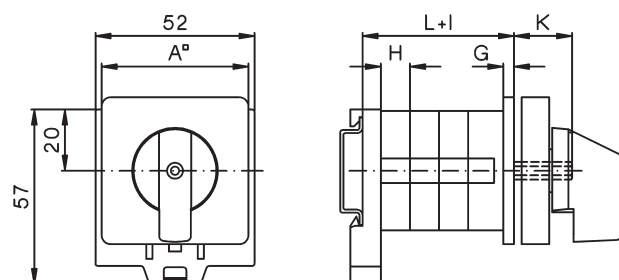

### Switch with installation cover SMA M10H, M20 for 35mm DIN-rail mounting according to DIN EN 50022

Type	Dimension X with .. cells						Dimension Y with .. cells					
	1, 2	3	4	5	6		1, 2	3	4	5	6	
M10H	44	44	72,5	72,5	72,5		60	60	88,5	88,5	88,5	
M20	44	61	76	76	76		60	75	90	90	90	

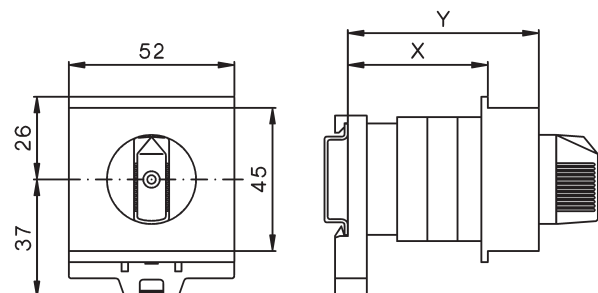

## Dimensions (mm)

### Plastic enclosed switches P, PF M10 - N61

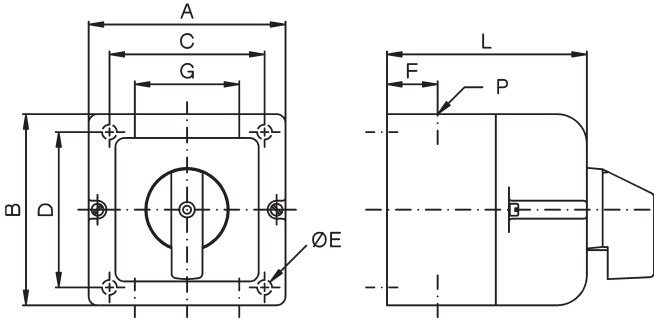

Type	A	B	C	D	E	F	G	P	Dimension L with .. cells					
									1	2	3	4	5	6
M10	66	64	50	36	5	15,5	26	M20	43	52	62	71	81	90
N20	82	78	57	53	4,5	17	29	M20	66	66	80	94	108	122
N33F	112	108	85	50	5	20	50	M25	92	92	92	110	128	146
N40	112	108	85	50	5	20	50	M25	92	92	110	128	146	164

- 1) Knock outs for M40/M32 + 4x M20 at top and bottom M32/M25 + 4x M20 at the right and left hand side.

### Motor terminal box mounting KE M10 - N20

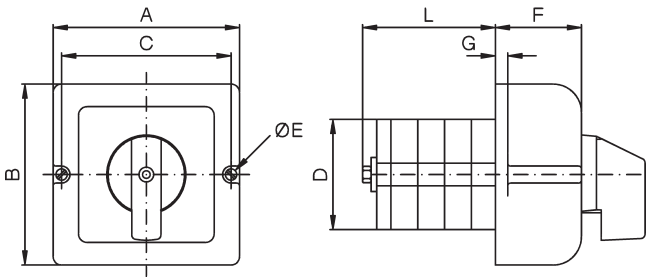

#### Mounting holes

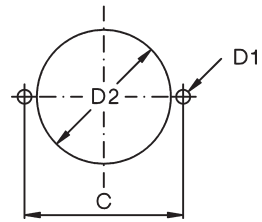

Type	A	B	C	D	D1	D2	E	F	G	Dimension L with .. cells					
										2	3	4	5	6	
M10	66	64	58	39	4	48	3,2	24	6	22	31,5	41	50,5	60	
N20	82	78	71	48	5	57	4,2	34	5	24,5	37	49,5	62	74,5	

### Plastic enclosed motor starter PM N20

Typ	P	Dimension L with .. cells					
		1	2	3	4	5	6
N20	M25	80	80	80	92,5	105	117,5

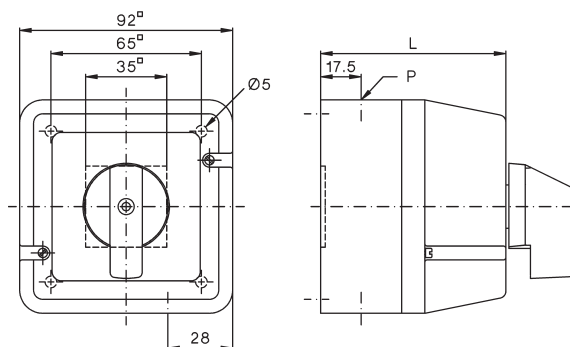

## Dimensions (mm)

Plastic enclosure horizontal PLF (Replacement for cast aluminium enclosure G, GF)  
N40, N61, N80

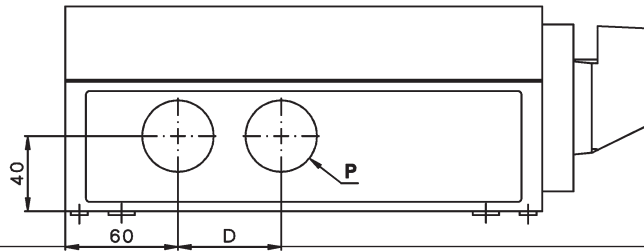
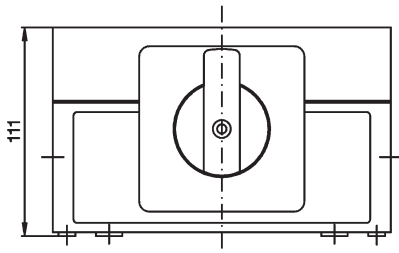

Type	N40 1 - 6 cells N61 1 - 3 cells N80 1 - 3 cells	N40 7 - 10 cells N61 4 - 6 cells N80 4 - 6 cells
A	182	254
B	167	239
C	120	190
D	-	65
P	2 x Ø40,5 (M40)	4 x Ø40,5 (M40)

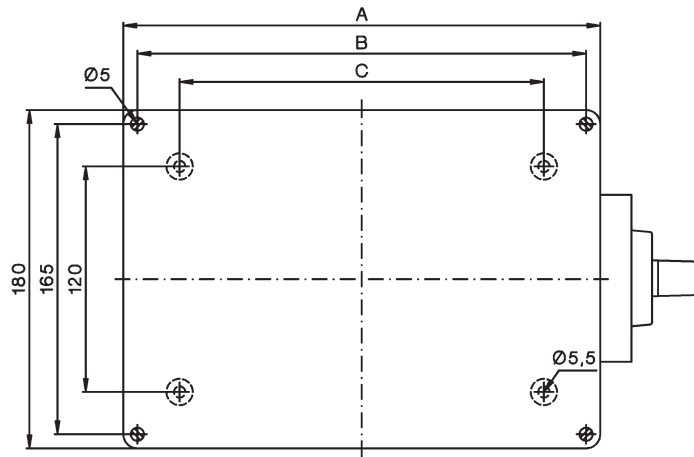

## Dimensions (mm)

### Load Switches

#### Panel mounting E

L100 - 400, L800, L1200

L600

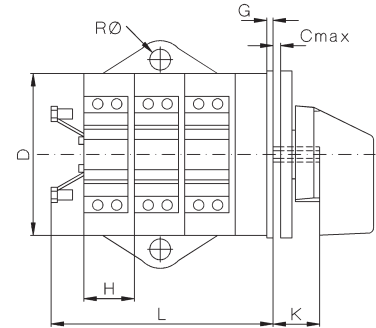
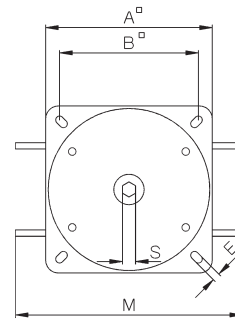
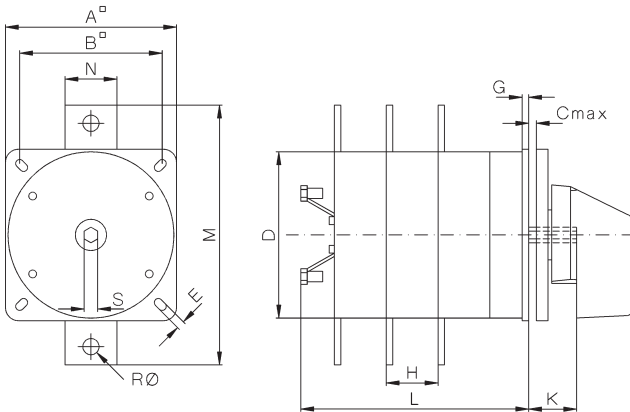

#### Base mounting V

L100 - 400, L800, L1200

L600

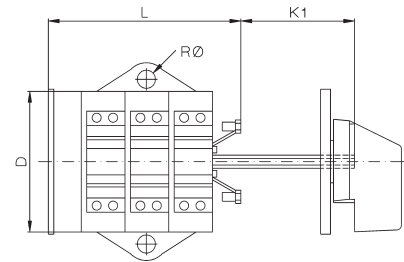
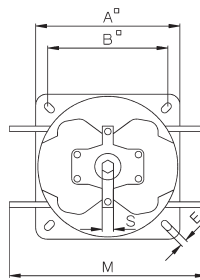
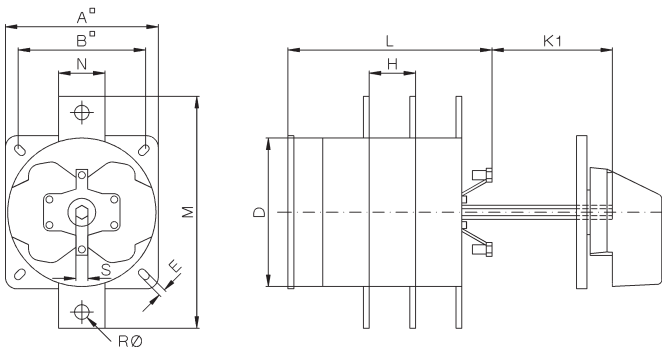

Typ	A	B	C	D	D1	D2	E	G	H	K	K1	M	N	R	S
L100	86	68	7	80	6	12	5,2	3,5	18	24,5	38,5	103	27	-	SW9
L400	132	110	9	128	7	16	6,2	5	40	37	104	200	40	12,5	SW12
L600	132	110	9	128	7	16	6,2	5	40	37	104	180	-	16,5	SW12
L800	132	110	9	128	7	16	6,2	5	40	37	104	240	40	16,5	SW12
L1200	132	110	9	128	7	16	6,2	5	40	37	104	240	40	16,5	SW12

#### Mounting holes:

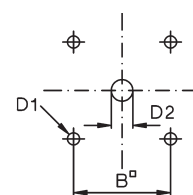

Type	Dimension L with .. cells											
	1	2	3	4	5	6	7	8	9	10	11	12
L100	52,5	70,5	88,5	106,5	124,5	142,5	160,5	178,5	196,5	214,5	232,5	250,5
L400	96	136	176	216	256	296	336	376	416	456	496	536
L600	96	136	176	216	256	296	336	376	416	456	496	536
L800	96	136	176	216	256	296	336	376	416	456	496	536
L1200	96	136	176	216	256	296	336	376	416	456	496	536

## Operating Knobs and Handles

### Instrument knob G.

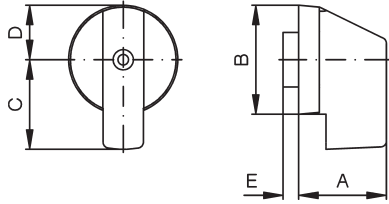

Type	A	B	C	D	E
M10, M10H, M10HD, M20	27	23	28	24	14
N20, N33F	36	36	32	18	3
N40, N61, N80, L100	36	47	42	24	3,5
N100, N200	48,10	75	63	37,5	-

4

### Toggle knob K.

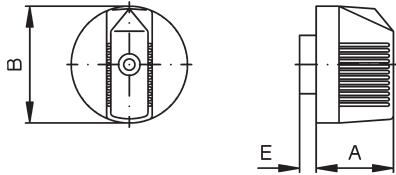

Type	A	B	E
M10, M10H, M10HD, M20	18,5	28	4
N20, N33F	24	36	3

### Escutcheon plates

#### Escutcheon plate

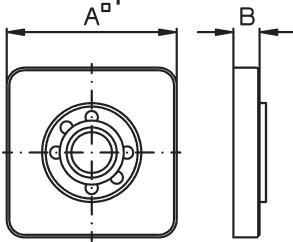

Type	A	B
M10, M10H, M10HD, M20	48	7,5
N20, N33F	64	7,5
N40, N61, N80, L100, L160	88	8
N100, N200, L400, L600, L800, L1200	132	9

#### Rectangular additional plate SRE

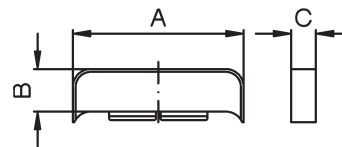

Type	A	B	C
M10, M10H, M10HD, M20	48	12	7,5
N20, N33F	64	14	7,5
N40, N61, N80, L100, L160	88	22	8
N100, N200, L400, L600, L800, L1200	132	31	9

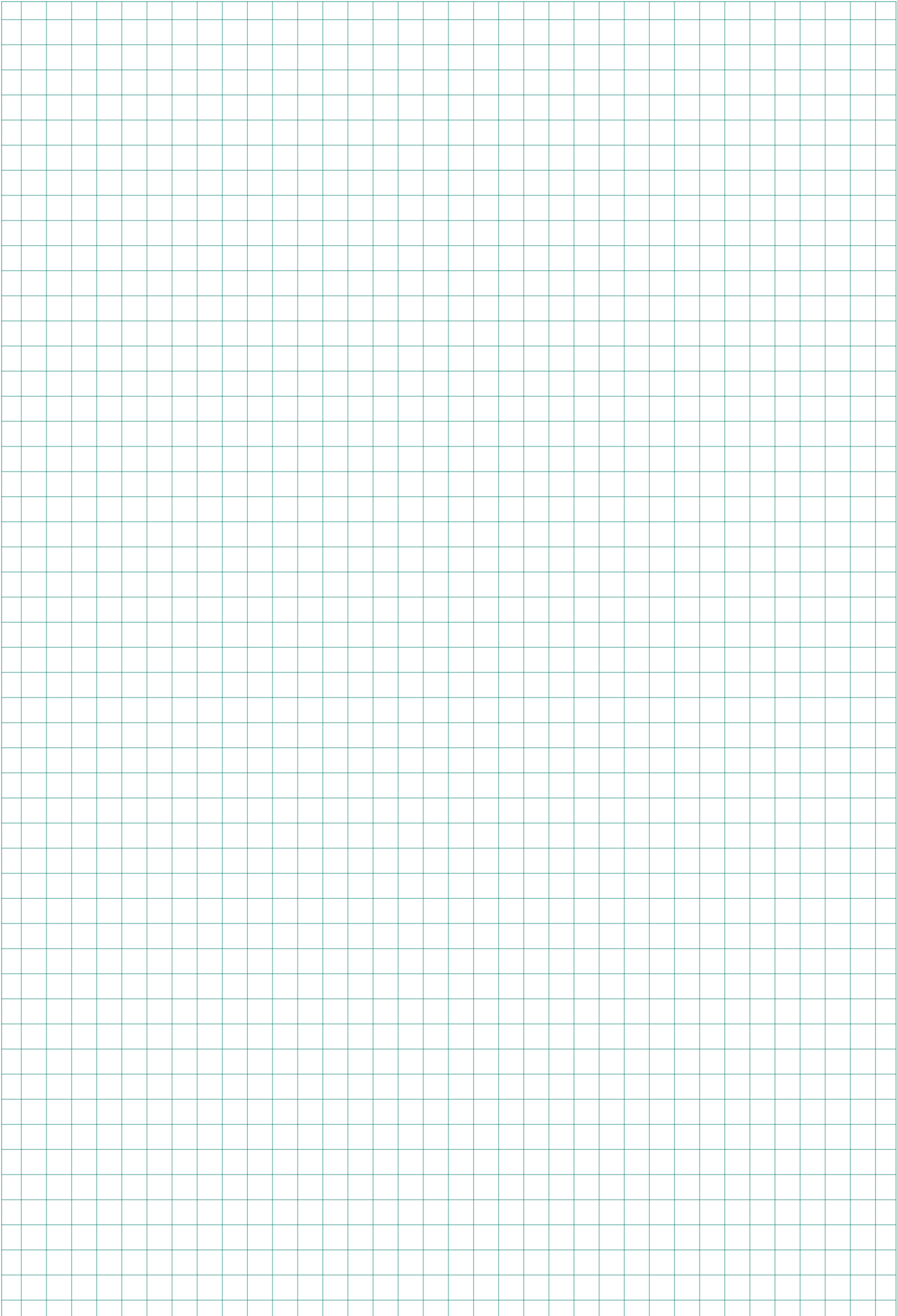

## Door couplings

Dimension T is a minimum value. In case of order the dimension T is necessary.

### Door coupling TK, TKFR N40 - L800

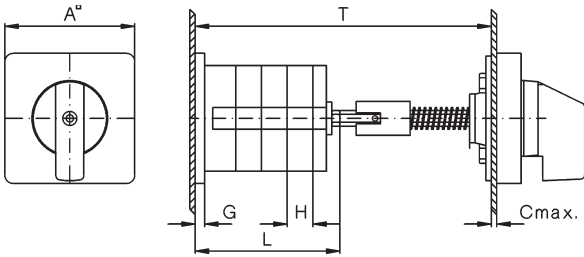

### Door coupling, lockable TK2, TK2FR N40 - L800

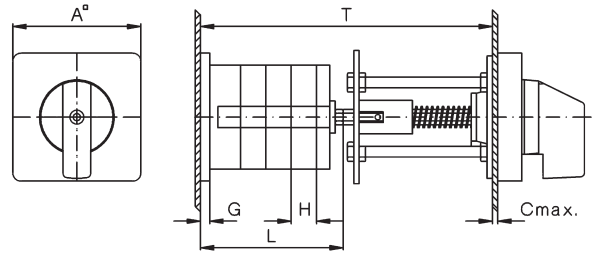

### Door coupling TKE, TK2E M10H, M10HD, M20, N20, N33F

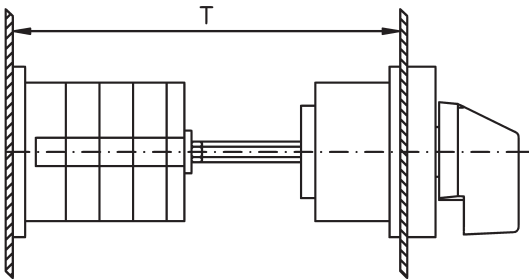

Mounting holes:  
TK, TKFR, TK2, TK2FR  
TKE, TK2E

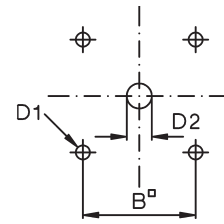

### Door coupling, lockable TK2Z M10H, M10HD, M20, N20, N33F

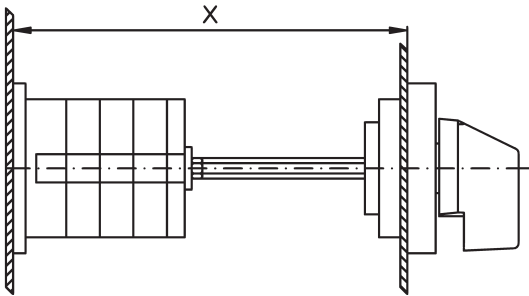

Mounting holes:  
TKZ

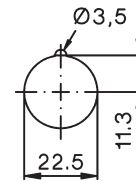

Further dimensions see pages 262 and 263.

Dimension T is a minimum value dependent on switch Type and number of cells. For ordering dimension T is necessary

Type	A	B	C	D1	D2	Minimum dimension T with .. cells							
						1	2	3	4	5	6	7	8
<b>M10H</b>	48	36	5	5	8	108	117,5	127	136,5	146	155,5	165	174,5
<b>M20</b>	48	36	5	5	8	100	112,5	125	137,5	150	162,5	175	187,5
<b>N20</b>	64	48	5	5	10	100	112,5	125	137,5	150	162,5	175	187,5
<b>N33F</b>	64	48	5	5	10	103	118,5	134	149,5	165	180,5	196	211,5
<b>N40</b>	88	48	7	6	12	134	152	170	188	206	224	242	260
<b>N61</b>	88	48	7	6	12	145,5	175	245,5	234	263,5	293	322,5	352
<b>N80</b>	88	48	7	6	12	145,5	175	245,5	234	263,5	293	322,5	352
<b>N100</b>	132	110	9	7	15	202	232	262	292	322	352	382	412
<b>N200</b>	132	110	9	7	15	212	252	292	332	372	412	452	492
<b>L100</b>	88	48	7	6	12	-	152	-	188	-	224	-	260
<b>L400</b>	132	110	9	7	15	212	252	292	332	372	412	452	492
<b>L600</b>	132	110	9	7	15	-	-	292	-	-	412	-	-
<b>L800</b>	132	110	9	7	15	-	252	-	332	-	412	452	492
<b>L1200</b>	132	110	9	7	15	-	-	292	-	-	412	-	-

## Key operated switches SA

### Panel mounting E M10 - N61

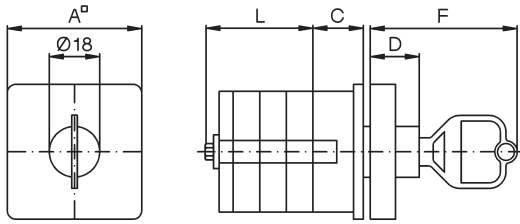

Type	A	B	C	D	D1	D2	F
M10H, M10HD, M20	48	36	18	17,5	5	18,5	52,5
N20, N33F	64	48	10	17,5	5	18,5	52,5
N40, N61	88	68	23,5	15	6	18,5	50

### Mounting holes

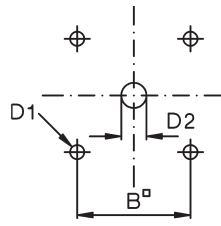

Dimension L see page 262

### Base mounting V M10 - N61

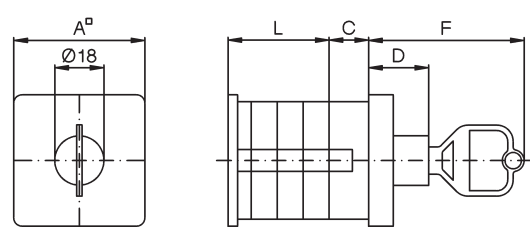

Type	A	C	D	F
M10H, M10HD, M20	48	18	22	57
N20, N33F	64	8	22	57
N40, N61	88	15	15	50

Dimension L see page 263

### Central fixing Z M10H Z ... + SA M20 Z ... + SA

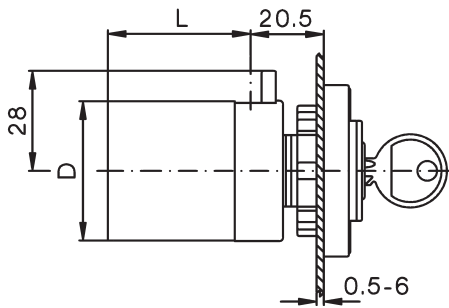

### Central fixing without escutcheon plate ZO M10H ZO ... + SA M20 ZO ... + SA

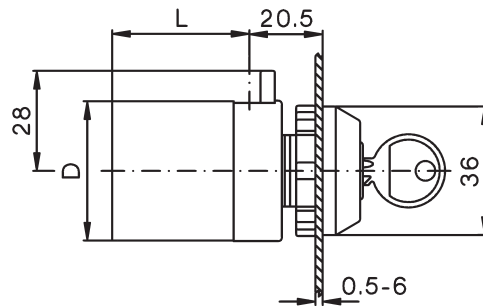

### Mounting holes:

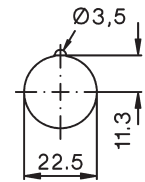

Further dimensions see page 262

### DIN rail mounting SMA M10H, M10HD, M20

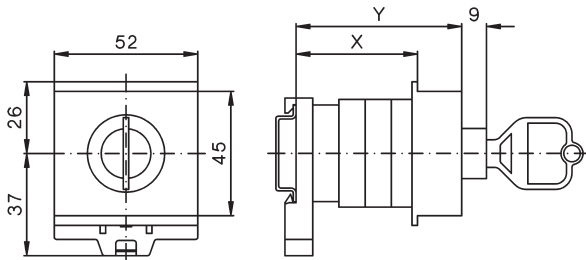

Type	Dimension X with .. cells				Dimension Y with .. cells			
	1	2	3	4	1	2	3	4
M10H	44	75	75	91	60	90	90	107
M20	59	75	75	91	75	90	90	107

### Flush mounting UP M10

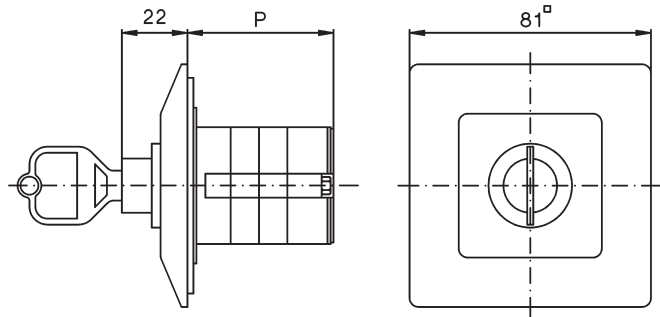

### Plastic enclosed switches P, PF M10, N20, N33F, N40, N61

Type	Dimension P with .. cells			
	1	2	3	4
M10	62	71	81	90
N20	66	80	94	108
N33F	92	110	110	128
N40	92	110	-	-
N61	110	-	-	-

Further dimensions see page 264

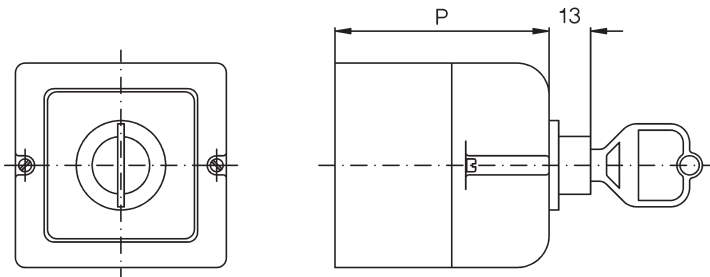

## Key operated switches

**Key operated switch SAK**  
Panel mounting E M10H, M10HD, M20

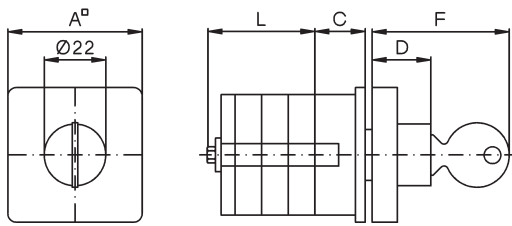

Type	A	B	C	D	D1	D2	F
M10H, M10HD, M20	48	36	25	21	5	22,5	49

**Mounting holes**

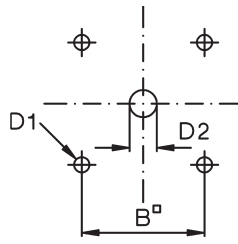

**Key operated switch SAK**  
Base mounting V M10H, M10HD, M20

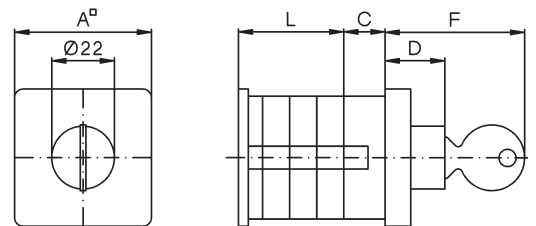

Type	A	C	D	F
M10H, M10HD, M20	48	25	21	49

## Fire Brigade Switch

**Neon safety switch N20 E .. +FEU, N33F E .. +FEU**

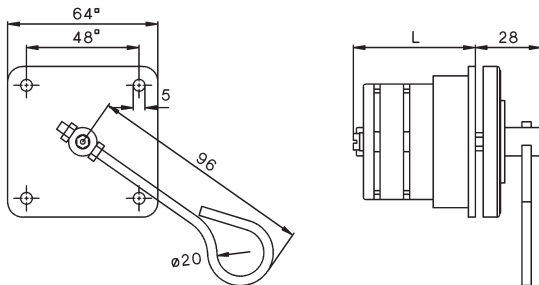

Further dimensions see pages 262

## Padlock devices

**Padlock device SV1** (max. 2 padlocks with stirrup  $\varnothing 6\text{mm}$ )  
**M10H, M10HD, M20**  
**Mounting holes design E, V**

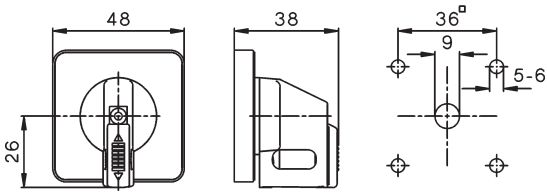

**Padlock device SV164**  
**M10H - N33F**  
**Mounting holes design E, V**

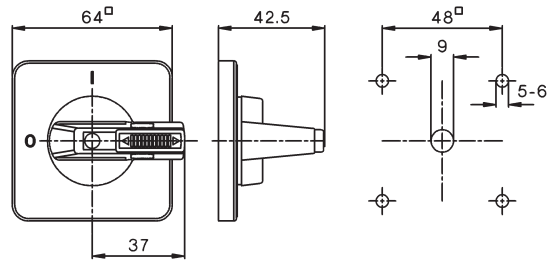

**Padlock device SV3** (max. 3 padlocks with stirrup  $\varnothing 8,5\text{mm}$ )  
**Panel mounting E**  
**N20 - N200, L100 - L1200**

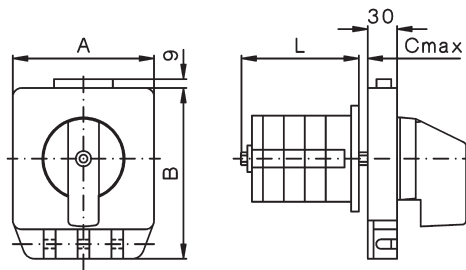

**Base mounting V**  
**N20 - N200, L100 - L1200**

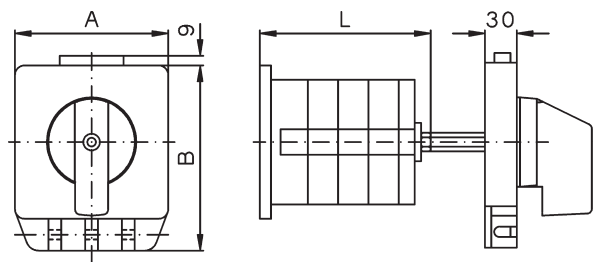

Further dimensions see page 263

Type	A	B	C
N20, N33F	102	128	5
N40, N61, N80, L100	102	128	7
N100, N200, L400, L600, L800, L1200	132	159	9

**Padlock device SV4** (max. 3 padlocks with stirrup  $\varnothing 6\text{mm}$ )  
**M10H - N33F**  
**Mounting holes design E, V**

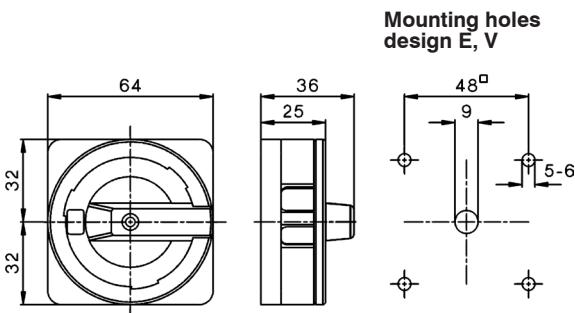

**Padlock device SV4** (max. 3 padlocks with stirrup  $\varnothing 6\text{mm}$ )  
**N40 - N80, L100**  
**Padlock device SV488**  
**N20, N33F**  
**Mounting holes design E, V**

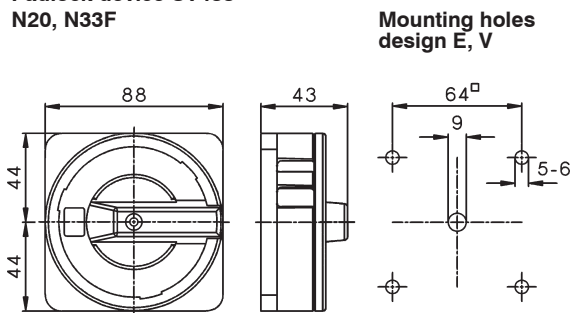

**Front plate/switch shaft sealing FPWD**  
**N20, N33F**

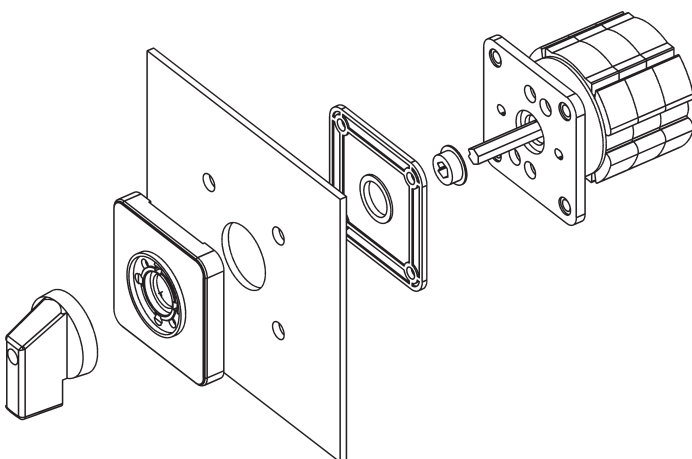

**Mounting holes**

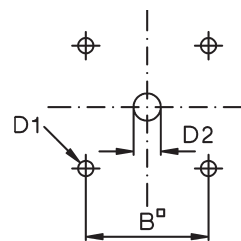

Typ	B	D1	D2
N20, N33F	48	5	17

## Interlocks, Moisture caps

### Lock switch SZ, SZ2 Panel mounting E

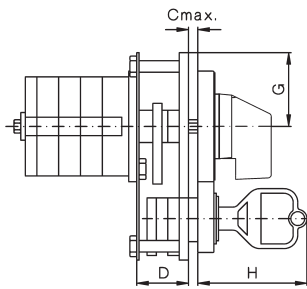
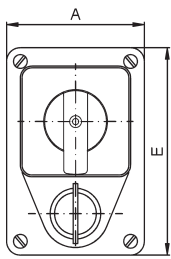

### Base mounting V

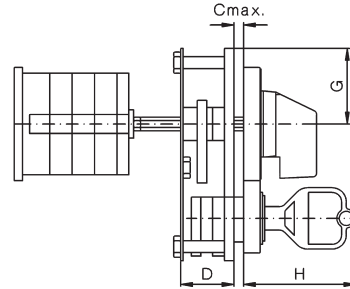
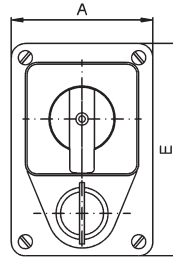

### Mounting holes

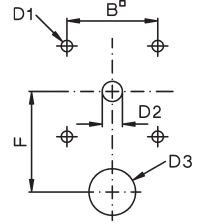

Type	A	B	C	D	D1	D2	D3	E	F	G	H
M10H, M10HD, M20	60	36	3	22,5	5	8	18,5	90	40	32	47,5
N20, N33F	60	36	3	22,5	5	12	18,5	90	45	32	47,5
N40, N61, N80, L100, L160	90	68	4	24	6	12	18,5	142	61	61,5	48
N100, N200, L400, L600, L800, L1200	140	110	4	27	7	15	18,5	180	83	90,5	49

### Push-button switch lock DV Switch interlock with electrical contact ET Panel mounting E

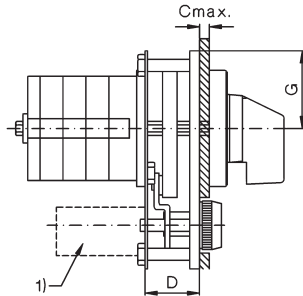
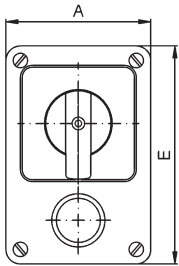

### Base mounting V

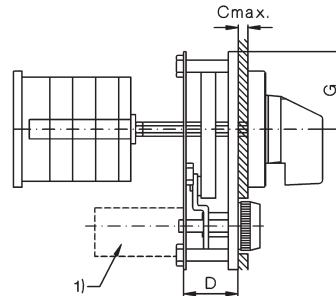
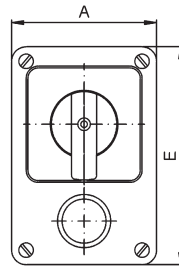

### Mounting holes

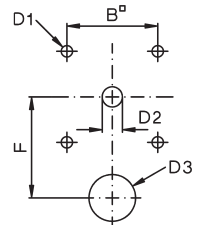



Type	A	B	C	D	D1	D2	D3	E	F	G
M10H, M10HD, M20	60	36	3	22,5	5	8	26	90	45	32
N20, N33F	60	36	3	22,5	5	10	26	90	45	32
N40, N601, N80, L100	90	68	4	25	6	12	29	142	61	61,5
N100, N200, L400, L600, L800, L1200	140	110	4	41	7	15	29	180	83	90,5

1) only at +ET



# Index

Page

	Main Switches for Panel Mounting	278
	Changover Switches for Panel Mounting	279
	Main Switches for Single Hole Mounting	279
	Main Switches for Base Mounting with Door Clutch	280
	Main Switches-Emergency-Stop for Panel Mounting	284
	Changover Switches-Emergency-Stop for Panel Mounting	285
	Main Switches-Emergency-Stop for Single Hole Mounting	285
	Main Switches-Emergency-Stop for Base Mounting	286
	Main Switches-Emergency-Stop for Distribution Boards	288
	Changover Switches-Emergency-Stop for Distribution Boards	288
	Maintenance and Safety Switches, in Plastic Enclosure	289
	Changover Safety Switches, in Plastic Enclosure	289
	Switch Disconnectors for Panel Mounting	290
	Switch Disconnectors for Single Hole Mounting	291
	Switch Disconnectors for Base Mounting	291
	Switch Disconnectors for Distribution Boards	293
	Switch Disconnectors in Plastic Enclosure	294
	Add-on modules	295
	Technical Data	297
	Dimensions	298

Contactors, Motor-Starters

Circuit Breakers

Manual Motor-Starters

Switches

AC-Main Switches

DC-Switch Disconnectors

Push Buttons

Representatives, Suppliers

Ratings									Panel mounting 4 hole mount. IP66	Single hole mount. Ø22,5mm IP66	
Protection degree from front in mounted position											
Type	Therm. I <sub>th open</sub> A	AC21 A	Motor at U <sub>e</sub> V	AC3 3~400V kW	AC23 3~400V A kW	AC21 3~40 0V kW	Plate Switch mm				
	LTS20	20	20	690	5,5	16	7,5	13,8	48□	LTS20 E <sup>1)</sup> ..	LTS20 Z <sup>1)</sup> ..
LTS25	25	25	690	7,5	20	10	17,3	48□	LTS25 E <sup>1)</sup> ..	LTS25 Z <sup>1)</sup> ..	
LTS32	32	32	690	11	25	12,5	22,1	48□	LTS32 E <sup>1)</sup> ..	LTS32 Z <sup>1)</sup> ..	
LTS40	40	40	690	15	32	16	27,6	48□	LTS40 E <sup>1)</sup> ..	LTS40 Z <sup>1)</sup> ..	
LTS63	63	63	690	18,5	45	22	43,6	48□	LTS63 E <sup>1)</sup> ..	-	
LTS80	80	80	690	18,5	45	22	55,3	48□	LTS80 E <sup>1)</sup> ..	-	
LTS85	85	85	690	22	60	30	58,8	64□	LTS85 E <sup>1)</sup> ..	-	
LTS100	100	100	690	30	72	37	69,2	64□	LTS100 E <sup>1)</sup> ..	-	
LTS125	125	125	690	37	85	45	86,5	64□	LTS125 E <sup>1)</sup> ..	-	
LT160	160	160	690	45	110	55	110	88□	LT160 E <sup>1)</sup> ..	-	

## Switch disconnectors 20 - 160A

Switch disconnectors are to be used as an ON-OFF-switch where a high breaking capacity with high contact pressure and in fact better short circuit behavior is necessary. These applications are:

**Main switches** according to IEC/EN 60204 respectively VDE0113 with interlocking device, terminal protection and restrictive contacts.

**Switch disconnectors** according to IEC/EN 60947-3 and VDE 0660 part 107 with break distance for 690V.

**Motor switches** 3-pole or 4-pole; according to IEC/EN 60947-3 respectively VDE 0660 part 107, motor switches series LT are dimensioned for switching high rated current AC3 and AC23A.

## Switch program

On-Off Switch 3-pole	.. ...	A3
On-Off Switch 4-pole	.. ...	A4
On-Off Switch 6-pole	.. ...	A6
On-Off Switch 8-pole	.. ...	A8
Changeover Switches 3-pole	.. ...	U3
Changeover Switches 4-pole	.. ...	U4
On-Off Switch 3-pole	.. ...	T300 (for LT160)
On-Off Switch 4-pole	.. ...	T400 (for LT160)

## Mounting positions:

No limitations, all kind of positions allowed.

## Main switches and Main switches with Emergency-Stop function

According to standards IEC/EN60204 or VDE0113, all electrical equipment of industrial machines must be equipped with a main switch. This must permit disconnection of all the electrical equipment during cleaning, maintenance and repair work, and other extended periods when it is stationary. In case of two or more main switches, an interlock system must be used. It is recommended to use a multiple-pole main switch (cam switch).

**Main switches** have to correspond to:

- Switch disconnector according to IEC/EN 60947-3 and VDE 0660 part 107 for utilization category AC23-B or DC-23B.
- Disconnectors are selected according to thermal rated current. They must possess a contact that ensures load switching via the contactors (see switching program A3-10). This contact must have a sufficient AC15 switching capacity.
- The interruption capacity of the switch must equal or exceed the locked rotor current of the largest motor plus the total current of all other electrical equipment in the circuit.

Requirements:

Interruption of the electrical equipment, with only on and off positions clearly marked with O and I.

It must be lockable in the off setting.

The line terminals of the main switch must be protected according to utilization category IP2X.

Colour of handle black or grey.

**Main switches with Emergency-Off function** are additional supplied with red handles and contrasting yellow escutcheon plates.

1) Main Switches (H1/H4 Main Switches-Emergency-Stop (HN1/HN4))  
Switch Disconnectors (without H(N)1/4)

<p>Base mounting with door coupling Handle Single hole mount. Ø22,5mm IP66</p>	<p>Base mounting with door coupling Panel mounting 4 hole mount. IP66</p>	<p>Modular switch IP40</p>	<p>Plastic enclosed IP66, see page 296</p>
--	---	--------------------------------	--



VZVH4	VZVHN4	VZVHN1	VH4	VHN4	VHN1	SMA	SMAHN1(N) <sup>5)</sup>	SMAH1(N) <sup>3)</sup>	PF(L <sup>2)</sup> )H4	PF(L <sup>2)</sup> )HN4	PF(L <sup>2)</sup> )
LTS20 VZV <sup>1)</sup> ..			LTS20 V <sup>1)</sup> ..			LTS20 SMA <sup>1)</sup> ..			LTS20 PF(L <sup>2)</sup> ) <sup>1)</sup> ..		
LTSM20 VZV <sup>1)</sup> ..			LTSM20 V <sup>1)</sup> ..			LTSM20 SMA <sup>1)</sup> ..			LTSM20 PF(L <sup>2)</sup> ) <sup>1)</sup> ..		
LTS25 VZV <sup>1)</sup> ..			LTS25 V <sup>1)</sup> ..			LTS25 SMA <sup>1)</sup> ..			LTS25 PF(L <sup>2)</sup> ) <sup>1)</sup> ..		
LTSM25 VZV <sup>1)</sup> ..			LTSM25 V <sup>1)</sup> ..			LTSM25 SMA <sup>1)</sup> ..			LTSM25 PF(L <sup>2)</sup> ) <sup>1)</sup> ..		
LTS32 VZV <sup>1)</sup> ..			LTS32 V <sup>1)</sup> ..			LTS32 SMA <sup>1)</sup> ..			LTS32 PF(L <sup>2)</sup> ) <sup>1)</sup> ..		
LTSM32 VZV <sup>1)</sup> ..			LTSM32 V <sup>1)</sup> ..			LTSM32 SMA <sup>1)</sup> ..			LTSM32 PF(L <sup>2)</sup> ) <sup>1)</sup> ..		
LTS40 VZV <sup>1)</sup> ..			LTS40 V <sup>1)</sup> ..			LTS40 SMA <sup>1)</sup> ..			LTS40 PF(L <sup>2)</sup> ) <sup>1)</sup> ..		
LTSM40 VZV <sup>1)</sup> ..			LTSM40 V <sup>1)</sup> ..			LTSM40 SMA <sup>1)</sup> ..			LTSM40 PF(L <sup>2)</sup> ) <sup>1)</sup> ..		
LTS63 VZV <sup>1)</sup> ..			LTS63 V <sup>1)</sup> ..			LTS63 SMA <sup>1)</sup> ..			LTS63 PFL <sup>1)</sup> ..		
LTS80 VZV <sup>1)</sup> ..			LTS80 V <sup>1)</sup> ..			LTS80 SMA <sup>1)</sup> ..			LTS80 PFL <sup>1)</sup> ..		
LTS85 VZV <sup>1)</sup> ..			LTS85 V <sup>1)</sup> ..			LTS85 SMA <sup>1)</sup> ..			LTS85 PFL <sup>1)</sup> ..		
LTS100 VZV <sup>1)</sup> ..			LTS100 V <sup>1)</sup> ..			LTS100 SMA <sup>1)</sup> ..			LTS100 PFL <sup>1)</sup> ..		
LTS125 VZV <sup>1)</sup> ..			LTS125 V <sup>1)</sup> ..			LTS125 SMA <sup>1)</sup> ..			LTS125 PFL <sup>1)</sup> ..		
-			LT160 V <sup>1)</sup> ..			-			LT160 PF <sup>1)</sup> .. <sup>3)</sup>		

### Approvals

Area	USA, Canada / UL	Europe	Eurasia / EAC	CB/CCA-Certificates
Type				

**Switch disconnecter** (UL-Listed as MANUAL MOTOR CONTROLLER and suitable as MOTOR DISCONNECT)

Model	USA, Canada / UL	Europe	Eurasia / EAC	CB/CCA-Certificates
LTS(M)20	o	/	o	o
LTS(M)25	o	/	o	o
LTS(M)32	o	/	o	o
LTS(M)40	o	/	o	o
LTS63	o	/	o	o
LTS80	o	/	o	o
LTS85	o	/	-	-
LTS100	o	/	-	-
LTS125	o	/	-	-
LT160	o	/	-	o

o in standard version approved  
/ No testing required CE  
x in test  
- Not provided for test til now













### Terminal screws

Devices	Kind of connection		Tightening torque		Protection class of terminals <sup>4)</sup>
	screw with clamp box	Screwdriver	Nm	lb. inch	
<b>Switch Disconnectors</b>					
LTS(M)20, LTS(M)25	M3,5		1,0 - 1,7	15 - 20	IP20
LTS(M)32, LTS(M)40	M5		2,8 - 4	25 - 35	IP20
LTS63, LTS80	M6		1,7 - 4,5	15 - 40	IP20
LTS85, LTS100, LTS125	M10		14	124	IP20
LT160					

1) Main Switches (H1/H4 Main Switches-Emergency-Stop (HN1/HN4)) and Switch Disconnectors (without H(N)1/4)  
2) PFL... larger enclosure  
3) IP. Type..  
4) Protection degree of the terminals with connected insulated conductor. Additional protection with terminal cover (KLAD).  
5) H(N)1N ... low height handle (10mm)

Contactors, Motor-Starter  
 Circuit Breakers  
 Manual Motor-Starters  
 Switches  
 AC-Main Switches  
 DC-Switch Disconnecter  
 Push Buttons  
 Representatives, Suppliers

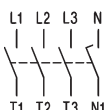
## Main Switches for Panel Mounting, lockable IP66, Type 3R

		max. padlocks	AC21 690V	AC23 3x400V	Plate	Type	Pack pcs.	Weighth kg/pcs.
<b>3-pole, padlock device SV1</b>  			20A	<b>7,5kW</b>	48 □ <sup>1)</sup>	LTS20 EH1 A3	1	0,15
			25A	<b>10kW</b>	48 □ <sup>1)</sup>	LTS25 EH1 A3	1	0,15
			32A	<b>12,5kW</b>	48 □ <sup>1)</sup>	LTS32 EH1 A3	1	0,15
			40A	<b>16kW</b>	48 □ <sup>1)</sup>	LTS40 EH1 A3	1	0,15
			63A	<b>22kW</b>	48 □ <sup>1)</sup>	LTS63 EH1 A3	1	0,17
			80A	<b>22kW</b>	48 □ <sup>1)</sup>	LTS80 EH1 A3	1	0,17
<b>4-pole, padlock device SV1</b>  			20A	<b>7,5kW</b>	48 □ <sup>1)</sup>	LTS20 EH1 A4	1	0,19
			25A	<b>10kW</b>	48 □ <sup>1)</sup>	LTS25 EH1 A4	1	0,19
			32A	<b>12,5kW</b>	48 □ <sup>1)</sup>	LTS32 EH1 A4	1	0,19
			40A	<b>16kW</b>	48 □ <sup>1)</sup>	LTS40 EH1 A4	1	0,19
			63A	<b>22kW</b>	48 □ <sup>1)</sup>	LTS63 EH1 A4	1	0,21
			80A	<b>22kW</b>	48 □ <sup>1)</sup>	LTS80 EH1 A4	1	0,21
<b>3-pole, padlock device SV4(34)</b>  			20A	<b>7,5kW</b>	64 □ <sup>2)</sup>	LTS20 EH4 A3	1	0,17
			25A	<b>10kW</b>	64 □ <sup>2)</sup>	LTS25 EH4 A3	1	0,17
			32A	<b>12,5kW</b>	64 □ <sup>2)</sup>	LTS32 EH4 A3	1	0,17
			40A	<b>16kW</b>	64 □ <sup>2)</sup>	LTS40 EH4 A3	1	0,17
			63A	<b>22kW</b>	64 □ <sup>2)</sup>	LTS63 EH4 A3	1	0,19
			80A	<b>22kW</b>	64 □ <sup>2)</sup>	LTS80 EH4 A3	1	0,19
			80A	<b>30kW</b>	64 □ <sup>2)</sup>	LTS85 EH4 A3	1	0,39
			100A	<b>37kW</b>	64 □ <sup>2)</sup>	LTS100 EH4 A3	1	0,39
			125A	<b>45kW</b>	64 □ <sup>2)</sup>	LTS125 EH4 A3	1	0,39
			160A	<b>55kW</b>	88 □	LT160 EH34 T300	1	1,16
<b>4-pole, padlock device SV4(34)</b>  			20A	<b>7,5kW</b>	64 □ <sup>2)</sup>	LTS20 EH4 A4	1	0,20
			25A	<b>10kW</b>	64 □ <sup>2)</sup>	LTS25 EH4 A4	1	0,20
			32A	<b>12,5kW</b>	64 □ <sup>2)</sup>	LTS32 EH4 A4	1	0,20
			40A	<b>16kW</b>	64 □ <sup>2)</sup>	LTS40 EH4 A4	1	0,20
			63A	<b>22kW</b>	64 □ <sup>2)</sup>	LTS63 EH4 A4	1	0,23
			80A	<b>22kW</b>	64 □ <sup>2)</sup>	LTS80 EH4 A4	1	0,23
			85A	<b>30kW</b>	64 □ <sup>2)</sup>	LTS85 EH4 A4	1	0,44
			100A	<b>37kW</b>	64 □ <sup>2)</sup>	LTS100 EH4 A4	1	0,44
			125A	<b>45kW</b>	64 □ <sup>2)</sup>	LTS125 EH4 A4	1	0,44
	160A	<b>55kW</b>	88 □	LT160 EH34 T400	1	1,55		

**Add-on modules** see page 297





**Extended Switch Shaft for switches for panel mounting** type suffix **+VW"x"**

x = panel thickness



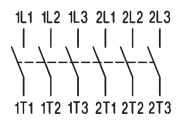

1) Types with padlock device 64 □ type suffix **64**, ordering example: LTS32 EH1**64** A3, on request

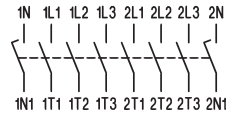
2) Types with padlock device 88 □ type suffix **88**, ordering example: LTS32 EH4**88** A3, on request



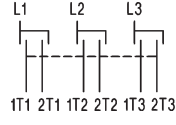

## Main Switches for Panel Mounting, lockable IP66, Type 3R

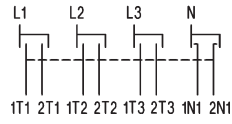
		max. padlocks	AC21 690V	AC23 3x400V	Plate	Type	Pack pcs.	Weight kg/pcs.
<b>6-pole, padlock device SV4</b> 								
			20A	<b>7,5kW</b>	64 □	LTS20 EH4 A6	1	0,30
			25A	<b>10kW</b>	64 □	LTS25 EH4 A6	1	0,30
			32A	<b>12,5kW</b>	64 □	LTS32 EH4 A6	1	0,30
			40A	<b>16kW</b>	64 □	LTS40 EH4 A6	1	0,30
			63A	<b>22kW</b>	64 □	LTS63 EH4 A6	1	0,34
			80A	<b>22kW</b>	64 □	LTS80 EH4 A6	1	0,34
<b>8-pole, padlock device SV4</b> 								
			20A	<b>7,5kW</b>	64 □	LTS20 EH4 A8	1	0,38
			25A	<b>10kW</b>	64 □	LTS25 EH4 A8	1	0,38
			32A	<b>12,5kW</b>	64 □	LTS32 EH4 A8	1	0,38
			40A	<b>16kW</b>	64 □	LTS40 EH4 A8	1	0,38
			63A	<b>22kW</b>	64 □	LTS63 EH4 A8	1	0,42
			80A	<b>22kW</b>	64 □	LTS80 EH4 A8	1	0,42

## Changeover Switches with padlockdevice for Panel Mounting, lockable IP66



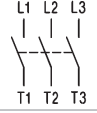

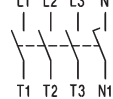
<b>3-pole, padlock device SV4</b> 								
			20A	<b>7,5kW</b>	64 □	LTS20 EH4 U3	1	0,30
			25A	<b>10kW</b>	64 □	LTS25 EH4 U3	1	0,30
			32A	<b>12,5kW</b>	64 □	LTS32 EH4 U3	1	0,30
			40A	<b>16kW</b>	64 □	LTS40 EH4 U3	1	0,30
			63A	<b>22kW</b>	64 □	LTS63 EH4 U3	1	0,34
<b>4-pole, padlock device SV4</b> 								
			20A	<b>7,5kW</b>	64 □	LTS20 EH4 U4	1	0,38
			25A	<b>10kW</b>	64 □	LTS25 EH4 U4	1	0,38
			32A	<b>12,5kW</b>	64 □	LTS32 EH4 U4	1	0,38
			40A	<b>16kW</b>	64 □	LTS40 EH4 U4	1	0,38
			63A	<b>22kW</b>	64 □	LTS63 EH4 U4	1	0,42

## Main Switches for Single Hole Mounting IP66, Type 4X

		max. padlocks	AC21 690V	AC23 3x400V	Plate	Type	Pack pcs.	Weight kg/pcs.
<b>3-pole, padlock device SV1</b> 								
			20A	<b>7,5kW</b>	48 □	LTS20 ZH1 A3	1	0,16
			25A	<b>10kW</b>	48 □	LTS25 ZH1 A3	1	0,16
			32A	<b>12,5kW</b>	48 □	LTS32 ZH1 A3	1	0,16
			40A	<b>16kW</b>	48 □	LTS40 ZH1 A3	1	0,16
<b>4-pole, padlock device SV1</b> 								
			20A	<b>7,5kW</b>	48 □	LTS20 ZH1 A4	1	0,20
			25A	<b>10kW</b>	48 □	LTS25 ZH1 A4	1	0,20
			32A	<b>12,5kW</b>	48 □	LTS32 ZH1 A4	1	0,20
			40A	<b>16kW</b>	48 □	LTS40 ZH1 A4	1	0,20

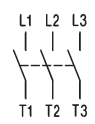
Add-on modules see page 297

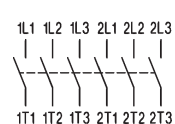
Main Switches, Base Mounting with Door Clutch for Single-Hole Mounting  
 Depth X is adjustable (delivered with  $X_{max}$  see below), IP66,  $c(U_L)_{US}$  Type 4X

		max. padlocks	AC21 690V	AC23 3x400V	Plate	Type	Pack pcs.	Weight kg/pcs.
<b>3-pole, padlock device SV4</b>  								
	20A		<b>7,5kW</b>	64 □	LTSM20 VZVH4 A3	1	0,19	
	25A		<b>10kW</b>	64 □	LTSM25 VZVH4 A3	1	0,19	
	32A		<b>12,5kW</b>	64 □	LTSM32 VZVH4 A3	1	0,19	
	40A		<b>16kW</b>	64 □	LTSM40 VZVH4 A3	1	0,19	
	63A		<b>22kW</b>	64 □	LTS63 VZVH4 A3	1	0,22	
	80A		<b>22kW</b>	64 □	LTS80 VZVH4 A3	1	0,22	
	85A		<b>30kW</b>	64 □	LTS85 VZVH4 A3	1	0,40	
	100A		<b>37kW</b>	64 □	LTS100 VZVH4 A3	1	0,40	
	125A		<b>45kW</b>	64 □	LTS125 VZVH4 A3	1	0,40	
<b>4-pole, padlock device SV4</b>  								
	20A		<b>7,5kW</b>	64 □	LTS20 VZVH4 A4	1	0,20	
	25A		<b>10kW</b>	64 □	LTS25 VZVH4 A4	1	0,20	
	32A		<b>12,5kW</b>	64 □	LTS32 VZVH4 A4	1	0,20	
	40A		<b>16kW</b>	64 □	LTS40 VZVH4 A4	1	0,20	
	63A		<b>22kW</b>	64 □	LTS63 VZVH4 A4	1	0,26	
	80A		<b>22kW</b>	64 □	LTS80 VZVH4 A4	1	0,26	
	85A		<b>30kW</b>	64 □	LTS85 VZVH4 A4	1	0,45	
	100A		<b>37kW</b>	64 □	LTS100 VZVH4 A4	1	0,45	
	125A		<b>45kW</b>	64 □	LTS125 VZVH4 A4	1	0,45	
<b>6-pole, padlock device SV4</b>  								
	20A		<b>7,5kW</b>	64 □	LTS20 VZVH4 A6	1	0,32	
	25A		<b>10kW</b>	64 □	LTS25 VZVH4 A6	1	0,32	
	32A		<b>12,5kW</b>	64 □	LTS32 VZVH4 A6	1	0,32	
	40A		<b>16kW</b>	64 □	LTS40 VZVH4 A6	1	0,32	
	63A		<b>22kW</b>	64 □	LTS63 VZVH4 A6	1	0,37	
80A		<b>22kW</b>	64 □	LTS80 VZVH4 A6	1	0,37		
<b>8-pole, padlock device SV4</b>  								
	20A		<b>7,5kW</b>	64 □	LTS20 VZVH4 A8	1	0,34	
	25A		<b>10kW</b>	64 □	LTS25 VZVH4 A8	1	0,34	
	32A		<b>12,5kW</b>	64 □	LTS32 VZVH4 A8	1	0,34	
	40A		<b>16kW</b>	64 □	LTS40 VZVH4 A8	1	0,34	
	63A		<b>22kW</b>	64 □	LTS63 VZVH4 A8	1	0,45	
80A		<b>22kW</b>	64 □	LTS80 VZVH4 A8	1	0,45		

**Depth**  
 Single Hole Mounting Ø22mm  
 LTS.. VZV..

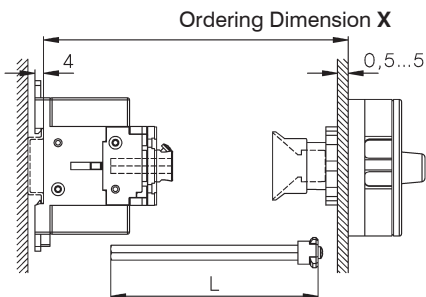

Type	X min	X max	L
LTS20-80 VZV.. 3, 4-pole	91	190	<b>X - 40±3</b>
LTS20-80 VZV.. 6, 8-pole	111	190	<b>X - 60±3</b>
LTS85-125 VZV.. 3, 4-pole	95	190	<b>X - 44±3</b>

**4-Hole Mounting**  
 LTS.. V(H).. (3, 4-pole)

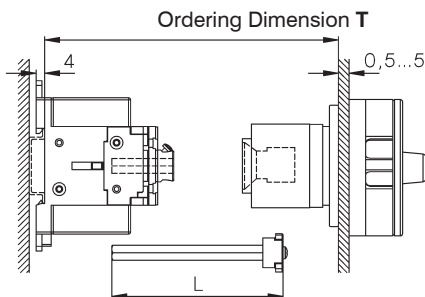



Type	T min	T max	L	Type	T min	T max
LTS20-80 VH..	111	190	<b>T - 60±3</b>	LT160 VH..	120	450
LTS85-125 VH..	115	190	<b>T - 64±3</b>			

greater X- and T-Dimensions (max. 380mm for LTS..) on request

## Main Switches, Base Mounting with Door Clutch, Padlock Device for 4-Hole Mounting

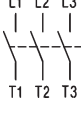

Depth T is adjustable (delivered with T<sub>max</sub> see page 282), IP66, cUL<sub>us</sub> Type 4X

	max. padlocks	AC21 690V	AC23 3x400V	Plate	Type	Pack pcs.	Weight kg/pcs.	
<b>3-pole, padlock device SV4(34)</b>  								
			20A	<b>7,5kW</b>	64 □ <sup>1)</sup>	LTSM20 VH4 A3	1	0,20
			25A	<b>10kW</b>	64 □ <sup>1)</sup>	LTSM25 VH4 A3	1	0,20
			32A	<b>12,5kW</b>	64 □ <sup>1)</sup>	LTSM32 VH4 A3	1	0,20
			40A	<b>16kW</b>	64 □ <sup>1)</sup>	LTSM40 VH4 A3	1	0,20
			63A	<b>22kW</b>	64 □ <sup>1)</sup>	LTS63 VH4 A3	1	0,24
			80A	<b>22kW</b>	64 □ <sup>1)</sup>	LTS80 VH4 A3	1	0,24
			85A	<b>30kW</b>	64 □ <sup>1)</sup>	LTS85 VH4 A3	1	0,40
			100A	<b>37kW</b>	64 □ <sup>1)</sup>	LTS100 VH4 A3	1	0,40
			125A	<b>45kW</b>	64 □ <sup>1)</sup>	LTS125 VH4 A3	1	0,40
		160A	<b>55kW</b>	88 □	LT160 VH34 T300	1	1,38	

<b>4-pole, padlock device SV4(34)</b>  			20A	<b>7,5kW</b>	64 □ <sup>1)</sup>	LTS20 VH4 A4	1	0,21
			25A	<b>10kW</b>	64 □ <sup>1)</sup>	LTS25 VH4 A4	1	0,21
			32A	<b>12,5kW</b>	64 □ <sup>1)</sup>	LTS32 VH4 A4	1	0,21
			40A	<b>16kW</b>	64 □ <sup>1)</sup>	LTS40 VH4 A4	1	0,21
			63A	<b>22kW</b>	64 □ <sup>1)</sup>	LTS63 VH4 A4	1	0,28
			80A	<b>22kW</b>	64 □ <sup>1)</sup>	LTS80 VH4 A4	1	0,28
			85A	<b>30kW</b>	64 □ <sup>1)</sup>	LTS85 VH4 A4	1	0,45
			100A	<b>37kW</b>	64 □ <sup>1)</sup>	LTS100 VH4 A4	1	0,45
			125A	<b>45kW</b>	64 □ <sup>1)</sup>	LTS125 VH4 A4	1	0,45
			160A	<b>55kW</b>	88 □	LT160 VH34 T400	1	1,77

## Emergency-Stop-Main Switches, Base Mounting with Door Clutch for Single-Hole Mounting

Depth X is not adjustable, declare depth X when ordering, IP66, cUL<sub>us</sub> Type 4X

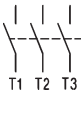
<b>3-pole, padlock device SV4</b>  			20A	<b>7,5kW</b>	64 □	LTSM20 VZH4 A3 X..	1	0,18
			25A	<b>10kW</b>	64 □	LTSM25 VZH4 A3 X..	1	0,18
			32A	<b>12,5kW</b>	64 □	LTSM32 VZH4 A3 X..	1	0,18
			40A	<b>16kW</b>	64 □	LTSM40 VZH4 A3 X..	1	0,18
			63A	<b>22kW</b>	64 □	LTS63 VZH4 A3 X..	1	0,25
			80A	<b>22kW</b>	64 □	LTS80 VZH4 A3 X..	1	0,25
<b>4-pole, padlock device SV4</b>  			20A	<b>7,5kW</b>	64 □	LTS20 VZH4 A4 X..	1	0,18
			25A	<b>10kW</b>	64 □	LTS25 VZH4 A4 X..	1	0,18
			32A	<b>12,5kW</b>	64 □	LTS32 VZH4 A4 X..	1	0,18
			40A	<b>16kW</b>	64 □	LTS40 VZH4 A4 X..	1	0,18
			63A	<b>22kW</b>	64 □	LTS63 VZH4 A4 X..	1	0,25
			80A	<b>22kW</b>	64 □	LTS80 VZH4 A4 X..	1	0,25

Declare depth X when ordering

Type	Prefered lengths for X
LT.. VZH..	80, 85, 104, 129 (tolerance -3, +1,5)

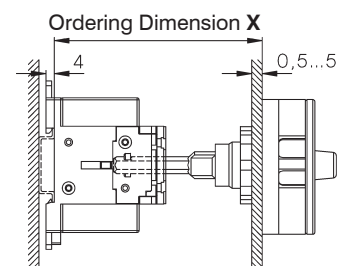



Add-on modules see page 297

1) Types with padlock device 88 'type suffix **88**, ordering example: LTSM32 VHN**488** A3, on request

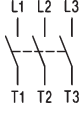
## Main Switches for Distribution Boards, lockable IP40, Open Type

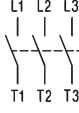
		max. padlocks	AC21 690V	AC23 3x400V	Plate	Type	Pack pcs.	Weight kg/pcs.
<b>3-pole, padlock device SV1</b>  								
			20A	<b>7,5kW</b>	35x45	LTSM20 SMAH1 (N <sup>2</sup> ) A3	1	0,15
			25A	<b>10kW</b>	35x45	LTSM25 SMAH1 (N <sup>2</sup> ) A3	1	0,15
			32A	<b>12,5kW</b>	35x45	LTSM32 SMAH1 (N <sup>2</sup> ) A3	1	0,15
			40A	<b>16kW</b>	35x45	LTSM40 SMAH1 (N <sup>2</sup> ) A3	1	0,15
			63A	<b>22kW</b>	52x45	LTS63 SMAH1 (N <sup>2</sup> ) A3	1	0,18
			80A	<b>22kW</b>	52x45	LTS80 SMAH1 (N <sup>2</sup> ) A3	1	0,18
			85A	<b>30kW</b>	78x45	LTS85 SMAH1 A3	1	0,37
		100A	<b>37kW</b>	78x45	LTS100 SMAH1 A3	1	0,37	
		125A	<b>45kW</b>	78x45	LTS125 SMAH1 A3	1	0,37	

<b>4-pole, padlock device SV1</b>  								
			20A	<b>7,5kW</b>	52x45	LTS20 SMAH1 (N <sup>2</sup> ) A4	1	0,16
			25A	<b>10kW</b>	52x45	LTS25 SMAH1 (N <sup>2</sup> ) A4	1	0,16
			32A	<b>12,5kW</b>	52x45	LTS32 SMAH1 (N <sup>2</sup> ) A4	1	0,16
			40A	<b>16kW</b>	52x45	LTS40 SMAH1 (N <sup>2</sup> ) A4	1	0,16
			63A	<b>22kW</b>	52x45	LTS63 SMAH1 (N <sup>2</sup> ) A4	1	0,21
			80A	<b>22kW</b>	52x45	LTS80 SMAH1 (N <sup>2</sup> ) A4	1	0,21
			85A	<b>30kW</b>	78x45	LTS85 SMAH1 A4	1	0,42
		100A	<b>37kW</b>	78x45	LTS100 SMAH1 A4	1	0,42	
		125A	<b>45kW</b>	78x45	LTS125 SMAH1 A4	1	0,42	

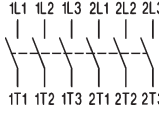
<b>6-pole, padlock device SV1 (64)</b>  								
			20A	<b>7,5kW</b>	52x45	LTS20 SMAH1 A6	1	0,29
			25A	<b>10kW</b>	52x45	LTS25 SMAH1 A6	1	0,29
			32A	<b>12,5kW</b>	52x45	LTS32 SMAH1 A6	1	0,29
			40A	<b>16kW</b>	52x45	LTS40 SMAH1 A6	1	0,29
			63A	<b>22kW</b>	97x45	LTS63 SMAH1 A6 <sup>1)</sup>	1	0,34
		80A	<b>22kW</b>	97x45	LTS80 SMAH1 A6 <sup>1)</sup>	1	0,34	

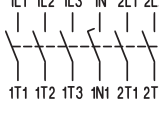
<b>8-pole, padlock device SV164</b>  								
			20A	<b>7,5kW</b>	97x45	LTS20 SMAH1 A8	1	0,31
			25A	<b>10kW</b>	97x45	LTS25 SMAH1 A8	1	0,31
			32A	<b>12,5kW</b>	97x45	LTS32 SMAH1 A8	1	0,31
			40A	<b>16kW</b>	97x45	LTS40 SMAH1 A8	1	0,31
			63A	<b>22kW</b>	126x45	LTS63 SMAH1 A8	1	0,42
		80A	<b>22kW</b>	126x45	LTS80 SMAH1 A8	1	0,42	

### Changeover Switch with Padlock Device for Distribution Boards, lockable

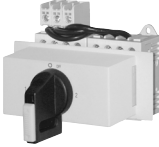
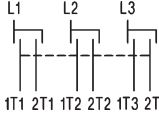

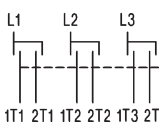







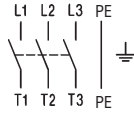

<b>3-pole, padlock device SV164</b>  								
			20A	<b>7,5kW</b>	97x45	LTS20 SMAH1 U3	1	0,29
			25A	<b>10kW</b>	97x45	LTS25 SMAH1 U3	1	0,29
			32A	<b>12,5kW</b>	97x45	LTS32 SMAH1 U3	1	0,29
			40A	<b>16kW</b>	97x45	LTS40 SMAH1 U3	1	0,29
		63A	<b>22kW</b>	97x45	LTS63 SMAH1 U3	1	0,34	

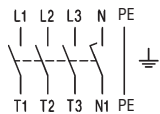
<b>4-pole, padlock device SV164</b>  								
			20A	<b>7,5kW</b>	97x45	LTS20 SMAH1 U4	1	0,31
			25A	<b>10kW</b>	97x45	LTS25 SMAH1 U4	1	0,31
			32A	<b>12,5kW</b>	97x45	LTS32 SMAH1 U4	1	0,31
			40A	<b>16kW</b>	97x45	LTS40 SMAH1 U4	1	0,31
		63A	<b>22kW</b>	126x45	LTS63 SMAH1 U4	1	0,42	

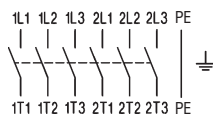
1) With padlock device SV164

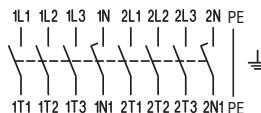

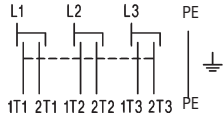

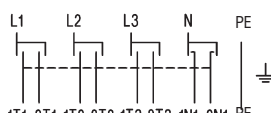





2) Emergency-Stop-Main Switches for Distribution Boards, lockable with low height handle (10mm), IP40  
i.e: **LTSM40 SMAH1N A3** or **LTS20 SMAH1N A4**

# Maintenance and Safety Switches, in Plastic Enclosure, lockable IP66, Type 4X

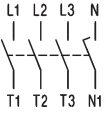
	max. padlocks	AC21 690V	AC23 3x400V	Plate	Type	Pack pcs.	Weight kg/pcs.
<b>3-pole, padlock device SV4(34)</b> 							
 		20A	<b>7,5kW</b>	64 □	LTSM20 PF(L <sup>1</sup> )H4 A3	1	0,32
		25A	<b>10kW</b>	64 □	LTSM25 PF(L <sup>1</sup> )H4 A3	1	0,32
		32A	<b>12,5kW</b>	64 □	LTSM32 PF(L <sup>1</sup> )H4 A3	1	0,32
		40A	<b>16kW</b>	64 □	LTSM40 PF(L <sup>1</sup> )H4 A3	1	0,32
		63A	<b>22kW</b>	64 □	LTS63 PFLH4 A3	1	0,60
		80A	<b>22kW</b>	64 □	LTS80 PFLH4 A3	1	0,60
		85A	<b>30kW</b>	64 □	LTS85 PFLH4 A3	1	0,78
		100A	<b>37kW</b>	64 □	LTS100 PFLH4 A3	1	0,78
		125A	<b>45kW</b>	64 □	LTS125 PFLH4 A3	1	0,78
		160A	<b>55kW</b>	88 □	LT160 PFH34 T300	1	2,09
Larger enclosure Type: ..PFL..	on request						
<b>4-pole, padlock device SV4(34)</b> 							
 		20A	<b>7,5kW</b>	64 □	LTS20 PF(L <sup>1</sup> )H4 A4	1	0,33
		25A	<b>10kW</b>	64 □	LTS25 PF(L <sup>1</sup> )H4 A4	1	0,33
		32A	<b>12,5kW</b>	64 □	LTS32 PF(L <sup>1</sup> )H4 A4	1	0,33
		40A	<b>16kW</b>	64 □	LTS40 PF(L <sup>1</sup> )H4 A4	1	0,33
		63A	<b>22kW</b>	64 □	LTS63 PFLH4 A4	1	0,64
		80A	<b>22kW</b>	64 □	LTS80 PFLH4 A4	1	0,64
		85A	<b>30kW</b>	64 □	LTS85 PFLH4 A4	1	0,83
		100A	<b>37kW</b>	64 □	LTS100 PFLH4 A4	1	0,83
		125A	<b>45kW</b>	64 □	LTS125 PFLH4 A4	1	0,83
		160A	<b>55kW</b>	88 □	LT160 PFH34 T400	1	2,47
Larger enclosure Type appendix +PF3 +PF3/M50	on request on request						
<b>6-pole, padlock device SV4</b> 							
 		20A	<b>7,5kW</b>	64 □	LTS20 PFLH4 A6	1	1,39
		25A	<b>10kW</b>	64 □	LTS25 PFLH4 A6	1	1,39
		32A	<b>12,5kW</b>	64 □	LTS32 PFLH4 A6	1	1,39
		40A	<b>16kW</b>	64 □	LTS40 PFLH4 A6	1	1,39
		63A	<b>22kW</b>	64 □	LTS63 PFLH4 A6	1	1,42
		80A	<b>22kW</b>	64 □	LTS80 PFLH4 A6	1	1,42
knockoutlets M50/40 +PF3/M50	on request						
<b>8-pole, padlock device SV4</b> 							
 		20A	<b>7,5kW</b>	64 □	LTS20 PFLH4 A8	1	1,44
		25A	<b>10kW</b>	64 □	LTS25 PFLH4 A8	1	1,44
		32A	<b>12,5kW</b>	64 □	LTS32 PFLH4 A8	1	1,44
		40A	<b>16kW</b>	64 □	LTS40 PFLH4 A8	1	1,44
		63A	<b>22kW</b>	64 □	LTS63 PFLH4 A8	1	1,50
		80A	<b>22kW</b>	64 □	LTS80 PFLH4 A8	1	1,50
knockoutlets M50/40 +PF3/M50	on request						
<b>Changeover Switch with Padlock Device, lockable</b>							
<b>3-pole, padlock device SV4</b> 							
 		20A	<b>7,5kW</b>	64 □	LTS20 PFLH4 U3	1	1,39
		25A	<b>10kW</b>	64 □	LTS25 PFLH4 U3	1	1,39
		32A	<b>12,5kW</b>	64 □	LTS32 PFLH4 U3	1	1,39
		40A	<b>16kW</b>	64 □	LTS40 PFLH4 U3	1	1,39
		63A	<b>22kW</b>	64 □	LTS63 PFLH4 U3	1	1,42
<b>4-pole, padlock device SV4</b> 							
 		20A	<b>7,5kW</b>	64 □	LTS20 PFLH4 U4	1	1,44
		25A	<b>10kW</b>	64 □	LTS25 PFLH4 U4	1	1,44
		32A	<b>12,5kW</b>	64 □	LTS32 PFLH4 U4	1	1,44
		40A	<b>16kW</b>	64 □	LTS40 PFLH4 U4	1	1,44
		63A	<b>22kW</b>	64 □	LTS63 PFLH4 U4	1	1,50

1) PFL.... larger enclosure

## Emergency-Stop-Main Switches for Panel Mounting, lockable IP66, Type 3R

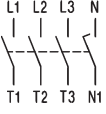
	max. padlocks	AC21 690V	AC23 3x400V	Plate	Type	Pack pcs.	Weighth kg/pcs.
<b>3-pole, padlock device SV1</b> 							
		20A	<b>7,5kW</b>	48 □ <sup>1)</sup>	LTS20 EHN1 A3	1	0,15
		25A	<b>10kW</b>	48 □ <sup>1)</sup>	LTS25 EHN1 A3	1	0,15
		32A	<b>12,5kW</b>	48 □ <sup>1)</sup>	LTS32 EHN1 A3	1	0,15
		40A	<b>16kW</b>	48 □ <sup>1)</sup>	LTS40 EHN1 A3	1	0,15
		63A	<b>22kW</b>	48 □ <sup>1)</sup>	LTS63 EHN1 A3	1	0,17
		80A	<b>22kW</b>	48 □ <sup>1)</sup>	LTS80 EHN1 A3	1	0,17
							
<b>4-pole, padlock device SV1</b> 							
		20A	<b>7,5kW</b>	48 □ <sup>1)</sup>	LTS20 EHN1 A4	1	0,19
		25A	<b>10kW</b>	48 □ <sup>1)</sup>	LTS25 EHN1 A4	1	0,19
		32A	<b>12,5kW</b>	48 □ <sup>1)</sup>	LTS32 EHN1 A4	1	0,19
		40A	<b>16kW</b>	48 □ <sup>1)</sup>	LTS40 EHN1 A4	1	0,19
		63A	<b>22kW</b>	48 □ <sup>1)</sup>	LTS63 EHN1 A4	1	0,21
		80A	<b>22kW</b>	48 □ <sup>1)</sup>	LTS80 EHN1 A4	1	0,21
							
<b>3-pole, padlock device SV4(34)</b> 							
		20A	<b>7,5kW</b>	64 □ <sup>2)</sup>	LTS20 EHN4 A3	1	0,17
		25A	<b>10kW</b>	64 □ <sup>2)</sup>	LTS25 EHN4 A3	1	0,17
		32A	<b>12,5kW</b>	64 □ <sup>2)</sup>	LTS32 EHN4 A3	1	0,17
		40A	<b>16kW</b>	64 □ <sup>2)</sup>	LTS40 EHN4 A3	1	0,17
		63A	<b>22kW</b>	64 □ <sup>2)</sup>	LTS63 EHN4 A3	1	0,19
		80A	<b>22kW</b>	64 □ <sup>2)</sup>	LTS80 EHN4 A3	1	0,19
		85A	<b>30kW</b>	64 □ <sup>2)</sup>	LTS85 EHN4 A3	1	0,39
		100A	<b>37kW</b>	64 □ <sup>2)</sup>	LTS100 EHN4 A3	1	0,39
		125A	<b>45kW</b>	64 □ <sup>2)</sup>	LTS125 EHN4 A3	1	0,39
		160A	<b>55kW</b>	88 □	LT160 EHN34 T300	1	1,16
							
<b>4-pole, padlock device SV4(34)</b> 							
		20A	<b>7,5kW</b>	64 □ <sup>2)</sup>	LTS20 EHN4 A4	1	0,20
		25A	<b>10kW</b>	64 □ <sup>2)</sup>	LTS25 EHN4 A4	1	0,20
		32A	<b>12,5kW</b>	64 □ <sup>2)</sup>	LTS32 EHN4 A4	1	0,20
		40A	<b>16kW</b>	64 □ <sup>2)</sup>	LTS40 EHN4 A4	1	0,20
		63A	<b>22kW</b>	64 □ <sup>2)</sup>	LTS63 EHN4 A4	1	0,23
		80A	<b>22kW</b>	64 □ <sup>2)</sup>	LTS80 EHN4 A4	1	0,23
		85A	<b>30kW</b>	64 □ <sup>2)</sup>	LTS85 EHN4 A4	1	0,44
		100A	<b>37kW</b>	64 □ <sup>2)</sup>	LTS100 EHN4 A4	1	0,44
		125A	<b>45kW</b>	64 □ <sup>2)</sup>	LTS125 EHN4 A4	1	0,44
		160A	<b>55kW</b>	88 □	LT160 EHN34 T400	1	1,55
							

**Add-on modules** see page 297

**Extended Switch Shaft for switches for panel mounting**



type suffix +VW"x"

x = panel thickness

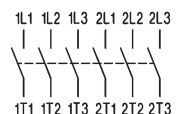

1) Types with padlock device 64 type suffix **64**, ordering example: LTS32 EHN1**64** A3, on request

2) Types with padlock device 88 type suffix **88**, ordering example: LTS32 EHN**88** A3, on request

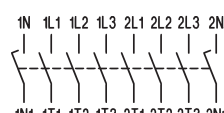

## Emergency-Stop-Main Switches for Panel Mounting, lockable IP66, Type 3R

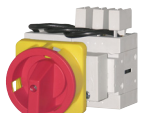
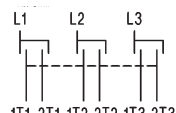
	max. padlocks	AC21 690V	AC23 3x400V	Plate	Type	Pack pcs.	Weight kg/pcs.
<b>6-pole, padlock device SV4</b> 							
		20A	<b>7,5kW</b>	64 □	LTS20 EHN4 A6	1	0,30
		25A	<b>10kW</b>	64 □	LTS25 EHN4 A6	1	0,30
		32A	<b>12,5kW</b>	64 □	LTS32 EHN4 A6	1	0,30
		40A	<b>16kW</b>	64 □	LTS40 EHN4 A6	1	0,30
		63A	<b>22kW</b>	64 □	LTS63 EHN4 A6	1	0,34
		80A	<b>22kW</b>	64 □	LTS80 EHN4 A6	1	0,34
<b>8-pole, padlock device SV4</b> 							
		20A	<b>7,5kW</b>	64 □	LTS20 EHN4 A8	1	0,38
		25A	<b>10kW</b>	64 □	LTS25 EHN4 A8	1	0,38
		32A	<b>12,5kW</b>	64 □	LTS32 EHN4 A8	1	0,38
		40A	<b>16kW</b>	64 □	LTS40 EHN4 A8	1	0,38
		63A	<b>22kW</b>	64 □	LTS63 EHN4 A8	1	0,42
		80A	<b>22kW</b>	64 □	LTS80 EHN4 A8	1	0,42

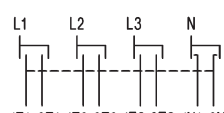
## Changeover Switch with Padlock Device for Panel Mounting, lockable IP66

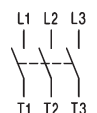

<b>3-pole, padlock device SV4</b> 							
		20A	<b>7,5kW</b>	64 □	LTS20 EHN4 U3	1	0,30
		25A	<b>10kW</b>	64 □	LTS25 EHN4 U3	1	0,30
		32A	<b>12,5kW</b>	64 □	LTS32 EHN4 U3	1	0,30
		40A	<b>16kW</b>	64 □	LTS40 EHN4 U3	1	0,30
		63A	<b>22kW</b>	64 □	LTS63 EHN4 U3	1	0,34
<b>4-pole, padlock device SV4</b> 							
		20A	<b>7,5kW</b>	64 □	LTS20 EHN4 U4	1	0,38
		25A	<b>10kW</b>	64 □	LTS25 EHN4 U4	1	0,38
		32A	<b>12,5kW</b>	64 □	LTS32 EHN4 U4	1	0,38
		40A	<b>16kW</b>	64 □	LTS40 EHN4 U4	1	0,38
		63A	<b>22kW</b>	64 □	LTS63 EHN4 U4	1	0,42

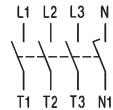
## Main Switches Emergency-Stop for Single Hole Mounting, lockable IP66 Type 4X

	max. padlocks	AC21 690V	AC23 3x400V	Plate	Type	Pack pcs.	Weight kg/pcs.
<b>3-pole, padlock device SV1</b> 							
		20A	<b>7,5kW</b>	48 □	LTS20 ZHN1 A3	1	0,16
		25A	<b>10kW</b>	48 □	LTS25 ZHN1 A3	1	0,16
		32A	<b>12,5kW</b>	48 □	LTS32 ZHN1 A3	1	0,16
		40A	<b>16kW</b>	48 □	LTS40 ZHN1 A3	1	0,16
<b>4-pole, padlock device SV1</b> 							
		20A	<b>7,5kW</b>	48 □	LTS20 ZHN1 A4	1	0,20
		25A	<b>10kW</b>	48 □	LTS25 ZHN1 A4	1	0,20
		32A	<b>12,5kW</b>	48 □	LTS32 ZHN1 A4	1	0,20
		40A	<b>16kW</b>	48 □	LTS40 ZHN1 A4	1	0,20

Add-on modules see page 295

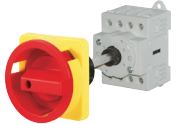
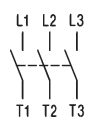
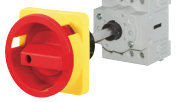
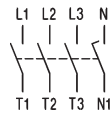
Emergency-Stop-Main Switches, Base Mounting with Door Clutch for Single-Hole Mounting  
 Depth X is adjustable (delivered with X<sub>max</sub> see below), IP66, cUL<sub>us</sub> Type 4X

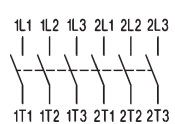
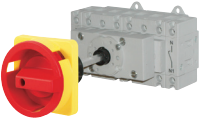
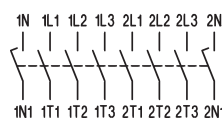
	max. padlocks	AC21 690V	AC23 3x400V	Plate	Type	Pack pcs.	Weight kg/pcs.
<b>3-pole, padlock device SV4</b>							
 	3	20A	<b>7,5kW</b>	64 □	LTSM20 VZVHN4 A3	1	0,19
		25A	<b>10kW</b>	64 □	LTSM25 VZVHN4 A3	1	0,19
		32A	<b>12,5kW</b>	64 □	LTSM32 VZVHN4 A3	1	0,19
		40A	<b>16kW</b>	64 □	LTSM40 VZVHN4 A3	1	0,19
		63A	<b>22kW</b>	64 □	LTS63 VZVHN4 A3	1	0,22
		80A	<b>22kW</b>	64 □	LTS80 VZVHN4 A3	1	0,22
		85A	<b>30kW</b>	64 □	LTS85 VZVHN4 A3	1	0,40
		100A	<b>37kW</b>	64 □	LTS100 VZVHN4 A3	1	0,40
		125A	<b>45kW</b>	64 □	LTS125 VZVHN4 A3	1	0,40
	<b>4-pole, padlock device SV4</b>						
 	3	20A	<b>7,5kW</b>	64 □	LTS20 VZVHN4 A4	1	0,20
		25A	<b>10kW</b>	64 □	LTS25 VZVHN4 A4	1	0,20
		32A	<b>12,5kW</b>	64 □	LTS32 VZVHN4 A4	1	0,20
		40A	<b>16kW</b>	64 □	LTS40 VZVHN4 A4	1	0,20
		63A	<b>22kW</b>	64 □	LTS63 VZVHN4 A4	1	0,26
		80A	<b>22kW</b>	64 □	LTS80 VZVHN4 A4	1	0,26
		85A	<b>30kW</b>	64 □	LTS85 VZVHN4 A4	1	0,45
		100A	<b>37kW</b>	64 □	LTS100 VZVHN4 A4	1	0,45
		125A	<b>45kW</b>	64 □	LTS125 VZVHN4 A4	1	0,45
	<b>6-pole, padlock device SV4</b>						
 	3	20A	<b>7,5kW</b>	64 □	LTS20 VZVHN4 A6	1	0,32
		25A	<b>10kW</b>	64 □	LTS25 VZVHN4 A6	1	0,32
		32A	<b>12,5kW</b>	64 □	LTS32 VZVHN4 A6	1	0,32
		40A	<b>16kW</b>	64 □	LTS40 VZVHN4 A6	1	0,32
		63A	<b>22kW</b>	64 □	LTS63 VZVHN4 A6	1	0,37
		80A	<b>22kW</b>	64 □	LTS80 VZVHN4 A6	1	0,37
	<b>8-pole, padlock device SV4</b>						
 	3	20A	<b>7,5kW</b>	64 □	LTS20 VZVHN4 A8	1	0,34
		25A	<b>10kW</b>	64 □	LTS25 VZVHN4 A8	1	0,34
		32A	<b>12,5kW</b>	64 □	LTS32 VZVHN4 A8	1	0,34
		40A	<b>16kW</b>	64 □	LTS40 VZVHN4 A8	1	0,34
		63A	<b>22kW</b>	64 □	LTS63 VZVHN4 A8	1	0,45
	80A	<b>22kW</b>	64 □	LTS80 VZVHN4 A8	1	0,45	

**Depth**  
 Single Hole Mounting Ø22mm  
 LTS.. VZV..

**4-Hole Mounting**  
 LTS.. V(HN).. (3, 4-pole)

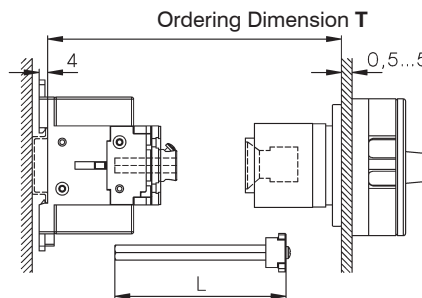
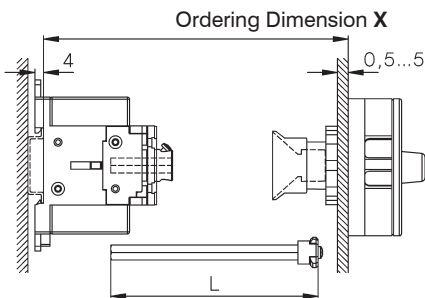



Type		X min	X max	L
LTS20-80 VZV..	3, 4-polig	91 -	190	<b>X - 40±3</b>
LTS20-80 VZV..	6, 8-polig	111 -	190	<b>X - 60±3</b>
LTS85-125 VZV..	3, 4-polig	95-	190	<b>X - 44±3</b>



Type	T min	T max	L	Type	T min	T max
LTS20-80 VH..	111 -	190	<b>T - 60±3</b>	LT160 VH..	120 -	450
LTS85-125 VH..	115 -	190	<b>T - 64±3</b>			

Greater X- and T-Dimensions (max. 380mm for LTS..) on request

Emergency-Stop-Main Switches, Base Mounting with Door Clutch, Padlock Device for 4-Hole Mounting, Depth T is adjustable (delivered with T<sub>max</sub> see page 282), IP66,  $\text{cUL}_{us}$  Type 4X

	max. padlocks	AC21 690V	AC23 3x400V	Schild	Type	Pack pcs.	Weight kg/pcs.
<b>3-pole, padlock device SV4(34)</b> $\square\square\square$							
		20A	<b>7,5kW</b>	64 $\square$ 1)	LTSM20 VHN4 A3	1	0,20
		25A	<b>10kW</b>	64 $\square$ 1)	LTSM25 VHN4 A3	1	0,20
		32A	<b>12,5kW</b>	64 $\square$ 1)	LTSM32 VHN4 A3	1	0,20
		40A	<b>16kW</b>	64 $\square$ 1)	LTSM40 VHN4 A3	1	0,20
		63A	<b>22kW</b>	64 $\square$ 1)	LTS63 VHN4 A3	1	0,24
		80A	<b>22kW</b>	64 $\square$ 1)	LTS80 VHN4 A3	1	0,24
		85A	<b>30kW</b>	64 $\square$ 1)	LTS85 VHN4 A3	1	0,40
		100A	<b>37kW</b>	64 $\square$ 1)	LTS100 VHN4 A3	1	0,40
		125A	<b>45kW</b>	64 $\square$ 1)	LTS125 VHN4 A3	1	0,40
		160A	<b>55kW</b>	88 $\square$	LT160 VHN34 T300	1	1,38
<b>4-pole, padlock device SV4(34)</b> $\square\square\square\square$							
		20A	<b>7,5kW</b>	64 $\square$ 1)	LTS20 VHN4 A4	1	0,21
		25A	<b>10kW</b>	64 $\square$ 1)	LTS25 VHN4 A4	1	0,21
		32A	<b>12,5kW</b>	64 $\square$ 1)	LTS32 VHN4 A4	1	0,21
		40A	<b>16kW</b>	64 $\square$ 1)	LTS40 VHN4 A4	1	0,21
		63A	<b>22kW</b>	64 $\square$ 1)	LTS63 VHN4 A4	1	0,28
		80A	<b>22kW</b>	64 $\square$ 1)	LTS80 VHN4 A4	1	0,28
		85A	<b>30kW</b>	64 $\square$ 1)	LTS85 VHN4 A4	1	0,45
		100A	<b>37kW</b>	64 $\square$ 1)	LTS100 VHN4 A4	1	0,45
		125A	<b>45kW</b>	64 $\square$ 1)	LTS125 VHN4 A4	1	0,45
		160A	<b>55kW</b>	88 $\square$	LT160 VHN34 T400	1	1,77

Emergency-Stop-Main Switches, Base Mounting with Door Clutch for Single-Hole Mounting Depth X is not adjustable, declare depth X when ordering, IP66,  $\text{cUL}_{us}$  Type 4x

<b>3-pole, padlock device SV4</b> $\square\square\square$							
		20A	<b>7,5kW</b>	64 $\square$	LTSM20 VZHN4 A3 X..	1	0,18
		25A	<b>10kW</b>	64 $\square$	LTSM25 VZHN4 A3 X..	1	0,18
		32A	<b>12,5kW</b>	64 $\square$	LTSM32 VZHN4 A3 X..	1	0,18
		40A	<b>16kW</b>	64 $\square$	LTSM40 VZHN4 A3 X..	1	0,18
		63A	<b>22kW</b>	64 $\square$	LTS63 VZHN4 A3 X..	1	0,25
		80A	<b>22kW</b>	64 $\square$	LTS80 VZHN4 A3 X..	1	0,25
<b>4-pole, padlock device SV4</b> $\square\square\square\square$							
		20A	<b>7,5kW</b>	64 $\square$	LTS20 VZHN4 A4 X..	1	0,18
		25A	<b>10kW</b>	64 $\square$	LTS25 VZHN4 A4 X..	1	0,18
		32A	<b>12,5kW</b>	64 $\square$	LTS32 VZHN4 A4 X..	1	0,18
		40A	<b>16kW</b>	64 $\square$	LTS40 VZHN4 A4 X..	1	0,18
		63A	<b>22kW</b>	64 $\square$	LTS63 VZHN4 A4 X..	1	0,25
		80A	<b>22kW</b>	64 $\square$	LTS80 VZHN4 A4 X..	1	0,25

Declare depth X when ordering

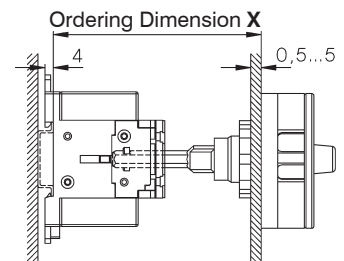

Type	Preferred lengths for X
LTS.. VZH..	80, 85, 104, 129 (tolerance -3, +1,5)





Add-on modules see page 297

1) Types with padlock device 88 r type suffix **88**, ordering example: LTSM32 VHN4**88** A3, on request

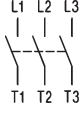
# Emergency-Stop-Main Switches for Distribution Boards, lockable IP40, Open Type

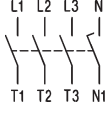
		max. padlocks	AC21 690V	AC23 3x400V	Plate	Type	Pack pcs.	Weight kg/pcs.
<b>3-pole, padlock device SV1</b> 								
			20A	<b>7,5kW</b>	52x45	LTS20 SMAH1(N <sup>2</sup> ) A3	1	0,15
			25A	<b>10kW</b>	52x45	LTS25 SMAH1(N <sup>2</sup> ) A3	1	0,15
			32A	<b>12,5kW</b>	52x45	LTS32 SMAH1(N <sup>2</sup> ) A3	1	0,15
			40A	<b>16kW</b>	52x45	LTS40 SMAH1(N <sup>2</sup> ) A3	1	0,15
			63A	<b>22kW</b>	52x45	LTS63 SMAHN1(N <sup>2</sup> ) A3	1	0,18
			80A	<b>22kW</b>	52x45	LTS80 SMAHN1(N <sup>2</sup> ) A3	1	0,18
			85A	<b>30kW</b>	78x45	LTS85 SMAHN1 A3	1	0,37
	100A	<b>37kW</b>	78x45	LTS100 SMAHN1 A3	1	0,37		
	125A	<b>45kW</b>	78x45	LTS125 SMAHN1 A3	1	0,37		

<b>4-pole, padlock device SV1</b> 								
			20A	<b>7,5kW</b>	52x45	LTS20 SMAHN1(N <sup>2</sup> ) A4	1	0,16
			25A	<b>10kW</b>	52x45	LTS25 SMAHN1(N <sup>2</sup> ) A4	1	0,16
			32A	<b>12,5kW</b>	52x45	LTS32 SMAHN1(N <sup>2</sup> ) A4	1	0,16
			40A	<b>16kW</b>	52x45	LTS40 SMAHN1(N <sup>2</sup> ) A4	1	0,16
			63A	<b>22kW</b>	52x45	LTS63 SMAHN1(N <sup>2</sup> ) A4	1	0,21
			80A	<b>22kW</b>	52x45	LTS80 SMAHN1(N <sup>2</sup> ) A4	1	0,21
			85A	<b>30kW</b>	78x45	LTS85 SMAHN1 A4	1	0,42
	100A	<b>37kW</b>	78x45	LTS100 SMAHN1 A4	1	0,42		
	125A	<b>45kW</b>	78x45	LTS125 SMAHN1 A4	1	0,42		

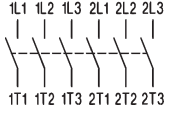
<b>6-pole, padlock device SV1(64)</b> 								
			20A	<b>7,5kW</b>	52x45	LTS20 SMAHN1 A6	1	0,29
			25A	<b>10kW</b>	52x45	LTS25 SMAHN1 A6	1	0,29
			32A	<b>12,5kW</b>	52x45	LTS32 SMAHN1 A6	1	0,29
			40A	<b>16kW</b>	52x45	LTS40 SMAHN1 A6	1	0,29
			63A	<b>22kW</b>	97x45	LTS63 SMAHN1 A6 <sup>1)</sup>	1	0,34
			80A	<b>22kW</b>	97x45	LTS80 SMAHN1 A6 <sup>1)</sup>	1	0,34

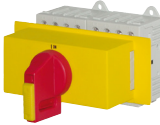
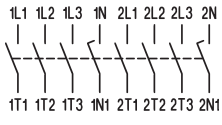
<b>8-pole, padlock device SV164</b> 								
			20A	<b>7,5kW</b>	97x45	LTS20 SMAHN1 A8	1	0,31
			25A	<b>10kW</b>	97x45	LTS25 SMAHN1 A8	1	0,31
			32A	<b>12,5kW</b>	97x45	LTS32 SMAHN1 A8	1	0,31
			40A	<b>16kW</b>	97x45	LTS40 SMAHN1 A8	1	0,31
			63A	<b>22kW</b>	126x45	LTS63 SMAHN1 A8	1	0,42
			80A	<b>22kW</b>	126x45	LTS80 SMAHN1 A8	1	0,42

## Changeover Switch with Padlock Device for Distribution Boards, lockable

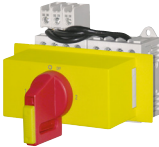
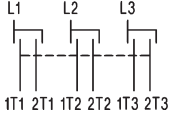

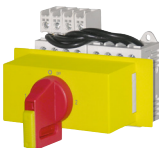
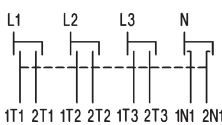
<b>3-pole, padlock device SV164</b> 								
			20A	<b>7,5kW</b>	97x45	LTS20 SMAHN1 U3	1	0,29
			25A	<b>10kW</b>	97x45	LTS25 SMAHN1 U3	1	0,29
			32A	<b>12,5kW</b>	97x45	LTS32 SMAHN1 U3	1	0,29
			40A	<b>16kW</b>	97x45	LTS40 SMAHN1 U3	1	0,29
			63A	<b>22kW</b>	97x45	LTS63 SMAHN1 U3	1	0,34



<b>4-pole, padlock device SV164</b> 								
			20A	<b>7,5kW</b>	97x45	LTS20 SMAHN1 U4	1	0,31
			25A	<b>10kW</b>	97x45	LTS25 SMAHN1 U4	1	0,31
			32A	<b>12,5kW</b>	97x45	LTS32 SMAHN1 U4	1	0,31
			40A	<b>16kW</b>	97x45	LTS40 SMAHN1 U4	1	0,31
			63A	<b>22kW</b>	126x45	LTS63 SMAHN1 U4	1	0,42



1) With padlock device SV164



2) Emergency-Stop-Main Switches for Distribution Boards, lockable with low height handle (10mm), IP40  
i.e. **LTSM40 SMAHN1N A3** or **LTS20 SMAHN1N A4**

Maintenance and Safety Emergency-Stop-Main Switches, in Plastic Enclosure, lockable IP66,  Type 4X



	max. padlocks	AC21 690V	AC23 3x400V	Plate	Type	size	Pack pcs.	Weight kg/Stk.
<b>3-pole, padlock device SV4(34)</b> 								
		20A	<b>7,5kW</b>	64 □	LTSM20 PF(L <sup>1</sup> )HN4 A3	PF1, PFL	1	0,32
		25A	<b>10kW</b>	64 □	LTSM25 PF(L <sup>1</sup> )HN4 A3	PF1, PFL	1	0,32
		32A	<b>12,5kW</b>	64 □	LTSM32 PF(L <sup>1</sup> )HN4 A3	PF1, PFL	1	0,32
		40A	<b>16kW</b>	64 □	LTSM40 PF(L <sup>1</sup> )HN4 A3	PF1, PFL	1	0,32
		63A	<b>22kW</b>	64 □	LTS63 PFLHN4 A3	PFL2	1	0,60
		80A	<b>22kW</b>	64 □	LTS80 PFLHN4 A3	PFL2	1	0,60
		85A	<b>30kW</b>	64 □	LTS85 PFLHN4 A3	PFL2	1	0,78
		100A	<b>37kW</b>	64 □	LTS100 PFLHN4 A3	PFL2	1	0,78
Larger enclosure Type: ..PFL.. on request		125A	<b>45kW</b>	64 □	LTS125 PFLHN4 A3	PFL2	1	0,78
	160A	<b>55kW</b>	88 □	LT160 PFHN34 T300	PF4	1	2,09	



<b>4-pole, padlock device SV4(34)</b> 								
		20A	<b>7,5kW</b>	64 □	LTS20 PF(L <sup>1</sup> )HN4 A4	PF1, PFL	1	0,33
		25A	<b>10kW</b>	64 □	LTS25 PF(L <sup>1</sup> )HN4 A4	PF1, PFL	1	0,33
		32A	<b>12,5kW</b>	64 □	LTS32 PF(L <sup>1</sup> )HN4 A4	PF1, PFL	1	0,33
		40A	<b>16kW</b>	64 □	LTS40 PF(L <sup>1</sup> )HN4 A4	PF1, PFL	1	0,33
		63A	<b>22kW</b>	64 □	LTS63 PFLHN4 A4	PFL2	1	0,64
		80A	<b>22kW</b>	64 □	LTS80 PFLHN4 A4	PFL2	1	0,64
		85A	<b>30kW</b>	64 □	LTS85 PFLHN4 A4	PFL2	1	0,83
		100A	<b>37kW</b>	64 □	LTS100 PFLHN4 A4	PFL2	1	0,83
Larger enclosure Type appendix +PF3 on request		125A	<b>45kW</b>	64 □	LTS125 PFLHN4 A4	PFL2	1	0,83
	+PF3/M50 on request	160A	<b>55kW</b>	88 □	LT160 PFHN34 T400	PF5	1	2,47

<b>6-pole, padlock device SV4</b> 								
 		20A	<b>7,5kW</b>	64 □	LTS20 PFLHN4 A6	PFL2	1	1,39
		25A	<b>10kW</b>	64 □	LTS25 PFLHN4 A6	PFL2	1	1,39
		32A	<b>12,5kW</b>	64 □	LTS32 PFLHN4 A6	PFL2	1	1,39
		40A	<b>16kW</b>	64 □	LTS40 PFLHN4 A6	PFL2	1	1,39
		63A	<b>22kW</b>	64 □	LTS63 PFLHN4 A6	PFL3	1	1,42
		80A	<b>22kW</b>	64 □	LTS80 PFLHN4 A6	PFL3	1	1,42
knockoutlets M50/40 +PF3/M50 on request								

<b>8-pole, padlock device SV4</b> 								
		20A	<b>7,5kW</b>	64 □	LTS20 PFLHN4 A8	PFL3	1	1,44
		25A	<b>10kW</b>	64 □	LTS25 PFLHN4 A8	PFL3	1	1,44
		32A	<b>12,5kW</b>	64 □	LTS32 PFLHN4 A8	PFL3	1	1,44
		40A	<b>16kW</b>	64 □	LTS40 PFLHN4 A8	PFL3	1	1,44
		63A	<b>22kW</b>	64 □	LTS63 PFLHN4 A8	PFL3	1	1,50
		80A	<b>22kW</b>	64 □	LTS80 PFLHN4 A8	PFL3	1	1,50
knockoutlets M50/40 +PF3/M50 on request								









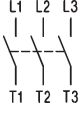

**Changeover Switch with Padlock Device, lockable**

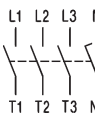
<b>3-pole, padlock device SV4</b> 								
		20A	<b>7,5kW</b>	64 □	LTS20 PFLHN4 U3	PFL3	1	1,39
		25A	<b>10kW</b>	64 □	LTS25 PFLHN4 U3	PFL3	1	1,39
		32A	<b>12,5kW</b>	64 □	LTS32 PFLHN4 U3	PFL3	1	1,39
		40A	<b>16kW</b>	64 □	LTS40 PFLHN4 U3	PFL3	1	1,39
		63A	<b>22kW</b>	64 □	LTS63 PFLHN4 U3	PFL3	1	1,42

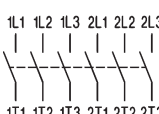

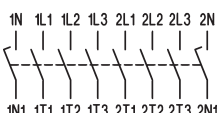
<b>4-pole, padlock device SV4</b> 								
		20A	<b>7,5kW</b>	64 □	LTS20 PFLHN4 U4	PFL3	1	1,44
		25A	<b>10kW</b>	64 □	LTS25 PFLHN4 U4	PFL3	1	1,44
		32A	<b>12,5kW</b>	64 □	LTS32 PFLHN4 U4	PFL3	1	1,44
		40A	<b>16kW</b>	64 □	LTS40 PFLHN4 U4	PFL3	1	1,44
		63A	<b>22kW</b>	64 □	LTS63 PFLHN4 U4	PFL3	1	1,50

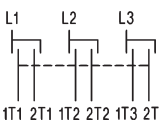
1) PFL.... larger enclosure

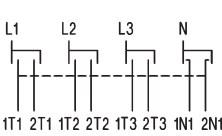



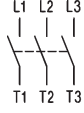

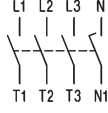
Switch Disconnectors for Panel Mounting, IP66,  Type 3R

		AC21 690V	AC23 3x400V	Plate	Type	Pack pcs.	Weight kg/pcs.
<b>On-Off Switches 3-pole</b>							
 	20A	<b>7,5kW</b>	48 □	LTS20 E A3	1	0,15	
	25A	<b>10kW</b>	48 □	LTS25 E A3	1	0,15	
	32A	<b>12,5kW</b>	48 □	LTS32 E A3	1	0,15	
	40A	<b>16kW</b>	48 □	LTS40 E A3	1	0,15	
	63A	<b>22kW</b>	48 □	LTS63 E A3	1	0,17	
	80A	<b>22kW</b>	48 □	LTS80 E A3	1	0,17	
	85A	<b>30kW</b>	64 □	LTS85 E A3	1	0,39	
	100A	<b>37kW</b>	64 □	LTS100 E A3	1	0,39	
	125A	<b>45kW</b>	64 □	LTS125 E A3	1	0,39	
	160A	<b>55kW</b>	88 □	LT160 E T300	1	1,10	
<b>On-Off Switches 4-pole</b>							
 	20A	<b>7,5kW</b>	48 □	LTS20 E A4	1	0,18	
	25A	<b>10kW</b>	48 □	LTS25 E A4	1	0,18	
	32A	<b>12,5kW</b>	48 □	LTS32 E A4	1	0,18	
	40A	<b>16kW</b>	48 □	LTS40 E A4	1	0,18	
	63A	<b>22kW</b>	48 □	LTS63 E A4	1	0,21	
	80A	<b>22kW</b>	48 □	LTS80 E A4	1	0,21	
	85A	<b>30kW</b>	64 □	LTS85 E A4	1	0,44	
	100A	<b>37kW</b>	64 □	LTS100 E A4	1	0,44	
	125A	<b>45kW</b>	64 □	LTS125 E A4	1	0,44	
	160A	<b>55kW</b>	88 □	LT160 E T400	1	1,50	
<b>On-Off Switches 6-pole</b>							
 	20A	<b>7,5kW</b>	64 □	LTS20 E A6	1	0,30	
	25A	<b>10kW</b>	64 □	LTS25 E A6	1	0,30	
	32A	<b>12,5kW</b>	64 □	LTS32 E A6	1	0,30	
	40A	<b>16kW</b>	64 □	LTS40 E A6	1	0,30	
	63A	<b>22kW</b>	64 □	LTS63 E A6	1	0,36	
	80A	<b>22kW</b>	64 □	LTS80 E A6	1	0,36	
<b>On-Off Switches 8-pole</b>							
 	20A	<b>7,5kW</b>	64 □	LTS20 E A8	1	0,32	
	25A	<b>10kW</b>	64 □	LTS25 E A8	1	0,32	
	32A	<b>12,5kW</b>	64 □	LTS32 E A8	1	0,32	
	40A	<b>16kW</b>	64 □	LTS40 E A8	1	0,32	
	63A	<b>22kW</b>	64 □	LTS63 E A8	1	0,43	
	80A	<b>22kW</b>	64 □	LTS80 E A8	1	0,43	
<b>Changeover Switches 3-pole</b>							
 	20A	<b>7,5kW</b>	64 □	LTS20 E U3	1	0,31	
	25A	<b>10kW</b>	64 □	LTS25 E U3	1	0,31	
	32A	<b>12,5kW</b>	64 □	LTS32 E U3	1	0,31	
	40A	<b>16kW</b>	64 □	LTS40 E U3	1	0,31	
	63A	<b>22kW</b>	64 □	LTS63 E U3	1	0,37	
<b>Changeover Switches 4-pole</b>							
 	20A	<b>7,5kW</b>	64 □	LTS20 E U4	1	0,33	
	25A	<b>10kW</b>	64 □	LTS25 E U4	1	0,33	
	32A	<b>12,5kW</b>	64 □	LTS32 E U4	1	0,33	
	40A	<b>16kW</b>	64 □	LTS40 E U4	1	0,33	
	63A	<b>22kW</b>	64 □	LTS63 E U4	1	0,44	

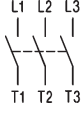
Switch Disconnectors for Single Hole Mounting, lockable IP66, c(UL)<sub>us</sub> Type 4X

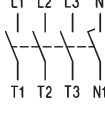
	AC21 690V	AC23 3x400V	Plate	Type	Pack pcs.	Weight kg/pcs.
<b>On-Off Switches 3-pole</b>						
 	20A	<b>7,5kW</b>	48 □	LTS20 Z A3	1	0,16
	25A	<b>10kW</b>	48 □	LTS25 Z A3	1	0,16
	32A	<b>12,5kW</b>	48 □	LTS32 Z A3	1	0,16
	40A	<b>16kW</b>	48 □	LTS40 Z A3	1	0,16
<b>On-Off Switches 4-pole</b>						
 	20A	<b>7,5kW</b>	48 □	LTS20 Z A4	1	0,20
	25A	<b>10kW</b>	48 □	LTS25 Z A4	1	0,20
	32A	<b>12,5kW</b>	48 □	LTS32 Z A4	1	0,20
	40A	<b>16kW</b>	48 □	LTS40 Z A4	1	0,20

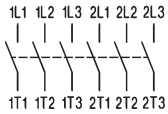
Switch Disconnectors, Base Mounting with Door Clutch for Single-Hole Mounting  
Depth X is adjustable (delivered with X<sub>max</sub> see page 294), IP66, c(UL)<sub>us</sub> Type 4X

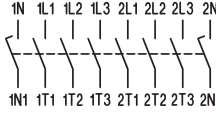
	AC21 690V	AC23 3x400V	Plate	Type	Pack pcs.	Weight kg/pcs.
<b>On-Off Switches 3-pole</b>						
 	20A	<b>7,5kW</b>	64 □	LTSM20 VZV A3	1	0,19
	25A	<b>10kW</b>	64 □	LTSM25 VZV A3	1	0,19
	32A	<b>12,5kW</b>	64 □	LTSM32 VZV A3	1	0,19
	40A	<b>16kW</b>	64 □	LTSM40 VZV A3	1	0,19
	63A	<b>22kW</b>	64 □	LTS63 VZV A3	1	0,22
	80A	<b>22kW</b>	64 □	LTS80 VZV A3	1	0,22
	85A	<b>30kW</b>	64 □	LTS85 VZV A3	1	0,40
	100A	<b>37kW</b>	64 □	LTS100 VZV A3	1	0,40
	125A	<b>45kW</b>	64 □	LTS125 VZV A3	1	0,40
<b>On-Off Switches 4-pole</b>						
 	20A	<b>7,5kW</b>	64 □	LTS20 VZV A4	1	0,20
	25A	<b>10kW</b>	64 □	LTS25 VZV A4	1	0,20
	32A	<b>12,5kW</b>	64 □	LTS32 VZV A4	1	0,20
	40A	<b>16kW</b>	64 □	LTS40 VZV A4	1	0,20
	63A	<b>22kW</b>	64 □	LTS63 VZV A4	1	0,26
	80A	<b>22kW</b>	64 □	LTS80 VZV A4	1	0,26
	85A	<b>30kW</b>	64 □	LTS85 VZV A4	1	0,45
	100A	<b>37kW</b>	64 □	LTS100 VZV A4	1	0,45
	125A	<b>45kW</b>	64 □	LTS125 VZV A4	1	0,45
<b>On-Off Switches 6-pole</b>						
 	20A	<b>7,5kW</b>	64 □	LTS20 VZV A6	1	0,32
	25A	<b>10kW</b>	64 □	LTS25 VZV A6	1	0,32
	32A	<b>12,5kW</b>	64 □	LTS32 VZV A6	1	0,32
	40A	<b>16kW</b>	64 □	LTS40 VZV A6	1	0,32
	63A	<b>22kW</b>	64 □	LTS63 VZV A6	1	0,37
	80A	<b>22kW</b>	64 □	LTS80 VZV A6	1	0,37
<b>On-Off Switches 8-pole</b>						
 	20A	<b>7,5kW</b>	64 □	LTS20 VZV A8	1	0,34
	25A	<b>10kW</b>	64 □	LTS25 VZV A8	1	0,34
	32A	<b>12,5kW</b>	64 □	LTS32 VZV A8	1	0,34
	40A	<b>16kW</b>	64 □	LTS40 VZV A8	1	0,34
	63A	<b>22kW</b>	64 □	LTS63 VZV A8	1	0,45
	80A	<b>22kW</b>	64 □	LTS80 VZV A8	1	0,45

Switch Disconnecter, Base Mounting with Door Clutch for Single-Hole Mounting  
 Depth X is adjustable (delivered with X<sub>max</sub> see below), IP66, c(UL)us Type 4X

Depth  
 Single Hole Mounting Ø22mm  
 LTS.. VZV..

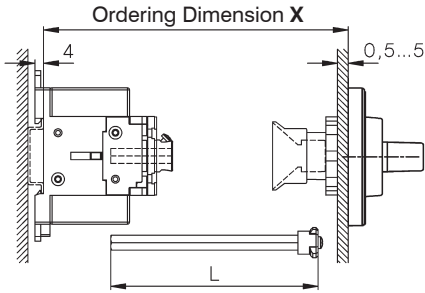

4-Hole Mounting  
 LTS.. V(HN).. (3, 4-pole)

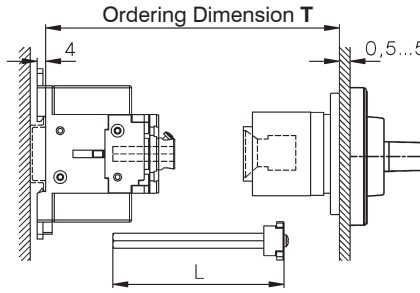

Type	X min	X max	L
LTS(M)20-80 VZV.. 3, 4-polig	91 -	190	X - 40±3
LTS20-80 VZV.. 6, 8-polig	111 -	190	X - 60±3
LTS85-125 VZV.. 3, 4-polig	95 -	190	X - 44±3

Type	T min	T max	L	Type	T min	T max
LTS20-80 V..	111 -	190	T - 60±3	LT160 V..	120 -	450
LTS85-125 V..	115 -	190	T - 64±3			

greater X- and T-Dimensions (max. 380mm for LTS..) on request

Switch Disconnecter, Base Mounting with Door Clutch for Hole Mounting  
 Depth X is adjustable (delivered with T<sub>max</sub> see above), IP66, c(UL)us Type 4X

	max. padlocks	AC21 690V	AC23 3x400V	Plate	Type	Pack pcs.	Weight kg/pcs.
<b>On-Off Switches 3-pole</b>							
		20A	<b>7,5kW</b>	64 □ 1)	LTSM20 V A3	1	0,20
		25A	<b>10kW</b>	64 □ 1)	LTSM25 V A3	1	0,20
		32A	<b>12,5kW</b>	64 □ 1)	LTSM32 V A3	1	0,20
		40A	<b>16kW</b>	64 □ 1)	LTSM40 V A3	1	0,20
		63A	<b>22kW</b>	64 □ 1)	LTS63 V A3	1	0,24
		80A	<b>22kW</b>	64 □ 1)	LTS80 V A3	1	0,24
		85A	<b>30kW</b>	64 □ 1)	LTS85 V A3	1	0,40
		100A	<b>37kW</b>	64 □ 1)	LTS100 V A3	1	0,40
		125A	<b>45kW</b>	64 □ 1)	LTS125 V A3	1	0,40
		160A	<b>55kW</b>	88 □	LT160 V T300	1	1,38

<b>On-Off Switches 4-pole</b>							
		20A	<b>7,5kW</b>	64 □ 1)	LTS20 V A4	1	0,21
		25A	<b>10kW</b>	64 □ 1)	LTS25 V A4	1	0,21
		32A	<b>12,5kW</b>	64 □ 1)	LTS32 V A4	1	0,21
		40A	<b>16kW</b>	64 □ 1)	LTS40 V A4	1	0,21
		63A	<b>22kW</b>	64 □ 1)	LTS63 V A4	1	0,28
		80A	<b>22kW</b>	64 □ 1)	LTS80 V A4	1	0,28
		85A	<b>30kW</b>	64 □ 1)	LTS85 V A4	1	0,45
		100A	<b>37kW</b>	64 □ 1)	LTS100 V A4	1	0,45
		125A	<b>45kW</b>	64 □ 1)	LTS125 V A4	1	0,45
		160A	<b>55kW</b>	88 □	LT160 V T400	1	1,77

Switch Disconnecter, Base Mounting with Door Clutch for Single-Hole Mounting  
 Depth X is not adjustable, declare depth X when ordering, IP66, c(UL)us Type 4X

<b>On-Off Switches 3-pole</b>							
		20A	<b>7,5kW</b>	64 □	LTSM20 VZ A3 X..	1	0,18
		25A	<b>10kW</b>	64 □	LTSM25 VZ A3 X..	1	0,18
		32A	<b>12,5kW</b>	64 □	LTSM32 VZ A3 X..	1	0,18
		40A	<b>16kW</b>	64 □	LTSM40 VZ A3 X..	1	0,18
		63A	<b>22kW</b>	64 □	LTS63 VZ A3 X..	1	0,25
		80A	<b>22kW</b>	64 □	LTS80 VZ A3 X..	1	0,25

1) Types with padlock device 88 type suffix **88**, ordering example: LTS32 V**88** A3, on request

Switch Disconnecter, Base Mounting with Door Clutch for Single-Hole Mounting  
 Depth X is not adjustable, declare depth X when ordering, IP66, cUL<sub>us</sub> Type 4X

	max. padlocks	AC21 690V	AC23 3x400V	Plate	Type	Pack pcs.	Weight kg/pcs.
<b>On-Off Switches 4-pole</b>							
		20A	<b>7,5kW</b>	64 □	LTS20 VZ A4 X..	1	0,18
		25A	<b>10kW</b>	64 □	LTS25 VZ A4 X..	1	0,18
		32A	<b>12,5kW</b>	64 □	LTS32 VZ A4 X..	1	0,18
		40A	<b>16kW</b>	64 □	LTS40 VZ A4 X..	1	0,18
		63A	<b>22kW</b>	64 □	LTS63 VZ A4 X..	1	0,25
		80A	<b>22kW</b>	64 □	LTS80 VZ A4 X..	1	0,25

Declare depth X when ordering

Type	Preference values for X
LTS.. VZ..	80, 85, 104, 129 (tolerance -3, +1,5)

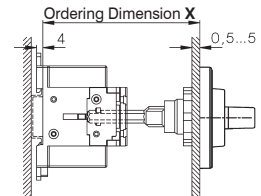

Add-on modules see page 297

Switch Disconnectors for Distribution Boards, IP40, cUL<sub>us</sub> Open Type

	max. padlocks	AC21 690V	AC23 3x400V	Plate	Type	Pack pcs.	Weight kg/pcs.
<b>On-Off Switches 3-pole</b>							
		20A	<b>7,5kW</b>	35x45	LTS20 SMA A3	1	0,15
		25A	<b>10kW</b>	35x45	LTS25 SMA A3	1	0,15
		32A	<b>12,5kW</b>	35x45	LTS32 SMA A3	1	0,15
		40A	<b>16kW</b>	35x45	LTS40 SMA A3	1	0,15
		63A	<b>22kW</b>	52x45	LTS63 SMA A3	1	0,17
		80A	<b>22kW</b>	52x45	LTS80 SMA A3	1	0,17
		85A	<b>30kW</b>	78x45	LTS85 SMA A3	1	0,37
		100A	<b>37kW</b>	78x45	LTS100 SMA A3	1	0,37
	125A	<b>45kW</b>	78x45	LTS125 SMA A3	1	0,37	

	max. padlocks	AC21 690V	AC23 3x400V	Plate	Type	Pack pcs.	Weight kg/pcs.
<b>On-Off Switches 4-pole</b>							
		20A	<b>7,5kW</b>	52x45	LTS20 SMA A4	1	0,16
		25A	<b>10kW</b>	52x45	LTS25 SMA A4	1	0,16
		32A	<b>12,5kW</b>	52x45	LTS32 SMA A4	1	0,16
		40A	<b>16kW</b>	52x45	LTS40 SMA A4	1	0,16
		63A	<b>22kW</b>	52x45	LTS63 SMA A4	1	0,21
		80A	<b>22kW</b>	52x45	LTS80 SMA A4	1	0,21
		85A	<b>30kW</b>	78x45	LTS85 SMA A4	1	0,42
		100A	<b>37kW</b>	78x45	LTS100 SMA A4	1	0,42
	125A	<b>45kW</b>	78x45	LTS125 SMA A4	1	0,42	

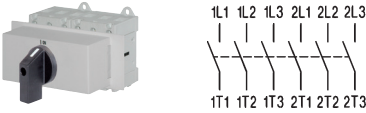

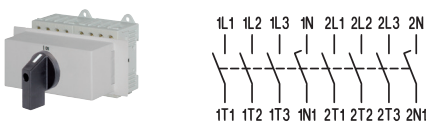

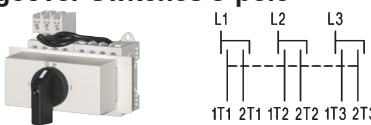

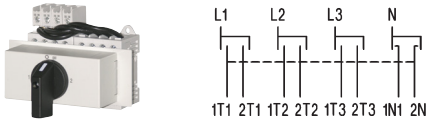

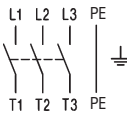

	max. padlocks	AC21 690V	AC23 3x400V	Plate	Type	Pack pcs.	Weight kg/pcs.
<b>On-Off Switches 6-pole</b>							
		20A	<b>7,5kW</b>	52x45	LTS20 SMA A6	1	0,29
		25A	<b>10kW</b>	52x45	LTS25 SMA A6	1	0,29
		32A	<b>12,5kW</b>	52x45	LTS32 SMA A6	1	0,29
		40A	<b>16kW</b>	52x45	LTS40 SMA A6	1	0,29
		63A	<b>22kW</b>	97x45	LTS63 SMA A6	1	0,34
		80A	<b>22kW</b>	97x45	LTS80 SMA A6	1	0,34

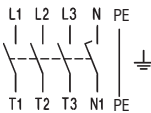
	max. padlocks	AC21 690V	AC23 3x400V	Plate	Type	Pack pcs.	Weight kg/pcs.
<b>On-Off Switches 8-pole</b>							
		20A	<b>7,5kW</b>	97x45	LTS20 SMA A8	1	0,31
		25A	<b>10kW</b>	97x45	LTS25 SMA A8	1	0,31
		32A	<b>12,5kW</b>	97x45	LTS32 SMA A8	1	0,31
		40A	<b>16kW</b>	97x45	LTS40 SMA A8	1	0,31
		63A	<b>22kW</b>	126x45	LTS63 SMA A8	1	0,42
		80A	<b>22kW</b>	126x45	LTS80 SMA A8	1	0,42

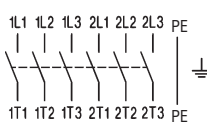
	max. padlocks	AC21 690V	AC23 3x400V	Plate	Type	Pack pcs.	Weight kg/pcs.
<b>Changeover Switches 3-pole</b>							
		20A	<b>7,5kW</b>	97x45	LTS20 SMA U3	1	0,30
		25A	<b>10kW</b>	97x45	LTS25 SMA U3	1	0,30
		32A	<b>12,5kW</b>	97x45	LTS32 SMA U3	1	0,30
		40A	<b>16kW</b>	97x45	LTS40 SMA U3	1	0,30
		63A	<b>22kW</b>	97x45	LTS63 SMA U3	1	0,35

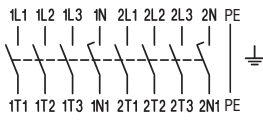

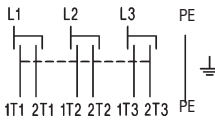

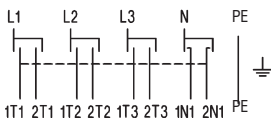







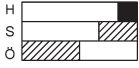

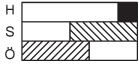
	max. padlocks	AC21 690V	AC23 3x400V	Plate	Type	Pack pcs.	Weight kg/pcs.
<b>Changeover Switches 4-pole</b>							
		20A	<b>7,5kW</b>	97x45	LTS20 SMA U4	1	0,32
		25A	<b>10kW</b>	97x45	LTS25 SMA U4	1	0,32
		32A	<b>12,5kW</b>	97x45	LTS32 SMA U4	1	0,32
		40A	<b>16kW</b>	97x45	LTS40 SMA U4	1	0,32
		63A	<b>22kW</b>	126x45	LTS63 SMA U4	1	0,43

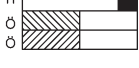
# Switch Disconnectors in Plastic Enclosure IP66, Type 4X



	AC21 690V	AC23 3x400V	Plate	Type	Pack pcs.	Weighth kg/pcs.
<b>On-Off Switches 3-pole</b>  	20A	<b>7,5kW</b>	64 □	LTS20 PF(L <sup>1)</sup> ) A3	1	0,30
	25A	<b>10kW</b>	64 □	LTS25 PF(L <sup>1)</sup> ) A3	1	0,30
	32A	<b>12,5kW</b>	64 □	LTS32 PF(L <sup>1)</sup> ) A3	1	0,30
	40A	<b>16kW</b>	64 □	LTS40 PF(L <sup>1)</sup> ) A3	1	0,30
	63A	<b>22kW</b>	64 □	LTS63 PFL A3	1	0,58
	80A	<b>22kW</b>	64 □	LTS80 PFL A3	1	0,58
	<b>On-Off Switches 4-pole</b>  	20A	<b>7,5kW</b>	64 □	LTS20 PF(L <sup>1)</sup> ) A4	1
25A		<b>10kW</b>	64 □	LTS25 PF(L <sup>1)</sup> ) A4	1	0,31
32A		<b>12,5kW</b>	64 □	LTS32 PF(L <sup>1)</sup> ) A4	1	0,31
40A		<b>16kW</b>	64 □	LTS40 PF(L <sup>1)</sup> ) A4	1	0,31
63A		<b>22kW</b>	64 □	LTS63 PFL A4	1	0,62
80A		<b>22kW</b>	64 □	LTS80 PFL A4	1	0,62
<b>On-Off Switches 6-pole</b>  		20A	<b>7,5kW</b>	64 □	LTS20 PFL A6	1
	25A	<b>10kW</b>	64 □	LTS25 PFL A6	1	1,39
	32A	<b>12,5kW</b>	64 □	LTS32 PFL A6	1	1,39
	40A	<b>16kW</b>	64 □	LTS40 PFL A6	1	1,39
	63A	<b>22kW</b>	64 □	LTS63 PFL A6	1	1,42
	80A	<b>22kW</b>	64 □	LTS80 PFL A6	1	1,42
	knockoutlets M50/40 +PF3/M50 on request					
<b>On-Off Switches 8-pole</b>  	20A	<b>7,5kW</b>	64 □	LTS20 PFL A8	1	1,44
	25A	<b>10kW</b>	64 □	LTS25 PFL A8	1	1,44
	32A	<b>12,5kW</b>	64 □	LTS32 PFL A8	1	1,44
	40A	<b>16kW</b>	64 □	LTS40 PFL A8	1	1,44
	63A	<b>22kW</b>	64 □	LTS63 PFL A8	1	1,50
	80A	<b>22kW</b>	64 □	LTS80 PFL A8	1	1,50
	knockoutlets M50/40 +PF3/M50 on request					
<b>Changeover Switches 3-pole</b>  	20A	<b>7,5kW</b>	64 □	LTS20 PFL U3	1	1,39
	25A	<b>10kW</b>	64 □	LTS25 PFL U3	1	1,39
	32A	<b>12,5kW</b>	64 □	LTS32 PFL U3	1	1,39
	40A	<b>16kW</b>	64 □	LTS40 PFL U3	1	1,39
	63A	<b>22kW</b>	64 □	LTS63 PFL U3	1	1,42
	<b>Changeover Switches 4-pole</b>  	20A	<b>7,5kW</b>	64 □	LTS20 PFL U4	1
25A		<b>10kW</b>	64 □	LTS25 PFL U4	1	1,44
32A		<b>12,5kW</b>	64 □	LTS32 PFL U4	1	1,44
40A		<b>16kW</b>	64 □	LTS40 PFL U4	1	1,44
63A		<b>22kW</b>	64 □	LTS63 PFL U4	1	1,50

1) PFL.... larger enclosure













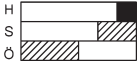

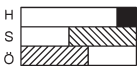
## Add-on Modules for Main Switches, Panel Mounting and Single Hole Mounting

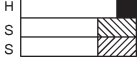
		for switch	Type	Pack pcs.	Weight kg/pcs.	
	<b>4<sup>th</sup> Add-on Neutral Switching Pole</b>					
			LTS20 ... to LTS40 ... LTS63 ... , LTS80 ...	N40E N80E	1 1	0,035 0,042
	<b>Aux. Contact Block 1NO + 1NC</b>					
			LTS20 ... to LTS125 ...	LH11	1	0,02
	<b>Aux. Contact Block 1NO + 1NC Overlapping</b>					
			LTS20 ... to LTS125 ...	LH11X	1	0,02
	<b>Aux. Contact Block 2NC</b>					
			LTS20 ... to LTS125 ...	LH20V/02E	1	0,02
	<b>PE-Terminal</b>					
			LTS20 ... to LTS80 ... LT125 E.. to LT160 E..	PE80E LTXX-E/E	1 1	0,04 0,2
	<b>N-Terminal</b>					
			LTS20 ... to LTS80 ... LT125 E.. to LT160 E..	PEN80E LTXX-N/E	1 1	0,04 0,2
	<b>Terminal Cover 3-pole</b>					
			LTS20 ... to LTS80 ... LTS85.. to LTS125. LT125.. to LT160..	KLAD70 KLAD125 XX-KLAD3	1 1 1	0,005 0,01 0,02
	<b>Terminal Cover for 4<sup>th</sup> pole</b>					
			Mains Load circuit	LTS20 ... to LTS80.. LTS20 ... to LTS80.. KLAD70N KLAD70NI	1 1	0,002 0,002
	<b>Terminal Cover 4-pole</b>					
			LTS85.. to LTS125. LT125.. to LT160..	KLAD125 XX-KLAD4	1 1	0,01 0,02

## Accessories for Main Switches, Panel Mounting, Single Hole and Base Mounting

		for switch	Type	Pack pcs.	Weight kg/pcs.	
	<b>Additional Escutcheon Plate Yellow, Marked with: HAUPTSCHALTER</b>					
		for plate 48 □ for plate 64 □	LTS(M).. .HN1.. LTS(M).. .HN4..	A91501 E91501	1 1	0,003 0,005
	<b>Additional Escutcheon Plate Yellow, Marked with: MAIN SWITCH</b>					
		for plate 48 □ for plate 64 □	LTS(M).. .HN1.. LTS(M).. .HN4..	A91524 E91524	1 1	0,003 0,005
	<b>Tab Terminal 6,3 x 0,8mm</b>					
			LTS(M)20.. to LTS(M)40..	LG11073	10	0,001

## Add-on Modules for Main Switches, Base and Rail Mounting

		for switch	Type	Pack pcs.	Weight kg/pcs.
	<b>4<sup>th</sup> Add-on Neutral Switching Pole</b>				
		LTS20 ... , LTS40 ... LTS63 ... , LTS80 ...	N40V N80V	1 1	0,035 0,042
	<b>Aux. Contact Block 1NO + 1NC</b>				
		LTS(M)20 ... to LTS125 ...	LH11	1	0,02
	<b>Aux. Contact Block 1NO + 1NC Overlapping</b>				
		LTS(M)20 ... to LTS125 ...	LH11X	1	0,02
	<b>Aux. Contact Block 2NO</b>				
		LTS(M)20 ... to LTS80 ...	LH20V/02E	1	0,02
	<b>PE-Terminal</b>				
		LTS(M)20 ... to LTS80 ... LT125 .. to LT160 ..	PE80V LTXX-E/V	1 1	0,04 0,2
	<b>N-Terminal</b>				
		LTS20 ... to LTS80 ... LT125 .. to LT160 ..	PEN80V LTXX-N/V	1 1	0,04 0,2
	<b>Terminal Cover 3-pole</b>				
		LTSM20 ... to LTSM40 ...	KLAD40M	1	0,005
		LTS20 ... to LTS40 ...	KLAD40	1	0,005
		LTS63 ... to LTS80 ...	KLAD70	1	0,005
		LTS85.. to LTS125. LT125.. to LT160..	KLAD125 XX-KLAD3	1 1	0,01 0,02
	<b>Terminal Cover for 4<sup>th</sup> pole</b>				
	Mains Load circuit	LTS63.., LTS80.. LTS63.., LTS80..	KLAD70N KLAD70NI	1 1	0,002 0,002
	<b>Terminal Cover 4-pole</b>				
		LTS20 ... to LTS40 ...	KLAD40	1	0,005
		LTS85.. to LTS125. LT125.. to LT160..	KLAD125 XX-KLAD4	1 1	0,01 0,02
	<b>Additional Cover SMA for</b>				
	4. Pole	N40V, N80V	grey	LG8628-2	1 0,047
	Aux. Contacts PE and N-Terminal	LH.. PE80V, PEN80V	yellow	LG8628-7	1 0,047

# Technical Data

Data according to IEC 947-3, IEC 947-5-1, VDE 0660, EN 60947-3, EN 60947-5-1

Type	LTS(M)20	LTS(M)25	LTS(M)32	LTS(M)40	LTS63	LTS80	LTS85	LTS100	LTS125	LT160	
<b>Main contacts</b>											
Rated thermal current I <sub>th</sub> open	A	20	25	32	40	63	80	85	100	125	160
Rated thermal current I <sub>the</sub> enclosed	A	20	25	32	40	63	80	85	100	110	160
Rated insulation voltage U <sub>i</sub> 1)	V	690	690	690	690	690	690	1000 <sup>3)</sup>	1000 <sup>3)</sup>	1000 <sup>3)</sup>	1000 <sup>3)</sup>
Rated operational current I <sub>e</sub> AC21A	A	20	25	32	40	63	80	85	100	125	160
Rated operational voltage U <sub>e</sub> max. AC21A	V	690	690	690	690	690	690	1000	1000	1000	690
Making capacity I <sub>eff</sub> 3x380-440V	A	160	190	220	300	370	440	600	725	850	1050
Breaking capacity 3x220-240V	A	160	180	200	250	330	380	480	580	680	900
3x380-440V	A	160	180	200	250	330	380	480	580	680	850
3x660-690V	A	80	110	140	170	190	220	250	330	420	340
Disconnection property performed up to	V	690	690	690	690	690	690	1000	1000	1000	1000
Motor Switch AC3 3x400V	A	12	16	23	30	37	37	45	60	72	85
Motor Switch AC3 3x220-240V	kW	3	4	5,5	7,5	11	11	15	18,5	22	30
Direct switching of single motors 3x380-440V	kW	5,5	7,5	11	15	18,5	18,5	22	30	37	45
3x660-690V	kW	5,5	7,5	11	15	18,5	18,5	22	30	37	45
Main Switch AC23 3x400V	A	16	20	25	32	45	45	60	72	85	110
Motor Switch, AC23A, 3x220-240V	kW	4	5,5	7,5	9	15	15	18,5	22	30	30
Main Switch, AC23B 3x380-440V	kW	7,5	10	12,5	16	22	22	30	37	45	55
Safety Switch 3x660-690V	kW	5,5	7,5	11	15	18,5	18,5	22	30	37	37
Rated conditional short-circuit current 400V	kA <sub>eff</sub>	10	10	10	10	10	10	10	10	5	30
Max. fuse size gL (gG) 400V	A	25	35	40	40	63	80	100	100	125	160
Rated conditional short-circuit current 690V	kA <sub>eff</sub>	10	5	3	1	5	1,5	10	10	5	30
Max. fuse size gL (gG) 690V	A	20	25	32	40	63	80	85	100	125	-
Mechanical life x10 <sup>3</sup>		200	200	200	200	100	100	100	100	100	100
Electrical life x10 <sup>3</sup>		5	5	5	5	4	4	3	3	3	2
Rated short-time withstand current (1sec. current)	A	250	300	400	500	600	850	1000	1200	1500	3000
Power loss per pole AC21 = I <sub>th</sub>	P/pole [W]	E, Z 0,322	0,503	0,824	1,288	2,739	4,416	3,851	5,330	8,328	-
	V, SMA, PF	0,364	0,569	0,933	1,458	2,739	4,416	3,851	5,330	8,328	-
	R/pole [mOhm]	E, Z 0,805	0,805	0,805	0,805	0,690	0,690	0,533	0,533	0,533	-
	V, SMA, PF	0,911	0,911	0,911	0,911	0,690	0,690	0,533	0,533	0,533	-
<b>Maximum ambient temperature</b> Operation open		-40°C to +60°C (90°C) <sup>5)</sup>									+60°C
	enclosed	-40°C to +40°C									+40°C
	Storage	-50°C to +90°C <sup>6)</sup>									+90°C <sup>6)</sup>
<b>Cable cross sections</b> solid or stranded	mm <sup>2</sup>	0,5 - 10			1 - 25 <sup>4)</sup>			4 - 50			max.95
	AWG	20 - 8 (10)			16 - 3 (10)			10 - 00 (10)			max.3/0
flexible	mm <sup>2</sup>	0,5 - 6			4 - 16 <sup>4)</sup>			10 - 35			max.70
	AWG	20 - 10			16 - 6			8 - 2			max.2/0
flexible (+ multicore cable end)	mm <sup>2</sup>	0,5 - 6			0,75 - 16 <sup>4)</sup>			6 - 35			max.50
	AWG	20 - 10			16 - 6			8 - 2			max.1/0
Size of terminal screw		M3,5			M5			M6			M10
Tightening torque	Nm	1 - 1,7			2,8 - 4			1,7 - 4,5			14
<b>Auxiliary contacts</b>											
Rated insulation voltage U <sub>i</sub> 1)	V	690				690			690		690
Rated thermal current I <sub>th</sub> , I <sub>the</sub>	A	10				10			10		16
Switching capacity AC15 380-450V	A	2,5/1,5				2,5/1,5			2,5/1,5		6/4
DC13 60-110V	A	2/0,4				2/0,4			2/0,4		-
Rated conditional short-circuit current	kA <sub>eff</sub>	3				3			3		3
Max. short circuit protection gL (gG)	A	10				10			10		16
<b>Cable cross sections</b> solid or stranded	mm <sup>2</sup>	0,75 - 2,5			0,75 - 2,5			0,75 - 2,5			max.4
	AWG	14 - 12			14 - 12			14 - 12			max.12
flexible (+ multicore cable end)	mm <sup>2</sup>	0,75 - 2,5 (1,5)			0,75 - 2,5 (1,5)			0,75 - 2,5 (1,5)			max.2,5
	AWG	18 - 14			18 - 14			18 - 14			max.14
<b>Data according to UL and cUL</b>											
Type	LTS(M)20	LTS(M)25	LTS(M)32	LTS(M)40	LTS63	LTS80	LTS85	LTS100	LTS125	LT160	
Rated voltage	V	600	600	600	600	600	600	600	600	600	
Ampere-Rating "General use"	A	20	25	32	40	63	80	85	100	125	
DOL-Rating 3-phase 110-120V	HP	1	1,5	2	2	3	5	7,5	10	15	
220-240V	HP	3	5	5	5	10	10	20	25	30	
440-480V	HP	7,5	10	10	15	20	20	40	50	60	
550-600V	HP	10	10	15	15	25	25	50	60	60	
DOL-Rating 1-phase (2-pole break) 110-120V	HP	1	1	1	1	2	2	3	5	7,5	
200-208V	HP	1	2	2	2	3	3	7,5	10	10	
220-240V	HP	2	2	3	3	5	5	10	15	15	
Fuse size (RK5) Manual Motor Controller	A	40	50	50	70	90	110	125	125	125	
5kA / 600V Motor Disconnect	A	40	50	50	50	70	70	125	125	125	
Tightening torque	Nm	1,7	1,7	1,7	1,7	2,8-4	2,8-4	1,7-4,5	1,7-4,5	1,7-4,5	

1) suitable for: earthed-neutral systems, overvoltage category I to III, pollution degree 3 (standard-industry): U<sub>imp</sub> = 6kV.

2) Fuse RK1 / 10kA / 600V

3) U<sub>imp</sub> = 8kV

4) LTS63..U. stranded 16mm<sup>2</sup>, flexible 10mm<sup>2</sup>

5) Derating acc. to cable cross sections

6) for switches with transparent plates 48 □ max. +65°C

# Dimensions (mm)

## Main Switches, Switch Disconnectors LT(S)..

**Panel mounting LT(S).. E(HN)..**  
ON-OFF Switches 3-pole, 4-pole

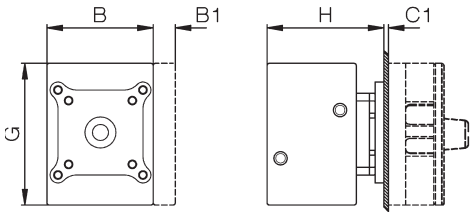

ON-OFF Switches 6-pole, 8-pole  
Changeover Switches 3-pole, 4-pole

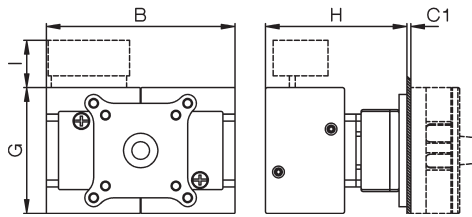

Mounting holes  
Mounting screw: J3631N M=1,2-1,4 Nm

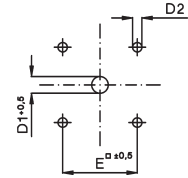

**Single hole mounting LTS.. Z(HN)..**  
ON-OFF Switches 3-pole, 4-pole

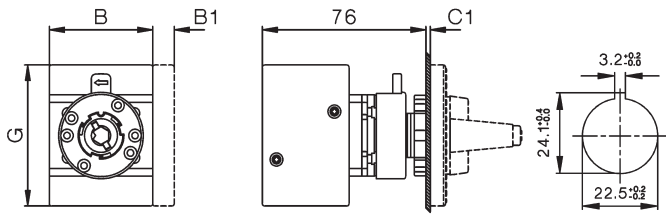

Mounting holes

**Mounting of add-on modules LTS20 - LTS80**  
Panel mounting, Single hole mounting

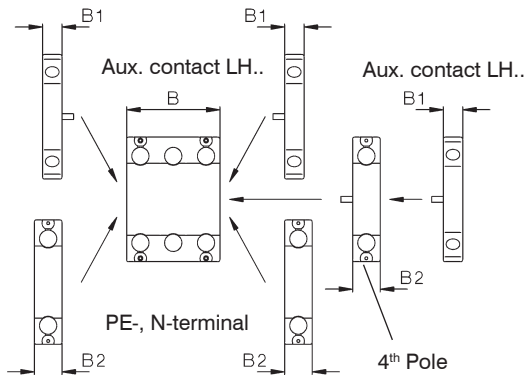

Type	Esc. plate	Changeover ON-OFF	Changeover ON-OFF		3-pole 6-pole	4-pole 8-pole	aux. contact	4. Pole PE		D1	D2	E	F	G	H	H	I
			3-pole	4-pole				B2	C1								
LTS20-80..	48 □, SV1	padlock device	A	B	B	B	B1	B2	C1	D1	D2	E	F	G	H	H	I
LTS20-80..	64 □, SV4, SV164		A	B	B	B	B1	B2	C1	D1	D2	E	F	G	H	H	I
LTS85-125..	64 □, SV4	padlock device	A	B	B	B	B1	B2	C1	D1	D2	E	F	G	H	H	I
LTS85-125..	88 □, SV488		A	B	B	B	B1	B2	C1	D1	D2	E	F	G	H	H	I
LT160	88 □, SV34	padlock device	A	B	B	B	B1	B2	C1	D1	D2	E	F	G	H	H	I

**Escutcheon plate**  
48 □

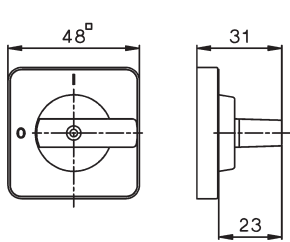

64 □

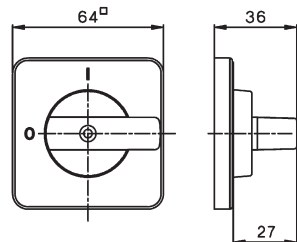

**Padlock devices**  
SV1

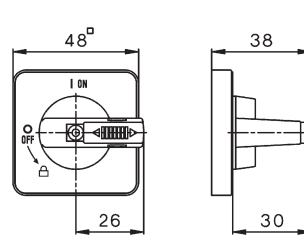

SV164

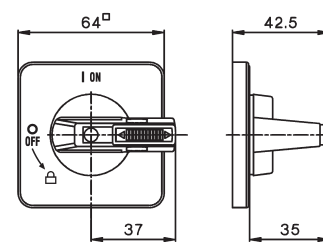

**Padlock devices**  
SV4

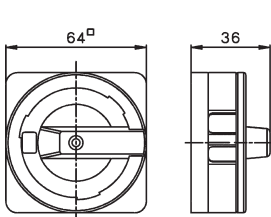

SV488

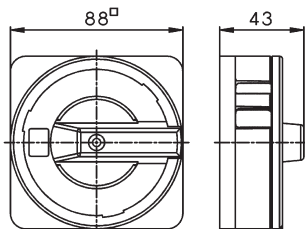

SV34

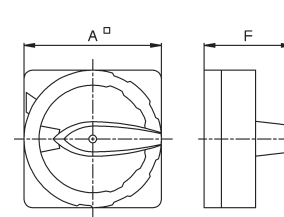

**Extended Switch Shaft**  
+ VW"x"

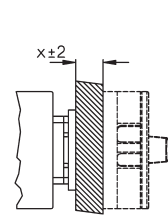

# Dimensions (mm)

## Main Switches, Switch Disconnectors LT(S)..

**Base mounting LTS.. VZV(HN)..**  
ON-OFF Switches 3-pole, 4-pole

$L = X - 40 \pm 3$  for LTS20 - 80  
 $L = X - 44 \pm 3$  for LTS85 - 125

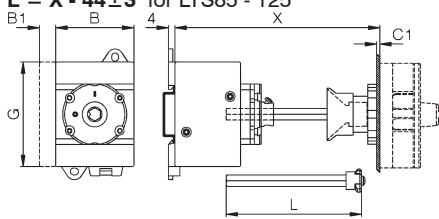

6-pole  
for LTS20 - 40 only  
 $L = X - 40 \pm 3$

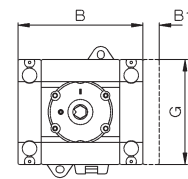

ON-OFF Switches 6-pole, 8-pole  
Changeover Switches 3-pole, 4-pole  
 $L = X - 60 \pm 3$

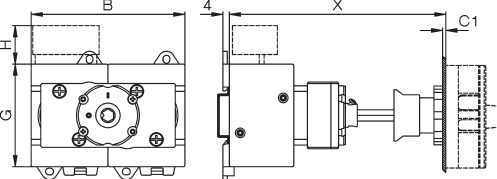

Mounting holes

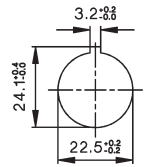

**Base mounting LT(S).. V(HN)..**  
ON-OFF Switches 3-pole, 4-pole

$L = T - 60 \pm 3$  for LTS20 - 80  
 $L = T - 64 \pm 3$  for LTS85 - 125

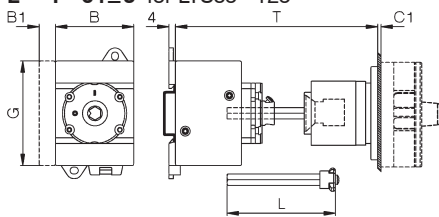

6-pole  
for LTS20 - 40 only  
 $L = T - 60 \pm 3$

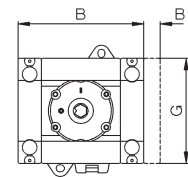

ON-OFF Switches 6-pole, 8-pole  
Changeover Switches 3-pole, 4-pole  
 $L = T - 80 \pm 3$  for LTS20 - 80 only

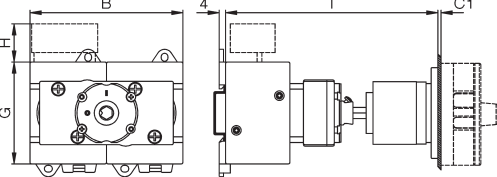

Mounting holes

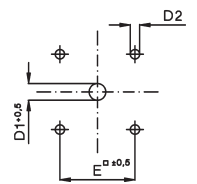

**Base mounting LTS.. VZ(HN)..**  
ON-OFF Switches 3-pole, 4-pole  
Preference values for X: 80, 85, 104, 129

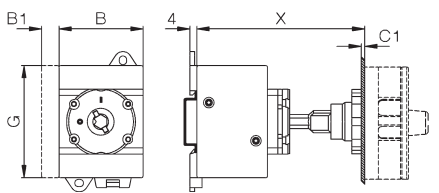

6-pole  
for LTS20 - 40 only

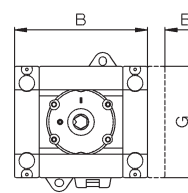

ON-OFF Switches 6-pole, 8-pole  
Changeover Switches 3-pole, 4-pole

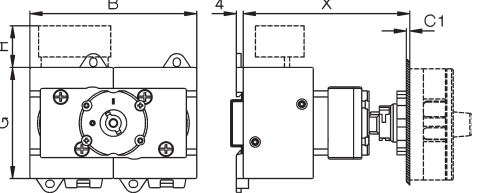

Mounting holes

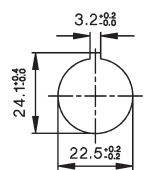

Type	Changeover ON-OFF Escutch. plate or padlock device	3,4-pole					aux. contact B1	4 Pole PE		C1	D1	D2	D3	E	G	K	K1	J
		A	B	B	B	B		B2	H									
LTS20 -40	64 □, SV4, SV164	64	48	48	77	97	10	14,5	24	1-5	9	5	M4	48	64	25	48	70
LTS63, 80	64 □, SV4, SV164	64	48	62,5	97	126	10	14,5	24	1-5	9	5	M4	48	64	25	48	70
LTS85-125..	64 □, SV4	64	78	78	-	-	10	-	-	1-5	9	5	M4	48	85	38	-	90
LT125/160	88 □, SV34	88	112	150	224	-	-	-	-	1-4	13/27 <sup>2)</sup>	6	M6	68	108	36	-	120

**Base mounting**  
ON-OFF Switches LTS20 - LTS80  
3-pole, 4-pole  
6-pole LTS20 -40

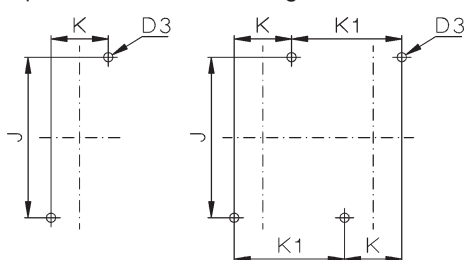

LTS85-125, LT160  
3-pole, 4-pole

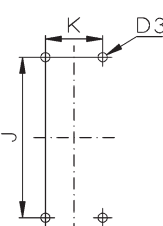

**Mounting of Accessories LTS20 - LTS80**  
Base mounting, for distribution boards

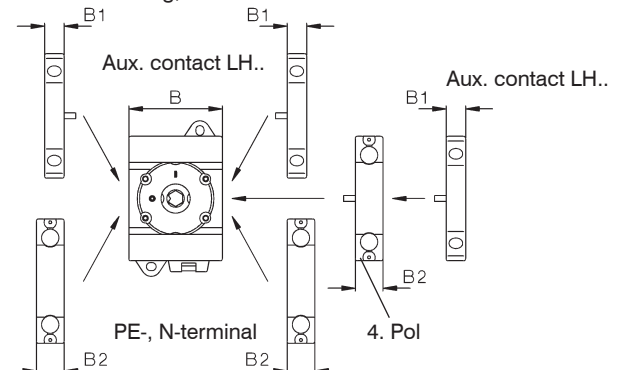

1) Ø 22-25 for LT80(100) VH(N)34 .. only  
2) Ø 26-30 for LT125(160) VH(N)34 .. only

## Dimensions (mm)

### Main Switches, Switch Disconnectors LT(S)..

#### Installation cover LT(S).. SMA(HN)..

ON-OFF Switches 3-pole, 4-pole

ON-OFF Switches 6-pole  
for LTS20 - 40 only

ON-OFF Switches 6-pole, 8-pole  
Changeover Switches 3-pole, 4-pole

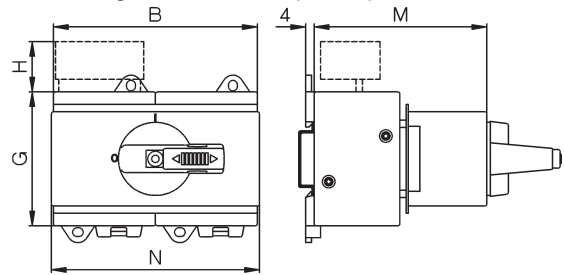
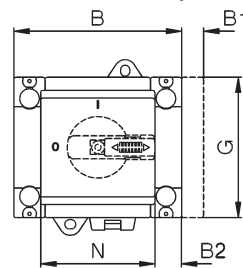
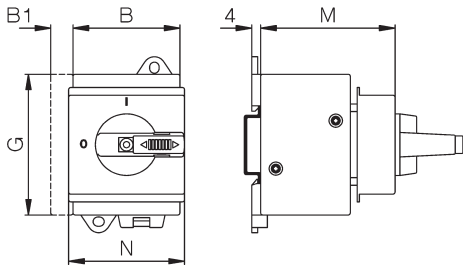

Type	padlock device	Changeover ON-OFF								G	U3/U4				H				
		A3	A4	A6	A8	U3	U4	aux. contact	4.pole PE		A3	A6	A8	U3		U4			
LTS20 - 40	SV1, SV164	48	48	77	96	96	96	10	14,5	64	60	60	74	52	52	97 <sup>2)</sup>	97 <sup>2)</sup>	97 <sup>2)</sup>	24
LTS63, 80	SV1, SV164	48	62,5	96	125	96	125	10	14,5	64	60	79	79	52	97 <sup>2)</sup>	126 <sup>1)</sup>	97 <sup>2)</sup>	126 <sup>1)</sup>	-
LTS85-125..	SV164	78	78	-	-	-	-	10	-	85	60	-	-	78	-	-	-	-	-

#### Installation cover with low height handle LTS SMAHN1.. +SV1N

Main switch 3-pole, 4-pole

LTS20 - LTS80

Padlock device SV1

Padlock device SV164

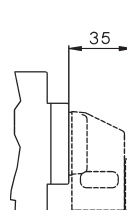
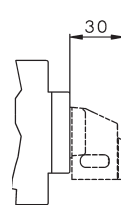
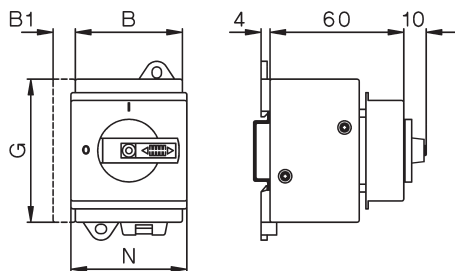

1) Original cover

2) Remove cover parts

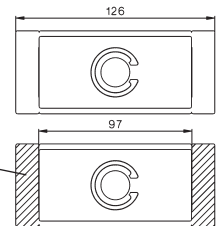

### Maintenance and Safety Switches LT(S)..PF..

Type	pole	size	A	B	C	D1	D2	E	F	H
LTS(M)20 PFH.. A. - LTS(M)40 PFH.. A. <sup>3)</sup>	3, 4	PF1	130	98	120	2x25,5/20,5	-	75	100	76
LTS20 PFLH.. A., LTS40 PFLH A. <sup>3)</sup>	3, 4	PFL	180	98	170	2x25,5/20,5 / 16,5/12,5-	-	75	150	76
LTS20 PFLH.. A. - LTS40 PFLH.. A. <sup>4)</sup>	6	PFL2	200	140	188,5	40,5/32,5+16,5+12,5 -	-	100	160	86
LTS63 PFLH.. A. - LTS80 PFLH.. A. <sup>4)</sup>	3, 4	PFL2	200	140	188,5	40,5/32,5+16,5+12,5 -	-	100	160	86
LTS85 PFLH.. A. - LTS125 PFLH.. A. <sup>5)</sup>	3, 4	PFL2	200	140	188,5	40,5/32,5+16,5+12,5 -	-	100	160	86
suffix + PF3	3, 4	PFL3	240	176	228,5	2x40,5/32,5	-	120	200	120
suffix + PF3/M50	3, 4	PFL3	240	176	228,5	50,5/40,5	-	120	200	120
LTS20 PFLH.. A. - LTS40 PFLH.. A. <sup>5)</sup>	8	PFL3	240	176	228,5	2x40,5/32,5	-	120	200	120
LTS63 PFLH.. A. - LTS80 PFLH.. A. <sup>5)</sup>	6, 8	PFL3	240	176	228,5	2x40,5/32,5	-	120	200	120
suffix + M50	6, 8	PFL3	240	176	228,5	50,5/40,5	-	120	200	120
LT160 PF..	3	PF4	300	200	-	2x50,5	25,5	172	272	172
LT160 PF..	4	PF5	300	280	-	2x50,5	-	254	254	180

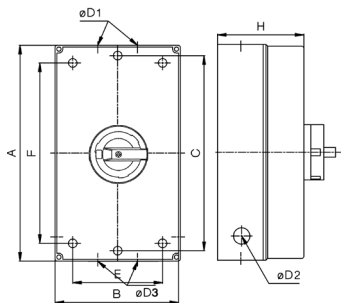

### Switch Disconnectors in Plastic Enclosure LTS..PF..

Type	pole	size	A	B	C	D1	E	F	H
LTS20 PF A., LTS40 PF A. <sup>3)</sup>	3, 4	PF1	130	98	121	2x25,5/20,5	75	100	76
LTS20 PFL A., LTS40 PFL A. <sup>3)</sup>	3, 4	PFL	180	98	170	2x25,5/20,5 / 16,5/12,5	75	150	76
LTS63 PFL A., LTS80 PFL A. <sup>4)</sup>	3, 4	PFL2	200	140	188,5	40,5/32,5+16,5+12,5	100	160	86
suffix + PF3	3, 4	PFL3	240	176	228,5	2x40,5/32,5	120	200	120
suffix + PF3/M50	3, 4	PFL3	240	176	228,5	50,5/40,5	120	200	120

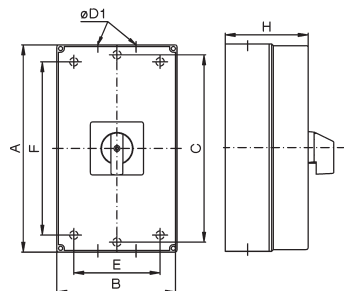

Max. quantity of poles + aux. contacts in enclosure:

3) LTS40 PF. A5 + LH11

4) LTS40 PFL.. A6, LTS80 PFL.. A5 + LH11, LTS125 PFL.. A4 + LH11

5) LTS40 PFL.. A10, LTS40 PFL.. U4 + LH11, LTS80 PFL.. A8, LTS80 PFL.. A6 + LH11, LTS40 PFL.. U3 + LH11, LTS125 PFL.. A4+LH11

## Dimensions (mm)

### Main Switches, Switch Disconnectors LTSM..

#### For Distribution Boards LTSM.. SMA A3

ON-OFF-Switches 3-pole

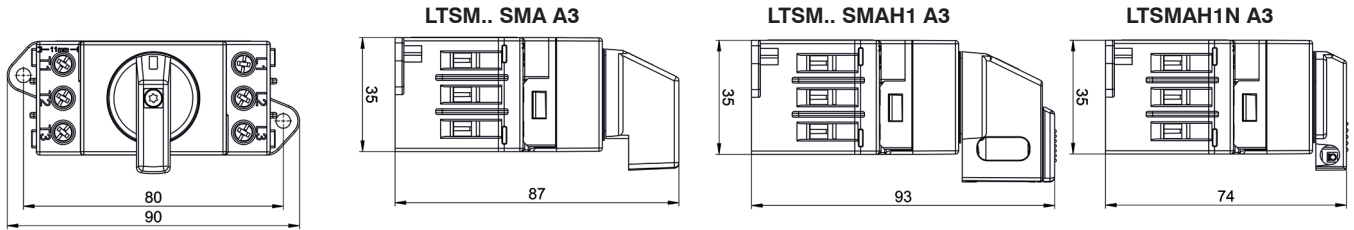

#### Base Mounting LTSM.. V A3

ON-OFF-Switches 3-pole

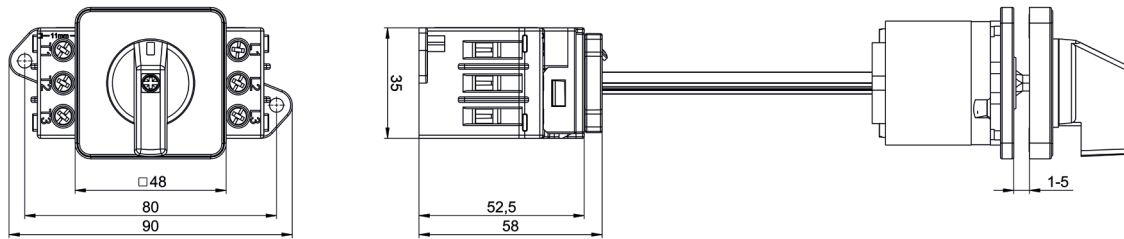

#### Base Mounting LTSM.. V A3 +GFP

ON-OFF-Switches 3-pole

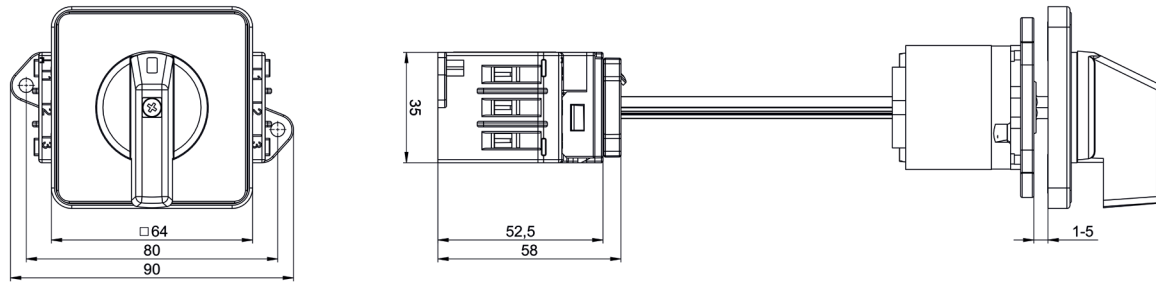

#### Base Mounting LTSM.. VH(N)488 A3

ON-OFF-Switches 3-pole

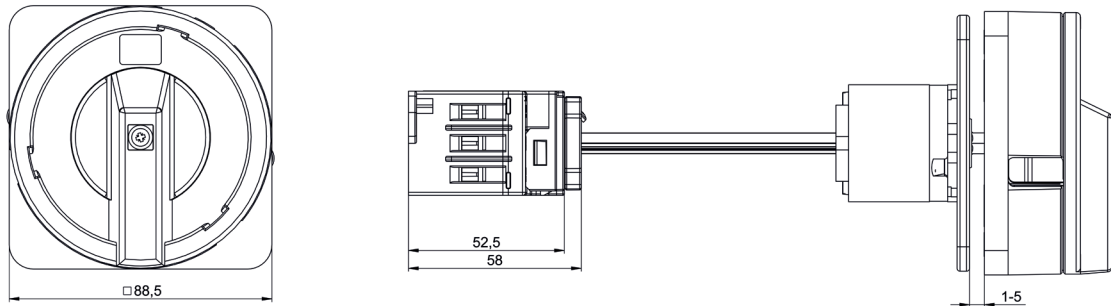

#### Base Mounting LTSM.. VH1 A3

ON-OFF-Switches 3-pole

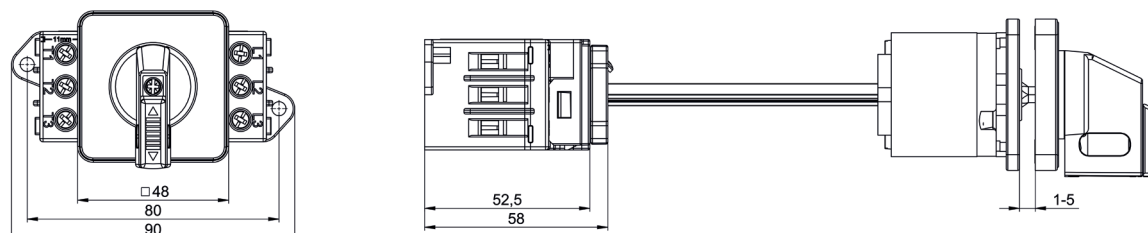

**Base Mounting LTSM.. VH4 A3**  
ON-OFF-Switches 3-pole

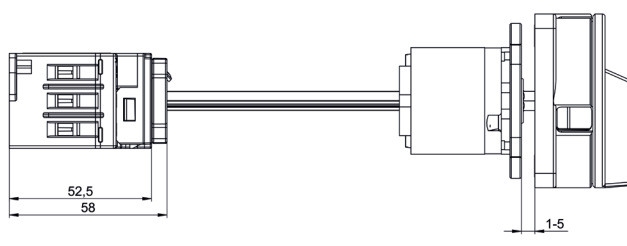
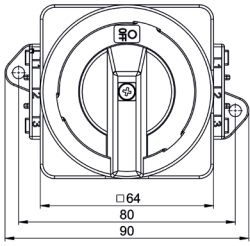

**Base Mounting LTSM.. VH164 A3**  
ON-OFF-Switches 3-pole

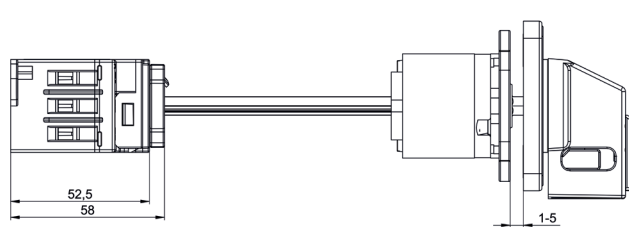
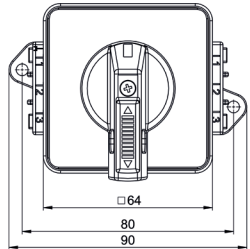

**LTSM VZV164 A3**

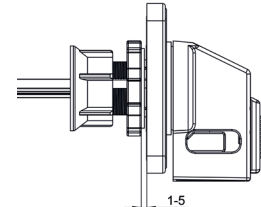

**Base Mounting LTSM.. VZV A3**  
ON-OFF-Switches 3-pole

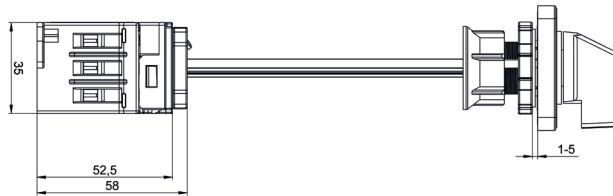
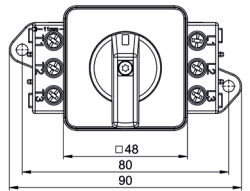

**Base Mounting LTSM.. VZV A3 +GFP**  
ON-OFF-Switches 3-pole

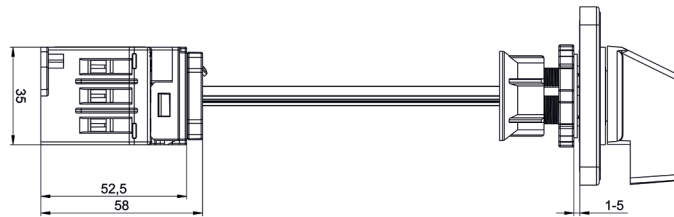
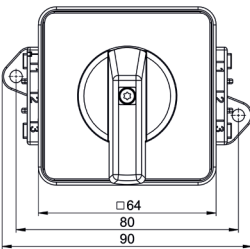

**Base Mounting LTSM.. VZVH1 A3**  
ON-OFF-Switches 3-pole

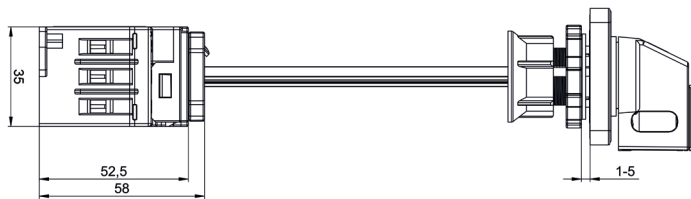
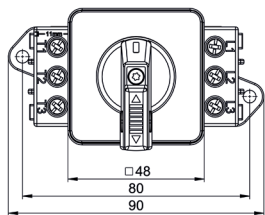

**Base Mounting LTSM.. VZVH4 A3**  
ON-OFF-Switches 3-pole

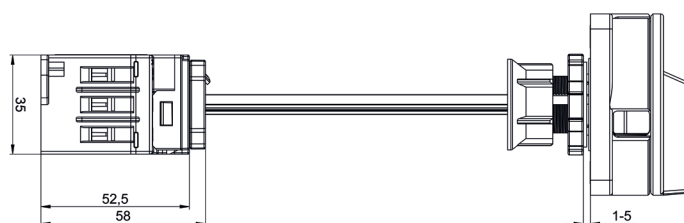
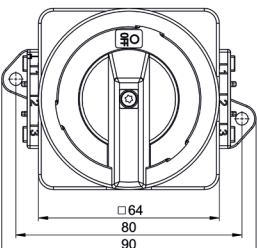

**Index**

Page



ON-OFF Switches for Panel Mounting

306



ON-OFF Switches for Single Hole Mounting

307



ON-OFF Switches for Base Mounting with Door Clutch

308



ON-OFF Switches for Distribution Boards

309



Main Switches for Panel Mounting

310



Main Switches for Single Hole Mounting

311



Main Switches for Base Mounting with Door Clutch

312



Main Switches for Distribution Boards

313



Main Switches in Plastic Enclosure

314



Technical Datas  
Approvals

315

319

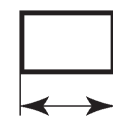

Dimensions

321

Contactors, Motor-Starter

Circuit Breakers

Manual Motor-Starters

Switches

AC-Main Switches

DC-Switch Disconnectors

Push Buttons

Representatives, Suppliers

Ratings				DC-Switch Disconnectors			
Type	I <sub>th</sub> open A	DC21B(DC-PV1) at U <sub>e</sub>		Design			
		I <sub>th</sub> open A	4 poles in series V	Panel mounting 4-hole mounting IP66 <sup>1)</sup> cULus Type 3R	Single hole mounting Ø22,5mm IP66 <sup>1)</sup> cULus Type 4X	Base mounting w. door coupling IP66 <sup>1)</sup> cULus Type 4X	Modular switch IP40 <sup>1)</sup> cULus Open Type
LS16	16	16	1500	.. E ..	.. Z(O) ..	.. VZV ..	.. SMA ..
LS25	25	25	1500	.. E ..	.. Z(O) ..	.. VZV ..	.. SMA ..
LS32	32	32	1500	.. E ..	.. Z(O) ..	.. VZV ..	.. SMA ..
LS38	38	38	1500	.. E ..	.. Z(O) ..	.. VZV ..	.. SMA ..
LS40	40	40	1500	.. E ..	-	.. VZV ..	.. SMA ..
LS55	55	55	1500	.. E ..	-	.. VZV ..	.. SMA ..
LS65	65	65	1500	.. E ..	-	.. VZV ..	.. SMA ..

### Switch Disconnectors for Photovoltaic

Switch disconnectors „LS..“ are switch gears for interrupting the DC/AC-Inverter from the solar-panels. Photovoltaic-installations have to be equipped with DC-isolators according to IEC 60364-7-712.

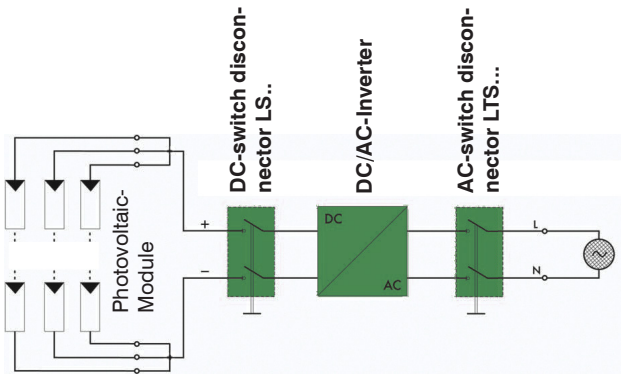

Switch disconnectors „LS..“ ensures a reliable switching up to 85A with 1500V in the category DC21B (DC-PV1).

The construction of the contacts and the material selection guarantee that no oxidation (small switching frequency) develops, and is thus prevented inadmissible heating-up.

The switch disconnector has 2, 4, 6 or 8 contacts, by serial or parallel wiring of the contacts the contact rating will be increased. The switching speed at the manually operated handle does not have an effect on the switching attitude of the contacts.

#### Mounting positions:

No limitations, all kind of positions allowed.

### Ordering

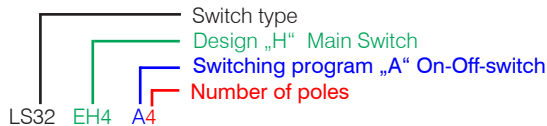

### Switching programs

Type	2-pole	2+2-pole 2 poles in series +2 poles parallel	4-pole	4-pole with jumpers Input on top Output bottom	4-pole with jumpers Input and Output bottom	4-pole with jumpers Input and Output on top
LS16 ... LS55	.. A2	.. A2+2	.. A4(2 x A2)	.. A4B	.. A4O	.. A4U
Contacts Wiring diagram						
Switching example						

1) Protection in front and built in.

## DC-Main Switches

Panel mounting  
Four-hole mounting  
IP66<sup>1)</sup> cULus Type 3R



Single hole mounting  
Ø22,5mm IP66<sup>1)</sup>  
cULus Type 4X



Base mounting  
with door coupling  
IP66<sup>1)</sup> cULus Type 4X



Modular  
switch IP40<sup>1)</sup>  
cULus Open Type



Plastic enclosed  
PFL..IP66/67 cULus Type 4X



.. EH4. ..	.. Z(O)H1 ..	.. VZVH4 ..	.. SMAH1 ..	.. PFLH4 ..
.. EH4. ..	.. Z(O)H1 ..	.. VZVH4 ..	.. SMAH1 ..	.. PFLH4 ..
.. EH4. ..	.. Z(O)H1 ..	.. VZVH4 ..	.. SMAH1 ..	.. PFLH4 ..
.. EH4. ..	.. Z(O)H1 ..	.. VZVH4 ..	.. SMAH1 ..	.. PFLH4 ..
.. EH4. ..	-	.. VZVH4 ..	.. SMAH1 ..	.. PFLH4 ..
.. EH4. ..	-	.. VZVH4 ..	.. SMAH1 ..	.. PFLH4 ..
.. EH4. ..	-	.. VZVH4 ..	.. SMAH1 ..	.. PFLH4 ..

### Technical Data for DC, according to IEC 60947-3, VDE0660, more data find on page 315.

Type		DC-PV1 (=DC21B)							
		500V	600V	700V	800V	900V	1000V	1200V	1500V
2 Poles in series 	<b>LS16..</b> A	16	16	16	16	16	10	7	3
	<b>LS25..</b> A	25	25	25	20	17	11,5	8,5	5
	<b>LS32..</b> A	32	32	32	23	20	13	10	6
	<b>LS38..</b> A	45	45	-	30	-	20	-	-
	<b>LS40..</b> A	48	48	37	35	31	29	11	7,5
	<b>LS55..</b> A	55	55	55	55	43	36	17	10
	<b>LS65..</b> A	75	75	75	65	55	40	17	10
2 Poles in series+2 parallel 	<b>LS16..</b> A	29	29	22	17	16	10	7	3
	<b>LS25..</b> A	45	36	27	19	17	11,5	8,5	5
	<b>LS32..</b> A	58	55	32	23	20	13	10	6
	<b>LS38..</b> A	-	-	-	30	-	20	-	-
	<b>LS40..</b> A	72	68	49	42	31	29	11	7,5
	<b>LS55..</b> A	85	85	77	63	43	36	17	10
	<b>LS65..</b> A	85	85	80	65	55	40	17	10
4 Poles in series 	<b>LS16..</b> A	16	16	16	16	16	16	16	16
	<b>LS25..</b> A	25	25	25	25	25	25	25	25
	<b>LS32..</b> A	32	32	32	32	32	32	32	32
	<b>LS38..</b> A	45	45	45	45	45	38	32	32
	<b>LS40..</b> A	48	48	40	40	40	40	40	40
	<b>LS55..</b> A	55	55	55	55	55	55	55	55
	<b>LS65..</b> A	75	75	75	75	75	75	65	65
4 Poles in series+2 parallel 	<b>LS16..</b> A	29	29	29	29	29	29	29	20
	<b>LS25..</b> A	45	45	45	45	45	45	45	26
	<b>LS32..</b> A	58	58	58	58	58	58	50	32
	<b>LS38..</b> A	-	-	-	-	-	-	-	-
	<b>LS40..</b> A	72	72	72	72	72	72	56	42
	<b>LS55..</b> A	85	85	85	85	85	85	65	55
	<b>LS65..</b> A	85	85	85	85	85	85	65	55

**Type**                      6-pole                      3+2-pole  
3 poles in series  
+2 poles parallel                      8-pole                      4+2-pole  
4 poles in series  
+2 poles parallel

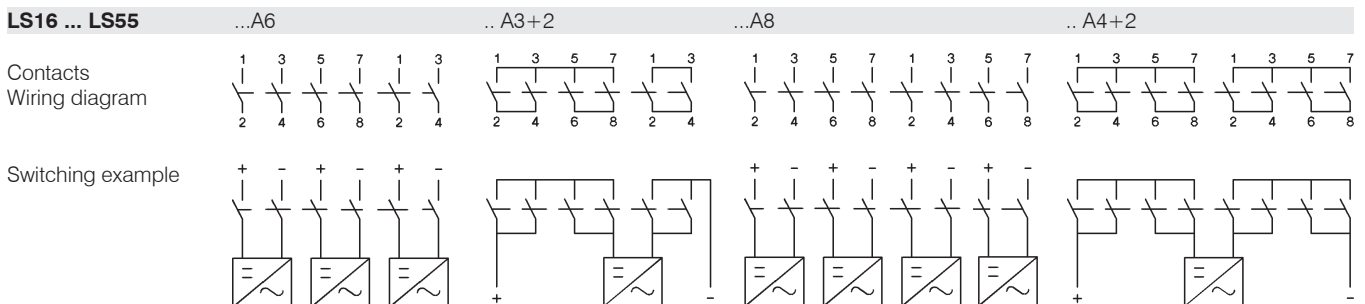

**Insulated jumpers LSV..** for series and parallel switching of contacts see page 325.



# ON-OFF Switches for Panel Mounting, Escutcheon plate 64<sup>o</sup>, IP66, US Type 3R



DC21B / DC-PV1 600V DC	DC 1000V DC	Poles in series	Number of strings	Type	Pack pcs.	Weight kg/pcs.
16A	10A	2	1	<b>LS16 E A2</b>	1	0,20
25A	11,5A	2	1	<b>LS25 E A2</b>	1	0,20
32A	13A	2	1	<b>LS32 E A2</b>	1	0,20
45A	20A	2	1	<b>LS38 E A2</b>	1	0,20
48A	29A	2	1	<b>LS40 E A2</b>	1	0,41
55A	36A	2	1	<b>LS55 E A2</b>	1	0,41
65A	40A	2	1	<b>LS65 E A2</b>	1	0,41

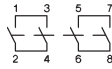

29A	10A	2	1	<b>LS16 E A2+2</b>	1	0,25
36A	11,5A	2	1	<b>LS25 E A2+2</b>	1	0,25
55A	13A	2	1	<b>LS32 E A2+2</b>	1	0,25
-	20A	2	1	<b>LS38 E A2+2</b>	1	0,25
68A	29A	2	1	<b>LS40 E A2+2</b>	1	0,54
85A	36A	2	1	<b>LS55 E A2+2</b>	1	0,54
85A	40A	2	1	<b>LS65 E A2+2</b>	1	0,54

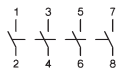

16A	10A	2	2	<b>LS16 E A4</b>	1	0,23
25A	11,5A	2	2	<b>LS25 E A4</b>	1	0,23
32A	13A	2	2	<b>LS32 E A4</b>	1	0,23
45A	20A	2	2	<b>LS38 E A4</b>	1	0,23
48A	29A	2	2	<b>LS40 E A4</b>	1	0,49
55A	36A	2	2	<b>LS55 E A4</b>	1	0,49
65A	40A	2	2	<b>LS65 E A4</b>	1	0,49

Type suffix



**B** ..A4B

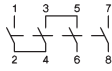

16A	16A	4	1	<b>LS16 E A4.</b>	1	0,24
25A	25A	4	1	<b>LS25 E A4.</b>	1	0,24
32A	32A	4	1	<b>LS32 E A4.</b>	1	0,24
45A	-	4	1	<b>LS38 E A4.</b>	1	0,24
48A	40A	4	1	<b>LS40 E A4.</b>	1	0,52
55A	55A	4	1	<b>LS55 E A4.</b>	1	0,52
-	-	4	1	<b>LS65 E A4.</b>	1	0,52

**O** ..A4O

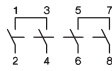

16A	16A	4	1	<b>LS16 E A4.</b>	1	0,24
25A	25A	4	1	<b>LS25 E A4.</b>	1	0,24
32A	32A	4	1	<b>LS32 E A4.</b>	1	0,24
45A	-	4	1	<b>LS38 E A4.</b>	1	0,24
48A	40A	4	1	<b>LS40 E A4.</b>	1	0,52
55A	55A	4	1	<b>LS55 E A4.</b>	1	0,52
-	-	4	1	<b>LS65 E A4.</b>	1	0,52

**U** ..A4U

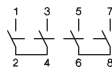

16A	16A	4	1	<b>LS16 E A4.</b>	1	0,24
25A	25A	4	1	<b>LS25 E A4.</b>	1	0,24
32A	32A	4	1	<b>LS32 E A4.</b>	1	0,24
45A	-	4	1	<b>LS38 E A4.</b>	1	0,24
48A	40A	4	1	<b>LS40 E A4.</b>	1	0,52
55A	55A	4	1	<b>LS55 E A4.</b>	1	0,52
-	-	4	1	<b>LS65 E A4.</b>	1	0,52

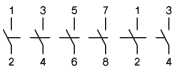

16A	10A	2	3	<b>LS16 E A6</b>	1	0,36
25A	11,5A	2	3	<b>LS25 E A6</b>	1	0,36
32A	13A	2	3	<b>LS32 E A6</b>	1	0,36
45A	20A	2	3	<b>LS38 E A6</b>	1	0,36
48A	29A	2	3	<b>LS40 E A6</b>	1	0,99
55A	36A	2	3	<b>LS55 E A6</b>	1	0,99
-	-	2	3	<b>LS65 E A6</b>	1	0,99

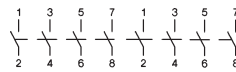

16A	10A	2	4	<b>LS16 E A8</b>	1	0,41
25A	11,5A	2	4	<b>LS25 E A8</b>	1	0,41
32A	13A	2	4	<b>LS32 E A8</b>	1	0,41
45A	20A	2	4	<b>LS38 E A8</b>	1	0,41
48A	29A	2	4	<b>LS40 E A8</b>	1	1,09
55A	36A	2	4	<b>LS55 E A8</b>	1	1,09
-	-	2	4	<b>LS65 E A8</b>	1	1,09

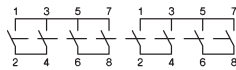

29A	29A	4	1	<b>LS16 E A4+2</b>	1	0,46
45A	45A	4	1	<b>LS25 E A4+2</b>	1	0,46
58A	58A	4	1	<b>LS32 E A4+2</b>	1	0,46
-	-	4	1	<b>LS38 E A4+2</b>	1	0,46
72A	72A	4	1	<b>LS40 E A4+2</b>	1	1,20
85A	85A	4	1	<b>LS55 E A4+2</b>	1	1,20
85A	85A	4	1	<b>LS65 E A4+2</b>	1	1,20



## Extended Switch Shaft for all switches for Panel Mounting

Type suffix

+VW"x"

x = panel thickness

## ON-OFF Switches for Single Hole Mounting Ø22mm, Escutcheon plate 48<sup>□</sup>, IP66, c(UL)us Type 4X

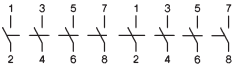
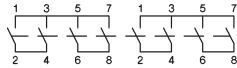
	DC21B / DC-PV1		Anzahl Pole in Serie	Anzahl Strings	Typ	VPE Stk.	Gewicht kg/Stk.	
	600V DC	1000V DC						
								
								
Typenzusatz ↓								
								
								
								

## ON-OFF Switches for Single Hole Mounting Ø22mm, without Escutcheon plate, IP66, c(UL)us Type 4X



Replace the Type „Z“ with „ZO“ **LS.. ZO A.**

# ON-OFF Switches f. Base Mounting w. Door Clutch f. Single Hole, Plate 64<sup>□</sup>, IP66, cUL<sup>us</sup> Type 4X



DC21B / DC-PV1 600V DC	DC 1000V DC	Poles in series	Number of strings	Type	Pack pcs.	Weight kg/pcs.
16A	10A	2	1	<b>LS16 VZV A2</b>	1	0,22
25A	11,5A	2	1	<b>LS25 VZV A2</b>	1	0,22
32A	13A	2	1	<b>LS32 VZV A2</b>	1	0,22
45A	20A	2	1	<b>LS38 VZV A2</b>	1	0,22
48A	29A	2	1	<b>LS40 VZV A2</b>	1	0,51
55A	36A	2	1	<b>LS55 VZV A2</b>	1	0,51
65A	40A	2	1	<b>LS65 VZV A2</b>	1	0,51

Depth is adjustable

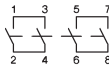

29A	10A	2	1	<b>LS16 VZV A2+2</b>	1	0,27
36A	11,5A	2	1	<b>LS25 VZV A2+2</b>	1	0,27
55A	13A	2	1	<b>LS32 VZV A2+2</b>	1	0,27
-	20A	2	1	<b>LS38 VZV A2+2</b>	1	0,27
68A	29A	2	1	<b>LS40 VZV A2+2</b>	1	0,55
85A	36A	2	1	<b>LS55 VZV A2+2</b>	1	0,55
85A	40A	2	1	<b>LS65 VZV A2+2</b>	1	0,55

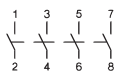

16A	10A	2	2	<b>LS16 VZV A4</b>	1	0,25
25A	11,5A	2	2	<b>LS25 VZV A4</b>	1	0,25
32A	13A	2	2	<b>LS32 VZV A4</b>	1	0,25
45A	20A	2	2	<b>LS38 VZV A4</b>	1	0,25
48A	29A	2	2	<b>LS40 VZV A4</b>	1	0,56
55A	36A	2	2	<b>LS55 VZV A4</b>	1	0,56
65A	40A	2	2	<b>LS65 VZV A4</b>	1	0,56

Type suffix



**B ..A4B**

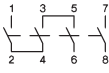

16A	16A	4	1	<b>LS16 VZV A4.</b>	1	0,26
25A	25A	4	1	<b>LS25 VZV A4.</b>	1	0,26
32A	32A	4	1	<b>LS32 VZV A4.</b>	1	0,26
45A	-	4	1	<b>LS38 VZV A4.</b>	1	0,26
48A	40A	4	1	<b>LS40 VZV A4.</b>	1	0,58
55A	55A	4	1	<b>LS55 VZV A4.</b>	1	0,58
-	-	4	1	<b>LS65 VZV A4.</b>	1	0,58

**O ..A4O**

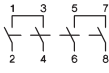

**U ..A4U**

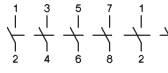
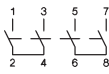

16A	10A	2	3	<b>LS16 VZV A6</b>	1	0,38
25A	11,5A	2	3	<b>LS25 VZV A6</b>	1	0,38
32A	13A	2	3	<b>LS32 VZV A6</b>	1	0,38
45A	20A	2	3	<b>LS38 VZV A6</b>	1	0,38
48A	29A	2	3	<b>LS40 VZV A6</b>	1	1,00
55A	36A	2	3	<b>LS55 VZV A6</b>	1	1,00
-	-	2	3	<b>LS65 VZV A6</b>	1	1,00

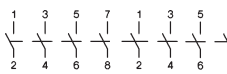

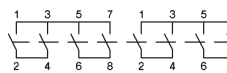

16A	10A	2	4	<b>LS16 VZV A8</b>	1	0,43
25A	11,5A	2	4	<b>LS25 VZV A8</b>	1	0,43
32A	13A	2	4	<b>LS32 VZV A8</b>	1	0,43
45A	20A	2	4	<b>LS38 VZV A8</b>	1	0,43
48A	29A	2	4	<b>LS40 VZV A8</b>	1	1,10
55A	36A	2	4	<b>LS55 VZV A8</b>	1	1,10
-	-	2	4	<b>LS65 VZV A8</b>	1	1,10



29A	29A	4	1	<b>LS16 VZV A4+2</b>	1	0,48
45A	45A	4	1	<b>LS25 VZV A4+2</b>	1	0,48
58A	58A	4	1	<b>LS32 VZV A4+2</b>	1	0,48
-	-	4	1	<b>LS38 VZV A4+2</b>	1	0,48
72A	72A	4	1	<b>LS40 VZV A4+2</b>	1	1,21
85A	85A	4	1	<b>LS55 VZV A4+2</b>	1	1,21
85A	85A	4	1	<b>LS65 VZV A4+2</b>	1	1,21

# ON-OFF Switches for Distribution Boards, IP40, US Open Type

	DC21B / DC-PV1		Poles in series	Number of strings	Type	Pack pcs.	Weight kg/pcs.
	600V DC	1000V DC					
							
	16A	10A	2	1	<b>LS16 SMA A2</b>	1	0,19
	25A	11,5A	2	1	<b>LS25 SMA A2</b>	1	0,19
	32A	13A	2	1	<b>LS32 SMA A2</b>	1	0,19
	45A	20A	2	1	<b>LS38 SMA A2</b>	1	0,19
	48A	29A	2	1	<b>LS40 SMA A2</b>	1	0,41
	55A	36A	2	1	<b>LS55 SMA A2</b>	1	0,41
	65A	40A	2	1	<b>LS65 SMA A2</b>	1	0,41
							
	29A	10A	2	1	<b>LS16 SMA A2+2</b>	1	0,24
	36A	11,5A	2	1	<b>LS25 SMA A2+2</b>	1	0,24
	55A	13A	2	1	<b>LS32 SMA A2+2</b>	1	0,24
	-	20A	2	1	<b>LS38 SMA A2+2</b>	1	0,24
	68A	29A	2	1	<b>LS40 SMA A2+2</b>	1	0,52
	85A	36A	2	1	<b>LS55 SMA A2+2</b>	1	0,52
	85A	40A	2	1	<b>LS65 SMA A2+2</b>	1	0,52
	16A	10A	2	2	<b>LS16 SMA A4</b>	1	0,22
	25A	11,5A	2	2	<b>LS25 SMA A4</b>	1	0,22
	32A	13A	2	2	<b>LS32 SMA A4</b>	1	0,22
	45A	20A	2	2	<b>LS38 SMA A4</b>	1	0,22
	48A	29A	2	2	<b>LS40 SMA A4</b>	1	0,45
	55A	36A	2	2	<b>LS55 SMA A4</b>	1	0,45
	65A	40A	2	2	<b>LS65 SMA A4</b>	1	0,45
Type suffix							
<b>B ..A4B</b>							
<b>O ..A4O</b>							
<b>U ..A4U</b>							
	16A	16A	4	1	<b>LS16 SMA A4.</b>	1	0,23
	25A	25A	4	1	<b>LS25 SMA A4.</b>	1	0,23
	32A	32A	4	1	<b>LS32 SMA A4.</b>	1	0,23
	45A	-	4	1	<b>LS32 SMA A4.</b>	1	0,23
	48A	40A	4	1	<b>LS40 SMA A4.</b>	1	0,49
	55A	55A	4	1	<b>LS55 SMA A4.</b>	1	0,49
	-	-	4	1	<b>LS65 SMA A4.</b>	1	0,49
							
	16A	10A	2	3	<b>LS16 SMA A6</b>	1	0,35
	25A	11,5A	2	3	<b>LS25 SMA A6</b>	1	0,35
	32A	13A	2	3	<b>LS32 SMA A6</b>	1	0,35
	45A	20A	2	3	<b>LS38 SMA A6</b>	1	0,35
	48A	29A	2	3	<b>LS40 SMA A6</b>	1	0,89
	55A	36A	2	3	<b>LS55 SMA A6</b>	1	0,89
	-	-	2	3	<b>LS65 SMA A6</b>	1	0,89
	16A	10A	2	4	<b>LS16 SMA A8</b>	1	0,40
	25A	11,5A	2	4	<b>LS25 SMA A8</b>	1	0,40
	32A	13A	2	4	<b>LS32 SMA A8</b>	1	0,40
	45A	20A	2	4	<b>LS38 SMA A8</b>	1	0,40
	48A	29A	2	4	<b>LS40 SMA A8</b>	1	0,99
	55A	36A	2	4	<b>LS55 SMA A8</b>	1	0,99
	-	-	2	4	<b>LS65 SMA A8</b>	1	0,99
	29A	29A	4	1	<b>LS16 SMA A4+2</b>	1	0,43
	45A	45A	4	1	<b>LS25 SMA A4+2</b>	1	0,43
	58A	58A	4	1	<b>LS32 SMA A4+2</b>	1	0,43
	-	-	4	1	<b>LS38 SMA A4+2</b>	1	0,43
	72A	72A	4	1	<b>LS40 SMA A4+2</b>	1	1,01
	85A	85A	4	1	<b>LS55 SMA A4+2</b>	1	1,01
	85A	85A	4	1	<b>LS65 SMA A4+2</b>	1	1,01

# Main Switches for Panel Mounting, Escutcheon plate 64<sup>2</sup>, IP66, Type 3R



padlock device SV4



DC21B / DC-PV1 600V DC 1000V DC		Poles in series	Number of strings	Type	Pack pcs.	Weight kg/pcs.
16A	10A	2	1	<b>LS16 EH4 A2</b>	1	0,21
25A	11,5A	2	1	<b>LS25 EH4 A2</b>	1	0,21
32A	13A	2	1	<b>LS32 EH4 A2</b>	1	0,21
45A	20A	2	1	<b>LS38 EH4 A2</b>	1	0,21
48A	29A	2	1	<b>LS40 EH4 A2</b>	1	0,43
55A	36A	2	1	<b>LS55 EH4 A2</b>	1	0,43
65A	40A	2	1	<b>LS65 EH4 A2</b>	1	0,43

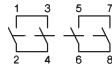

29A	10A	2	1	<b>LS16 EH4 A2+2</b>	1	0,26
36A	11,5A	2	1	<b>LS25 EH4 A2+2</b>	1	0,26
55A	13A	2	1	<b>LS32 EH4 A2+2</b>	1	0,26
-	20A	2	1	<b>LS38 EH4 A2+2</b>	1	0,26
68A	29A	2	1	<b>LS40 EH4 A2+2</b>	1	0,57
85A	36A	2	1	<b>LS55 EH4 A2+2</b>	1	0,57
85A	40A	2	1	<b>LS65 EH4 A2+2</b>	1	0,57

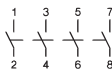

16A	10A	2	2	<b>LS16 EH4 A4</b>	1	0,24
25A	11,5A	2	2	<b>LS25 EH4 A4</b>	1	0,24
32A	13A	2	2	<b>LS32 EH4 A4</b>	1	0,24
45A	20A	2	2	<b>LS38 EH4 A4</b>	1	0,24
48A	29A	2	2	<b>LS40 EH4 A4</b>	1	0,50
55A	36A	2	2	<b>LS55 EH4 A4</b>	1	0,50
65A	40A	2	2	<b>LS65 EH4 A4</b>	1	0,50

Type suffix



**B ..A4B**

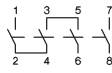

16A	16A	4	1	<b>LS16 EH4 A4.</b>	1	0,25
25A	25A	4	1	<b>LS25 EH4 A4.</b>	1	0,25
32A	32A	4	1	<b>LS32 EH4 A4.</b>	1	0,25
45A	-	4	1	<b>LS38 EH4 A4.</b>	1	0,25
48A	40A	4	1	<b>LS40 EH4 A4.</b>	1	0,53
55A	55A	4	1	<b>LS55 EH4 A4.</b>	1	0,53
-	-	4	1	<b>LS65 EH4 A4.</b>	1	0,53

**O ..A4O**

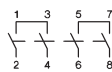

**U ..A4U**

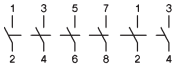

16A	10A	2	3	<b>LS16 EH4 A6</b>	1	0,37
25A	11,5A	2	3	<b>LS25 EH4 A6</b>	1	0,37
32A	13A	2	3	<b>LS32 EH4 A6</b>	1	0,37
45A	20A	2	3	<b>LS38 EH4 A6</b>	1	0,37
48A	29A	2	3	<b>LS40 EH4 A6</b>	1	0,53
55A	36A	2	3	<b>LS55 EH4 A6</b>	1	0,53
-	-	2	3	<b>LS65 EH4 A6</b>	1	0,53

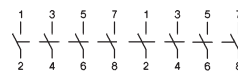

16A	10A	2	4	<b>LS16 EH4 A8</b>	1	0,42
25A	11,5A	2	4	<b>LS25 EH4 A8</b>	1	0,42
32A	13A	2	4	<b>LS32 EH4 A8</b>	1	0,42
45A	20A	2	4	<b>LS38 EH4 A8</b>	1	0,42
48A	29A	2	4	<b>LS40 EH4 A8</b>	1	1,10
55A	36A	2	4	<b>LS55 EH4 A8</b>	1	1,10
-	-	2	4	<b>LS65 EH4 A8</b>	1	1,10

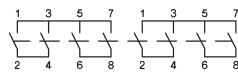

29A	29A	4	1	<b>LS16 EH4 A4+2</b>	1	0,47
45A	45A	4	1	<b>LS25 EH4 A4+2</b>	1	0,47
58A	58A	4	1	<b>LS32 EH4 A4+2</b>	1	0,47
-	-	4	1	<b>LS38 EH4 A4+2</b>	1	0,47
72A	72A	4	1	<b>LS40 EH4 A4+2</b>	1	1,21
85A	85A	4	1	<b>LS55 EH4 A4+2</b>	1	1,21
85A	85A	4	1	<b>LS65 EH4 A4+2</b>	1	1,21



## Extended Switch Shaft for all switches for panel mounting

Type suffix

+VW"x"

x = panel thickness

# Main Switches for Single Hole Mounting Ø22mm, Escutcheon plate 48<sup>o</sup>, IP66, Type 4X

	DC21B / DC-PV1		Poles in series	Number of strings	Type	Pack pcs.	Weight kg/pcs.
	600V DC	1000V DC					
			2	1	<b>LS16 ZH1 A2</b>	1	0,21
			2	1	<b>LS25 ZH1 A2</b>	1	0,21
			2	1	<b>LS32 ZH1 A2</b>	1	0,21
			2	1	<b>LS38 ZH1 A2</b>	1	0,21
			2	1			
Sperrvorrichtung SV1			2	1	<b>LS16 ZH1 A2+2</b>	1	0,27
			2	1	<b>LS25 ZH1 A2+2</b>	1	0,27
			2	1	<b>LS32 ZH1 A2+2</b>	1	0,27
			2	1	<b>LS38 ZH1 A2+2</b>	1	0,27
			2	2	<b>LS16 ZH1 A4</b>	1	0,24
			2	2	<b>LS25 ZH1 A4</b>	1	0,24
			2	2	<b>LS32 ZH1 A4</b>	1	0,24
			2	2	<b>LS38 ZH1 A4</b>	1	0,24
			2	2			
Typenzusatz ↓ <b>B ..A4B</b> <b>O ..A4O</b> <b>U ..A4U</b>			4	1	<b>LS16 ZH1 A4.</b>	1	0,25
			4	1	<b>LS25 ZH1 A4.</b>	1	0,25
			4	1	<b>LS32 ZH1 A4.</b>	1	0,25
			4	1	<b>LS38 ZH1 A4.</b>	1	0,25
			2	3	<b>LS16 ZH1 A6</b>	1	0,39
			2	3	<b>LS25 ZH1 A6</b>	1	0,39
			2	3	<b>LS32 ZH1 A6</b>	1	0,39
			2	3	<b>LS38 ZH1 A6</b>	1	0,39
			2	4	<b>LS16 ZH1 A8</b>	1	0,44
			2	4	<b>LS25 ZH1 A8</b>	1	0,44
			2	4	<b>LS32 ZH1 A8</b>	1	0,44
			2	4	<b>LS38 ZH1 A8</b>	1	0,44
			4	1	<b>LS16 ZH1 A4+2</b>	1	0,49
			4	1	<b>LS25 ZH1 A4+2</b>	1	0,49
			4	1	<b>LS32 ZH1 A4+2</b>	1	0,49
			4	1	<b>LS38 ZH1 A4+2</b>	1	0,49

# Main Switches, Single Hole Mounting Ø22mm, without Escutcheon plate, IP66, Type 4X

Replace the Type „ZH1“ with „ZOH1“ **LS.. ZOH1 A.**

# Main Switches f. Base Mounting, Door Clutch f. Single Hole, Plate 64<sup>□</sup>, IP66, Type 4X



DC21B / DC-PV1 600V DC	DC 1000V DC	Poles in series	Number of strings	Type	Pack pcs.	Weight kg/pcs.
16A	10A	2	1	<b>LS16 VZVH4 A2</b>	1	0,23
25A	11,5A	2	1	<b>LS25 VZVH4 A2</b>	1	0,23
32A	13A	2	1	<b>LS32 VZVH4 A2</b>	1	0,23
45A	20A	2	1	<b>LS38 VZVH4 A2</b>	1	0,23
48A	29A	2	1	<b>LS40 VZVH4 A2</b>	1	0,51
55A	36A	2	1	<b>LS55 VZVH4 A2</b>	1	0,51
65A	40A	2	1	<b>LS65 VZVH4 A2</b>	1	0,51

Depth is adjustable  
see page 322  
padlock device SV4

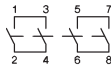

29A	10A	2	1	<b>LS16 VZVH4 A2+2</b>	1	0,28
36A	11,5A	2	1	<b>LS25 VZVH4 A2+2</b>	1	0,28
55A	13A	2	1	<b>LS32 VZVH4 A2+2</b>	1	0,28
-	20A	2	1	<b>LS38 VZVH4 A2+2</b>	1	0,28
68A	29A	2	1	<b>LS40 VZVH4 A2+2</b>	1	0,65
85A	36A	2	1	<b>LS55 VZVH4 A2+2</b>	1	0,65
85A	40A	2	1	<b>LS65 VZVH4 A2+2</b>	1	0,65

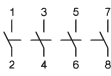

16A	10A	2	2	<b>LS16 VZVH4 A4</b>	1	0,26
25A	11,5A	2	2	<b>LS25 VZVH4 A4</b>	1	0,26
32A	13A	2	2	<b>LS32 VZVH4 A4</b>	1	0,26
45A	20A	2	2	<b>LS38 VZVH4 A4</b>	1	0,26
48A	29A	2	2	<b>LS40 VZVH4 A4</b>	1	0,58
55A	36A	2	2	<b>LS55 VZVH4 A4</b>	1	0,58
65A	40A	2	2	<b>LS65 VZVH4 A4</b>	1	0,58

Type suffix



**B ..A4B**

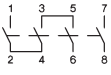

16A	16A	4	1	<b>LS16 VZVH4 A4.</b>	1	0,27
25A	25A	4	1	<b>LS25 VZVH4 A4.</b>	1	0,27
32A	32A	4	1	<b>LS32 VZVH4 A4.</b>	1	0,27
45A	-	4	1	<b>LS38 VZVH4 A4.</b>	1	0,27
48A	40A	4	1	<b>LS40 VZVH4 A4.</b>	1	0,62
55A	55A	4	1	<b>LS55 VZVH4 A4.</b>	1	0,62
-	-	4	1	<b>LS65 VZVH4 A4.</b>	1	0,62

**O ..A4O**

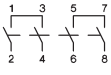

**U ..A4U**

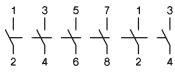
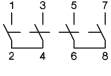

16A	10A	2	3	<b>LS16 VZVH4 A6</b>	1	0,39
25A	11,5A	2	3	<b>LS25 VZVH4 A6</b>	1	0,39
32A	13A	2	3	<b>LS32 VZVH4 A6</b>	1	0,39
45A	20A	2	3	<b>LS38 VZVH4 A6</b>	1	0,39
48A	29A	2	3	<b>LS40 VZVH4 A6</b>	1	1,00
55A	36A	2	3	<b>LS55 VZVH4 A6</b>	1	1,00
-	-	2	3	<b>LS65 VZVH4 A6</b>	1	1,00

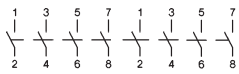

16A	10A	2	4	<b>LS16 VZVH4 A8</b>	1	0,44
25A	11,5A	2	4	<b>LS25 VZVH4 A8</b>	1	0,44
32A	13A	2	4	<b>LS32 VZVH4 A8</b>	1	0,44
45A	20A	2	4	<b>LS38 VZVH4 A8</b>	1	0,44
48A	29A	2	4	<b>LS40 VZVH4 A8</b>	1	1,11
55A	36A	2	4	<b>LS55 VZVH4 A8</b>	1	1,11
-	-	2	4	<b>LS65 VZVH4 A8</b>	1	1,11

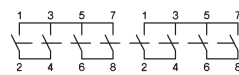

29A	29A	4	1	<b>LS16 VZVH4 A4+2</b>	1	0,49
45A	45A	4	1	<b>LS25 VZVH4 A4+2</b>	1	0,49
58A	58A	4	1	<b>LS32 VZVH4 A4+2</b>	1	0,49
-	-	4	1	<b>LS38 VZVH4 A4+2</b>	1	0,49
72A	72A	4	1	<b>LS40 VZVH4 A4+2</b>	1	1,22
85A	85A	4	1	<b>LS55 VZVH4 A4+2</b>	1	1,22
85A	85A	4	1	<b>LS65 VZVH4 A4+2</b>	1	1,22

# Main Switches for Distribution Boards, lockable, IP40, Open Type



Padlock device SV1



DC21B / DC-PV1 600V DC 1000V DC		Poles in series	Number of strings	Type	Pack pcs.	Weight kg/pcs.
16A	10A	2	1	<b>LS16 SMAH1 A2</b>	1	0,19
25A	11,5A	2	1	<b>LS25 SMAH1 A2</b>	1	0,19
32A	13A	2	1	<b>LS32 SMAH1 A2</b>	1	0,19
45A	20A	2	1	<b>LS38 SMAH1 A2</b>	1	0,19
48A	29A	2	1	<b>LS40 SMAH1 A2</b>	1	0,40
55A	36A	2	1	<b>LS55 SMAH1 A2</b>	1	0,40
65A	40A	2	1	<b>LS65 SMAH1 A2</b>	1	0,40

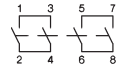

29A	10A	2	1	<b>LS16 SMAH1 A2+2</b> <sup>1)</sup>	1	0,25
36A	11,5A	2	1	<b>LS25 SMAH1 A2+2</b> <sup>1)</sup>	1	0,25
55A	13A	2	1	<b>LS32 SMAH1 A2+2</b> <sup>1)</sup>	1	0,25
-	20A	2	1	<b>LS38 SMAH1 A2+2</b> <sup>1)</sup>	1	0,25
68A	29A	2	1	<b>LS40 SMAH1 A2+2</b>	1	0,54
85A	36A	2	1	<b>LS55 SMAH1 A2+2</b>	1	0,54
85A	40A	2	1	<b>LS65 SMAH1 A2+2</b>	1	0,54

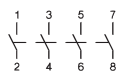

16A	10A	2	2	<b>LS16 SMAH1 A4</b> <sup>1)</sup>	1	0,22
25A	11,5A	2	2	<b>LS25 SMAH1 A4</b> <sup>1)</sup>	1	0,22
32A	13A	2	2	<b>LS32 SMAH1 A4</b> <sup>1)</sup>	1	0,22
45A	20A	2	2	<b>LS38 SMAH1 A4</b> <sup>1)</sup>	1	0,22
48A	29A	2	2	<b>LS40 SMAH1 A4</b>	1	0,47
55A	36A	2	2	<b>LS55 SMAH1 A4</b>	1	0,47
65A	40A	2	2	<b>LS65 SMAH1 A4</b>	1	0,47

Type suffix



**B ..A4B**

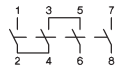

**O ..A4O**

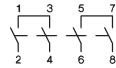

**U ..A4U**

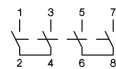

16A	16A	4	1	<b>LS16 SMAH1 A4.</b> <sup>1)</sup>	1	0,23
25A	25A	4	1	<b>LS25 SMAH1 A4.</b> <sup>1)</sup>	1	0,23
32A	32A	4	1	<b>LS32 SMAH1 A4.</b> <sup>1)</sup>	1	0,23
45A	-	4	1	<b>LS38 SMAH1 A4.</b> <sup>1)</sup>	1	0,23
48A	40A	4	1	<b>LS40 SMAH1 A4.</b>	1	0,50
55A	55A	4	1	<b>LS55 SMAH1 A4.</b>	1	0,50
-	-	4	1	<b>LS65 SMAH1 A4.</b>	1	0,50

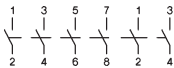

16A	10A	2	3	<b>LS16 SMAH1 A6</b>	1	0,36
25A	11,5A	2	3	<b>LS25 SMAH1 A6</b>	1	0,36
32A	13A	2	3	<b>LS32 SMAH1 A6</b>	1	0,36
45A	20A	2	3	<b>LS38 SMAH1 A6</b>	1	0,36
48A	29A	2	3	<b>LS40 SMAH1 A6</b>	1	0,90
55A	36A	2	3	<b>LS55 SMAH1 A6</b>	1	0,90
-	-	2	3	<b>LS65 SMAH1 A6</b>	1	0,90

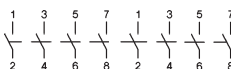

16A	10A	2	4	<b>LS16 SMAH1 A8</b>	1	0,41
25A	11,5A	2	4	<b>LS25 SMAH1 A8</b>	1	0,41
32A	13A	2	4	<b>LS32 SMAH1 A8</b>	1	0,41
45A	20A	2	4	<b>LS38 SMAH1 A8</b>	1	0,41
48A	29A	2	4	<b>LS40 SMAH1 A8</b>	1	0,41
55A	36A	2	4	<b>LS55 SMAH1 A8</b>	1	0,41
-	-	2	4	<b>LS65 SMAH1 A8</b>	1	0,41

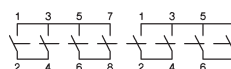

29A	29A	4	1	<b>LS16 SMAH1 A4+2</b>	1	0,46
45A	45A	4	1	<b>LS25 SMAH1 A4+2</b>	1	0,46
58A	58A	4	1	<b>LS32 SMAH1 A4+2</b>	1	0,46
-	-	4	1	<b>LS38 SMAH1 A4+2</b>	1	0,46
72A	72A	4	1	<b>LS40 SMAH1 A4+2</b>	1	1,12
85A	85A	4	1	<b>LS55 SMAH1 A4+2</b>	1	1,12
85A	85A	4	1	<b>LS65 SMAH1 A4+2</b>	1	1,12

## 1) Main Switches for Distribution Boards with low height handle, IP40, Open Type

With type suffix „+SV1N“, e.g.: **LS.. SMAH1 A2+2 +SV1N**

# Main Switches in Plastic Enclosure, Escutcheon plate 64<sup>0</sup>, IP66/67, Type 4X



DC21B / DC-PV1 600V DC	DC 1000V DC	Poles in series	Number of strings	Type	Pack pcs.	Weight kg/pcs.
16A	10A	2	1	<b>LS16 PFLH4 A2</b>	1	0,43
25A	11,5A	2	1	<b>LS25 PFLH4 A2</b>	1	0,43
32A	13A	2	1	<b>LS32 PFLH4 A2</b>	1	0,43
45A	20A	2	1	<b>LS38 PFLH4 A2</b>	1	0,43
48A	29A	2	1	<b>LS40 PFLH4 A2</b> <sup>1)</sup>	1	1,59
55A	36A	2	1	<b>LS55 PFLH4 A2</b> <sup>1)</sup>	1	1,59
65A	40A	2	1	<b>LS65 PFLH4 A2</b> <sup>1)</sup>	1	1,59

Padlock device SV4

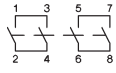

29A	10A	2	1	<b>LS16 PFLH4 A2+2</b>	1	0,49
36A	11,5A	2	1	<b>LS25 PFLH4 A2+2</b>	1	0,49
55A	13A	2	1	<b>LS32 PFLH4 A2+2</b>	1	0,49
-	20A	2	1	<b>LS38 PFLH4 A2+2</b>	1	0,49
68A	29A	2	1	<b>LS40 PFLH4 A2+2</b> <sup>1)</sup>	1	1,74
85A	36A	2	1	<b>LS55 PFLH4 A2+2</b> <sup>1)</sup>	1	1,74
85A	40A	2	1	<b>LS65 PFLH4 A2+2</b> <sup>1)</sup>	1	1,74

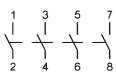

16A	10A	2	2	<b>LS16 PFLH4 A4</b>	1	0,46
25A	11,5A	2	2	<b>LS25 PFLH4 A4</b>	1	0,46
32A	13A	2	2	<b>LS32 PFLH4 A4</b>	1	0,46
45A	20A	2	2	<b>LS38 PFLH4 A4</b>	1	0,46
48A	29A	2	2	<b>LS40 PFLH4 A4</b> <sup>1)</sup>	1	1,67
55A	36A	2	2	<b>LS55 PFLH4 A4</b> <sup>1)</sup>	1	1,67
65A	40A	2	2	<b>LS65 PFLH4 A4</b> <sup>1)</sup>	1	1,67

Type suffix



**B ..A4B**

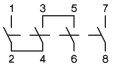

16A	16A	4	1	<b>LS16 PFLH4 A4.</b>	1	0,47
25A	25A	4	1	<b>LS25 PFLH4 A4.</b>	1	0,47
32A	32A	4	1	<b>LS32 PFLH4 A4.</b>	1	0,47
45A	-	4	1	<b>LS38 PFLH4 A4.</b>	1	0,47
48A	40A	4	1	<b>LS40 PFLH4 A4.</b> <sup>1)</sup>	1	1,70
55A	55A	4	1	<b>LS55 PFLH4 A4.</b> <sup>1)</sup>	1	1,70
-	-	4	1	<b>LS65 PFLH4 A4.</b> <sup>1)</sup>	1	1,70

**O ..A4O**

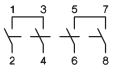

**U ..A4U**

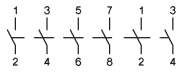
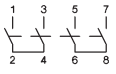

16A	10A	2	3	<b>LS16 PFLH4 A6</b>	1	1,53
25A	11,5A	2	3	<b>LS25 PFLH4 A6</b>	1	1,53
32A	13A	2	3	<b>LS32 PFLH4 A6</b>	1	1,53
45A	20A	2	3	<b>LS38 PFLH4 A6</b>	1	1,53
48A	29A	2	3	<b>LS40 PFLH4 A6</b>	1	1,87
55A	36A	2	3	<b>LS55 PFLH4 A6</b>	1	1,87
-	-	2	3	<b>LS65 PFLH4 A6</b>	1	1,87

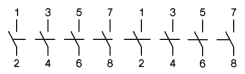

16A	10A	2	4	<b>LS16 PFLH4 A8</b>	1	1,58
25A	11,5A	2	4	<b>LS25 PFLH4 A8</b>	1	1,58
32A	13A	2	4	<b>LS32 PFLH4 A8</b>	1	1,58
45A	20A	2	4	<b>LS38 PFLH4 A8</b>	1	1,58
48A	29A	2	4	<b>LS40 PFLH4 A8</b>	1	1,94
55A	36A	2	4	<b>LS55 PFLH4 A8</b>	1	1,94
-	-	2	4	<b>LS65 PFLH4 A8</b>	1	1,94

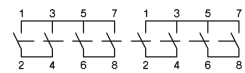

29A	29A	4	1	<b>LS16 PFLH4 A4+2</b>	1	1,63
45A	45A	4	1	<b>LS25 PFLH4 A4+2</b>	1	1,63
58A	58A	4	1	<b>LS32 PFLH4 A4+2</b>	1	1,63
-	-	4	1	<b>LS38 PFLH4 A4+2</b>	1	1,63
72A	72A	4	1	<b>LS40 PFLH4 A4+2</b>	1	2,07
85A	85A	4	1	<b>LS55 PFLH4 A4+2</b>	1	2,07
85A	85A	4	1	<b>LS65 PFLH4 A4+2</b>	1	2,07

<sup>1)</sup> **Small Plastic Enclosure:** Type plus Type-suffix „+PF2“

z.B.: **LS.. PFLH4 A2+2 +PF2** (Dimensions see page 325)

# Technical Data

Kind of current	Category	Typical applications	Test conditions for the number of on-load operating cycles (normal service)						Test conditions for making and breaking capacities (operation in fault case)											
			Make			Break			Make			Break								
			I/le	U/Ue	L/R	Ic/le	Ur/Ue	L/R	I/le	U/Ue	L/R	Ic/le	Ur/Ue	L/R						
Direct current	<b>DC21A</b> frequent operation	<b>DC21B</b> infrequent operation	Switching of resistive loads including moderate overloads						1	1	1ms	1	1	1ms	1,5	1,05	1ms	1,5	1,05	1ms
	<b>DC22A</b> frequent operation	<b>DC22B</b> infrequent operation	Switching of mixed resistive a.induct. loads incl. moderate overloads (shunt motors)						1	1	2ms	1	1	2ms	4	1,05	2,5ms	4	1,05	2,5ms
	<b>DC-PV1</b>		Switching of single PV string(s) without reverse- and overcurrents.						1	1	1ms	1	1	1ms	1,5	1,05	1ms	1,5	1,05	1ms
	<b>DC-PV2</b>		Switching of several PV strings with reverse- and overcurrents.						1	1	1ms	1	1	1ms	4	1,05	1ms	4	1,05	1ms

## Data according to IEC 60947-3, VDE 0660, GB/T14048.3 (CCC China)



Main contacts		Typ	LS16	LS25	LS32	LS38	LS40	LS55	
Rated thermal current $I_{th}$		A	16	25	32	45	48	55	
Rated insulation voltage $U_i^{(1)}$		V	1000	1000	1000	1000	1500	1500	
Rated insulation voltage $U_i^{(2)}$		V	1500	1500	1500	1500	1500	1500	
Distance of contacts (per pole)		mm	8	8	8	8	8	8	
<b>DC21A and DC21B</b>	1 pole	300V A	16	23	27	27	40	55	
		400V A	12/14	14/22	16/25	16/25	30/33	40/44	
	A1	500V A	9/10	11/17	13/20	13/20	19/24	25/32	
		600V A	6/7	8/12	10/15	10/15	15/19	20/25	
	1	700V A	4,5/5	6	7,5	7,5	10/12	15/18	
		800V A	3	4	5	5	8/10	10/13	
	only DC21B	900V A	2,5/3	3	4	4	6/8	8/10	
		1000V A	1,5/2	2	2,5/3	2,5/3	4/5	6/8	
	2 poles in series	500V A	16	25	32	-/45	48	55	
		600V A	16	25	32	-/45	48	55	
	A2	700V A	16	23/25	27/32	-/36	35/37	55	
		800V A	16/16	20	-/23	-/30	35	45/55	
	1 2	900V A	13/16	16/17	-/20	-/25	25/31	35/43	
		1000V A	9/10	11/11,5	13	-/20	25/29	-/36	
	1200V A	6/7	8/8,5	10	10	10/11	15/17		
		1500V A	3	4/5	5/6	-/6	6/7,5	7,5/10	
	2 poles in series + 2 poles parallel	500V A	29	45	58	-/65	72	85	
		600V A	29	45	50/55		64/68	80/85	
	A2+2	700V A	16/22	23/27	27/32		35/49	55/77	
		800V A	16/17	20	-/23	-/30	35/42	45/63	
1 2 3 4	900V A	13/16	16/17	-/20		25/31	35/43		
	1000V A	9/10	11/11,5	13	-/20	23/29	25/36		
1200V A	6/7	8/8,5	10	10	10/11	15/17			
	1500V A	3	4/5	5/6	-/6	6/7,5	7,5/10		
3 poles in series + 2 poles parallel	500V A	29	45	58		72	85		
	600V A	29	45	50/58		72	85		
A3+2	700V A	29	38/43	45/55		72	85		
	800V A	29	38/40	-/51		68	85		
1 2 3 4 5 6	900V A	29	-/38	-/47		62	78		
	1000V A	29	-/38	-/45		58	70		
1200V A	12	14/25	16/28						
	1500V A	9	11/14	13/20					
4 poles in series	500V A	16	25	32	-/45	48	55		
	600V A	16	25	32	-/45	48	55		
A4	700V A	16	25	32		40	55		
	800V A	16	25	32		40	55		
1 2 3 4	900V A	16	25	32		40	55		
	1000V A	16	25	32	-/38	40	55		
1200V A	16	25	32		40	55			
	1500V A	16	20/25	23/32	-/32	30/40	40/55		
4 poles in series + 2 poles parallel	500V A	29	45	58	-/65	72	85		
	600V A	29	45	58		72	85		
A4+2	700V A	29	45	-/58		72	85		
	800V A	29	45	-/58		72	85		
1 2 3 4 5 6 7 8	900V A	29	45	-/58		72	85		
	1000V A	29	-/45	-/58	-/65	-/72	-/85		
1200V A	29	-/45	50	-/50	-/56	-/65			
	1500V A	16	20/26	23/32	-/32	-/42	-/55		
<b>Rated operational current <math>I_e</math></b>									
<b>AC21B</b>	A2, A4	$U_e$ max. 440V	A	16	25	32	45	48	55
	A2+2	$U_e$ max. 440V	A	29	45	58		72	85

1) Suitable at overvoltage category I to III, pollution degree 3 (standard-industry):  $U_{imp} = 8kV$ .

2) Suitable at overvoltage category I to III, pollution degree 2 (min. IP55):  $U_{imp} = 8kV$ .

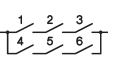
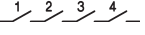
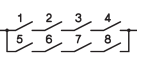

# Technical Data

Data according to IEC 60947-3, VDE 0660

Main contacts	Type		LS16	LS25	LS32	LS38	LS40	LS55	LS65	
<b>Rated operational current I<sub>e</sub></b>										
<b>DC-PV1</b> 1 Pole A1 	300V	A	16	23	27	27	40	55	65	
	400V	A	14	22	25	25	33	44	50	
	500V	A	10	17	20	20	24	32	40	
	600V	A	7	12	15	15	19	25	30	
	700V	A	5	6	7,5	7,5	12	18	21	
	800V	A	3	4	5	5	10	13	15	
	900V	A	3	3	4	4	8	10	10	
	1000V	A	2	2	3	3	5	8	8	
	2 Poles in series A2 	500V	A	16	25	32	45	48	55	75
		600V	A	16	25	32	45	48	55	75
700V		A	16	25	32	36	37	55	75	
800V		A	16	20	23	30	35	55	65	
900V		A	16	17	20	25	31	43	55	
1000V		A	10	11,5	13	20	29	36	40	
1100V		A	8	10	11,5	-	19	25	-	
1200V		A	7	8,5	10	10	11	17	17	
1300V		A	6	7	8	-	10	14	-	
1400V		A	5	6	7	-	9	12	-	
1500V		A	3	5	6	6	8	10	10	
2 Poles in series + 2 Pole parallel A2+2 		500V	A	29	45	58	65	72	85	85
		600V	A	29	45	55	58	68	85	85
		700V	A	22	27	32	36	49	77	80
		800V	A	17	20	23	30	42	63	65
	900V	A	16	17	20	25	31	43	55	
	1000V	A	10	11,5	13	20	29	36	40	
	1100V	A	8	10	11,5	-	19	25	-	
	1200V	A	7	8,5	10	10	11	17	17	
	1300V	A	6	7	8	-	10	14	-	
	1400V	A	5	6	7	-	9	12	-	
	1500V	A	3	5	6	6	8	10	10	
	3 Poles in series + 2 Poles parallel A3+2 	500V	A	29	45	58	-	72	85	-
		600V	A	29	45	58	-	72	85	-
		700V	A	29	43	55	-	72	85	-
		800V	A	29	40	51	-	68	85	-
900V		A	29	38	47	-	62	78	-	
1000V		A	29	38	45	-	58	70	-	
1100V		A	19	27	37	-	-	-	-	
1200V		A	17	25	28	-	-	-	-	
1300V		A	15	21	25	-	-	-	-	
1400V		A	12	18	22	-	-	-	-	
1500V		A	10	14	20	-	-	-	-	
4 Poles in series A4 		500V	A	16	25	32	45	48	55	75
		600V	A	16	25	32	45	48	55	75
		700V	A	16	25	32	45	48	55	75
		800V	A	16	25	32	45	48	55	75
	900V	A	16	25	32	45	48	55	75	
	1000V	A	16	25	32	38	40	55	75	
	1100V	A	16	25	32	32	40	55	65	
	1200V	A	16	25	32	32	40	55	65	
	1300V	A	16	25	32	32	40	55	65	
	1400V	A	16	25	32	32	40	55	65	
	1500V	A	16	25	32	32	40	55	65	
	4 Poles in series + 2 Poles parallel A4+2 	500V	A	29	45	58	65	72	85	85
		600V	A	29	45	58	65	72	85	85
		700V	A	29	45	58	65	72	85	85
		800V	A	29	45	58	65	72	85	85
900V		A	29	45	58	65	72	85	85	
1000V		A	29	45	58	65	72	85	85	
1100V		A	29	45	54	-	60	68	-	
1200V		A	29	45	50	50	56	65	65	
1300V		A	26	39	44	-	50	61	-	
1400V		A	23	33	38	-	46	-	-	
1500V		A	20	26	32	32	42	55	55	

# Technical Data

Data according to IEC 60947-3, VDE 0660

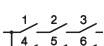
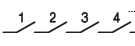
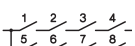
Main contacts	Type		LS16	LS25	LS32	LS38	LS40	LS55	LS65	
<b>Rated operational current I<sub>e</sub></b>										
<b>DC-PV2</b> 1 Pole A1 	300V A	16	23	27	27	40	55	-	-	
	400V A	14	18	20	20	30	40	-	-	
	500V A	10	12	14	14	19	25	-	-	
	600V A	5	6	8	8	10	13	-	-	
	700V A	1,5	2	3	3	7	10	-	-	
	800V A	1,5	2	3	3	6	8	-	-	
	900V A	1	1,5	2	2	5	6	-	-	
	1000V A	1	1,5	2	2	3	4	-	-	
	2 Poles in series A2 	500V A	16	25	32	38	40	55	75	-
		600V A	14	21	27	31	40	55	75	-
700V A		13	19	22	25	35	55	65	-	
800V A		12	15	17	19	33	49	52	-	
900V A		8	10	12	14	25	35	38	-	
1000V A		4	5	6	7	16	20	20	-	
1100V A		3	4	5	-	11	15	-	-	
1200V A		2	3	4	4	8	12	12	-	
1300V A		1,5	2	3	-	7	10	-	-	
1400V A		1	2	3	-	7	9	-	-	
1500V A		1	1,5	2	2	6	8	8	-	
2 Poles in series + 2 Poles parallel A2+2 		500V A	25	39	50	58	72	85	85	-
		600V A	20	32	35	38	60	75	75	-
	700V A	13	19	22	25	38	60	65	-	
	800V A	12	15	17	19	33	49	52	-	
	900V A	8	10	12	14	25	35	38	-	
	1000V A	4	5	6	7	16	20	20	-	
	1100V A	3	4	5	-	11	15	-	-	
	1200V A	2	3	4	4	8	12	12	-	
	1300V A	1,5	2	3	-	7	10	-	-	
	1400V A	1	2	3	-	7	9	-	-	
	1500V A	1	1,5	2	2	6	8	8	-	
	3 Poles in series + 2 Poles parallel A3+2 	500V A	27	45	58	65	72	85	-	-
		600V A	22	34	44	48	72	-	-	-
700V A		20	28	34	35	62	69	-	-	
800V A		18	24	29	31	53	61	-	-	
900V A		16	20	24	24	44	-	-	-	
1000V A		14	18	20	20	35	50	-	-	
1100V A		-	-	-	-	-	-	-	-	
1200V A		11	13	15	15	-	-	-	-	
1300V A		-	-	-	-	-	-	-	-	
1400V A		-	-	-	-	-	-	-	-	
1500V A		4	6	8	8	-	-	-	-	
4 Poles in series A4 		500V A	16	25	32	45	48	55	75	-
		600V A	16	25	32	45	48	55	75	-
	700V A	16	25	32	45	48	55	75	-	
	800V A	16	25	32	38	40	55	75	-	
	900V A	16	25	32	38	40	55	65	-	
	1000V A	16	25	32	38	40	55	65	-	
	1100V A	15	25	32	-	-	55	-	-	
	1200V A	13,5	21	27	27	40	55	55	-	
	1300V A	12	19	24	-	-	50	-	-	
	1400V A	10,5	16	21	-	-	45	-	-	
	1500V A	9	14	18	18	30	40	40	-	
	4 Poles in series + 2 Poles parallel A4+2 	500V A	29	45	58	65	72	85	-	-
		600V A	29	45	58	65	72	85	-	-
700V A		25	40	53	65	72	80	-	-	
800V A		21	35	45	60	67	75	-	-	
900V A		18	30	37	55	59	70	-	-	
1000V A		16	25	32	50	52	64	-	-	
1100V A		-	-	-	-	44	59	-	-	
1200V A		13,5	21	27	27	40	55	-	-	
1300V A		-	-	-	-	36	50	-	-	
1400V A		-	-	-	-	33	45	-	-	
1500V A		9	14	18	18	30	40	40	-	

Contactor, Motor-Starters

Circuit Breakers

Manual Motor-Starters

Switches

AC-Main Switches



DC-Switch Disconnector

Push Buttons

Representatives, Suppliers

# Technical Data



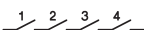



Data according to IEC 60947-3, VDE 0660

Main contacts	Type	LS16	LS25	LS32	LS38	LS40	LS55/LS65
<b>Rated operational current I<sub>e</sub></b>	500V A	1	1,25	1,5	x	x	2,5
<b>DC22B</b>	600V A	0,5	0,75	1	x	x	2,0
1 pole	800V A	0,3	0,4	0,5	x	x	1,5
A1	1000V A	0,15	0,2	0,25	x	x	1,0
	1200V A	-	-	-	x	x	x
	1500V A	-	-	-	x	x	x
2 poles in series	500V A	7	8	9	x	x	x
A2	600V A	5,5	6	6,5	x	x	x
	800V A	2	2,5	3	x	x	x
	1000V A	1	1,5	2	x	x	x
	1200V A	-	-	-	x	x	x
	1500V A	-	-	-	x	x	x
4 poles in series	500V A	16	25	32	x	x	x
A4	600V A	16	25	27,5	x	x	x
	800V A	11,5	12	12,5	x	x	x
	1000V A	8	9	10	x	x	x
	1200V A	-	-	-	x	x	x
	1500V A	-	-	-	x	x	x
<b>Rated conditional short-circuit current</b>	kA <sub>eff</sub>	5	5	5	5	10	10
Max. fuse size	gL (gG)	A 40	63	80	80	125	160
Mechanical life	x10 <sup>3</sup>	10	10	10	10	10	10
Rated short-time withstand current (1s)	I <sub>cw</sub> A2, A4, A6, A8 A2+2, A3+2, A4+2	A 800 A 1300	900 1500	1000 1700	1000 1700	A2, A4: 1200 A2+2: 2000	A2, A4: 1400 A2+2: 2400
Short circuit making capacity	I <sub>cm</sub> A2, A4, A6, A8 A2+2, A3+2, A4+2	A 800 A 1300	900 1500	1000 1700	1000 1700	A2, A4: 1200 A2+2: 2000	A2, A4: 1400 A2+2: 2400
<b>Maximum cable cross sections</b> (incl. jumper)		LSV-B1	LSV-B1	LSV-B1	LSV-B1	LSV-B2	LSV-B2
solid or stranded	mm <sup>2</sup>	4 - 16	4 - 16	4 - 16	4-16	2,5 - 25	2,5 - 25
flexible	mm <sup>2</sup>	4 - 10	4 - 10	4 - 10	4-10	2,5 - 16	2,5 - 16
flexible (+ multicore cable end)	mm <sup>2</sup>	4 - 10	4 - 10	4 - 10	4-10	1,5 - 16	1,5 - 16
Size of terminal screw		M4 Pz2	M4 Pz2	M4 Pz2	M4 Pz2	M5 Pz2	M5 Pz2
Tightening torque	Nm	1,8 - 2	1,8 - 2	1,8 - 2	1,8 - 2	2,5 - 2,8	2,5 - 2,8
2 cables per terminal without jumper LSV-B1 / LSV-B2							
solid or stranded	mm <sup>2</sup>	16+(1,5-2,5) / 10+(1,5-6) / 6+(1,5-10) / 4+(1,5-10)				16+(1,5-2,5) / 10+(1,5-10) / 6+(1,5-10) / 4+(1,5-10)	
flexible & flexible + multicore cable end	mm <sup>2</sup>	16+(1,5-2,5) / 10+(1,5-4) / 6+(1,5-6)				16+(1,5-6) / 10+(1,5-10) / 6+(1,5-16) / 4+(1,5-16)	
stranded	AWG	8+(16-12) / 10+(16-10) / 12+(16-8) 14+(16-8)				3+(18-10) / 4+(18-10) / 6+(18-8) 8+(18-8)	
solid	AWG	10+(16-12) / 12+(16-10) 14+(16-10)				10+(16-10) / 12+(16-10) / 14+(16-10) 12+(16-10)/14+(16-10)	
<b>Maximum ambient temperature</b>							
Operation	open °C	-40 to +65					
	enclosed °C	-40 to +45					
Storage	°C	-50 to +90					
<b>Power loss</b> per switch at I <sub>e</sub> max.		A	A	A		A	A
A2	(A)/W	(16)/ 1	(25)/ 2,3	(32)/ 3,7		(40)/ 4	(55)/ 7,5
A4	(A)/W	(16)/ 2	(25)/ 4,6	(32)/ 7,4		(40)/ 8	(55)/ 15
A6	(A)/W	(16)/ 3	(25)/ 6,9	(32)/ 11,1		(40)/ 12	(55)/ 22,5
A8	(A)/W	(16)/ 4	(25)/ 9,2	(32)/ 14,8		(40)/ 16	(55)/ 30
A2+2	(A)/W	(29)/1,5	(45)/ 3,7	(58)/ 6		(72)/ 6,5	(85)/ 9
A3+2	(A)/W	(29)/2,3	(45)/ 5,6	(58)/ 9		(72)/ 9,8	(85)/ 14
A4+2	(A)/W	(29)/3	(45)/ 7,4	(58)/ 12		(72)/ 13	(85)/ 18
<b>Contact resistance</b> per pole	mΩ	1,75	1,75	1,75		1,25	1,25

x pending

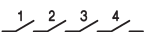
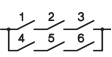
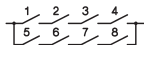



# Technical Data

Daten according to UL5081  File E359344 Category np.: NMSJ and UL508  File E332938, Category no.: NRNT2, NRNT8

Typ				LS16	LS25	LS32	LS38	LS40	LS55	LS65	
Ampere-Rating "General use"  1 Pole	DC	350V	A	4	5	6	6	7,1	10,0	10,0	
		500V	A	4	5	6	6	5,7	7,0	7,0	
		600V	A	4	5	6	6	5,0	5,8	5,8	
		700V	A	-	-	-	-	3,9	5,0	5,0	
		800V	A	-	-	-	-	3,2	4,4	4,4	
		900V	A	-	-	-	-	2,5	3,5	3,5	
		1000V	A	-	-	-	-	1,5	2,0	2,0	
		 2 Poles in series A2	350V	A	16	25	32	45	48	55	65
			500V	A	16	25	32	45	48	55	65
			600V	A	16	25	32	36	40	55	65
700V	A		-	-	-	-	32	46	50		
800V	A		-	-	-	-	26	37	40		
900V	A		-	-	-	-	20	28	32		
1000V	A		-	-	-	-	16	20	25		
 2 Poles in series + 2 Poles parallel A2+2	350V		A	29	45	58	58	72	85	85	
	500V		A	29	41	43	45	53	66	73	
	600V		A	21	30	33	36	42	55	65	
	700V	A	-	-	-	-	35	47	50		
	800V	A	-	-	-	-	30	40	40		
	900V	A	-	-	-	-	26	32	32		
	1000V	A	-	-	-	-	22	25	25		
	 4 Poles in series A4	350V	A	16	25	32	45	48	55	65	
		500V	A	16	25	32	45	48	55	65	
		600V	A	16	25	32	36	40	55	65	
700V		A	-	-	-	-	40	55	65		
800V		A	-	-	-	-	40	55	65		
900V		A	-	-	-	-	40	55	65		
1000V		A	-	-	-	-	40	55	65		
 3 Poles in series + 2 Poles parallel A3+2		350V	A	29	45	58	58	72	85	85	
		500V	A	29	41	50	50	56	80	85	
		600V	A	21	38	45	45	52	65	72	
	700V	A	-	-	-	-	46	58	66		
	800V	A	-	-	-	-	40	51	60		
	900V	A	-	-	-	-	36	45	54		
	1000V	A	-	-	-	-	33	42	48		
	 4 Poles in series + 2 Poles parallel A4+2	350V	A	29	45	58	58	80	85	85	
		500V	A	29	45	58	58	71	85	85	
		600V	A	29	45	50	50	65	85	85	
700V		A	-	-	-	-	58	76	85		
800V		A	-	-	-	-	51	71	76		
900V		A	-	-	-	-	45	67	73		
1000V		A	-	-	-	-	42	64	70		
AC-Rating "General use"		2 Poles in series + 2 Poles parallel	 1 phase 600V	A	16	25	32	-	40	55	-
			 1 phase 277V	A	-	-	50	-	72	85	-
			 3 phase 480V	3 Poles	A	-	-	32	-	40	55
	Fuse size (RK5) Industrial Control Switch			A	40	60	80	80	-	-	-
5kA / 600V	A	-	-	-	-	160	160	160			
5kA/1000V	A	-	-	-	-	160	160	160			
<b>Max. cable cross sections</b> incl. jumpers LSV-B1 / LSV-B2											
solid			AWG	12 - 10	12 - 10	12 - 10	12 - 10	16 - 10	16 - 10		
flexible or stranded			AWG	12 - 6	12 - 6	12 - 6	12 - 6	14 - 3	14 - 3		
flexible (+ multicore cable end)			AWG	12 - 6	12 - 6	12 - 6	12 - 6	16 - 4	16 - 4		
Size of terminal screw				M4 Pz2	M4 Pz2	M4 Pz2	M4 Pz2	M5 Pz2	M5 Pz2		
Tightening torque			Nm	1,8 - 2	1,8 - 2	1,8 - 2	1,8 - 2	2,5 - 2,8	2,5 - 2,8		
Protection class of terminals <sup>1)</sup>				IP20	IP20	IP20	IP20	IP20	IP20		

1) Protection class of the terminals with connected, insulated conductors.

## Approvals

Country	USA, UL5081	US, Canada UL508	Europe	China CCC	CB- Certificates	EAC
Type						
LS16	o	o	/	o	o	o
LS25	o	o	/	o	o	o
LS32	o	o	/	o	o	o
LS38	o	o	/	o	o	o
LS40, LS55	o	o	/	o	o	o
LS65	o	o	/	-	o	o

o In standard version approved

/ No testing required CE

x In test

- Not provided for test

## Technical Data

Example for maximum currents according to ambient temperatures and cable cross sections:

Switch **open** LS16..., 2 contacts in series (A2)

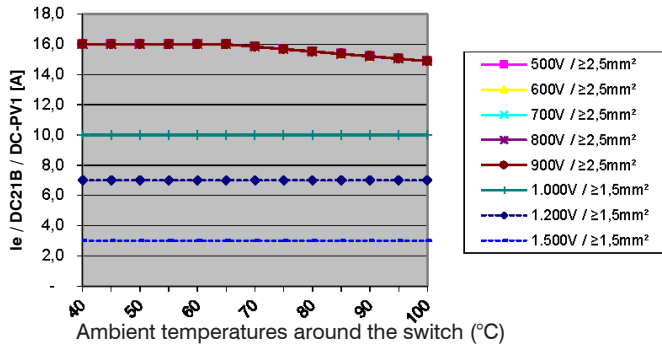

Switch **open** LS16 ..., 2 contacts in series + 2 parallel (A2+2)

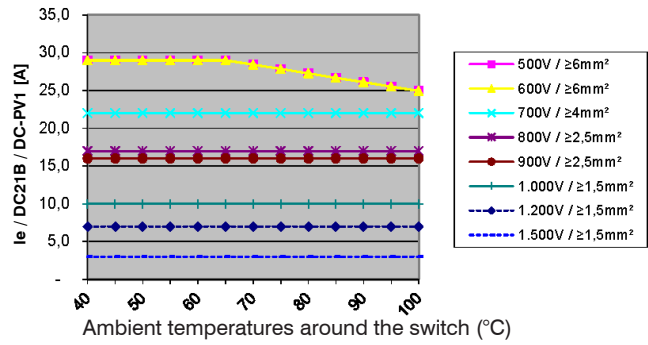

Switch **enclosed** LS16 PFL..., 2 contacts in series (A2)

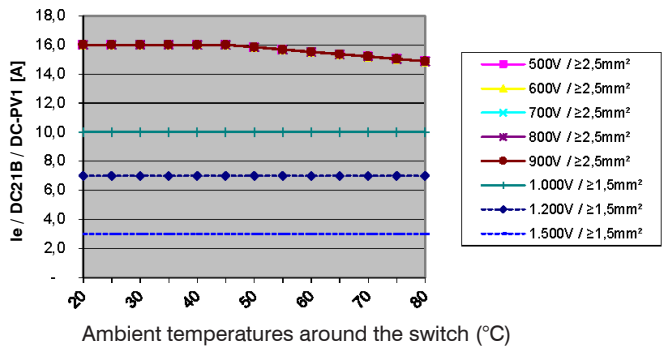

Switch **enclosed** LS16 PFL..., 2 contacts in series + 2 parallel (A2+2)

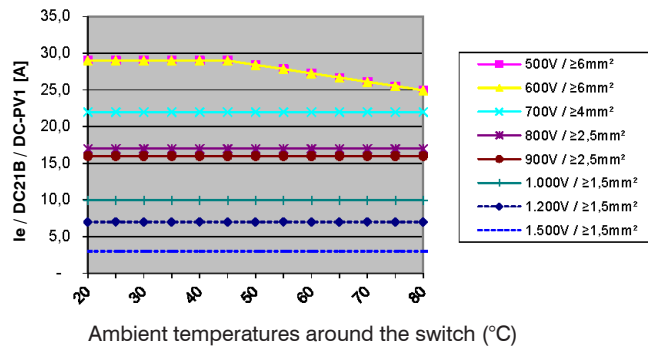

All data about maximum currents according to ambient temperatures and cable cross sections for switches LS16.. to LS65.. (open or enclosed) please find under ➡ [www.benedict.at](http://www.benedict.at) (Button "Customers").

## Dimensions

**LS16 E.., LS25 E.., LS32 E.., LS38E..**  
**..A2**

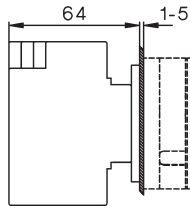
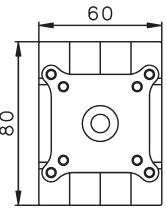
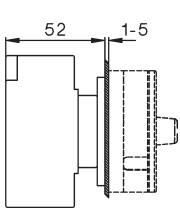

**LS16 E.., LS25 E.., LS32 E.., LS38 E**  
**..A6, ..A8, ..A3+2, ..A4+2**

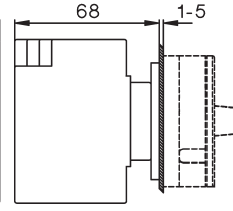
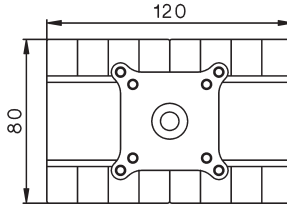

**LS... +VW"x"**  
 Extended Switch Shaft

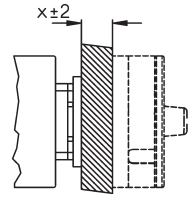

**LS40 E.., LS55 E.., LS65E..**  
**..A2, ..A2+2, ..A4.**

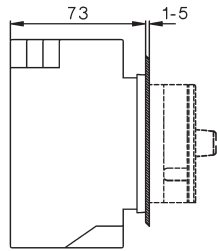
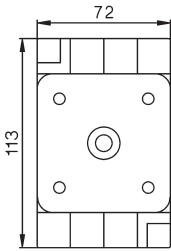

**LS40 E.., LS55 E.., LS65E..**  
**..A6, ..A8, ..A3+2, ..A4+2**

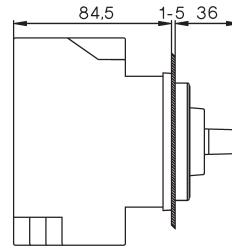
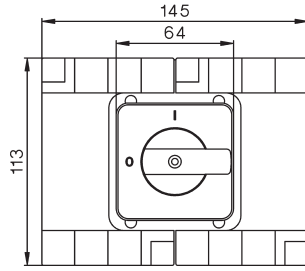

Mounting hole  
 Mounting screw:  
 S3631N M=1,2-1,4 Nm

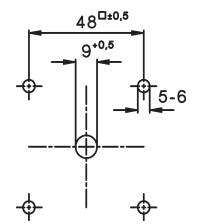

### Escutcheon plate 64<sup>□</sup>

Handle

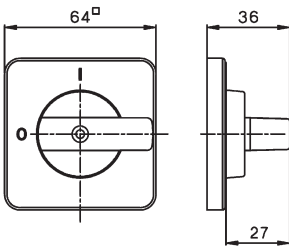

Padlock device SV1.

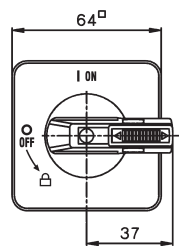

Padlock device SV4.

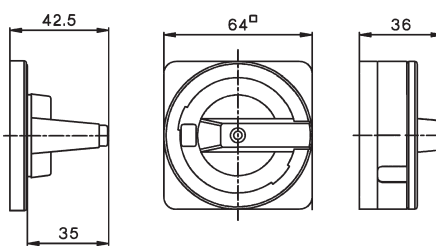

**LS16 Z.., LS25 Z.., LS32 Z.., LS38 Z..**  
**..A2**

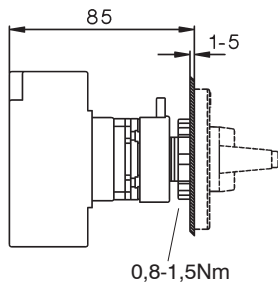
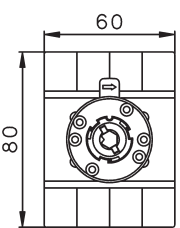

**..A2+2, ..A4.**

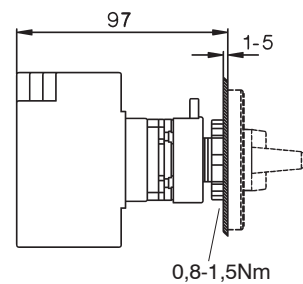
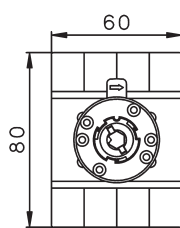

Mounting hole

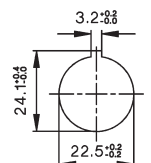

### Escutcheon plate 48<sup>□</sup>

Handle

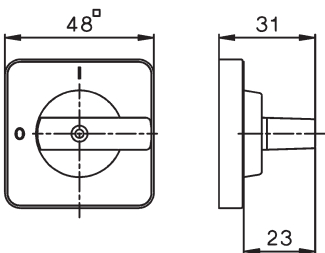

Padlock device SV1.

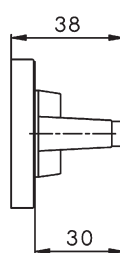
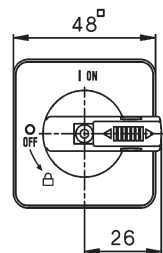

## Dimensions

**LS16 Z., LS25 Z., LS32 Z., LS38 Z.**  
**..A6, ..A8, ..A3+2, ..A4+2**

**LS.. ZO..**

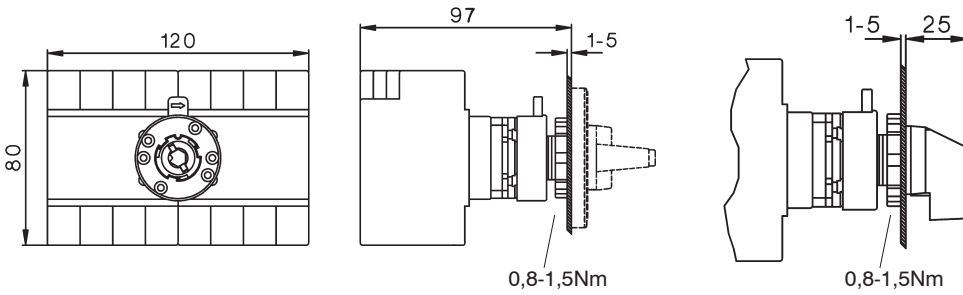

**LS16 VZV., LS25 VZV., LS32 VZV., LS38 VZV.**  
**..A2, ..A2+2, ..A4**

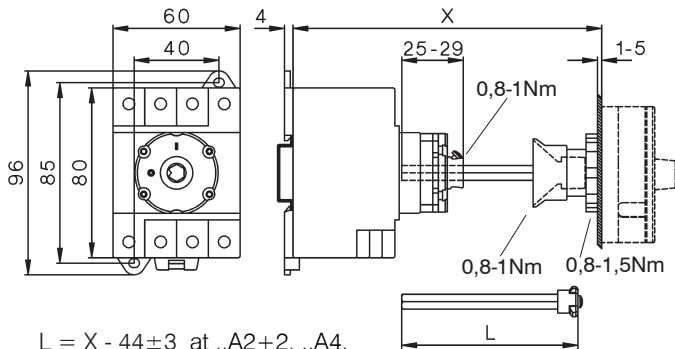

delivered with: ..A2+2, ..A4.

$X_{max.} = 194, L = 150$   
 $(X_{min.} = 89)$

delivered with: ..A2

$X_{max.} = 182, L = 150$   
 $(X_{min.} = 77)$

Bigger X-Dimensions on request

$L = X - 44 \pm 3$  at ..A2+2, ..A4.  
 $L = X - 32 \pm 3$  at ..A2

**LS16 VZV., LS25 VZV., LS32 VZV., LS38 VZV.**  
**..A6, ..A8, ..A3+2, ..A4+2**

Mounting hole

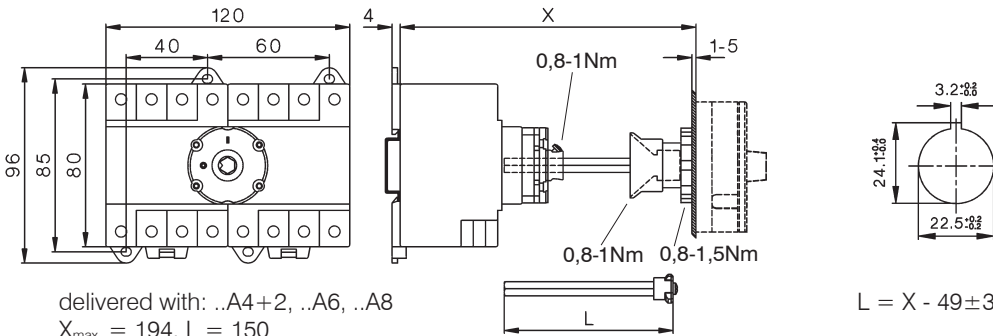

delivered with: ..A4+2, ..A6, ..A8  
 $X_{max.} = 194, L = 150$   
 $(X_{min.} = 95)$

$L = X - 49 \pm 3$

**LS40 VZV., LS55 VZV., LS65 VZV.**  
**..A2, ..A2+2, ..A4.**

**LS40 VZV., LS55 VZV., LS65 VZV.**  
**..A6, ..A8, ..A3+2, ..A4+2**

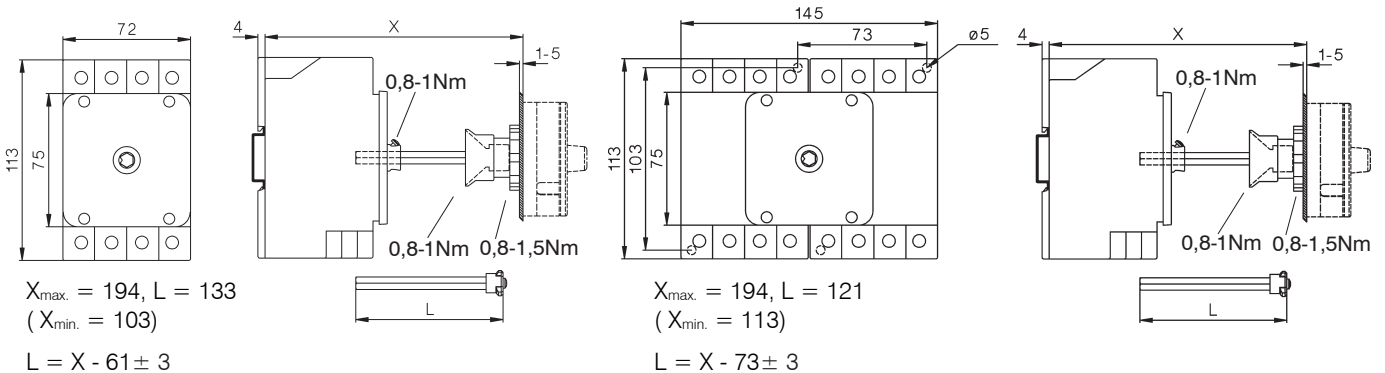

$X_{max.} = 194, L = 133$   
 $(X_{min.} = 103)$

$L = X - 61 \pm 3$

$X_{max.} = 194, L = 121$   
 $(X_{min.} = 113)$

$L = X - 73 \pm 3$

# Dimensions

**LS16 SMA..., LS25 SMA..., LS32 SMA..., LS38 SMA..  
..A2**

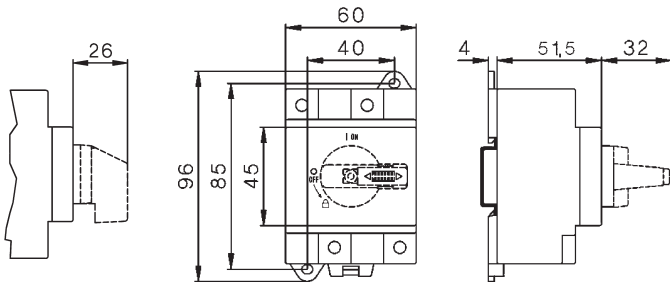

**..A2+2, ..A4**

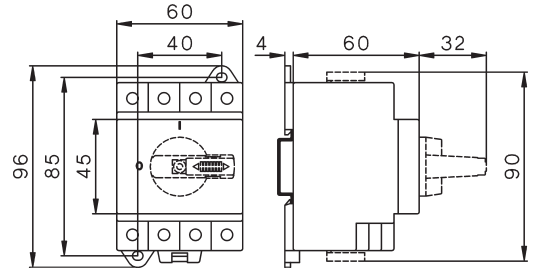

**LS40 SMA..., LS55 SMA..., LS65 SMA..  
..A2, ..A2+2, ..A4**

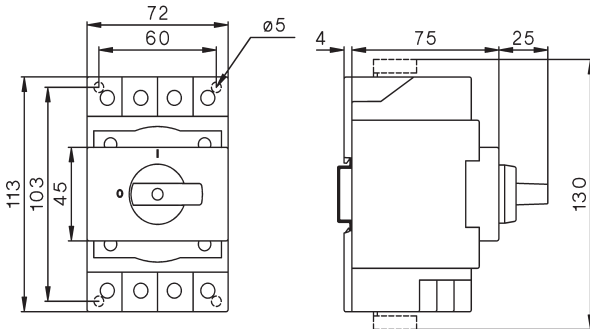

**LS40 SMA..., LS55 SMA..., LS65 SMA..  
..A6, ..A8, ..A3+2, ..A4+2**

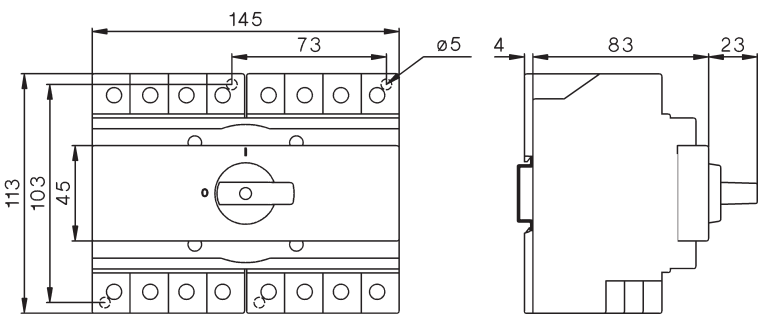

**LS16 SMA..., LS25 SMA..., LS32 SMA..., LS38 SMA..  
..A6, ..A8, ..A3+2, ..A4+2**

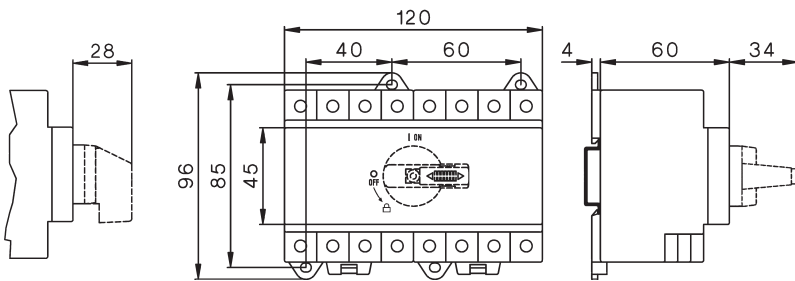

**LS.. SMAH1.. with low height handle  
A2 +SV1N**

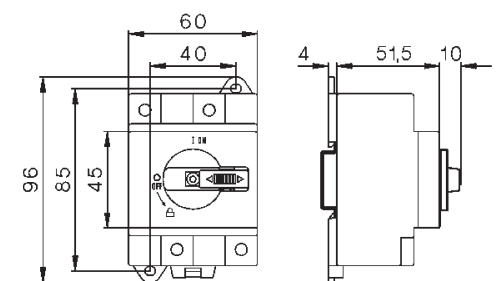

**LS16 SMAH1..., LS25 SMAH1..., LS32 SMAH1..., LS38 SMAH1.. with low height handle  
A2+2 +SV1N, A4 +SV1N**

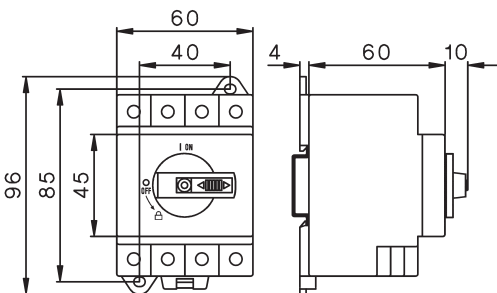

**A4+2 +SV1N, A6 +SV1N, A8 +SV1N**

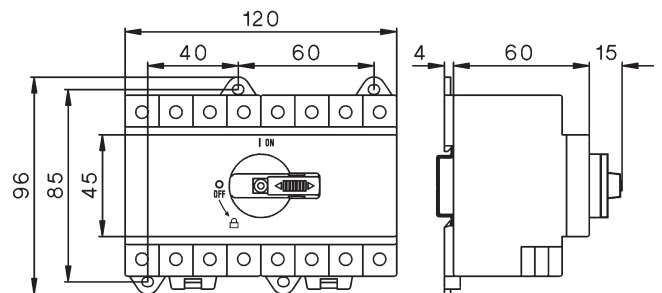

## Dimensions

LS16 PFL..., LS25 PFL..., LS32 PFL..., LS38 PFL..  
..A2, ..A2+2, ..A4.

Main-Switch (lockable)  
LS..PFLH4 A..

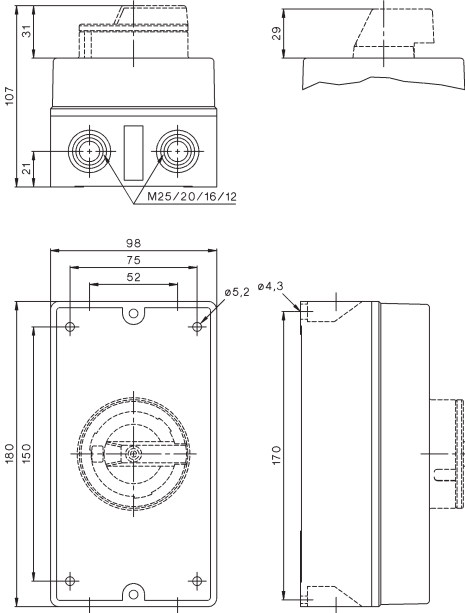

LS16 PFL..., LS25 PFL..., LS32 PFL..., LS38 PFL..  
..A2, ..A2+2, ..A4.  
+ M25

Main-Switch (lockable)  
LS..PFLH4 A..

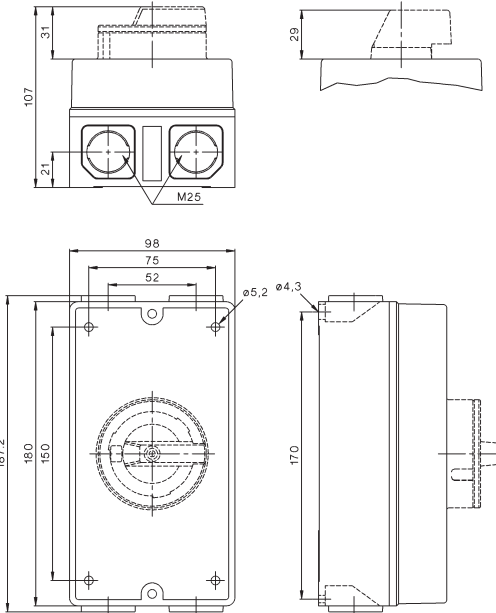

LS16 PFL..., LS25 PFL..., LS32 PFL..., LS38 PFL...,  
..A6, ..A8, ..A3+2, ..A4+2  
LS40 PFL..., LS55 PFL..., LS65 PFL..  
..A2, ..A4, ..A6, ..A8, ..A3+2, ..A4+2

Main-Switch (lockable)  
LS..PFLH4 A..

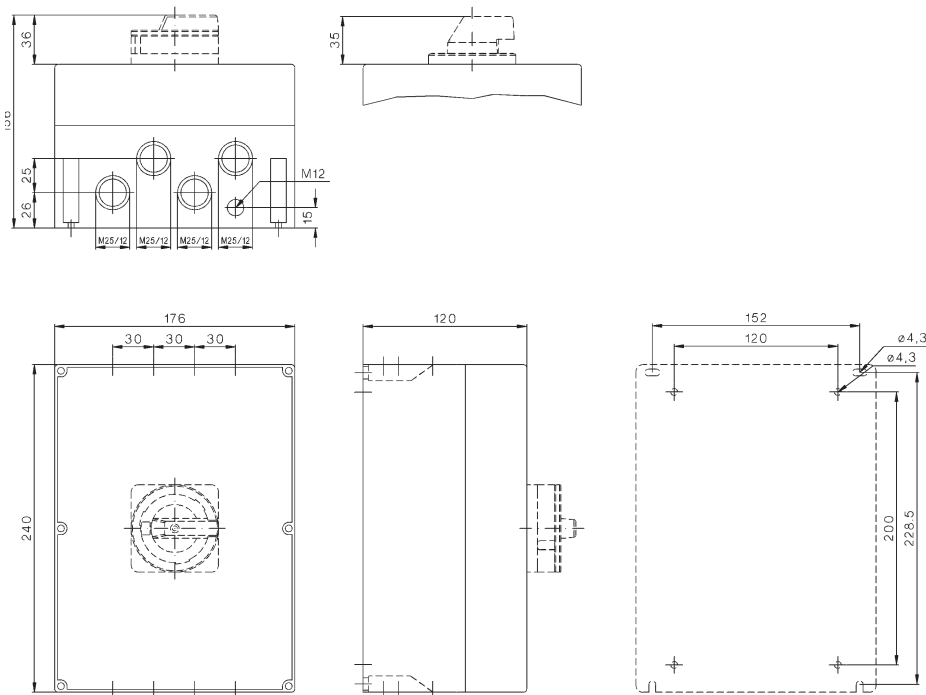

## Dimensions





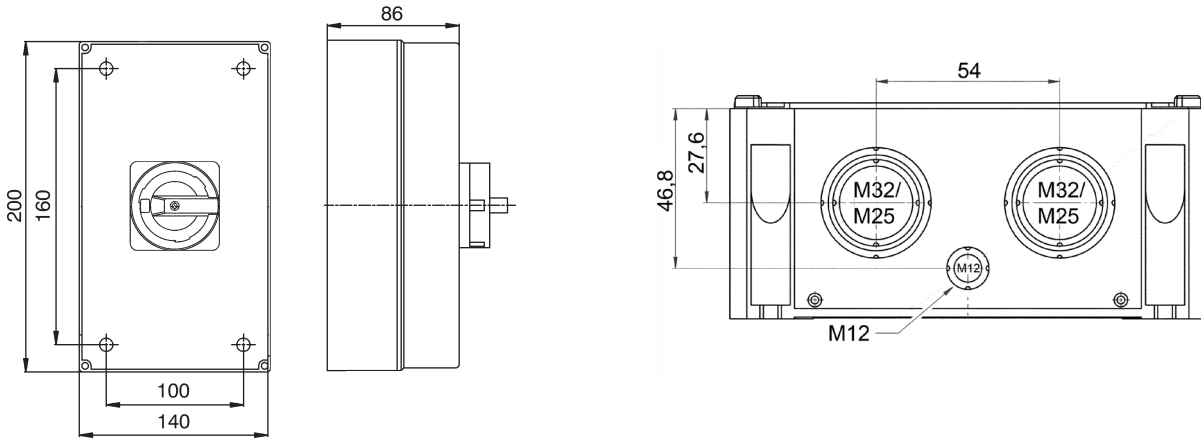



LS40 PFL..., LS55 PFL..., LS65 PFL..  
..A2, ..A4, ..A2+2

Main switch (lockable)  
LS..PFLH4 A.. +PF2



## Insulated jumpers LSV-.. for series- and parallel switching of contacts:

for switches	Type	Pack	Weight
LS16, LS25, LS32, LS38	LSV-B1-1	100	7,0 g/pcs.
LS16, LS25, LS32, LS38	LSV-B1-2	100	12,0 g/pcs.
LS40, LS55, LS65	LSV-B2-1	100	9,0 g/pcs.
LS40, LS55, LS65	LSV-B2-2	100	17,0 g/pcs.

Typ	LS16	LS25	LS32	LS38	LS40	LS55	LS65
A40 A4U A4B	2 x  LSV-B1-1 N		2 x  LSV-B1-2 N		2 x  LSV-B2-2 N		
A2+2	4 x  LSV-B1-1 N				4 x  LSV-B2-1 N		
A4+2	8 x  LSV-B1-1 N				8 x  LSV-B2-1 N		
	2 x  LSV-B1-2 N				2 x  LSV-B2-2 N		

Applications:

LS16-38 VZV.. A2+2      LS16-32 VZV.. A40      LS38 VZV.. A40      LS16-38 VZV.. A4+2



2x LSV-B1-1



4x LSV-B1-1

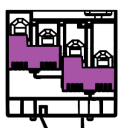
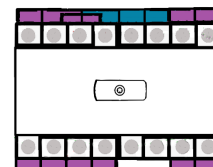
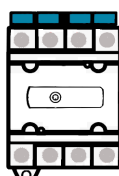
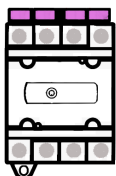
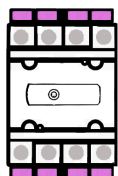

2x LSV-B1-1

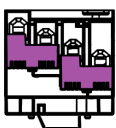

2x LSV-B1-1

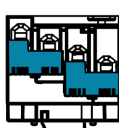

2x LSV-B1-2

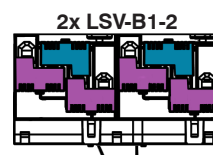

2x LSV-B1-2

4x LSV-B1-1

LS40-65 VZV.. A2+2      LS40-65 VZV.. A40      LS40-65 VZV.. A4+2



2x LSV-B2-1

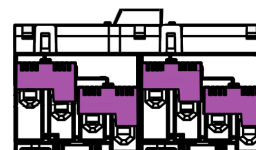

4x LSV-B2-1

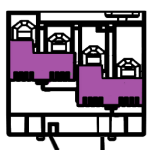
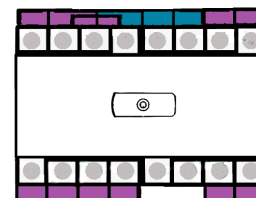
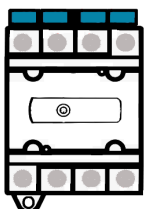
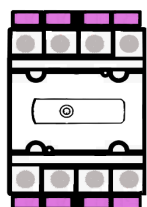

2x LSV-B2-1





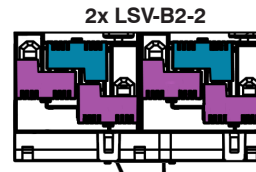











2x LSV-B2-2



2x LSV-B2-2

4x LSV-B2-1

Further applications for switches LS16.. to LS65.. please find under [www.benedict.at](http://www.benedict.at) (Button "Certificates/Declarations").

Index		Page
	<b>Program B3</b>	328
	Push Buttons	329
	EMERGENCY STOP Buttons	330
	Key Operated Rotary Switches	331
	Rotary Knobs and Swing Knobs	331
	Illuminated Rotary Knobs and Swing Knobs	332
	Illuminated Push Buttons	332
	Double Push Buttons	332
	Lens Caps	333
	Monoblock-Multi-LEDs	333
	Push Button-Sets	334
	Illuminated Push Button-Sets	334
	Pilot Lights-Sets	335
	Connectors	336
	Insert Actuator	336
	Contact Blocks and Lamp Holders	336
	Lamps, LED Lamps	337
	Accessories	337
	Label Holder, Legend Plates, Actuator Caps	338
<hr/>		
	<b>Program B5</b>	340
	Push Buttons	341
	Rotary Knobs and Swing Knobs	342
	Key Operated Rotary Switches	343
	Illuminated Push Buttons	343
	Lens Caps	343
	Connectors	344
	Contact Blocks and Lamp Holders	344
	Lamps, Accessories	345
<hr/>		
	<b>Units for Surface Mounting</b>	347
	Assembled Units IP65	347
<hr/>		
	<b>Enclosures BG.</b>	348
	Contact Blocks and Lamp Holders for Enclosures BG..	348
		348
<hr/>		
	<b>Push Buttons for Enclosures</b>	349
	Extensions for Push Buttons	349
<hr/>		
	<b>Technical Data</b>	
	Approvals	350
	Dimensions	351

Actuators and Lens Caps 22mm IP67 (IP65),  Type 12

Push Buttons



EMERGENCY STOP Buttons



Illuminated Operators



Double Push Buttons with Indicator Lamp, IP65

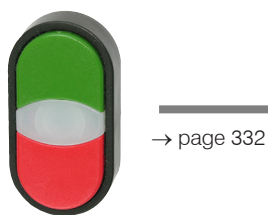

Lens Caps



Mono Block Multi Chip LED IP65, IEC 60947, EN 60947

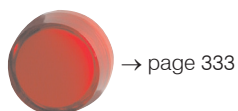

Mounting hole  
Ø 22,5mm

with key way

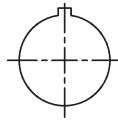

without key way

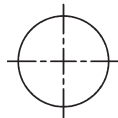

Connectors

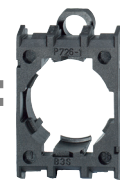

or



Contacts  
Lamp Holders

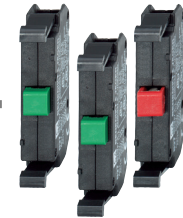

Actuator insert  
→ page 336

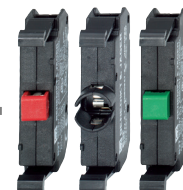

LED  
24-230V



Filament  
6-130V



Glow-discharge  
230V  
→ page 337

Wrech for Actuators  
Lens Caps and  
Mono Block Multi Chip LED  
J7049



## Actuators 22mm IP67, Type 12

Ring



Colour Symbol

Alu

Black

Chrome

Pack pcs. Weight kg/pc.

Push Buttons, Actuator Caps markable see page 337



red		B3D RT	BS3D RT	BC3D RT	10	0,014
red	0	B3D RT-0	BS3D RT-0	BC3D RT-0	10	0,014
green		B3D GN	BS3D GN	BC3D GN	10	0,014
grün	I	B3D GN-I	BS3D GN-I	BC3D GN-I	10	0,014
grün	II	B3D GN-II	BS3D GN-II	BC3D GN-II	10	0,014
grün	→	B3D GN-PF	BS3D GN-PF	BC3D GN-PF	10	0,014
yellow		B3D GE	BS3D GE	BC3D GE	10	0,014
blue		B3D BL	BS3D BL	BC3D BL	10	0,014
white		B3D WS	BS3D WS	BC3D WS	10	0,014
black		B3D SW	BS3D SW	BC3D SW	10	0,014
black	→	B3D SW-PF	BS3D SW-PF	BC3D SW-PF	10	0,014

Push Buttons, Maintained, Actuator Caps markable see page 339



red		B3DR RT	BS3DR RT	BC3DR RT	10	0,014
green		B3DR GN	BS3DR GN	BC3DR GN	10	0,014
yellow		B3DR GE	BS3DR GE	BC3DR GE	10	0,014
blue		B3DR BL	BS3DR BL	BC3DR BL	10	0,014
white		B3DR WS	BS3DR WS	BC3DR WS	10	0,014
black		B3DR SW	BS3DR SW	BC3DR SW	10	0,014

Mushroom Head Ø28mm



red		B3P1 RT	BS3P1 RT	BC3P1 RT	10	0,017
red	0	B3P1 RT-0	BS3P1 RT-0	BC3P1 RT-0	10	0,017
green		B3P1 GN	BS3P1 GN	BC3P1 GN	10	0,017
yellow		B3P1 GE	BS3P1 GE	BC3P1 GE	10	0,017
blue		B3P1 BL	BS3P1 BL	BC3P1 BL	10	0,017
black		B3P1 SW	BS3P1 SW	BC3P1 SW	10	0,017

Mushroom Head Ø40mm



red	0	B3P14 RT-0	BS3P14 RT-0	BC3P14 RT-0	10	0,020
-----	---	------------	-------------	-------------	----	-------

Mushroom Head Ø40mm

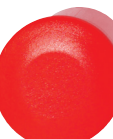



red		BS3P44T RT	BS3P44T RT	BS3P44T RT	10	0,028
-----	--	------------	------------	------------	----	-------

Foot and Palm switch Ø70mm



red		BS3P14P RT	BS3P14P RT	BS3P14P RT	1	0,062
grey		BS3P14P GR	BS3P14P GR	BS3P14P GR	1	0,062

## Actuators 22mm IP67, Type 12

Ring	Colour	Symbol/ high	 Alu	 Black	 Chrome	Pack pcs.	Weight kg/pc
------	--------	-----------------	---	---	--	--------------	-----------------

**EMERGENCY STOP Push Buttons**, according to EN ISO 13850, push to trip, pull to release Ø40mm



red	30mm	BS3P44 RT	BS3P44 RT	BS3P44 RT	10	0,028
red	38mm	BS3P45 RT	BS3P45 RT	BS3P45 RT	10	0,028

**EMERGENCY STOP Push Buttons**, according to EN ISO 13850, release by key, Ø40mm



red	38mm	BS3P44S3	BS3P44S3	BS3P44S3	1	0,050
-----	------	----------	----------	----------	---	-------

Spare Key	lock Ronis R455			B4-R455	1	0,007
-----------	-----------------	--	--	---------	---	-------

**EMERGENCY STOP Push Buttons**, release by turning, Ø28mm



red		B3P3 RT	BS3P3 RT	BC3P3 RT	10	0,017
red	0	B3P3 RT-0	BS3P3 RT-0	BC3P3 RT-0	10	0,017
red	0	B3P3 RT-0-RGE <sup>2)</sup>	BS3P3 RT-0-RGE <sup>2)</sup>	BC3P3 RT-0-RGE <sup>2)</sup>	10	0,017

**EMERGENCY STOP Push Buttons**, release by turning, Ø40mm



red	0	B3P34 RT-0	BS3P34 RT-0	BC3P34 RT-0	10	0,020
-----	---	------------	-------------	-------------	----	-------



red	Pfeile	B3P34 RT-PF	BS3P34 RT-PF	BC3P34 RT-PF	10	0,020
-----	--------	-------------	--------------	--------------	----	-------

red illuminated		B3P34L RT	BS3P34L RT	BC3P34L RT	10	0,020
--------------------	--	-----------	------------	------------	----	-------

**EMERGENCY STOP Push Buttons**, release by turning, Ø70mm



red		BS3P34P RT	BS3P34P RT	BS3P34P RT	1	0,062
-----	--	------------	------------	------------	---	-------

**Yellow Disk Ø70mm, Thickness 1mm <sup>1)</sup>**



neutral				B3-7603	1	0,004
with marking NOT-AUS and EMERGENCY-STOP-symbol				B3-7603-1	1	0,004
with marking EMERGENCY STOP and EMERGENCY-STOP-symbol				B3-7603-2	1	0,004
2-side markings: ARRET D`URGENCE / NOODSTOP with E-STOP-symbol				B3-7603-3	1	0,004
2-side markings: ARRET D`URGENCE / NØDSTOP with E-STOP-symbol				B3-7603-4	1	0,004



**Protection cover against unintentional manipulation, Thickness 1mm**



for Push Buttons Ø28mm and Ø40mm	yellow		B3-SK GE	1	0,04
----------------------------------	--------	--	----------	---	------

**Sealing cap**

for Push Buttons BS3P45RT and BS3P44S3	transparent		B3-PH GE	1	0,03
--	-------------	--	----------	---	------

1) Not for enclosure BG.. 2) Front ring yellow

# Actuators 22mm Type 12

Ring



Knob

Alu

Black

Chrome

Pack pcs.

Weight kg/pc.

## Rotary Knobs and Swing Knobs, black IP65



Rotary



Swing

maintained 60°



Rotary  
Swing

B3KN2  
B3KRN2

BS3KN2  
BS3KRN2

BC3KN2  
BC3KRN2

10  
10

0,020  
0,020

maintained 60°



Rotary

B3KN29

BS3KN29

BC3KN29

10

0,020

spring return 60°



Rotary  
Swing

B3KN8  
B3KRN8

BS3KN8  
BS3KRN8

BC3KN8  
BC3KRN8

10  
10

0,020  
0,020

spring return 60°



Rotary  
Swing

B3KN1  
B3KRN1

BS3KN1  
BS3KRN1

BC3KN1  
BC3KRN1

10  
10

0,020  
0,020

maintained 60°



Rotary  
Swing

B3KN3  
B3KRN3

BS3KN3  
BS3KRN3

BC3KN3  
BC3KRN3

10  
10

0,020  
0,020

maintained/spring return 60°



Rotary

B3KN6

BS3KN6

BC3KN6

10

0,020

spring return/maintained 60°



Rotary

B3KN7

BS3KN7

BC3KN7

10

0,020

maintained 120°



Rotary

B3KN9

BS3KN9

BC3KN9

10

0,020

maintained 90°  
according to EN81



Rotary

B3KN10

BS3KN10

BC3KN10

10

0,020

maintained 90°



Rotary

B3KN11

BS3KN11

BC3KN11

10

0,020

## Illuminated Rotary Knobs and Swing Knobs, clear IP67, lamp max. 1,2W, lamps see page 339



Rotary



Swing

Toggle IP65



maintained 90°



Rotary

B3KL2

BS3KL2

BC3KL2

10

0,016

spring return 60°



Rotary  
Swing

B3KL1  
B3KRL1

BS3KL1  
BS3KRL1

BC3KL1  
BC3KRL1

10  
10

0,016  
0,016

maintained 60°



Rotary  
Swing

B3KL3  
B3KRL3

BS3KL3  
BS3KRL3

BC3KL3  
BC3KRL3

10  
10

0,016  
0,016

maintained/spring return 60°



Rotary

B3KL6

BS3KL6

BC3KL6

10

0,016

O - I

B3E

BS3E

BC3E

10

0,017

# Actuators 22mm IP65, Type 12

Ring

Key  
removeable in



Alu



Black



Chrome

Pack  
pcs.

Weight  
kg/pc.

## Key Operated Rotary Switches with lock Ronis 455



B3SAR 0

maintained 60°

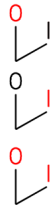

B3SAR 0

BS3SAR 0

BC3SAR 0

1

0,044

B3SAR 1

BS3SAR 1

BC3SAR 1

1

0,044

B3SAR 01

BS3SAR 01

BC3SAR 01

1

0,044

spring return 60°



B3SAT 0

BS3SAT 0

BC3SAT 0

1

0,044



B3SARR 0

maintained 60°



B3SARR 0

BS3SARR 0

BC3SARR 0

1

0,044

B3SARR 102

BS3SARR 102

BC3SARR 102

1

0,044

spring return/maintained 60°



B3SATR 02

BS3SATR 02

BC3SATR 02

1

0,044

spring return 60°



B3SATT 0

BS3SATT 0

BC3SATT 0

1

0,044

Spare Key lock Ronis R455

B4-R455

1

0,007

Colour Symbol

Pack  
pcs.

Weight  
kg/pc.

## Illuminated Push Buttons IP67, lamp max. 1,9W, lamps see page 339



red

B3DL RT

BS3DL RT

BC3DL RT

10

0,014

green

B3DL GN

BS3DL GN

BC3DL GN

10

0,014

yellow

B3DL GE

BS3DL GE

BC3DL GE

10

0,014

blue

B3DL BL

BS3DL BL

BC3DL BL

10

0,014

white

B3DL WS

BS3DL WS

BC3DL WS

10

0,014

## Illuminated Push Buttons, Maintained IP67, lamp max. 1,9W, lamps see page 339



red

B3DLR RT

BS3DLR RT

BC3DLR RT

10

0,014

green

B3DLR GN

BS3DLR GN

BC3DLR GN

10

0,014

yellow

B3DLR GE

BS3DLR GE

BC3DLR GE

10

0,014

blue

B3DLR BL

BS3DLR BL

BC3DLR BL

10

0,014

white

B3DLR WS

BS3DLR WS

BC3DLR WS

10

0,014

## Double Push Buttons, with indicator lamp white, lamp max. 1,9W, lamps see page 339



green

B3DT G/R <sup>1)</sup>

BS3DT G/R

BC3DT G/R

10

0,016

red

white

B3DT W/S <sup>1)</sup>

BS3DT W/S

BC3DT W/S

10

0,016

black

green

I

B3DT GI/RO <sup>1)</sup>

BS3DT GI/RO

BC3DT GI/RO

10

0,016

red

0

white

I

B3DT WI/SO <sup>1)</sup>

BS3DT WI/SO

BC3DT WI/SO

10

0,016

black

0

with non-standard marking on request

1) Plastic ring in alu design.

# Lens Caps 22mm Type 4X

suitable for Alu, Black and Chrome

Colour	Type	Pack pcs.	Weight kg/pc.
--------	------	-----------	---------------

Lens Caps IP67 with fresnel lens, lamp max. 1,9W, lamps see page 339, laser marking on request



red	B3R RT	10	0,009
green	B3R GN	10	0,009
yellow	B3R GE	10	0,009
blue	B3R BL	10	0,009
clear	B3R KL	10	0,009
white	B3R WS	10	0,009

Lens Caps Low IP67 with fresnel lens, lamp max. 1,9W, lamps see page 339, laser marking on request



red	B3RN RT	10	0,008
green	B3RN GN	10	0,008
yellow	B3RN GE	10	0,008
blue	B3RN BL	10	0,008
clear	B3RN KL	10	0,008
white	B3RN WS	10	0,008

Lens Caps IP67, lamp max. 1,9W, lamps see page 337, laser marking on request



red	B3RF RT	10	0,009
green	B3RF GN	10	0,009
yellow	B3RF GE	10	0,009
blue	B3RF BL	10	0,009
white	B3RF WS	10	0,009

Colour	Voltage	Power VA	W	Type	Pack pcs.	Weight kg/pc
--------	---------	----------	---	------	-----------	--------------



Monoblock LEDs IP65, IEC 60947, EN 60947 (6 years middle lifetime) <sup>1)</sup>



red	20-30V AC/DC	0,4	0,4	B3-MB24 RTB	10	0,022
green	20-30V AC/DC	0,4	0,4	B3-MB24 GNB	10	0,022
yellow	20-30V AC/DC	0,4	0,4	B3-MB24 GEB	10	0,022
blue	20-30V AC/DC	0,4	0,4	B3-MB24 BLB	10	0,022
white	20-30V AC/DC	0,4	0,4	B3-MB24 WSB	10	0,022
red	110-130V AC 110V DC	1,2	1,2	B3-MB110 RTB	10	0,022
green	110-130V AC 110V DC	1,2	1,2	B3-MB110 GNB	10	0,022
yellow	110-130V AC 110V DC	1,2	1,2	B3-MB110 GEB	10	0,022
blue	110-130V AC 110V DC	1,2	1,2	B3-MB110 BLB	10	0,022
white	110-130V AC 110V DC	1,2	1,2	B3-MB110 WSB	10	0,022
red	170-250V AC	4,0	1,0	B3-MB230 RTB	10	0,022
green	170-250V AC	4,0	1,0	B3-MB230 GNB	10	0,022
yellow	170-250V AC	4,0	1,0	B3-MB230 GEB	10	0,022
blue	170-250V AC	4,0	1,0	B3-MB230 BLB	10	0,022
white	170-250V AC	4,0	1,0	B3-MB230 WSB	10	0,022
red	400V AC		0,5	B3-MB400 RTB	10	0,022
green	400V AC		0,5	B3-MB400 GNB	10	0,022
yellow	400V AC		0,5	B3-MB400 GEB	10	0,022
blue	400V AC		0,5	B3-MB400 BLB	10	0,022
white	400V AC		0,5	B3-MB400 WSB	10	0,022

1) Ambient temperatures on request.

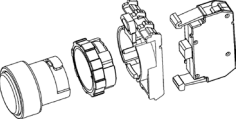
## Push Button 22mm-Sets, with Contact Block and Connector

Actuator Colour	Symbol	with	Type	Pack pcs.	Weight kg/pc.
<b>Push Buttons, IP67</b>					
	black	+connector +1NO	BS3D SW/10	1	0,037
	green	+connector +1NO	BS3D GN/10	1	
	yellow	+connector +1NO	BS3D GE/10	1	0,037
	blue	+connector +1NO	BS3D BL/10	1	0,037
	red	+connector +1NC	BS3D RT/01	1	
	green	 +connector +1NO	BS3D GN-I/10	1	0,037
	red	 +connector +1NC	BS3D RT-0/01	1	0,037





## Double Push Buttons, IP65

	green/ red	+connector +1NO +1NC	BS3DT G/R/11	1	0,049
--	------------	----------------------	--------------	---	-------







## EMERGENCY STOP Push Buttons, IP67 Ø40mm

	pull to release acc. EN ISO 13850	+connector +1NO +1NC	BS3P44 RT/11	1	0,061
	key release acc. EN ISO 13850	+connector +1NO +1NC	BS3P44S3 RT/11	1	0,083
	twist release	+connector +1NO +1NC	BS3P34 RT-0/11	1	0,053

## Rotary Knobs, IP65

		+connector +1NO	BS3KN2/10	1	0,043
		+connector +1NO +1NC	BS3KN2/11	1	0,053
		+connector +2NO	BS3KN3/20	1	0,053
		+connector +2NO	BS3KN1/20	1	0,053

## Key Operated Rotary Switch with lock Ronis 455, IP65

		key removeable in 0-position +connector +1NO	BS3SAR 0/10	1	0,057
		key removeable in all positions +connector +1NO	BS3SAR 01/10	1	0,057
		key removeable in 0-position +connector +1NO	BS3SAT 0/10	1	0,057
		key removeable in all positions +connector +2NO	BS3SARR 102/20	1	0,067
		key removeable in 0-position +connector +2NO	BS3SARR 0/20	1	0,067

# Illuminated Push Button 22mm-Sets, with Contact Block, Connector and LED

Actuator Colour	with	LED	Type	Pack pcs.	Weight kg/pc.
-----------------	------	-----	------	-----------	---------------

## Illuminated Push Buttons, IP67



white	+connector +1NO +1NC +LED	20-30V AC/DC	BS3DL WS/11/L24	1	0,054
green	+connector +1NO +1NC +LED	20-30V AC/DC	BS3DL GN/11/L24	1	0,054
red	+connector +1NO +1NC +LED	20-30V AC/DC	BS3DL RT/11/L24	1	0,054
yellow	+connector +1NO +1NC +LED	20-30V AC/DC	BS3DL GE/11/L24	1	0,054
blue	+connector +1NO +1NC +LED	20-30V AC/DC	BS3DL BL/11/L24	1	0,054

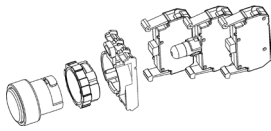

white	+connector +1NO +1NC +LED	90-120V AC/DC	BS3DL WS/11/L110	1	0,054
green	+connector +1NO +1NC +LED	90-120V AC/DC	BS3DL GN/11/L110	1	0,054
red	+connector +1NO +1NC +LED	90-120V AC/DC	BS3DL RT/11/L110	1	0,054
yellow	+connector +1NO +1NC +LED	90-120V AC/DC	BS3DL GE/11/L110	1	0,054
blue	+connector +1NO +1NC +LED	90-120V AC/DC	BS3DL BL/11/L110	1	0,054

white	+connector +1NO +1NC +LED	200-250V AC/DC	BS3DL WS/11/L230	1	0,054
green	+connector +1NO +1NC +LED	200-250V AC/DC	BS3DL GN/11/L230	1	0,054
red	+connector +1NO +1NC +LED	200-250V AC/DC	BS3DL RT/11/L230	1	0,054
yellow	+connector +1NO +1NC +LED	200-250V AC/DC	BS3DL GE/11/L230	1	0,054
blue	+connector +1NO +1NC +LED	200-250V AC/DC	BS3DL BL/11/L230	1	0,054

## Double Push Buttons with Pilot Light, IP65



green/ red	+connector +1NO +1NC +LED	20-30V AC/DC	BS3DT G/R/11/L24	1	0,066
green/ red	+connector +1NO +1NC +LED	90-120V AC/DC	BS3DT G/R/11/L110	1	0,066
green/ red	+connector +1NO +1NC +LED	200-250V AC/DC	BS3DT G/R/11/L230	1	0,066

## Pilot Lights, IP67 with socket BA9S (without lamp)



white	+connector +socket BA9S	-	B3R WS/0	1	0,037
green	+connector +socket BA9S	-	B3R GN/0	1	0,037
red	+connector +socket BA9S	-	B3R RT/0	1	0,037
yellow	+connector +socket BA9S	-	B3R GE/0	1	0,037

## Pilot Lights with LEDs, IP67



white	+connector +socket BA9S	20-30V AC/DC	B3R WS/L24	1	0,042
green	+connector +socket BA9S	20-30V AC/DC	B3R GN/L24	1	0,042
red	+connector +socket BA9S	20-30V AC/DC	B3R RT/L24	1	0,042
yellow	+connector +socket BA9S	20-30V AC/DC	B3R GE/L24	1	0,042
white	+connector +socket BA9S	90-120V AC/DC	B3R WS/L110	1	0,042
green	+connector +socket BA9S	90-120V AC/DC	B3R GN/L110	1	0,042
red	+connector +socket BA9S	90-120V AC/DC	B3R RT/L110	1	0,042
yellow	+connector +socket BA9S	90-120V AC/DC	B3R GE/L110	1	0,042
white	+connector +socket BA9S	200-250V AC/DC	B3R WS/L230	1	0,042
green	+connector +socket BA9S	200-250V AC/DC	B3R GN/L230	1	0,042
red	+connector +socket BA9S	200-250V AC/DC	B3R RT/L230	1	0,042
yellow	+connector +socket BA9S	200-250V AC/DC	B3R GE/L230	1	0,042

## Connectors

Specification	Description	Type	Pack pcs.	Weight kg/pc.
Connector B3S		B3S	10	0,013

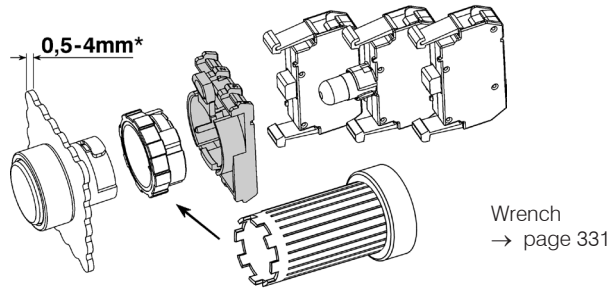

Connector B3M		B3M	10	0,013
---------------	--	-----	----	-------

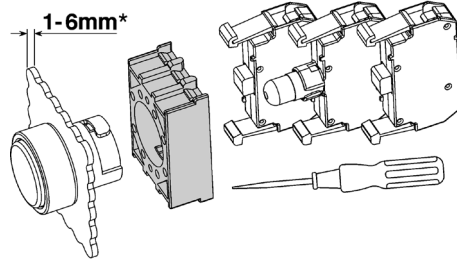

\*) inclusive Thickness from Label Holder and Yellow Disk

## Contact Blocks and Lamp Holders for Panel Mounting

for voltage	Description	Type	Pack pcs.	Weight kg/pc.
-------------	-------------	------	-----------	---------------

### Contact blocks, screw terminals



max. 690V AC	1 NC <sup>1)</sup>		B3T01 <sup>2)</sup>	10	0,010
max. 690V AC	1 NO <sup>1)</sup>		B3T10 <sup>2)</sup>	10	0,010

### Contact blocks, RAST 5 terminals (note coding)

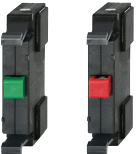

max. 690V~	1 NC		B3RT01	10	0,010
max. 690V~	1 NO		B3RT10	10	0,010

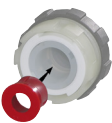

Actuator insert	to actuate the center contact block		P642	10	0,001
-----------------	-------------------------------------	--	------	----	-------

### Lamp holders, socket BA9s



max. 440V AC/DC	direct connection, for lamps max. 1,9W (active power consumption)			B3F	10	0,012
-----------------	---	--	--	-----	----	-------

### Lamp holders for lamp test circuits, socket BA9s



max. 440V AC	direct connection, for filament and glow-discharge lamps max. 1,7W (active power consumption)			B3FT	10	0,020
max. 250V	direct connection of LED			B3FTD	10	0,020

1) NC contact has a positive opening according to IEC/EN 60947-5-1.

2) Contact blocks with gold contacts (B3T..G) on request, suitable for 17V= / 1 mA and for difficult ambient conditions.

## Lamps

Socket BA9s  
Lamp voltage

Type

Pack  
pcs.

Weight  
kg/pc.

### LED lamps<sup>2) 3)</sup> (6 years middle lifetime, for equivalent lens caps only)



24V 10mA AC/DC +-10%	for red lens caps	B3-L24 RTB	50	0,005
24V 10mA AC/DC +-10%	for green lens caps	B3-L24 GNB	50	0,005
24V 10mA AC/DC +-10%	for yellow lens caps	B3-L24 GEB	50	0,005
24V 10mA AC/DC +-10%	for blue lens caps	B3-L24 BLB	50	0,005
24V 10mA AC/DC +-10%	for white lens caps	B3-L24 WSB	50	0,005
110V 3,2mA AC/DC +-10%	for red lens caps	B3-L110 RTB	50	0,005
110V 3,2mA AC/DC +-10%	for green lens caps	B3-L110 GNB	50	0,005
110V 3,2mA AC/DC +-10%	for yellow lens caps	B3-L110 GEB	50	0,005
110V 3,2mA AC/DC +-10%	for blue lens caps	B3-L110 BLB	50	0,005
110V 3,2mA AC/DC +-10%	for white lens caps	B3-L110 WSB	50	0,005
220V 1,7mA AC/DC +-10%	for red lens caps	B3-L230 RTB	50	0,005
220V 1,7mA AC/DC +-10%	for green lens caps	B3-L230 GNB	50	0,005
220V 1,7mA AC/DC +-10%	for yellow lens caps	B3-L230 GEB	50	0,005
220V 1,7mA AC/DC +-10%	for blue lens caps	B3-L230 BLB	50	0,005
220V 1,7mA AC/DC +-10%	for white lens caps	B3-L230 WSB	50	0,005

### Filament lamps<sup>3)</sup>



Power consumption					
24V	1,2W	for all lens caps	B4-G24	100	0,005
42V	1W	for all lens caps	B4-G42	100	0,005
48V	1,2W	for all lens caps	B4-G48	100	0,005
60V	1,2W	for all lens caps	B4-G60	100	0,005

### Glow-discharge lamps<sup>3)</sup>



220-250V AC	0,3W	for clear, red, yellow lens caps	B4-GL230K	100	0,005
220-250V AC	0,3W	for green, blue lens caps	B4-GL230G	100	0,005

## Accessories



		Type	Pack pcs.	Weight kg/pc.	
Wrench	for mounting of actuators and lens caps B(S)3..	J7049	1	0,018	
Marking plate	for marking of contact blocks B3T. and lamp holders B3F	P672-1	10	0,001	
Lamp Installer	used to install or replace lamps BA9s	B4-7408	1	0,010	
Spare Key	for B(S)3SA.. and BS3P44S3, Ronis R455 for B(S)3SB.., Ronis R786	B4-R455 B4-R786	1 1	0,007 0,007	
Hole Plug	black, for fixing holes	B3-DU SW	10	0,007	
	grey	Ø22,5mm B3-DU GR	10	0,007	
Protection cover	against unintentional manipulation				
	Thickness 1mm	yellow	B3-SK GE	1	0,04
	Thickness 1mm	grey	B3-SK GR	1	0,04
Protection ring with thread	against unintentional manipulation has to be mounted instead of the existing ring	black	P921-1	1	0,012

1) Voltage marking 130V / 2W max. rated voltage 120V / 1,8W.

2) Suitable for B3FT lamp test holders.

3) Ambient temperatures on request.

## Label Holders and Legend Plates for Push Buttons B3, 22mm

### Marking 1 or 2 lines



	Type	Pack pcs.	Weight kg/pc.
Label holder for legend plate BK4, black, Thickness 0,8mm	P751	100	0,001
Label holder for legend plate BK4, yellow, Thickness 0,8mm	P751-3	10	0,001

marking	Type	marking	Type	Pack pcs.	Weight kg/pc.
---------	------	---------	------	-----------	---------------

#### Legend plate alu, for label holder P751



blank	BK4-9736			100	0,0002
I	BK4-I	II	BK4-II	10	0,0002
III	BK4-III	IV	BK4-IV	10	0,0002
V	BK4-V			10	0,0002



→	BK4--->	←	BK4-<--	10	0,0002
0 I	BK4-0-I	H 0 A	BK4-H 0 A	10	0,0002
0 I	BK4-0__I	1 0 2	BK4-1 0 2	10	0,0002



START	BK4-START	STOP	BK4-STOP	10	0,0002
EIN	BK4-EIN	AUS	BK4-AUS	10	0,0002
BETRIEB	BK4-BETRIEB	STÖRUNG	BK4-STÖRUNG	10	0,0002



VOR	BK4-VOR	ZURÜCK	BK4-ZURÜCK	10	0,0002
HEBEN	BK4-HEBEN	SENKEN	BK4-SENKEN	10	0,0002
LINKS	BK4-LINKS	RECHTS	BK4-RECHTS	10	0,0002

MEHR	BK4-MEHR	WENIGER	BK4-WENIGER	10	0,0002
SCHNELL	BK4-SCHNELL	LANGSAM	BK4-LANGSAM	10	0,0002
HELLER	BK4-HELLER	DUNKLER	BK4-DUNKLER	10	0,0002

AUF	BK4-AUF	ZU	BK4-ZU	10	0,0002
AB	BK4-AB	HALT	BK4-HALT	10	0,0002
EILGANG	BK4-EILGANG	TIPPEN	BK4-TIPPEN	10	0,0002

#### Legend plate with non-standard marking (e. g.: BK4-MOTOR-START)

Text 1 line, max. 11 letters, letter height 3mm	BK4-...	1	0,0002
Text 2 lines, max. 2 x 11 letters, letter height 3mm	BK4-...-...	1	0,0002

#### Legend plate yellow, for label holder P751-3



Legend plate yellow without marking	BK4-10827	10	0,0002
Legend plate yellow with marking NOT-AUS	BK4-10827-1	10	0,0002
Legend plate yellow with marking EMERGENCY STOP	BK4-10827-2	10	0,0002
Legend plate yellow with marking ARRET D`URGENCE	BK4-10827-3	10	0,0002

### Marking 3 or 4 lines



Label holder for legend plate BK8, black, Thickness 0,8mm	P761	10	0,0013
Label holder for legend plate BK8, yellow, Thickness 0,8mm	P761-3	10	0,0013
Label holder for BK8, for double push buttons only	P761-DT	10	0,0013

#### Legend plate BK8 for label holder P761 (with marking e. g.: BK8-WATER-PUMP-START)



Legend plate without marking	BK8-9736	10	0,0004
Text 3 lines, max. 3 x 11 letters, letter height 3mm	BK8-...-...-...	10	0,0004
Text 4 lines, max. 4 x 11 letters, letter height 3mm	BK8-...-...-...	10	0,0004

# Actuator Caps with Laser Markings

## Codes for colours

Colour	for buttons		for illuminated buttons	
	B3D(R)	B5D(R)	B3DL(R)	B5DL(R)
red	DK RT..	BS5D(R)	DKL RT..	BS5DL(R)
green	DK GN..	BS5D(R)	DKL GN..	BS5DL(R)
yellow	DK GE..	BC5D(R)	DKL GE..	BC5DL(R)
blue	DK BL..		DKL BL..	
white	DK WS..		DKL WS..	
black	DK SW..		-	

## Actuator Caps with text, the Suffix must be completed with the colour code



Marking	Suffix for Marking	Marking	Suffix for Marking	Pack pcs.	Weight kg/pc.
START	...-START	NOT AUS	...-NOT-AUS	10	0,001
EIN	...-EIN	STOP	...-STOP	10	0,001
		AUS	...-AUS	10	0,001
BETRIEB	...-BETRIEB	STÖRUNG	...-STÖRUNG	10	0,001
ANLAUF	...-ANLAUF	HALT	...-HALT	10	0,001
VOR	...-VOR	ZURÜCK	...-ZURÜCK	10	0,001
HEBEN	...-HEBEN	SENKEN	...-SENKEN	10	0,001
LINKS	...-LINKS	RECHTS	...-RECHTS	10	0,001
MEHR	...-MEHR	WENIGER	...-WENIGER	10	0,001
SCHNELL	...-SCHNELL	LANGSAM	...-LANGSAM	10	0,001
HELLER	...-HELLER	DUNKLER	...-DUNKLER	10	0,001
AUF	...-AUF	ZU	...-ZU	10	0,001
AB	...-AB	LAUF	...-LAUF	10	0,001
EILGANG	...-EILGANG	TIPPEN	...-TIPPEN	10	0,001

## Actuator Caps with symbols according to ISO 7000, the Suffix must be completed with the colour code

Symbol	Suffix for Marking	ISO 7000 reference no.	Symbol	Suffix for Marking	ISO 7000 reference no.	Pack pcs.	Weight kg/pc.
	...-100	-		...-101	-	10	0,001
	...-102	-		...-103	-	10	0,001
	...-200	0011		...-201	0244	10	0,001
	...-202	-		...-203	-	10	0,001
	...-204	0355		...-205	-	10	0,001
	...-300	-		...-301	-	10	0,001
	...-302	-		...-303	-	10	0,001
	...-304	-		...-305	0259	10	0,001
	...-306	-		...-307	-	10	0,001
	...-400	-		...-401	0018	10	0,001
	...-402	0019		...-403	0020	10	0,001
	...-404	0021		...-405	0022	10	0,001
	...-406	0023		...-407	0910	10	0,001
	...-408	-		...-409	0096	10	0,001
	...-410	0017		...-411	0033	10	0,001
	...-412	0032		...-413	-	10	0,001

# Actuators and Lens Caps 30mm IP67 (IP65)

## Push Buttons



→ page 341



IP65  
→ page 342,  
343

## EMERGENCY STOP Buttons

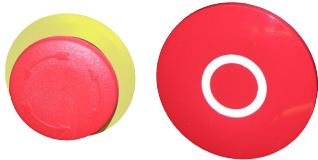

→ page 341



→ page 341

## Illuminated Operators



→ page 342



→ page 345

## Lens Caps



→ page 343



Wrench  
J7049

Mounting hole  
Ø 30,5mm

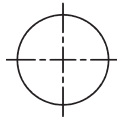

## Connectors



Tthickness  
**0,5 - 3 mm**  
→ page 344

## Contacts Lamp Holder

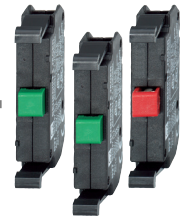

Actuator insert  
→ page 344

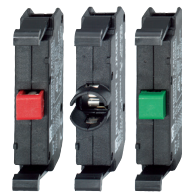

→ page 344



LED  
24-230V



Filament  
6-130V



Glow-discharge  
230V

→ page 345

# Actuators 30mm IP67

Ring



Colour      Symbol      Alu      Black      Chrome      Pack pcs.      Weight kg/pc.

## Push Buttons, Actuator Caps markable



red		B5D RT	BS5D RT	BC5D RT	10	0,029
red	0	B5D RT-0	BS5D RT-0	BC5D RT-0	10	0,029
green		B5D GN	BS5D GN	BC5D GN	10	0,029
green	I	B5D GN-I	BS5D GN-I	BC5D GN-I	10	0,029
green	II	B5D GN-II	BS5D GN-II	BC 5D GN-II	10	0,029
green	→	B5D GN-PF	BS5D GN-PF	BC5D GN-PF	10	0,029



yellow		B5D GE	BS5D GE	BC5D GE	10	0,029
blue		B5D BL	BS5D BL	BC5D BL	10	0,029
white		B5D WS	BS5D WS	BC 5D WS	10	0,029
black		B5D SW	BS5D SW	BC5D SW	10	0,029
black	→	B5D SW-PF	BS5D SW-PF	BC5D SW-PF	10	0,029

## Push Buttons, Maintained, Actuator Caps markable



red		B5DR RT	BS5DR RT	BC5DR RT	10	0,029
green		B5DR GN	BS5DR GN	BC5DR GN	10	0,029
yellow		B5DR GE	BS5DR GE	BC5DR GE	10	0,029
blue		B5DR BL	BS5DR BL	BC5DR BL	10	0,029
white		B5DR WS	BS5DR WS	BC5DR WS	10	0,029
black		B5DR SW	BS5DR SW	BC5DR SW	10	0,029

## Mushroom Heads, Ø28mm



red		B5P1 RT	BS5P1 RT	BC5P1 RT	10	0,032
red	0	B5P1 RT-0	BS5P1 RT-0	BC5P1 RT-0	10	0,032
green		B5P1 GN	BS5P1 GN	BC5P1 GN	10	0,032
yellow		B5P1 GE	BS5P1 GE	BC5P1 GE	10	0,032
blue		B5P1 BL	BS5P1 BL	BC5P1 BL	10	0,032
black		B5P1 SW	BS5P1 SW	BC5P1 SW	10	0,032

## Mushroom Heads, Ø40mm



red	0	B5P14 RT-0	BS5P14 RT-0	BC5P14 RT-0	10	0,035
-----	---	------------	-------------	-------------	----	-------

## EMERGENCY STOP Push Buttons, Ø 28mm, release by turning, with yellow ring



red		B5P3 RT-RGE			10	0,032
red	0	B5P3 RT-0-RGE			10	0,032

## EMERGENCY STOP Push Buttons, Ø 40mm, release by turning



red	0	B5P34 RT-0	BS5P34 RT-0	BC5P34 RT-0	10	0,035
-----	---	------------	-------------	-------------	----	-------

## Yellow Disk for EMERGENCY-STOP Push Buttons, Ø70mm, Thickness 1mm



neutral		B5-7603			1	0,004
with marking NOT-HALT-symbol		B5-7603-S			1	0,004



with marking NOT-AUS		B5-7603-1			1	0,004
with marking EMERGENCY STOP		B5-7603-2			1	0,004

## Actuators 30mm

Ring

Knob

Alu

Black

Chrome

Pack  
pcs.

Weight  
kg/pc.

### Rotary Knobs and Swing Knobs, black IP65



Rotary

maintained 60°



Rotary  
Swing

**B5KN2**  
**B5KRN2**

**BS5KN2**  
**BS5KRN2**

**BC5KN2**  
**BC5KRN2**

10  
10

0,035  
0,035

spring return 60°



Rotary  
Swing

**B5KN8**  
**B5KRN8**

**BS5KN8**  
**BS5KRN8**

**BC5KN8**  
**BC5KRN8**

10  
10

0,035  
0,035

spring return 60°



Rotary  
Swing

**B5KN1**  
**B5KRN1**

**BS5KN1**  
**BS5KRN1**

**BC5KN1**  
**BC5KRN1**

10  
10

0,035  
0,035

spring return 60°



Rotary  
Swing

**B5KN3**  
**B5KRN3**

**BS5KN3**  
**BS5KRN3**

**BC5KN3**  
**BC5KRN3**

10  
10

0,035  
0,035

maintained/spring return 60°



Rotary

**B5KN6**

**BS5KN6**

**BC5KN6**

10

0,035

spring return/maintained 60°



Rotary

**B5KN7**

**BS5KN7**

**BC5KN7**

10

0,035

maintained 120°



Rotary

**B5KN9**

**BS5KN9**

**BC5KN9**

10

0,035

maintained 90°  
according to EN81



Rotary

**B5KN10**

**BS5KN10**

**BC5KN10**

10

0,035

### Illuminated Rotary Knobs and Swing Knobs IP67, clear, lamp max. 1,2W, lamps see page 347



Rotary

maintained 90°



Rotary

**B5KL2**

**BS5KL2**

**BC5KL2**

10

0,031

spring return 60°



Rotary  
Swing

**B5KL1**  
**B5KRL1**

**BS5KL1**  
**BS5KRL1**

**BC5KL1**  
**BC5KRL1**

10  
10

0,031  
0,031

maintained 60°



Rotary  
Swing

**B5KL3**  
**B5KRL3**

**BS5KL3**  
**BS5KRL3**

**BC5KL3**  
**BC5KRL3**

10  
10

0,031  
0,031

maintained/spring return 60°



Rotary

**B5KL6**

**BS5KL6**

**BC5KL6**

10

0,031



Swing

### Toggle IP65

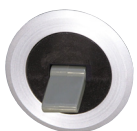

O - I

**B5E**

**BS5E**

**BC5E**

10

0,032

# Actuators and Lens Caps 30mm IP65

Ring

key  
removeable in



Alu



Black



Chrome

Pack  
pcs.

Weight  
kg/pc.

## Key Operated Rotary Switch with lock Ronis 455



B3SAR 0



B3SARR 0

maintained 60°

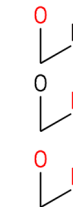

B5SAR 0

BS5SAR 0

BC5SAR 0

1

0,059

B5SAR 1

BS5SAR 1

BC5SAR 1

1

0,059

B5SAR 01

BS5SAR 01

BC5SAR 01

1

0,059

spring return 60°



B5SAT 0

BS5SAT 0

BC5SAT 0

1

0,059

maintained 60°



B5SARR 0

BS5SARR 0

BC5SARR 0

1

0,059

B5SARR 102

BS5SARR 102

BC5SARR 102

1

0,059

spring return/maintained 60°



B5SATR 02

BS5SATR 02

BC5SATR 02

1

0,059

spring return 60°



B5SATT 0

BS5SATT 0

BC5SATT 0

1

0,059

Spare Keylock Ronis R455

B4-R455

1

0,007

Colour

Pack  
pcs.

Weight  
kg/pc.

## Illuminated Push Buttons IP67, lamp max. 1,9W, lamps see page 347



red

B5DL RT

BS5DL RT

BC5DL RT

10

0,029

green

B5DL GN

BS5DL GN

BC5DL GN

10

0,029

yellow

B5DL GE

BS5DL GE

BC5DL GE

10

0,029

blue

B5DL BL

BS5DL BL

BC5DL BL

10

0,029

white

B5DL WS

BS5DL WS

BC5DL WS

10

0,029

## Illuminated Push Buttons IP67, Maintained, lamp max. 1,9W, lamps see page 347



red

B5DLR RT

BS5DLR RT

BC5DLR RT

10

0,029

green

B5DLR GN

BS5DLR GN

BC5DLR GN

10

0,029

yellow

B5DLR GE

BS5DLR GE

BC5DLR GE

10

0,029

blue

B5DLR BL

BS5DLR BL

BC5DLR BL

10

0,029

white

B5DLR WS

BS5DLR WS

BC5DLR WS

10

0,029

## Lens Caps with fresnel lens IP67, lamp max. 1,9W, lamps see page 347



red

B5R RT

BS5R RT

BC5R RT

10

0,029

green

B5R GN

BS5R GN

BC5R GN

10

0,029

yellow

B5R GE

BS5R GE

BC5R GE

10

0,029

blue

B5R BL

BS5R BL

BC5R BL

10

0,029

clear

B5R KL

BS5R KL

BC5R KL

10

0,029

white

B5R WS

BS5R WS

BC5R WS

10

0,029

## Connectors

Specification	Description	Type	Pack pcs.	Weight kg/pc.
Connector B3S		B3S	10	0,013

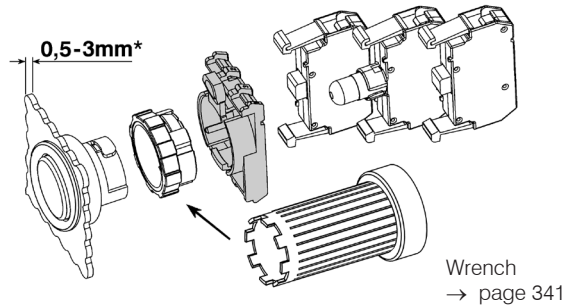

\*) inclusive Thickness from Label Holder and Yellow Disk

## Contact Blocks and Lamp Holders for Panel Mounting

for voltage	Description	Type	Pack pcs.	Weight kg/pc.
max. 690V AC	1 NC	B3T01 <sup>2)</sup>	10	0,010
max. 690V AC	1 NO	B3T10 <sup>2)</sup>	10	0,010
max. 690V~	1 NC <sup>1)</sup>	B3RT01 <sup>2)</sup>	10	0,010
max. 690V~	1 NO	B3RT10 <sup>2)</sup>	10	0,010
Actuator insert	to actuate the center contact block	P642	10	0,001

### Contact blocks

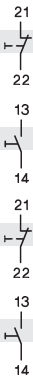
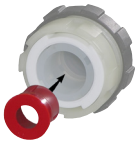

### Lamp holders, socket BA9s



max. 440V AC/DC	direct connection, for lamps max. 1,9W (active power consumption)			B3F	10	0,012
-----------------	---	--	--	-----	----	-------

### Lamp holders for lamp test circuits, socket BA9s



max. 440V AC	direct connection, for filament and glow-discharge lamps max. 1,7W (active power consumption)			B3FT	10	0,020
max. 250V	direct connection of LED			B3FTD	10	0,020

1) NC contact has a positive opening according to IEC/EN 60947-5-1

2) Contact blocks with gold contacts ( B3T..G) on request, suitable for 17V= /1mA and for difficult ambient conditions.

## Lamps

Socket BA9s Lamp voltage	Power consumption	Type	Pack pcs.	Weight kg/pc.
-----------------------------	----------------------	------	--------------	------------------

### LED lamps <sup>2) 3)</sup> (6 years middle lifetime, for equivalent lens caps only)



20-30V AC/DC	17mA / 0,4W	for red lens caps	B3-L24 RTB	50	0,005
20-30V AC/DC	17mA / 0,4W	for green lens caps	B3-L24 GNB	50	0,005
20-30V AC/DC	17mA / 0,4W	for yellow lens caps	B3-L24 GEB	50	0,005
20-30V AC/DC	17mA / 0,4W	for blue lens caps	B3-L24 BLB	50	0,005
20-30V AC/DC	17mA / 0,4W	for white lens caps	B3-L24 WSB	50	0,005
90-120V AC/DC	7mA / 0,8W	for red lens caps	B3-L110 RTB	50	0,005
90-120V AC/DC	7mA / 0,8W	for green lens caps	B3-L110 GNB	50	0,005
90-120V AC/DC	7mA / 0,8W	for yellow lens caps	B3-L110 GEB	50	0,005
90-120V AC/DC	7mA / 0,8W	for blue lens caps	B3-L110 BLB	50	0,005
90-120V AC/DC	7mA / 0,8W	for white lens caps	B3-L110 WSB	50	0,005
200-250V AC/DC	4mA / 0,9W	for red lens caps	B3-L230 RTB	50	0,005
200-250V AC/DC	4mA / 0,9W	for green lens caps	B3-L230 GNB	50	0,005
200-250V AC/DC	4mA / 0,9W	for yellow lens caps	B3-L230 GEB	50	0,005
200-250V AC/DC	4mA / 0,9W	for blue lens caps	B3-L230 BLB	50	0,005
200-250V AC/DC	4mA / 0,9W	for white lens caps	B3-L230 WSB	50	0,005

### Filament lamps <sup>3)</sup>



24V	1,2W	for all lens caps	B4-G24	100	0,005
42V	1W	for all lens caps	B4-G42	100	0,005
48V	1,2W	for all lens caps	B4-G48	100	0,005
60V	1,2W	for all lens caps	B4-G60	100	0,005

### Glow-discharge lamps <sup>3)</sup>



220-250V AC	0,3W	for clear, red, yellow lens caps	B4-GL230K	100	0,005
220-250V AC	0,3W	for green, blue lens caps	B4-GL230G	100	0,005

1) Voltage marking 130V / 2W max. rated voltage 120V / 1,8W.

2) Suitable for B3FT lamp test holders.

3) Ambient temperatures on request.

## Accessories



	Type	Pack pcs.	Weight kg/pc.
<b>Wrench</b>	for mounting of actuators and lens caps B(S)3..	J7049	1 0,018
<b>Marking plate</b>	for marking of contact blocks B3T. and lamp holders B3F	P672-1	10 0,001
<b>Lamp Installer</b>	used to install or replace lamps BA9s	B4-7408	1 0,010
<b>Spare Key</b>	for B(S)3SA.. and BS3P44S3, Ronis R455 for B(S)3SB.., Ronis R786	B4-R455 B4-R786	1 0,007 1 0,007
<b>Protectiv cover sealable</b>	against unintentional manipulation of buttons B5, ( <i>not for mushroom heads, rotary and swing knobs</i> )	B5-SAP	1 0,008
<b>Label holder for legend plate BK5, black, 1 or 2 lines</b>		P942-1	10 0,0013
<b>Legend plate BK5 with for label holder P942-1 (with marking e. g.: BK5-MOTOR-START)</b>		BK5-11374	10 0,0003
<b>Legend plate alu without marking for label holder P42-1</b>	Text 1 or 2 lines, max. 2 x 13 letters, letter height 3mm		
<b>Label holder for legend plate BK10, black, 3 or 4 lines</b>		P1043	10 0,0015
<b>Legend plate BK10 with for label holder P1043 (with marking e. g.: BK10-WATER-PUMP-START)</b>		BK10-11724	10 0,0005
<b>Legend plate alu without marking for label holder P1043</b>	Text 3 or 4 lines, max. 4 x 13 letters, letter height 3mm		
<b>Adapter to convert Actuators 22mm to 30mm</b>			
	alu	B5	10 0,017
	black	BS5	10 0,017
	chrome	BC5	10 0,017

## Assembled Stations BG.. IP67 Type 12

- A Actuators or Lens caps, see page 325 – 328
- B Legend plates with label holder
- C Ring and nut (included with actuator or lens cap)
- D Contact blocks and lamp holders, see page 344
- E Rear shroud
- F Function number
- G Cover
- H Pre-moulded knockouts in rear wall
- K Captive screws (after screw in), at delivery loose
- L Sign of units at the ground of the rear wall
- M Pre-moulded knockouts for conduit hubs
- N Sequence number
- O Spring-catches for snap in Contact blocks and lamp holders

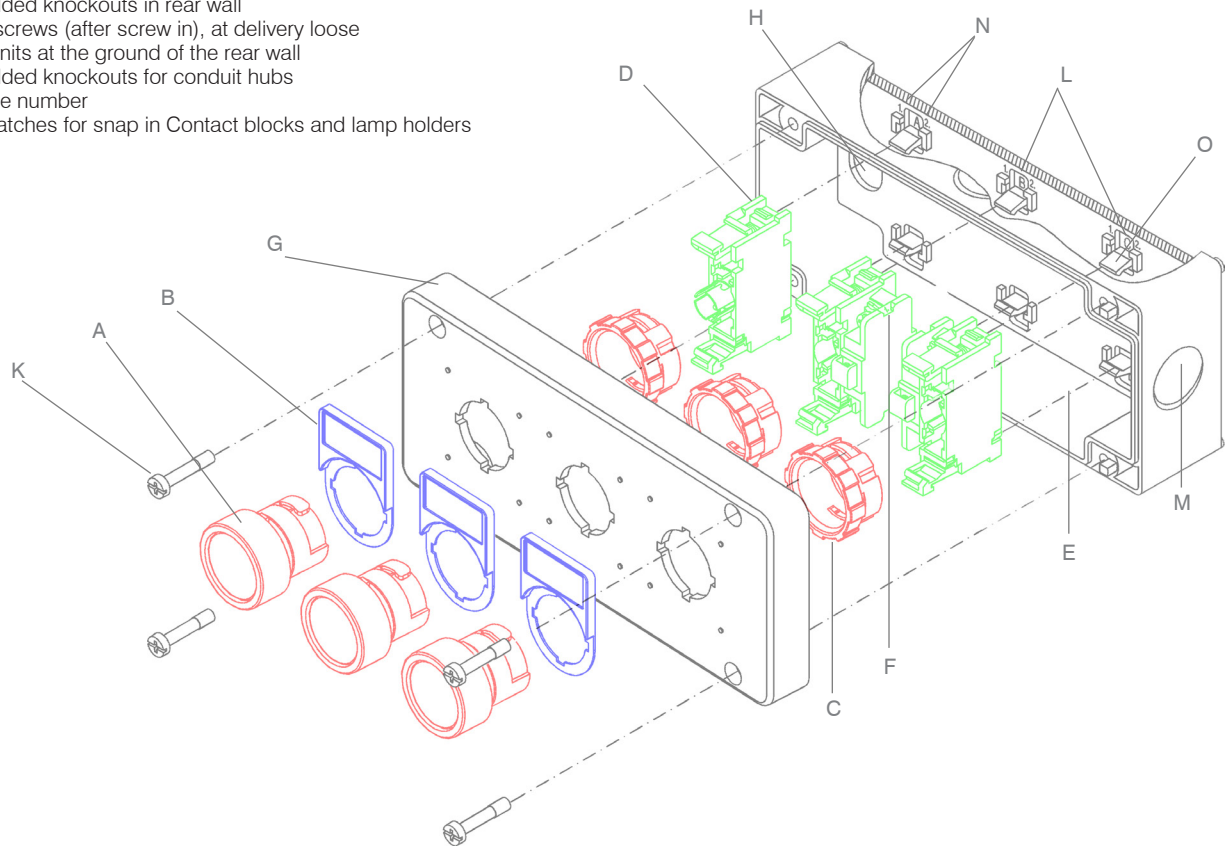

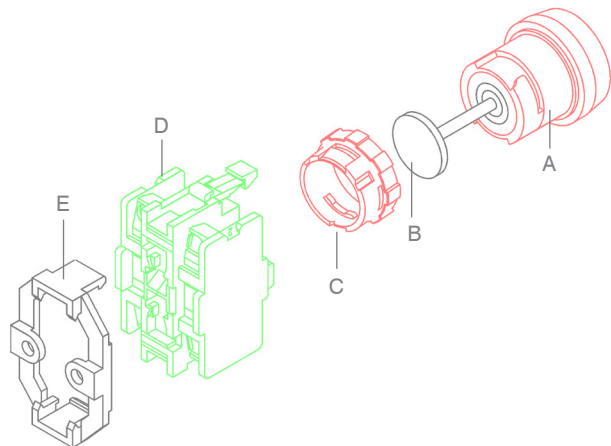

### Buttons for base mounting

- A Actuator Ø 22mm see page 325 – 328, Ø 30mm see page 337 – 339
- B Extension B4V...
- C Ring and nut (included with actuator or lens cap)
- D Contact block B4.. see page 344
- E Base B4U for base and DIN-rail mounting of contact blocks























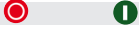
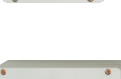
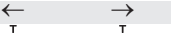





### Mounting Plate for base and DIN-rail mounting of contact blocks



		Type	Pack pcs.	Weight kg/pc.	
	Mounting Plate	for base and DIN-rail mounting of contact blocks and lamp holders	B4U	10	0,010
			B4.U...		
	Ring and Nut	for mounting former actuators and lens caps B4...	B3UP	10	0,004

# Assembled Stations IP67 (IP65) Type 12

For conduit entries are in top and both small sides only one knockouts for conduit hubs Ø20,5mm, for M20 or PG13,5 provided.

Type	Diagram	Diagram	Pack pcs.	Weight kg/pc.
<b>Plastic enclosed buttons and Pilot Lights</b>				
	ON push button green	 14 — 13	BG10 GN	1 0,135
	OFF push button red	 22 — 21	BG10 RT	1 0,135
	Pilot light green	x2 — ⊗ — x1	BG01 GN	1 0,135
	Pilot light red		BG01 RT	1 0,135
	Key operated 0 - I <sup>1)</sup> lock Ronis R455 60° maintained	 14 — 13	BG10SAR 0	1 0,165
	Key operated I - 0 - II <sup>1)</sup> lock Ronis R455 60° maintained	 14 — 13 24 — 23	BG10SARR 0	1 0,172
	2 push buttons 0 - I	 22 — 21 14 — 13	BG20	1 0,200
	2 push buttons ← →	 14 — 13 14 — 13 22 — 21 22 — 21	BG20PF	1 0,200
	3 push buttons ← 0 →	 14 — 13 22 — 21 14 — 13 22 — 21 22 — 21	BG30PF	1 0,283
	3 push buttons I - 0 - II	 14 — 13 22 — 21 14 — 13 22 — 21 22 — 21	BG30	1 0,283
	2 push buttons 0 - I with pilot light green	 x2 — ⊗ — x1 22 — 21 14 — 13	BG21 GN	1 0,270
	Foot and palm button mushroom Ø70mm	 14 — 13 22 — 21	BG10P14P GR	1 0,187
<b>Plastic enclosed EMERGENCY STOP buttons</b>				
	EMERGENCY STOP button head Ø40mm unlock by turning	 14 — 13 22 — 21	BG10P34-11	1 0,145
	EMERGENCY STOP mushroom button Ø40mm according to EN ISO 13850 unlock by pull	 14 — 13 22 — 21	BG10P44-11	1 0,145
	EMERGENCY STOP key operated button Ø40mm according to EN ISO 13850 unlock by key	 14 — 13 22 — 21	BG10P44S3-11	1 0,178
	EMERGENCY STOP mushroom button Ø70mm unlock by turning	 14 — 13 22 — 21	BG10P34P-11	1 0,187









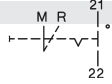

1) IP65

## Enclosures BG.. IP67, Type 12

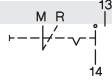

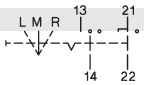

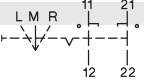

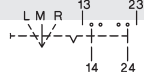







Number of units	Description	Type	Pack pcs.	Weight kg/pc.
1	3 knockouts Ø20,5mm (M20 or PG13,5)	BG1	1	0,108
1 yellow	3 knockouts Ø20,5mm (M20 or PG13,5)	BG1 GE	1	0,108
2	3 knockouts Ø20,5mm (M20 or PG13,5)	BG2	1	0,145
3	3 knockouts Ø20,5mm (M20 or PG13,5)	BG3	1	0,188

## Buttons and Lens Caps B3.. see page 331 -334

Contacts	Lamp voltage	Wiring diagram	actuators with 2 or 3 switch positions	Type	Pack pcs.	Weight kg/pc.
1NC <sup>1)</sup> 				B4TU01	10	0,015
1NO 				B4TU10	10	0,015
1NO+1NC <sup>1)</sup> 				B4TU11	10	0,022
2NC <sup>1)</sup> 				B4TU02	10	0,022
2NO 				B4TU20	10	0,022

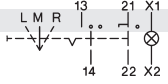
## Contact blocks with lamp holder, socket BA9s for LED or lamps, for enclosures BG.., lamps see page 347

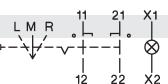

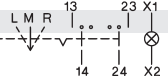
Contacts	Lamp voltage	Wiring diagram	actuators with 2 or 3 switch positions	Type	Pack pcs.	Weight kg/pc.
1NC <sup>1)</sup> 	max. 440V AC/DC			B4TU01F	10	0,020
1NO 	max. 440V AC/DC			B4TU10F	10	0,020
1NO+1NC <sup>1)</sup> 	max. 440V AC/DC			B4TU11F	10	0,027
2NC <sup>1)</sup> 	max. 440V AC/DC			B4TU02F	10	0,027
2NO 	max. 440V AC/DC			B4TU20F	10	0,027

## Lamp holder, socket BA9s for LED or lamps, lamps see page 345

max. 440V AC/DC	direct connection, for lamps max. 1,9W (take care for active power consumption)		X1 X2	B4FU	10	0,013
-----------------	---	---	----------	------	----	-------

1)  NC contact has a positive opening according to IEC/EN 60947-5-1

## Accessories for Plastic enclosed buttons



		Type	Pack pcs.	Weight kg/pc.
<b>Wrench</b>	for mounting of actuators and lens caps B(S)3..	<b>J7049</b>	1	0,018
<b>Couple Part</b>	to couple enclosures BKLG or assembled stations BG..	<b>B4-8852</b>	1	0,018

## Push Buttons for Enclosures 22mm IP65



### Push buttons grey RAL7035

Specification	Colour	Symbol	Length mm	Type	Pack pcs.	Weight kg/pc.
<b>Reset push button</b>	blue	R	8-22	<b>B2GRB-22</b>	10	0,005
	blue	R	22-60	<b>B2GRB-60</b>	10	0,016
<b>Reset push button with stop function</b>	red	0/R	8-22	<b>B2GR-22</b>	10	0,005
	red	0/R	22-60	<b>B2GR-60</b>	10	0,016
<b>Start push button</b>	green	I	8-22	<b>B2GI-22</b>	10	0,005
	green	I	22-60	<b>B2GI-60</b>	10	0,016
<b>Stop push button</b>	red	0	8-22	<b>B2G0-22</b>	10	0,005
	red	0	22-60	<b>B2G0-60</b>	10	0,016
<b>Mushroom head lockable Ø28mm</b>	red	0	8-22	<b>B2GP-22</b>	10	0,005
	red	0	22-60	<b>B2GP-60</b>	10	0,016

### Push buttons with metal ring and self adjusting extension pin



<b>Reset push button</b>	blue	R	19,5-38,5	<b>B3GRB-31,5</b>	10	0,023
	blue	R	38,5-60	<b>B3GRB-60</b>	10	0,026
<b>Reset push button with stop function</b>	red	0/R	19,5-38,5	<b>B3GR-31,5</b>	10	0,023
	red	0/R	38,5-60	<b>B3GR-60</b>	10	0,026
<b>Start push button</b>	green	I	19,5-38,5	<b>B3GI-31,5</b>	10	0,023
	green	I	38,5-60	<b>B3GI-60</b>	10	0,026
<b>Stop push button</b>	red	0	19,5-38,5	<b>B3G0-31,5</b>	10	0,023
	red	0	38,5-60	<b>B3G0-60</b>	10	0,026

Specification	Diameter Ø mm	Length mm	Type	Pack pcs.	Weight kg/pc.
---------------	---------------	-----------	------	-----------	---------------

### Extensions for push buttons



self adjusting pin, for B(S, C)3D.. and B(S, C)3P..	15	19,5 - 38,5	<b>B4V31,5</b>	10	0,001
	18,5	38,5 - 60	<b>B4V60</b>	10	0,004

# Technical Data

Terminal markings for control units according to DIN EN 50013

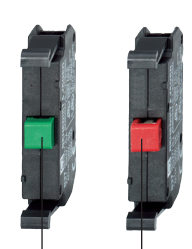
Distinc. number	Contact elements	Distinc. number	Contact elements	Distinc. number	Contact elements	Distinc. number	Contact elements	Distinc. number	Contact elements	Colour code
10	13 14							01	21 22	 NO Green      NC Red
20	13 23 14 24	11	13 21 14 22					02	11 21 12 22	
30	13 23 33 14 24 34	21	13 21 33 14 22 34	12	13 21 31 14 22 32			03	12 22 32 12 22 32	
40	13 23 33 43 14 24 34 44	31	13 21 33 43 14 22 34 44	22	13 21 31 43 14 22 32 44	13	13 21 31 41 14 22 32 42	04	11 21 31 41 12 22 32 42	

## Data according to IEC 947-5-1, VDE 0660, EN 60947-5-1



Type	B3T	B4T	
Rated insulation voltage $U_i$	V AC	690 <sup>1)</sup>	500
<b>Utilization category AC12</b> Control of resistive loads and solid stateloads with isolation by opto couplers			
Rated current $I_e$	220-240V A	10	10
	380-415V A	10	10
	500V A	10	10
	690V A	10	-
<b>Utilization category AC15</b> Control of electromagnetic load (>72VA)			
Rated current $I_e$	220-240V A	6	6
	380-415V A	5	5
	500V A	3	3
	690V A	2	-
<b>Utilization category DC12</b> L/R = 1ms Control of resistive loads and solid stateloads with isolation by opto couplers			
Rated current $I_e$	24V A	10	10
	60V A	6	6
	110V A	2,5	2,5
	220V A	0,8	0,8
<b>Utilization category DC14</b> L/R = 15ms Control of electromagnetic loads having economy resistors in circuit			
Rated current $I_e$	24V A	8	8
	60V A	1	1
	110V A	2	2
	220V A	0,5	0,5
<b>Utilization category DC13</b> L/R = 300ms Control of electromagnets			
Rated current $I_e$	24V A	2	2
	60V A	5	5
	110V A	0,5	0,5
	220V A	0,2	0,2
Making capacity	A	60	60
Breaking capacity $\cos\phi = 0,7-1$	40-60Hz A	50	50
Mechanical life	10 <sup>5</sup> operations	3	3
Contact life (AC15)			
100VA	10 <sup>5</sup> operations	2,5	2,5
300VA	10 <sup>5</sup> operations	2	2
800VA	10 <sup>5</sup> operations	1,5	1,5
1200VA	10 <sup>5</sup> operations	1	1
Maximum frequency of operations	ops. per hour	60	60
Short circuit protection	slow, gL (gG) A	25	25
Type		B3F	B4F
Rated insulation voltage $U_i$	V AC	440 <sup>2)</sup>	440 <sup>2)</sup>
Lamp base		BA9s	

Type	B3., B4., B5.
Protection degree (according to IEC 947-1) in assembled state, from the front from rear	IP67/IP65 IP20/IP00
Ambient temperature Operation	open °C -40 to +60 <sup>3)</sup> enclosed °C -40 to +40
Storage	°C -50 to +90
Cable cross-section	 solid, mm <sup>2</sup> 0,5 - 2,5 flexible, mm <sup>2</sup> 0,5 - 2,5 flexible with multicore cable end, mm <sup>2</sup> number 0,5 - 1,5
Cables per clamp	2
Mounting hole (according to IEC 947-1)	Ø mm 22,5 Ø mm 30,5
Mounting position	optional
Terminal screws	Pozidriv No. 2 screws M3,5

## Data according to cULus

Type	B3.	B4.
Contact Block for NO and NC	600 V AC max.	600 V AC max.
General use	10A	10A
Heavy pilot duty	A600	A600
Lamp Holder with socket BA9s	240V 2,6W max.	240V 2,6W max.
Wire (Contact and lamp holder) Torque	14 - 18AWG 9 lb/in.	14 - 18AWG 9 lb/in.

## Approvals

Country	USA, Canada UL	Europe	Register of Shipping	CENELEC CB-Certificates
Type			Great Britain LRS	
B3T..	o	o	-	o
B3F..	o	o	-	o
B4TU..	o	o	o	o
B4T..UF	o	o	o	o
B4FU..	o	o	o	o
B3-MB..	-	o	-	-

o In standard version approved

- Not provided for test till now

1) Suitable for: earthed-neutral systems, overvoltage category I to IV, pollution degree 3 (standard-industry):  $U_{mp} = 6kV$ .

Data for other conditions on request.

2) Suitable for: earthed-neutral systems, overvoltage category I to III, pollution degree 3 (standard-industry):  $U_{mp} = 4kV$

3) Ambient temperatures for lamps find on pages 337, 341, 349.

# Dimensions

## Actuators and Lens Caps 22mm

Panel mounting B3S

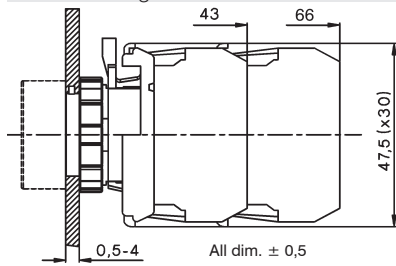

Panel mounting B3M

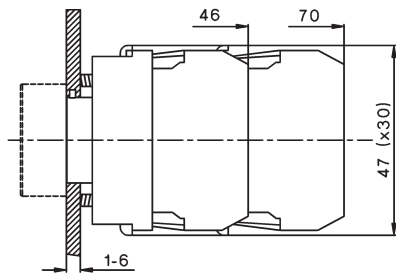

Mounting holes

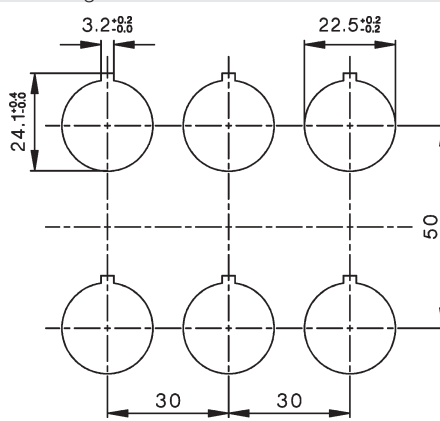

Dimensions of minimum space requirements according to IEC. Take to consideration the field of traverse of swing knobs (27mm) and the diameter of mushroom heads.

Contact blocks and Lamp Holder B3...

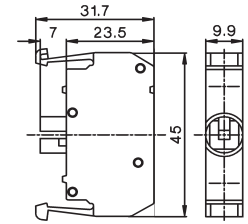

All dim. ± 0,2

Contact block B3T...

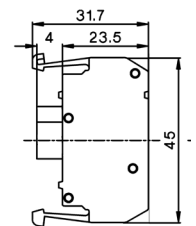

All dim. ± 0,2

### Actuators and Lens caps

Flush Head  
Illuminated Flush Head

B3D(R), B3DL(R)  
BS3D(R), BS3DL(R)  
BC3D(R), BC3DL(R)

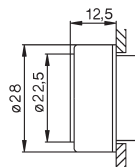

All dim. ± 0,5

Mushroom Head Ø28mm  
Emergency Stop Ø28mm

B3P1 bis B3P3  
BS3P1 bis BS3P3  
BC3P1 bis BC3P3

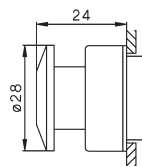

Mushroom Head Ø40mm  
Emergency Stop Ø40mm

B3P14, B3P34  
BS3P14, BS3P34  
BC3P14, BC3P34

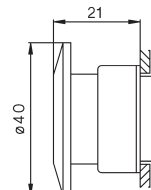

All dim. ± 0,5

Mushroom Head Ø70mm  
Emergency Stop Ø70mm

BS3P14P  
BS3P34P

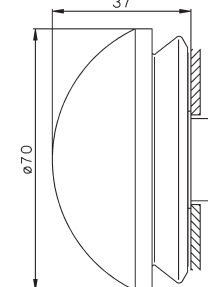

Push-and pull button Ø40mm

BS3P44

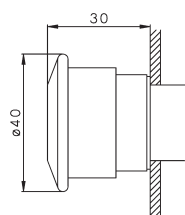

Push-and pull button Ø40mm

BS3P45

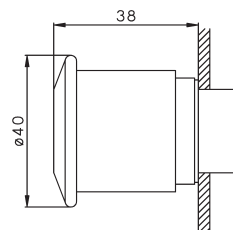

Push-and pull button Ø40mm  
with key  
BS3P44S3

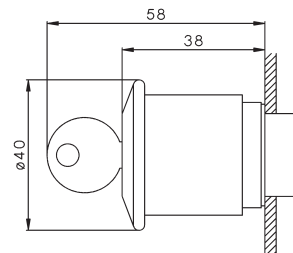

Lockable Push button

B3SAR., B3SAT.  
BS3SAR., BS3SAT.  
BC3SAR., BC3SAT.

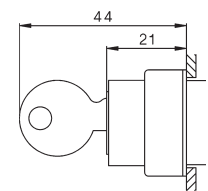

Toggle

B3E  
BS3E  
BC3E

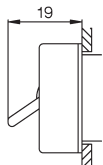

Rotary Knob

B3KN, B3KL  
BS3KN, BS3KL  
BC3KN, BC3KL

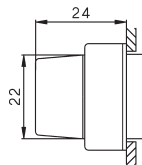

Swing Knob

B3KRL, B3KRN  
BS3KRL, BS3KRN  
BC3KRL, BC3KRN

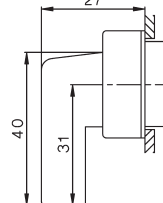

Lens Cap

B3R(F) B3RN

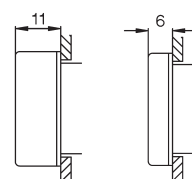

# Dimensions

## Actuators and Lens Caps 22mm

Double push button      Monoblock Multi-LED      Protection cover      Protection ring w. thread

B3DT

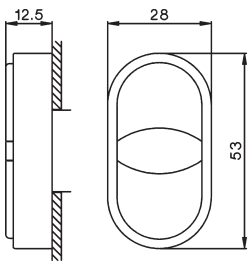

B3-MB...

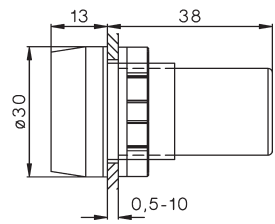

B3-SK ..

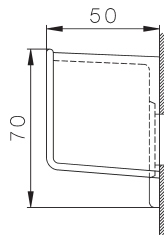

All dim. ± 0,5

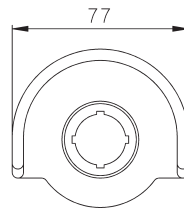

All dim. ± 0,5

P921-.

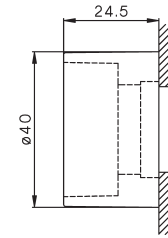

Label holder

Legend plate

Label holder

Label holder

Legend plate

P751

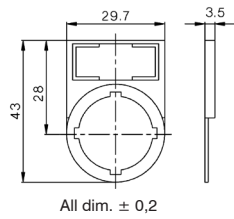

All dim. ± 0,2

BK4-...

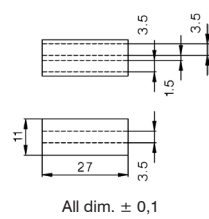

All dim. ± 0,1

P761

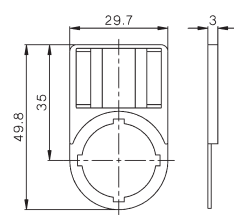

P761-DT

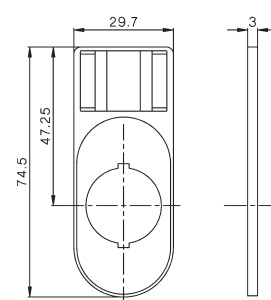

BK8-...

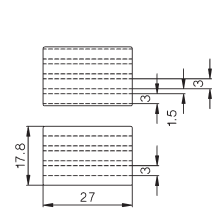

# Dimensions

## Actuators and Lens Caps 30mm

Panel mounting B3S

Mounting holes

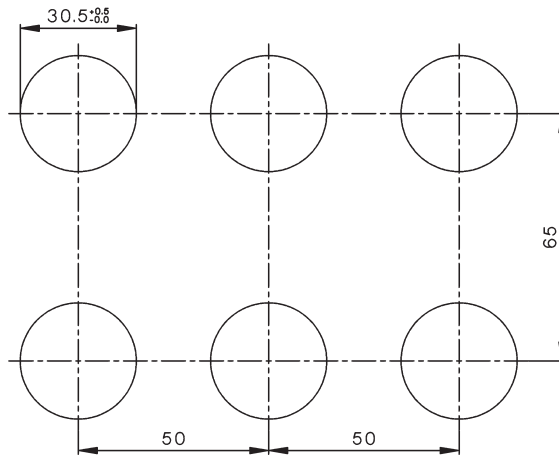
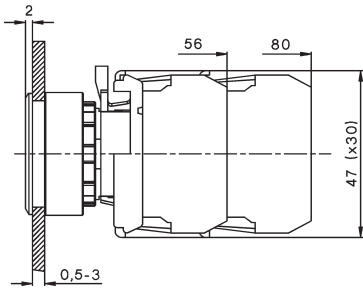

## Actuators and Lens caps

Flush Head Illuminated Flush Head	Mushroom Head Ø28mm Emergency Stop Ø28mm	Mushroom Head Ø40mm Emergency Stop Ø40mm	Lens Cap
--------------------------------------	---	---	----------

B5D(R), B5DL(R)  
BS5D(R), BS5DL(R)

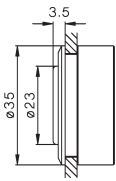

B5P1 to B5P3  
BS5P1 to BS5P3

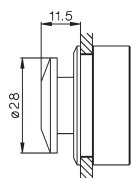

Mushroom Head Ø40mm  
Emergency Stop Ø40mm

B5P14, B5P34  
BS5P14, BS5P34

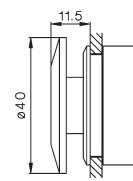

Lens Cap

B5RF

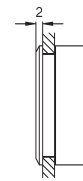

Toggle

B5E  
BS5E

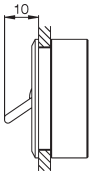

Rotary Knob

B5KN, B5KL  
BS5KN, BS5KL

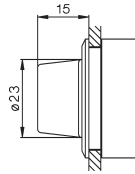

Swing Knob

B5KRL, B5KRN  
BS5KRL, BS5KRN

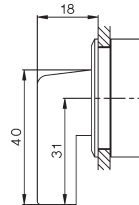

Lockable Push button

B5SAR., B5SAT.  
BS5SAR., BS5SAT.

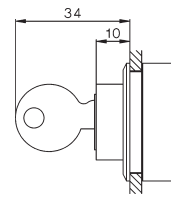

Label holder

P942-1

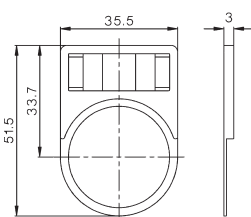

Legend plate

BK5-...

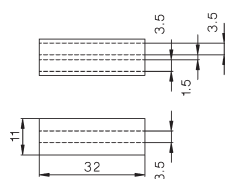

Label holder

P1043

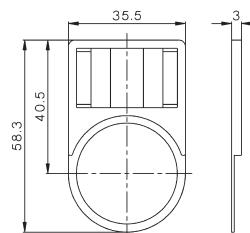

Legend plate

BK10-..

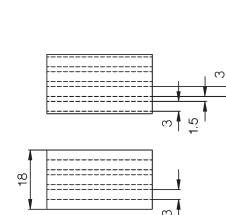

# Dimensions

Protective Cover  
B5-SAP

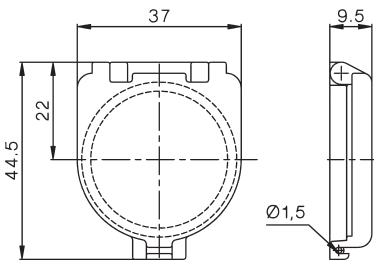

## Enclosures for Custom Built Stations

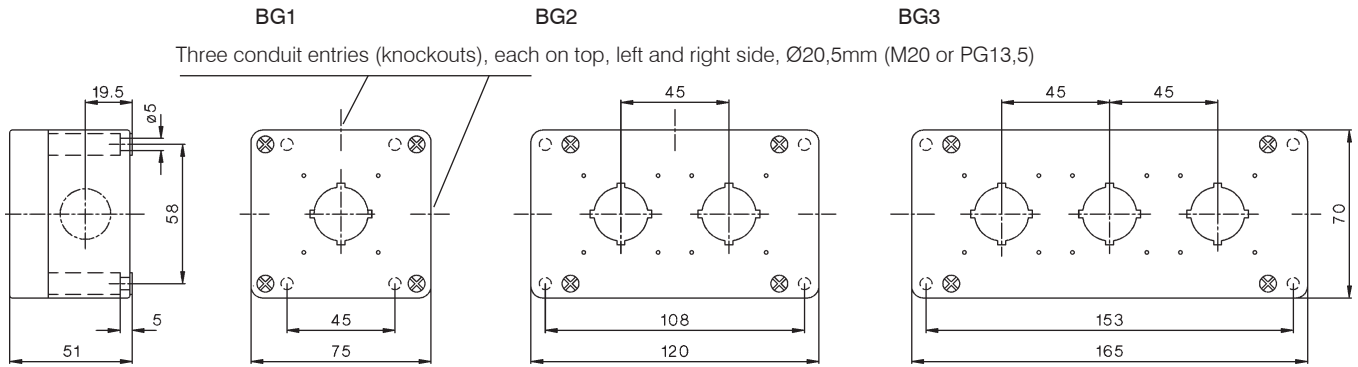

Conduit entries in the bottom  
(knockouts)

Coupled Enclosures  
B4-8852

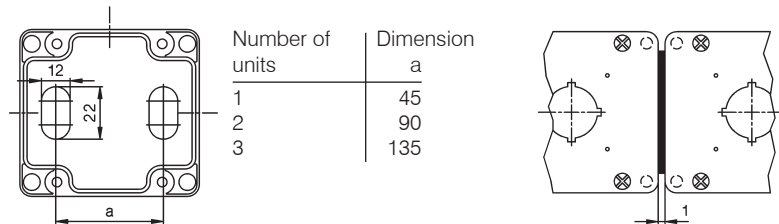

## EMERGENCY STOP Push Button Ø40 mm

BG10P44

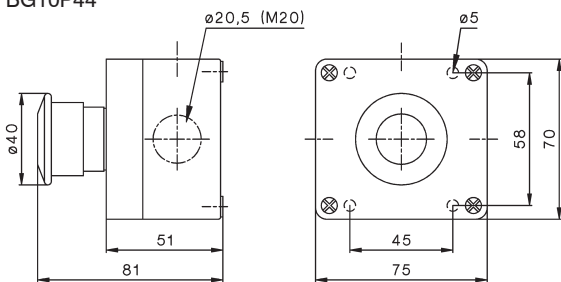

## EMERGENCY STOP Push Button Ø70 mm, Foot switch

BG10P34P, BG10P14P

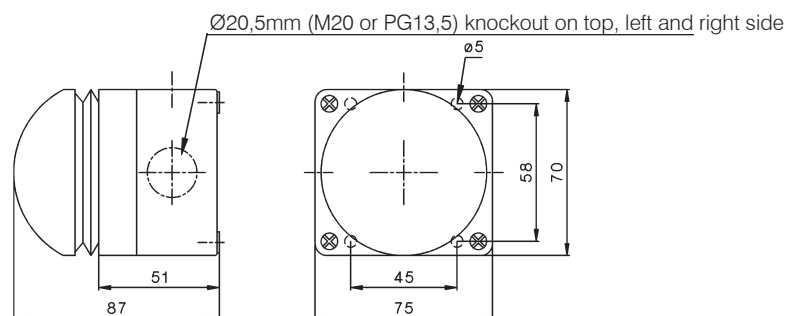

# Dimensions

## Actuators 22mm

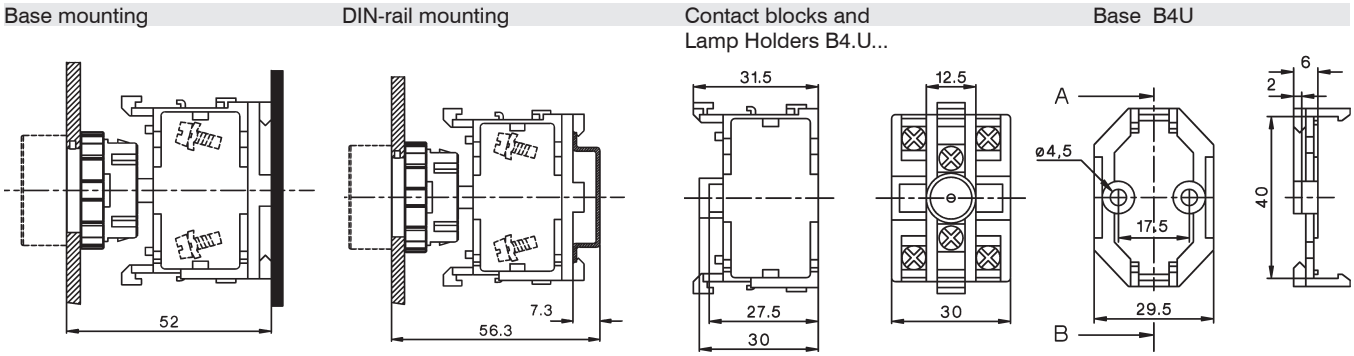

## Push buttons for enclosures

### B2G..-22

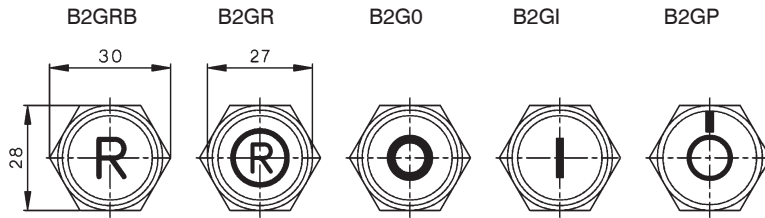
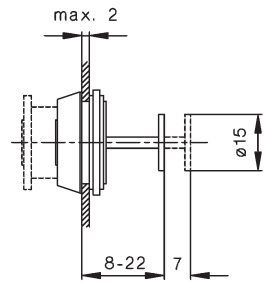

### B2G..-60

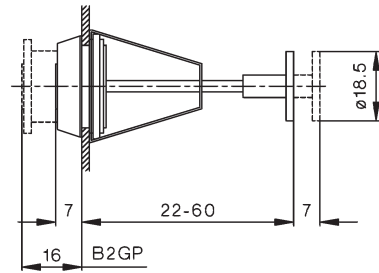

### B3G..-31,5

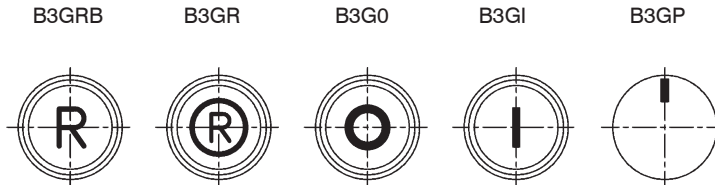
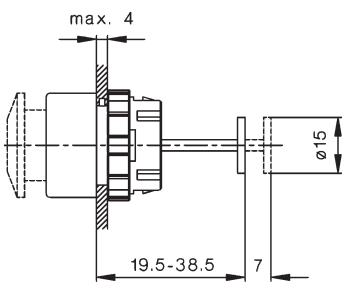

### B3G..-60

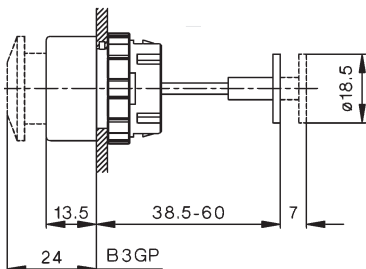

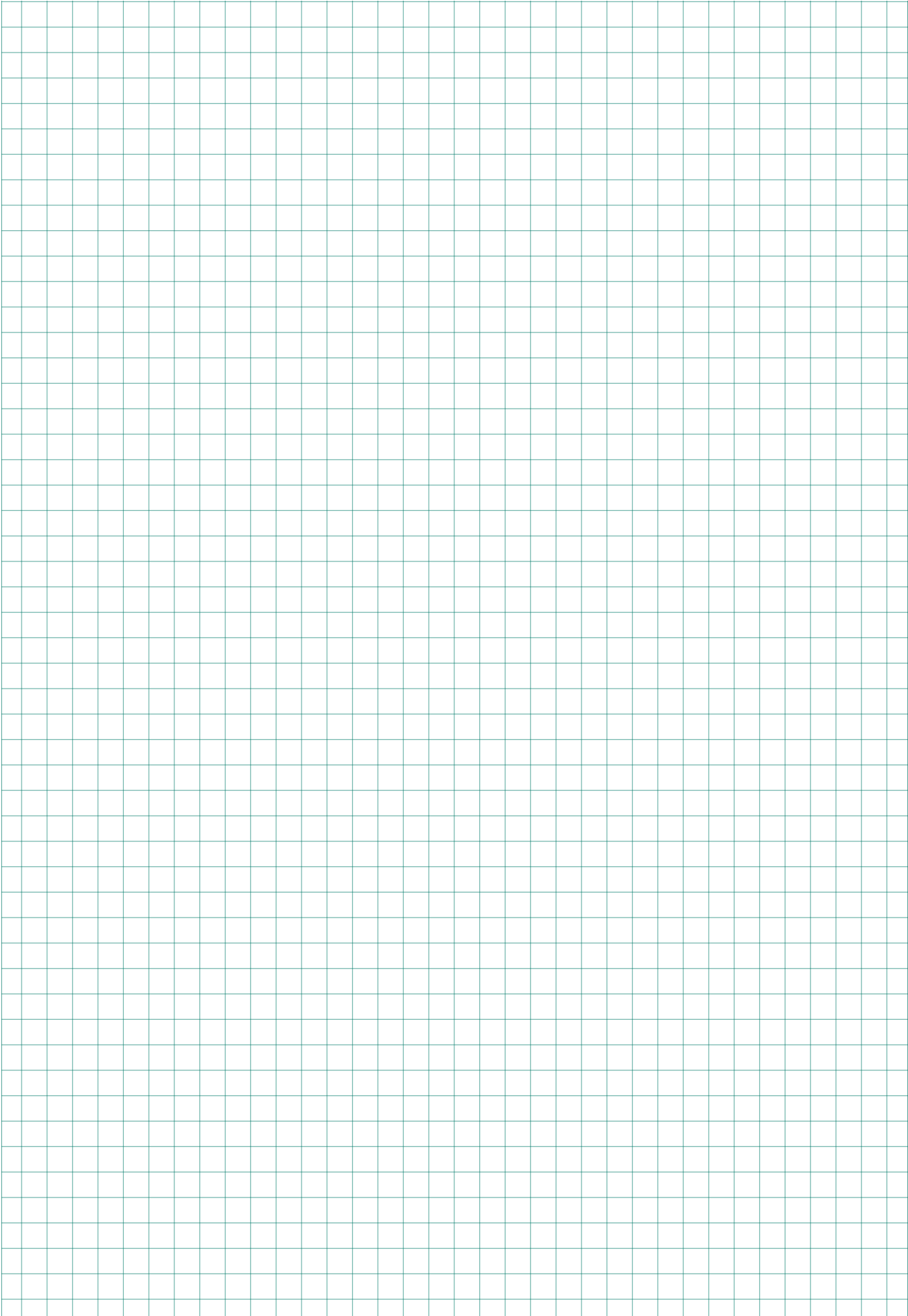

# European Representatives and Suppliers

## Austria

**Kiechel & Hagleitner GmbH & Co KG** Tel: +43 / 5574 / 4970-53  
Quellenstraße 20-22 Fax: +43 / 5574 / 4970-20  
6900 Bregenz monika.simma@kiha.at  
Representation for Vorarlberg www.kiha.at

**Stenna GmbH** Tel: +43 512 209 086  
Reut - Nicolussi - Strasse 10 Fax: + 43 512 209 086 40  
6020 Innsbruck office@stenna.at  
Representation for Tirol, South Tirol www.stenna.at

**Seitner & Bittmann** Tel: +43 / 316 / 82 35 62  
Kossgasse 21 Fax: +43 / 316 / 82 35 65  
8035 Graz info@seitner-bittmann.at  
Representation for Styria www.seitner-bittmann.at

**Seitner & Bittmann** Tel: +47 / 463 / 38 10 70  
Kirchengasse 11 Fax: +47 / 463 / 38 10 72  
9020 Klagenfurt info@seitner-bittmann.at  
www.seitner-bittmann.at

**STARA Elektrogroßhandel GmbH** Tel: +43 / 732 / 380841-0  
Hollaberstraße 7 Fax: +43 / 732 / 380841-24  
4020 Linz verk.li@stara.at  
www.stara.at

**Gebrüder LMMERT AG** Tel: +43 / 662 / 88933-0  
Samergasse 30a Fax: +43 / 662 / 881254  
Postfach 168 verkauf-allgemein@lmmert.com  
5020 Salzburg www.lmmert.com

**GFI Elektrofachgroßhandel** Tel: +43 / 1 / 7265200-0  
Oberlaaer Straße 285 Fax: +43 / 1 / 7265200-20  
1230 Wien servicecenter@gfi-austria.at  
www.gfi-elektro.at

**Sonepar Österreich GmbH** Tel: +43 / 1 / 291 26-0  
Prager Strasse 243 Fax: +43 / 1 / 291 26-835  
1210 Wien www.sonepar.at

**REGRO Elektro-Grosshandel GmbH** Tel: +43 / 5 / 734 76-0  
Muthgasse 26/5 Fax: +43 / 5 / 734 76-58082  
1190 Wien www.regro.at

**Rexel Austria GmbH** Tel: +43 / 1 / 688 0 388 30  
Murbangasse 1 office@rexel.at  
1100 Wien www.rexel.at

**Schäcke Elektrogroßhandels-  
gesellschaft m.b.H.** Tel: +43 / 5 / 01210 13  
Murbangasse 1 www.schaecke.at  
1100 Wien

**Sonepar Österreich GmbH** Tel: +43 / 51706-0  
Großmarktstraße 7b Fax: +43 / 51706-70500  
1230 Wien info@sonepar.at  
www.sonepar.at

**STARA Elektrogroßhandels GmbH** Tel. Linz: +43 / 732 / 380841-0  
Autokaderstraße 31 Fax Linz: +43 / 732 / 380841-24  
1210 Wien wien@stara.at  
Tel. Vienna: +43 / 1 / 6992619-0 verk.li@stara.at  
Fax Vienna: +43 / 1 / 6992619-18 verw.li@stara.at  
www.stara.at

**TEG GmbH** Tel: +43 / 1 / 5 96 36 92  
Richard-Strauss-Str. 15 Fax: +43 / 1 / 5 96 36 92 92  
1230 Wien office@teg.at  
www.teg.at

## Belgium

**Teconex** Tel: +32 / 4 / 358 85 75  
Matériel Electrique info@teconex.be  
Rue de Magnée 108 www.teconex.eu  
B - 4610 Beyne-Heusay

## Bulgaria

**Schrabul Ltd** Tel: +359 / 02 / 958 76 54  
Yordan Yovkov Str. 8 Fax: +359 / 02 / 958 59 95  
BG - 1408 Sofia info@schrabul.com  
www.schrabul.com

## Croatia

**Stirel Promet d.o.o.** Tel: +385 / 1 / 364 9260  
Ulica Vladimira Varicaka 3 Fax: +385 / 1 / 364 9360  
HR - 10000 Zagreb info@stirel-promet.hr  
www.stirel-promet.hr

**Tipteh d.o.o. Zagreb** Tel: +385 / 1 / 314 1550  
Ratarska 35 Fax: +385 / 1 / 314 1551  
HR - 10000 Zagreb tipteh@tipteh.hr  
www.tipteh.hr

## Cyprus

**M. Hadjioannou Ltd.** Tel: +357 / 22 / 348 262  
Electrotechnical & Lighting Specialists Fax: +357 / 22 / 430 107  
Aegeos 8c, Pallouriotissa milton@spidernet.com.cy  
CY - Nicosia

## Czech Republic

**DNA Energie spol s.r.o.** Tel: +420 / 327 316 339  
Kmochova 406 Fax: +420 / 327 316 405  
CZ - 280 02 Kolin 2 martin.pecha@dna.cz  
www.dna.cz

## Denmark

**MTO electric a/s** Tel: +45 / 75 800 310  
Stiftsvej 14 Fax: +45 / 75 800 320  
DK - 7100 Vejle info@mto-electric.dk  
www.mto-electric.dk

## Finland

**UTU Powel Oy** Tel: +358 / 9 / 274 64 128  
Valimotie 26B Fax: +358 / 9 / 274 64 141  
PL 252 harri.paivarinta@utu.eu  
FIN - 01531 Vantaa www.utu.eu

## France

**Teconex** Tel: +32 / 4 / 358 85 75  
Matériel Electrique  
Rue de Magnée 108 info@teconex.be  
B - 4610 Beyne-Heusay www.teconex.eu

## Germany

**TVB - ENERGIE GmbH** Tel: +49 / 4151 / 87967 11  
Wiesenweg 10 Fax: +49 / 4151 / 87967 69  
D - 21493 Schwarzenbek www.tvb-energie.de  
info@tvb-energie.de

*Representation for Schleswig-Holstein, Hamburg, Mecklenburg-  
Vorpommern, Niedersachsen*

**ELWATEG Elektrohandel GmbH & Co KG**  
Am Südfeld 7 Tel: +49 / 4441 / 9170 0  
D - 49377 Vechta Fax: +49 / 4441 / 9170 70  
www.elwateg.de  
vertrieb@elwateg.de

*Representation for Niedersachsen: Vechta, Cloppenburg, Diepholz,  
Osnabrück, Oldenburg, Bremen, Emsland*

**Rudolf Kiesewetter Messtechnik GmbH**  
Eisbachstraße 51 Tel: +49 / 7976 / 21 00 390  
D - 74429 Sulzbach-Laufen Fax: +49 / 7976 / 21 00 391  
info@kiesewetter-mt.de  
www.kiesewetter-mt.de

*Representation for Brandenburg, Sachsen-Anhalt, Sachsen, Thüringen*

**Wagner GmbH**  
Elektrotechnische Systemlösungen  
Robert-Bosch-Straße 35  
D - 42489 Wülfrath  
*Representation for Nordrhein-Westfalen, Rheinland-Pfalz, Saarland*

Tel: +49 / 2058 / 782 800-0  
Fax: +49 / 2058 / 752 800-49  
info@wagnergmbh.de  
www.wagnergmbh.de

**BRETZEL GmbH**  
Antriebs- und Elektrotechnik  
Am Rotböhl 8  
D - 64331 Weiterstadt  
*Representation for Hessen*

Tel: +49 / 6150 / 86560 - 0  
Fax: +49 / 6150 / 86560 - 69  
kilper@bretzel-gmbh.de  
www.bretzel-gmbh.de

**SBV - Gawehn GmbH**  
Industrievertretungen  
Zollnerstraße 2  
D - 90579 Langenzenn  
*Representation for Bayern*

Tel: +49 / 9101 / 9099-0  
Fax: +49 / 9101 / 9099-30  
vertrieb@gawehn.com  
www.gawehn.com

**Schad SinTec GmbH**  
Heinkelstr. 29  
D - 73230 Kirchheim/Teck  
*Representation for Baden Württemberg*

Tel: +49 / 7021 / 95095-0  
Fax: +49 / 7021 / 95095-40  
info@schad.de  
www.schad.de

## Great Britain

**IMO Precision Controls Ltd.**  
The Interchange 7530  
Frobisher Way, Hatfield  
GB - AL10 9TG Hertfordshire

Tel: +44 / 0 / 1707 414 444  
Fax: +44 / 0 / 1707 414 445  
imo@imopc.com  
www.imopc.com

## Greece

**Geyer Hellas s.a.**  
Electrical and Electronic Material  
PO Box 19038  
GR - 34100 Drosia-Chalkis

Tel: +30 / 22210 / 987 11  
Fax: +30 / 22210 / 987 12  
info@geyer.gr  
www.geyer.gr

## Hungaria

**DIAL-COMP Kft.**  
Kámfor u. 31. a-b  
HU - 1131 Budapest

Tel: +36 / 1 / 236 0427  
Fax: +36 / 1 / 236 0430  
info@dialcomp.hu  
www.dialcomp.hu

## Italy

**SIF srl**  
Via del Carraccio 104 - 106  
IT - 24040 Stezzano

Tel: +39 / 35 / 592 931  
Fax: +39 / 35 / 455 93 58  
info@sifmdc.com

## Netherlands

**Hirsch-Driebergen B.V.**  
Postbus 143  
NL - 3970 AC Driebergen

Tel: +31 / 343 / 51 55 34  
Fax: +31 / 343 / 52 03 14  
info@hirsch-driebergen.nl  
www.hirsch-driebergen.nl

## Norway

**Gyilling Teknikk AS**  
P. O. Box 103  
Rudssletta 71  
NO - 1351 Rud

Tel: +47 / 67 / 15 14 00  
Fax: +47 / 67 / 15 14 01  
gyilling@gyilling.no  
www.gyilling.no

## Poland

**ASTAT Sp. z o.o.**  
ul. Dabrowskiego 441  
PL - 60-451 Poznań

Tel: +48 / 61 / 848 88 71  
Fax: +48 / 61 / 848 82 76  
info@astat.com.pl  
www.astat.com.pl

## Portugal

**Jayme da Costa**  
Mecanica e Electricidade, S.A.  
Rua de Murraceses, 216  
PT - 4416 - 901 Pedroso

Tel: +351 / 22 / 74 70 250  
Fax: +351 / 22 / 76 40 548  
ae@jaymedacosta.pt  
www.jaymedacosta.pt

## Romania

**Megatech Trading & Consulting SRL**  
Str. Buzesti 61, Bl.A6, Sc. 1, Et.6  
RO - Bukarest 1

Tel: +40 / 21 / 317 05 68  
Fax: +40 / 21 / 317 05 68  
sales@megatech.ro  
www.megatech.ro

## Russia

**Poligon**  
офис 501, ул. Льва Толст  
197376 Санкт-Петербург  
Россия

Tel: +7 / 812 / 335 3665  
Fax: +7 / 812 / 325 4220  
www.poligon.info

**TsUP CheAZ**  
(CheAZ Center for Project  
Management)  
11 Bol. Sawinskiy pereulok  
RU - 119435 Moskau

Tel: +7 495 6603100  
Fax: +7 495 6602138  
info@cfpm.ru  
www.cheaz.ru

## Slovakia

**DNA Slovakia s.r.o.**  
Komáròanská cesta 13  
SK - 940 43 Nové Zámky

Tel: +35 / 6400 616, 6426 824  
Fax: +35 / 6401 907  
info@dnaslovakia.sk  
www.dnaslovakia.sk

## Slovenia

**Tipteh d.o.o.**  
Ulica Ivana Roba 21  
SI - 1000 Ljubljana

Tel: +386 / 1 / 200 51 50  
Fax: +386 / 1 / 200 51 51  
info@tipteh.si  
www.tipteh.si

## Spain

**CYDESA**  
Pol. Ind. Sant Antoni  
Parcela 2, Nave A  
ES - 08620 Sant Vicenc dels Horts

Tel: +34 / 93 / 656 59 50  
Fax: +34 / 93 / 676 97 45  
cydesa@cydesa.com  
www.cydesa.com

## Sweden

**Wallin & Co AB**  
Götlundagatan 10  
SE - 12471 Bandhagen

Tel: +46 / 8 / 860 102  
Fax: +46 / 8 / 997 050  
info@wallin-co.se  
www.wallin-co.se

## Switzerland

**BENEDICT Swiss AG**  
Grindelstraße 19  
CH - 8303 Bassersdorf

Tel: +41 / 44 / 213 66 00  
Fax: +41 / 44 / 213 66 09  
office@benedict-swiss.ch  
www.benedict-swiss.ch

## Serbia and Montenegro

**Tipteh d.o.o. Beograd**  
Ulica Mose Pijade 17A  
RS - 11224 Vrcin

Tel: +381 / 11 / 31 31 057  
Fax: +381 / 11 / 30 18 326  
office@tipteh.rs  
www.tipteh.rs

## Turkey

**ERGUN ELEKTRIK Co Ltd.**  
Kazim Dirik Mahallesi  
Sanayi Caddesi No: 66  
TR - 35100 Bornova, Izmir

Tel: +90 / 232 462 72 00  
Fax: +90 / 232 462 72 04  
ergun@ergunelektrik.com  
www.ergunelektrik.com

# Oversea Representatives and Suppliers

## Australia

**IMO Pacific Pty Ltd**  
1/6 Dillington Pass  
Landsdale  
WA 6065  
Australia  
Tel: +61 / 08 / 9302 5246  
Fax: +61 / 8 / 9303 9908  
sales@imopacific.com.au  
www.imopacific.com.au

## Argentina

**RHONA Argentina**  
Bahia Blanca #5675,  
(1650) Munro, Vicente Lopez,  
Provincia de Buenos Aires  
Argentina  
Tel: +54 / 11 / 204 63 64  
www.rhona.com.ar

## Bahrain

**Almadar General Trading Est.**  
POB: 15268  
BHR - Kingdom of Bahrain  
Tel: +973 / 1778 9600  
Fax: +973 / 1787 7366  
aj@almadartrading.com  
www.almadartrading.com

## Bolivia

**Agencias Generales S.A.**  
Calle Bolivar E-520  
BO - 0253 Cochabamba  
Tel: +591 / 04-4251062  
Fax: +591 / 4-4251062  
arturo@agsa.com  
www.agsa.com

## Canada

**BROOK CROMPTON LTD:**  
264 Attwell Drive  
Toronto, ON  
CDN - M9W 5B2  
Tel: +1 / 416 / 675 38 44  
Fax: +1 / 416 / 675 68 85  
david.tomlinson@brookcrompton.com  
www.brookcrompton.com

## Chile

**RHONA S.A.**  
Agua Santa 4211  
Vina del Mar  
Chile  
Tel: +56 / 32 / 2320600  
info@rhona.cl  
www.rhona.cl

## Egypt

**Economic Co.**  
Electrical Commerce & Import  
44, Naguib El-Rihani St.  
ET - Kairo  
Tel: +20 / 02 / 592 91 80  
Fax: +20 / 02 / 590 78 82  
economic@economic-ec.com

## Hong Kong

**Creation Building Services  
Materials Limited**  
Unit A & B, 15th Floor, Worldwide Centre  
123 Tung Chau Street, Tai Kok Tsui,  
Kowloon  
Hong Kong - China SAR  
Tel: +852 / 2398 2106  
Fax: +852 / 2191 5808  
sales@creation-trading.com  
www.creation-trading.com

## Jordan

**Jordanian Electro-Techniques**  
Complex No. 189, Salah Al Deen  
Al Ayoubi St. 189  
JO - Amman  
Tel: +962 / 6 / 463 2320  
Fax: +962 / 6 / 463 2321  
jetco@jetco-jo.com

## Kenia

**G.F. Corvin Ltd.**  
P.O. Box 30747  
00100 Nairobi  
Kenia  
Tel: +254 / 20 / 856 06 08  
Fax: +254 / 20 / 856 19 74  
gecor@africaonline.co.ke

## Lebanon

**Industrial Technologies. S.A.L. (itec)**  
Afrah PLAZA Center  
Blvd Fouad Chehab,  
Sin El Fil, Beirut  
Tel: +961 / 1 491 161  
Fax: +961 / 1 491 162  
info@iteclb.com  
www.iteclb.com

## Mexico

**B&J USA Inc.**  
120-101 North Tech Drive  
Post Office Box 877  
Clayton, N.C. 27528  
Tel: +1 / 800 989 7357  
Fax: +1 / 919 / 553 5565  
sales@bnj-usa.com  
www.bnj-usa.com

## New Zealand

**Eurotec Instruments Ltd.**  
P.O.Box 14-543 Panmure  
750 Gt South Rd, Penrose  
NZ - Auckland  
Tel: +64 / 9 / 579 1990  
Fax: +64 / 9 / 525 3334  
sales@eurotec.co.nz  
www.eurotec.co.nz

## Peru

**RHONA Peru S.A.C.**  
Av. Argentina 2201  
Cercado de Lima  
Peru  
Tel: +51 / 1 / 464 44 59  
www.rhona.pe

## Singapore

**Mecomb Singapore Ltd.**  
04-02 Sime Darby Center  
896 Dunearn Road  
SGP - 589472 Singapore  
Tel: +65 / 646 / 98 833  
Fax: +65 / 646 / 71 905  
sales.msl@simedarby.com.sg

## South Africa

**Deebar**  
Mining & Ind. Supplies  
P.O. Box 40325  
RSA - 2022 Cleveland  
Tel: +27 / 21 / 873 43 32  
Fax: +27 / 21 / 825 69 84  
sales@deebar.co.za

## Electric Assemblies

Unit 2A Simplex Ind. Park  
Engine Road,  
RSA - 7441 Cape Town  
Tel: +27 / 21 / 52 3023  
Fax: +27 / 21 / 52 2704  
davecpt@mweb.co.za

## Syria

**T. S. Boyadjian**  
Electrical Equipments  
Halbouni Street no. 9  
P.O. Box 2822  
SYR - Damascus  
Tel: +963 / 11 / 221 14 45  
Fax: +963 / 11 / 221 67 45  
tsboyadjian@excite.com

## Taiwan

**VINMAJOR ENTERPRISE Co., Ltd.**  
8F-2, No. 306, Section 1, Ta-Tung Road  
Hsi-Chih, Taipei Hsien  
R.O.C. Taiwan  
Tel: +886 / 2 / 2643 6183  
Fax: +886 / 2 / 8691 6288  
vin.major@msa.hinet.net

## Thailand

**Maximize Integr. Technology Co., Ltd.**  
15/25 Moo 5 Ratchapruerk Rd.  
Tambol Bangraknoi  
AmphurMaungnonthaburi Notnhaburi 11000  
Tel: +662 / 194 8738 - 9  
Fax: +662 / 003 2215  
siriwat.k@mit-thailand.com

## USA

**B&J USA Inc.**  
120-101 North Tech Drive  
Post Office Box 877  
Clayton, N.C. 27528  
Tel: +1 / 800 989 7357  
Fax: +1 / 919 / 553 5565  
sales@bnj-usa.com  
www.bnj-usa.com

## Zimbabwe

**Star Delta Electrix**  
No 2 Bristol Road South  
Belmont East  
P.O. Box 3592  
ZW - Bulawayo  
Tel: +263 / 9 / 715 24  
Fax: +263 / 9 / 764 75  
info@stardelta.co.zw  
www.stardelta.net

# Oversea Representatives and Suppliers

---